

Cautions and Warnings

Please be noted that this spec is only for reference if you have projects designed with the product number listed in. If you are looking for new project design-in, please find BPSC Series specification/datasheet on Chilisin website. Or you may find our sales contact for more information on old part number at your convenience. Appreciated your attention and understanding.

Note: Please be sure to request approval specifications that provide further details of the products. Kindly note that the content of these specifications are subject to change or may be discontinued without prior notice. This product may not be designed/used in medical or high risk applications without Chilisin approval. Please contact our sales department before ordering.

SCDS Series

Features

- RoHS, Halogen Free and REACH Compliance
- Magnetic shielded
- Various package size and wide inductance range

Applications

- AP Routers
- STBs
- LCD TVs and monitors
- Game consoles
- LED lightings
- DC/DC converters

Product Identification

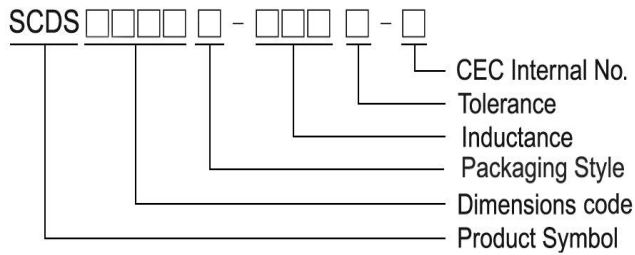

- T : Packaging: Tape and Reel

SCDS 73/ 74

Shape and Dimensions

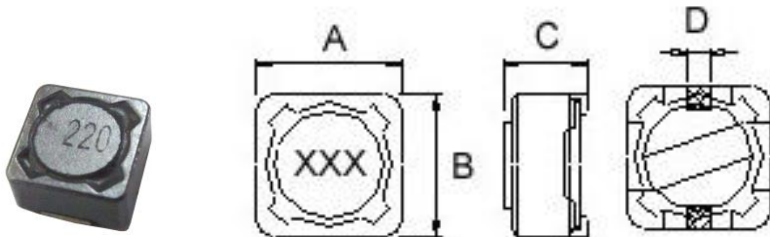

Dimension in mm

| TYPE | A | B | C | D |
|--------|---------|---------|-------------------|-----|
| SCDS73 | 7.3±0.2 | 7.3±0.2 | 3.4 ⁺⁰ | 1.8 |
| SCDS74 | 7.3±0.2 | 7.3±0.2 | 4.5 ⁺⁰ | 1.8 |

Recommended Pattern

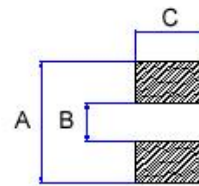

Dimension in mm

| TYPE | A | B | C |
|--------|-----|-----|-----|
| SCDS73 | 8.4 | 4.4 | 2.2 |
| SCDS74 | 8.4 | 4.4 | 2.2 |

SCDS 103R/ 104R/ 105R

Shape and Dimensions

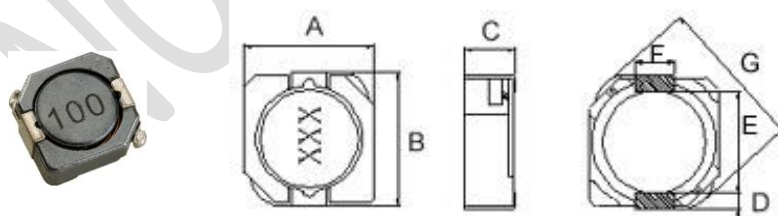

Dimensions in mm

| TYPE | A | B | C | D | E | F | G |
|----------|--------------------|--------------------|-------------------|-----|-----|-----|--------------------|
| SCDS103R | 10.3 ⁺⁰ | 10.5 ⁺⁰ | 3.1 ⁺⁰ | 1.2 | 7.7 | 3.0 | 13.5 ⁺⁰ |
| SCDS104R | 10.3 ⁺⁰ | 10.5 ⁺⁰ | 4 ⁺⁰ | 1.2 | 7.7 | 3.0 | 13.5 ⁺⁰ |
| SCDS105R | 10.3 ⁺⁰ | 10.5 ⁺⁰ | 5.1 ⁺⁰ | 1.2 | 7.7 | 3.0 | 13.5 ⁺⁰ |

Recommended Pattern

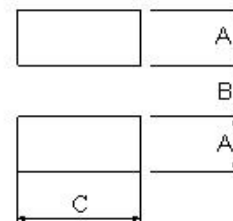

Dimension in mm

| TYPE | A | B | C |
|----------|-----|-----|-----|
| SCDS103R | 1.6 | 7.3 | 3.2 |
| SCDS104R | 1.6 | 7.3 | 3.2 |
| SCDS105R | 1.6 | 7.3 | 3.2 |

SMD Shielded Power Inductors - SCDS Series

SCDS 124/125/127

Shape and Dimensions

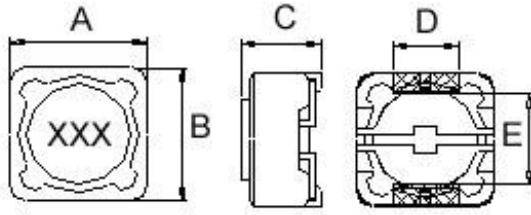

Recommended Pattern

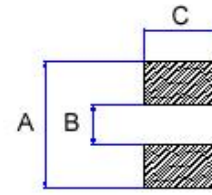

Dimensions in mm

| TYPE | A | B | C | D | E |
|---------|--------------------|--------------------|-------------------|---|-----|
| SCDS124 | 12.5 ⁺⁰ | 12.5 ⁺⁰ | 4.5 ⁺⁰ | 5 | 7.6 |
| SCDS125 | 12.5 ⁺⁰ | 12.5 ⁺⁰ | 6 ⁺⁰ | 5 | 7.6 |
| SCDS127 | 12.5 ⁺⁰ | 12.5 ⁺⁰ | 8 ⁺⁰ | 5 | 7.6 |

Dimensions in mm

| TYPE | A | B | C |
|---------|----|---|-----|
| SCDS124 | 13 | 7 | 5.4 |
| SCDS125 | 13 | 7 | 5.4 |
| SCDS127 | 13 | 7 | 5.4 |

NOT FOR NEW DESIGN

SMD Shielded Power Inductors - SCDS Series

Standard Specifications

| Stamp | Inductance (μH) | RDC (mΩ) Max | | | | | | | |
|-------|-----------------|--------------|---------|-----------|-----------|-----------|----------|----------|----------|
| | | SCDS 73 | SCDS 74 | SCDS 103R | SCDS 104R | SCDS 105R | SCDS 124 | SCDS 125 | SCDS 127 |
| R80 | 0.8 | | | | | 4.3 | | | |
| 1R0 | 1.0 | | | | 7.5 | | | | |
| 1R2 | 1.2 | | | | | | | | 7.0 |
| 1R5 | 1.5 | 30 | 20 | | 8.1 | 5.8 | | | 8.0 |
| 1R8 | 1.8 | | 25 | | 9.5 | | | | |
| 2R2 | 2.2 | 30 | 25 | | 10.5 | 11 | | | 11.5 |
| 2R4 | 2.4 | | | | | | | | 11.5 |
| 2R5 | 2.5 | | | | 10.5 | | | | |
| 2R7 | 2.7 | | 30 | | | | | | |
| 3R3 | 3.3 | 40 | 35 | | 13 | 10.4 | 15 | 15 | 13.5 |
| 3R5 | 3.5 | | | | | | | | 13.5 |
| 3R8 | 3.8 | | | | 13 | | | | |
| 3R9 | 3.9 | | | | | | 15 | | |
| 4R7 | 4.7 | | 35 | 30 | 18 | 12.3 | 18 | 18 | 15.8 |
| 5R2 | 5.2 | | | | 22 | | | | |
| 5R6 | 5.6 | | | | 27 | | | | |
| 6R1 | 6.1 | | | | | | | | 17.6 |
| 6R4 | 6.4 | | | | | | | 18 | |
| 6R8 | 6.8 | 60 | 45 | 35 | 27 | 18 | 23 | | 20.0 |
| 7R0 | 7.0 | | | | 27 | | | | |
| 7R6 | 7.6 | | | | | | | | 20.0 |
| 8R2 | 8.2 | | | | 33 | 20 | | 25 | |
| 100 | 10 | 72 | 49 | 59 | 35 | 26 | 28 | 25 | 21.6 |
| 120 | 12 | 98 | 58 | | | 33 | 38 | 27 | 24.3 |
| 150 | 15 | 130 | 81 | 91 | 50 | 41 | 50 | 30 | 27.0 |
| 180 | 18 | 140 | 91 | | 70 | 46 | 57 | 34 | 39.2 |
| 220 | 22 | 190 | 110 | | 73 | 61 | 66 | 36 | 43.2 |
| 270 | 27 | 210 | 150 | | 90 | 69 | 80 | 51 | 45.9 |
| 330 | 33 | 240 | 170 | 202 | 93 | 84 | 97 | 57 | 64.8 |
| 390 | 39 | 320 | 230 | | 128 | 106 | 132 | 68 | 72.9 |
| 470 | 47 | 360 | 260 | 299 | 128 | 130 | 150 | 75 | 100 |
| 560 | 56 | 470 | 350 | | 213 | 149 | 190 | 110 | 110 |
| 680 | 68 | 520 | 380 | | 213 | 201 | 220 | 120 | 140 |
| 820 | 82 | 690 | 430 | | 280 | 227 | 260 | 140 | 160 |
| 101 | 100 | 790 | 610 | | 304 | 253 | 308 | 160 | 220 |
| 121 | 120 | 890 | 660 | | | 303 | 380 | 170 | 250 |
| 151 | 150 | 1270 | 880 | | 506 | 370 | 530 | 230 | 280 |
| 181 | 180 | 1450 | 980 | | | 419 | 620 | 290 | 350 |
| 201 | 200 | | | | 756 | | | | |
| 221 | 220 | 1650 | 1170 | | 756 | 500 | 700 | 400 | 390 |
| 271 | 270 | 2310 | 1640 | | | 672 | 876 | 460 | 560 |
| 331 | 330 | 2620 | 1860 | | 1090 | 812 | 990 | 510 | 640 |
| 391 | 390 | 2940 | 2850 | | | 953 | | 690 | 700 |
| 471 | 470 | 4180 | 3010 | | 1600 | 1289 | | 770 | 980 |
| 561 | 560 | 4670 | 3620 | | 2100 | 1430 | | 860 | 1070 |
| 681 | 680 | 5730 | 4630 | | | 1599 | | 1200 | 1460 |
| 821 | 820 | 6540 | 5200 | | | 1768 | | 1340 | 1640 |
| 102 | 1000 | 9440 | 6000 | | | 1989 | | 1530 | 1820 |

Note: When ordering, please specify tolerance code. Tolerance: M=±20%, T=±30%, N = ⁺⁴⁰/₋₂₀%

- Operating temperature range - 40°C ~ 105°C(Including self - temperature rise)
- Isat for Inductance drop 35% from its value without current
- Measure Equipment :
 L : Agilent/ E4980 or HP4284A (under 1MHz), HP4285A (over 1MHz)
 RDC : Chroma 16502
 Rated Current : HP4284+42841A or WK3260B+WK3265B

Please be sure to request approval specifications that provide further details of the products. Kindly note that the content of these specifications are subject to change or may be discontinued without prior notice. This product may not be designed/used in medical or high risk applications without Chilisin approval. Please contact our sales department before ordering.



CHILISIN ELECTRONICS CORP.

SMD Shielded Power Inductors - SCDS Series

Standard Specifications

| Stamp | Inductance (μH) | Isat (A) | | | | | | | |
|-------|-----------------|----------|---------|-----------|-----------|-----------|----------|----------|----------|
| | | SCDS 73 | SCDS 74 | SCDS 103R | SCDS 104R | SCDS 105R | SCDS 124 | SCDS 125 | SCDS 127 |
| R80 | 0.8 | | | | | 13.5 | | | |
| 1R0 | 1.0 | | | | 11 | | | | |
| 1R2 | 1.2 | | | | | | | | 9.80 |
| 1R5 | 1.5 | 4.00 | 5.00 | | 10. | 10.5 | | | 9.50 |
| 1R8 | 1.8 | | 4.00 | | 8.5 | | | | |
| 2R2 | 2.2 | 4.00 | 3.50 | | 7.5 | 9.25 | | | 8.00 |
| 2R4 | 2.4 | | | | | | | | 8.00 |
| 2R5 | 2.5 | | | | 7.5 | | | | |
| 2R7 | 2.7 | | 3.50 | | | | | | |
| 3R3 | 3.3 | 3.70 | 3.50 | | 6.0 | 7.8 | 6.50 | 8.00 | 7.50 |
| 3R5 | 3.5 | | | | | | | | 7.50 |
| 3R8 | 3.8 | | | | 6.0 | | | | |
| 3R9 | 3.9 | | | | | | 6.50 | | |
| 4R7 | 4.7 | | 3.00 | 4.65 | 5.7 | 6.40 | 5.70 | 7.60 | 6.80 |
| 5R2 | 5.2 | | | | 5.5 | | | | |
| 5R6 | 5.6 | | | | 5.0 | | | | |
| 6R1 | 6.1 | | | | | | | | 6.60 |
| 6R4 | 6.4 | | | | | | | 5.8 | |
| 6R8 | 6.8 | 2.00 | 2.50 | 3.84 | 5.0 | 5.40 | 4.90 | | 6.20 |
| 7R0 | 7.0 | | | | 4.8 | | | | |
| 7R6 | 7.6 | | | | | | | | 5.90 |
| 8R2 | 8.2 | | | | 4.5 | 4.85 | | 5.00 | |
| 100 | 10 | 1.68 | 1.84 | 3.18 | 4.4 | 4.45 | 4.50 | 4.00 | 5.40 |
| 120 | 12 | 1.52 | 1.71 | | | 4.00 | 4.00 | 3.50 | 4.90 |
| 150 | 15 | 1.33 | 1.47 | 2.60 | 3.6 | 3.60 | 3.20 | 3.30 | 4.50 |
| 180 | 18 | 1.20 | 1.31 | | 3.5 | 3.20 | 3.10 | 3.00 | 3.90 |
| 220 | 22 | 1.07 | 1.23 | | 2.9 | 2.95 | 2.90 | 2.80 | 3.60 |
| 270 | 27 | 0.96 | 1.12 | | 2.5 | 2.70 | 2.80 | 2.30 | 3.40 |
| 330 | 33 | 0.91 | 0.96 | 1.74 | 2.3 | 2.50 | 2.70 | 2.10 | 3.00 |
| 390 | 39 | 0.77 | 0.91 | | 2.1 | 2.30 | 2.10 | 2.00 | 2.75 |
| 470 | 47 | 0.76 | 0.88 | 1.43 | 2.1 | 2.00 | 1.90 | 1.80 | 2.50 |
| 560 | 56 | 0.68 | 0.75 | | 1.6 | 1.90 | 1.80 | 1.70 | 2.35 |
| 680 | 68 | 0.61 | 0.69 | | 1.5 | 1.65 | 1.50 | 1.50 | 2.10 |
| 820 | 82 | 0.57 | 0.61 | | 1.35 | 1.50 | 1.30 | 1.40 | 1.95 |
| 101 | 100 | 0.50 | 0.60 | | 1.35 | 1.35 | 1.20 | 1.30 | 1.70 |
| 121 | 120 | 0.49 | 0.52 | | | 1.28 | 1.10 | 1.10 | 1.60 |
| 151 | 150 | 0.43 | 0.46 | | 1.15 | 1.12 | 0.95 | 1.00 | 1.42 |
| 181 | 180 | 0.39 | 0.42 | | | 1.04 | 0.85 | 0.90 | 1.30 |
| 201 | 200 | | | | 0.92 | | | | |
| 221 | 220 | 0.35 | 0.36 | | 0.92 | 0.94 | 0.80 | 0.80 | 1.16 |
| 271 | 270 | 0.32 | 0.34 | | | 0.84 | 0.60 | 0.75 | 1.06 |
| 331 | 330 | 0.28 | 0.32 | | 0.70 | 0.75 | 0.50 | 0.68 | 0.95 |
| 391 | 390 | 0.26 | 0.29 | | | 0.70 | | 0.65 | 0.88 |
| 471 | 470 | 0.24 | 0.26 | | 0.50 | 0.60 | | 0.58 | 0.79 |
| 561 | 560 | 0.22 | 0.23 | | 0.40 | 0.54 | | 0.54 | 0.73 |
| 681 | 680 | 0.19 | 0.22 | | | 0.52 | | 0.48 | 0.67 |
| 821 | 820 | 0.18 | 0.20 | | | 0.50 | | 0.43 | 0.60 |
| 102 | 1000 | 0.16 | 0.18 | | | 0.48 | | 0.40 | 0.55 |

Tolerance Of Inductors

- SCDS 73 1.5 ~ 1000uH ± 20%
- SCDS 74 1.5 ~ 1000uH ± 20%
- SCDS 103R 4.7~47uH ± 30%
- SCDS 104R 1.0 ~ 470uH ± 30%
- SCDS 105R 0.8 ~ 1000uH ± 30%
- Tolerance : M = ±20% , T = ±30% , N = ⁺⁴⁰/₋₂₀%
- SCDS 124 3.3 ~ 330uH ±20%
- SCDS 125 3.3 ~ 1000uH ± 20%
- SCDS 127 1.2 ~ 7.6uH ⁺⁴⁰/₋₂₀%
- SCDS 127 10 ~ 1000uH ± 20%

Please be sure to request approval specifications that provide further details of the products. Kindly note that the content of these specifications are subject to change or may be discontinued without prior notice. This product may not be designed/used in medical or high risk applications without Chilisin approval. Please contact our sales department before ordering.



CHILISIN ELECTRONICS CORP.

SMD Shielded Power Inductors - SCDS Series

Curves of SCDS Series

Test Instruments : HP4294 Impedance / Material Analyzer

SCDS73

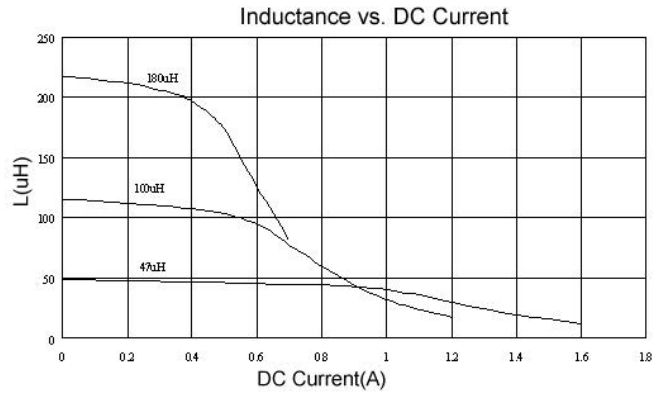
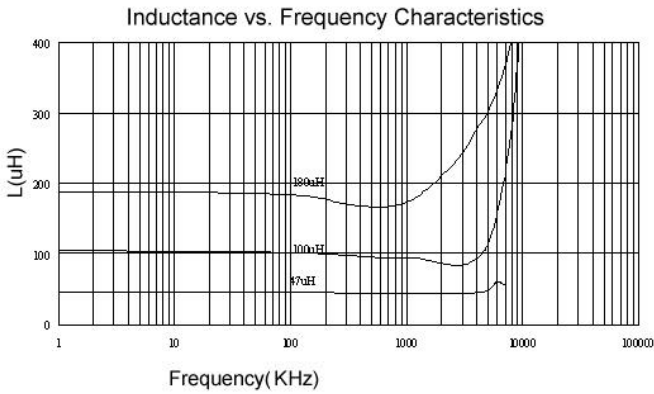

SCDS74

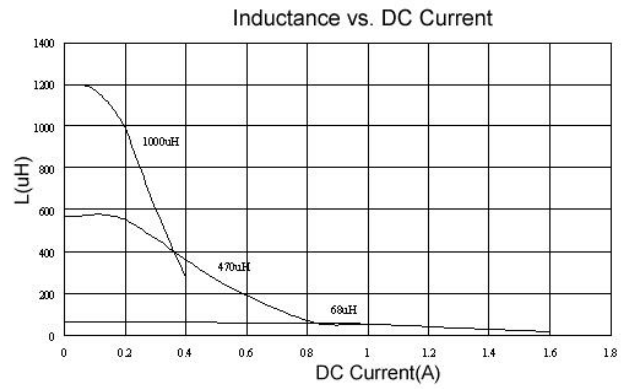
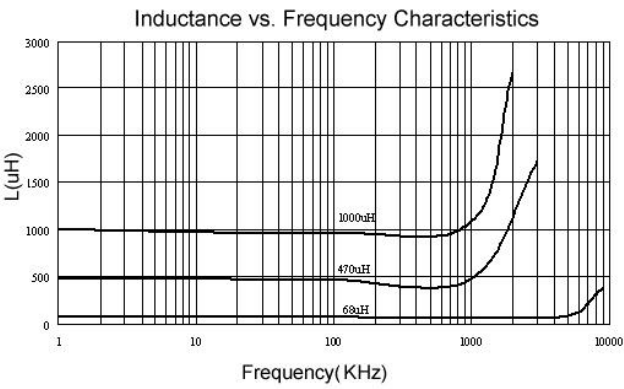

Test Instruments : HP4294 Impedance / Material Analyzer

SCDS104R

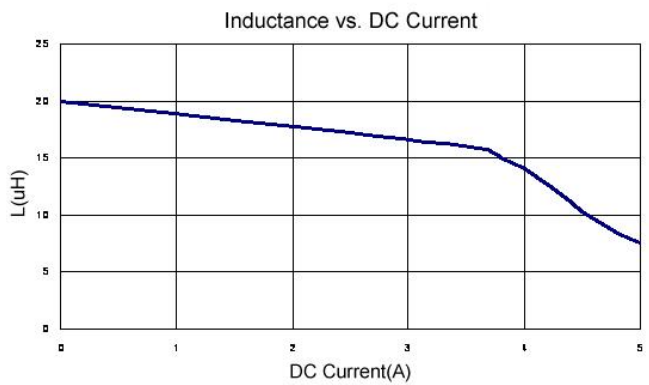
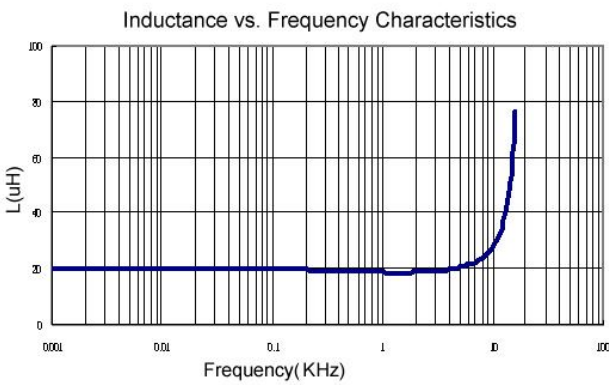

SCDS124

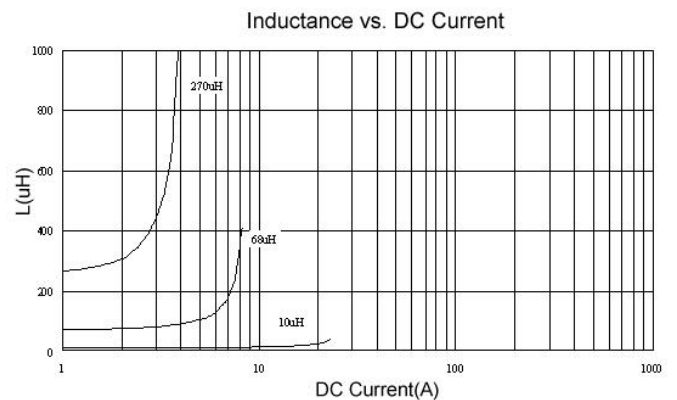
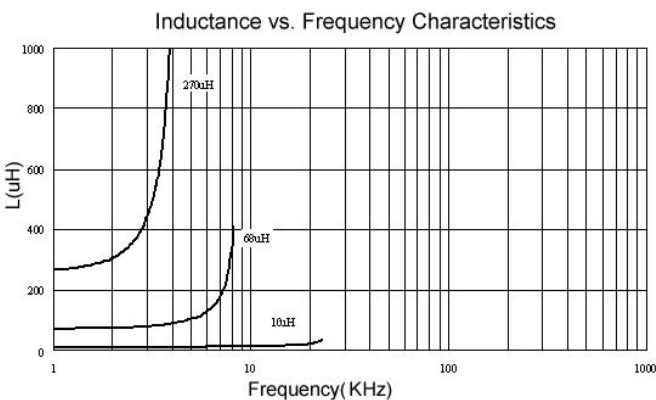

Please be sure to request approval specifications that provide further details of the products. Kindly note that the content of these specifications are subject to change or may be discontinued without prior notice. This product may not be designed/used in medical or high risk applications without Chilisin approval. Please contact our sales department before ordering.

SMD Shielded Power Inductors - SCDS Series

SCDS125

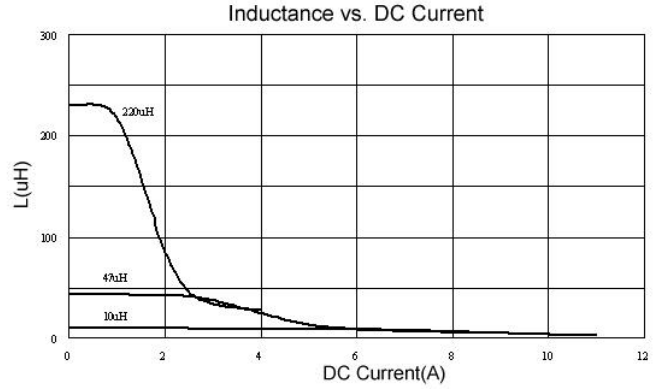
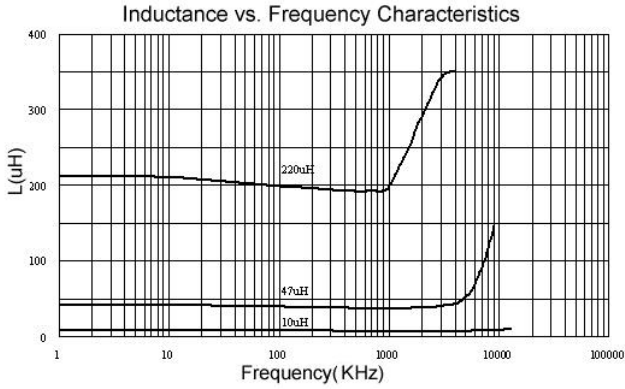

SCDS127

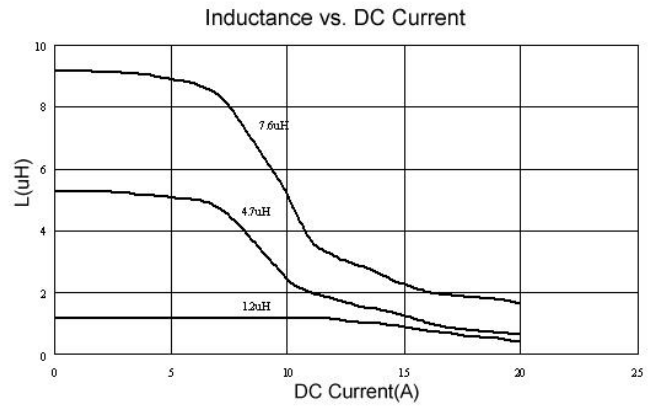
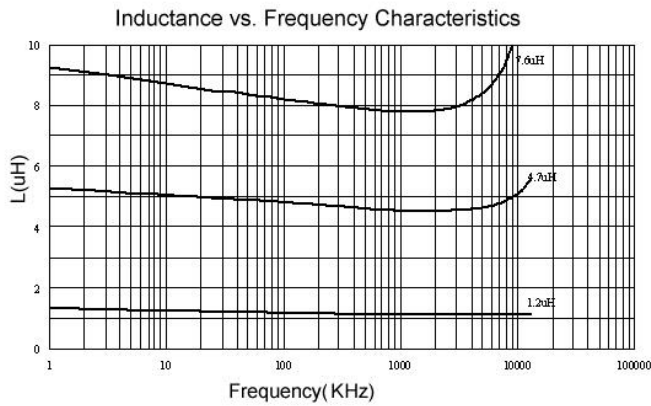

SMD Shielded Power Inductors - SCDS Series

Packaging Specifications

Tape Dimensions

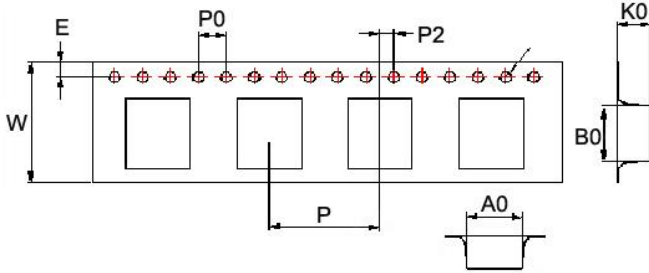

Tape Material

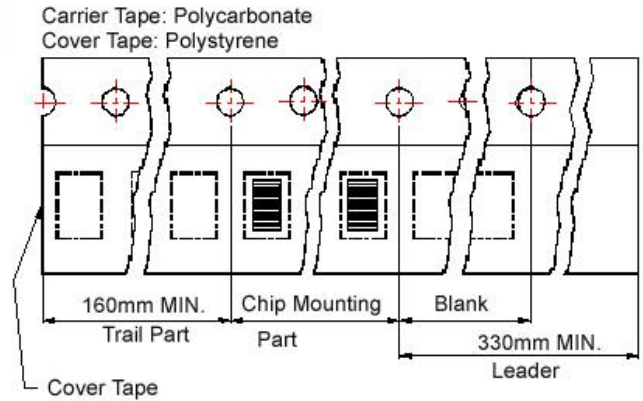

Reel Dimensions

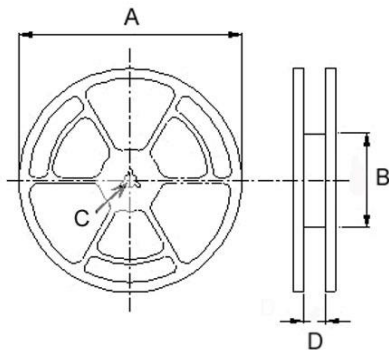

Dimensions in mm

| TYPE | Tape Dimensions | | | | | | | | | Reel Dimensions | | | | Quantity PCS / REEL |
|-----------|-----------------|-------|-----|------|------|----|----|----|----|-----------------|-----|----|------|------------------------|
| | A0 | B0 | K0 | D | E | W | P | P0 | P2 | A | B | C | D | |
| SCDS 73 | 7.6 | 7.6 | 3.6 | 1.55 | 1.75 | 16 | 12 | 4 | 2 | 330 | 100 | 13 | 16.0 | 1600 |
| SCDS 74 | 7.6 | 7.6 | 5.0 | 1.55 | 1.75 | 16 | 12 | 4 | 2 | 330 | 100 | 13 | 16.0 | 1000 |
| SCDS 103R | 10.6 | 10.75 | 4.2 | 1.55 | 1.75 | 24 | 16 | 4 | 2 | 300 | 100 | 13 | 24.4 | 1000 |
| SCDS 104R | 10.6 | 10.75 | 4.2 | 1.5 | 1.75 | 24 | 16 | 4 | 2 | 330 | 100 | 13 | 24.4 | 1000 |
| SCDS 105R | 10.6 | 10.6 | 5.0 | 1.5 | 1.75 | 24 | 16 | 4 | 2 | 330 | 100 | 13 | 24.4 | 500 |
| SCDS 124 | 13.0 | 12.8 | 5.1 | 1.55 | 1.75 | 24 | 16 | 4 | 2 | 330 | 100 | 13 | 24.4 | 500 |
| SCDS 125 | 12.6 | 12.6 | 6.7 | 1.55 | 1.75 | 24 | 16 | 4 | 2 | 330 | 100 | 13 | 24.4 | 600 |
| SCDS 127 | 12.6 | 12.6 | 8.7 | 1.55 | 1.75 | 24 | 16 | 4 | 2 | 330 | 100 | 13 | 24.4 | 500 |

X-ON Electronics

Largest Supplier of Electrical and Electronic Components

Click to view similar products for [Fixed Inductors](#) category:

Click to view products by [Chilisin](#) manufacturer:

Other Similar products are found below :

[CR43NP-680KC](#) [CR54NP-470LC](#) [CR54NP-820KC](#) [CR54NP-8R5MC](#) [70F224AI](#) [MGDQ4-00004-P](#) [MHL1ECTTP18NJ](#) [MHQ1005P10NJ](#)
[MHQ1005P1N0S](#) [MHQ1005P2N4S](#) [MHQ1005P3N6S](#) [MHQ1005P5N1S](#) [MHQ1005P8N2J](#) [PE-51506NL](#) [PE-53601NL](#) [PE-53602NL](#) [PE-53630NL](#) [PE-53824SNLT](#) [PE-92100NL](#) [PG0434.801NLT](#) [PG0936.113NLT](#) [9220-20](#) [9310-16](#) [PM06-2N7](#) [PM06-39NJ](#) [A01TK](#) [1206CS-471XJ](#) [HC2LP-R47-R](#) [HC2-R47-R](#) [HC3-2R2-R](#) [HC3-R50-R](#) [HC8-1R2-R](#) [HCF1305-3R3-R](#) [1206CS-151XG](#) [RCH664NP-140L](#) [RCH664NP-4R7M](#) [RCH8011NP-221L](#) [RCP1317NP-332L](#) [RCP1317NP-391L](#) [RCR1010NP-470M](#) [RCR110DNP-331L](#) [DH2280-4R7M](#) [DS1608C-106](#)
[ASPI-4020HI-R10M-T](#) [B10TJ](#) [B82498B3101J000](#) [ELJ-RE27NJF2](#) [1812CS-153XJ](#) [1812CS-183XJ](#) [1812CS-223XJ](#)