



四川华瓷科技有限公司

承认书

APPROVAL SHEET

产品名称：多层片式陶瓷电容器

PART NAME：MULTILAYER CERAMIC CAPACITORS

系列：通用系列 (4V~63V)

SERIES：General Purpose Series (4V~63V)

规格：0201 ~ 1210 尺寸

SPECIFICATION：0201 ~ 1210 Size

供应商 (SUPPLIER)：四川华瓷科技有限公司

发布日期 (ISSUE DATE)：20200701

批准 (APPROVED BY)：_____

客户许可 (CUSTOMER APPROVAL)：



1、概述 (GENERAL INFO)

适合厂家高密度、高效表面贴装的陶瓷电容器。

For high density and high efficiency SMT application.

产品采用 NP0 (C0G、C0H) , X7R 、 X5R、 X7S 和 X6S 材质制作 , 具有电气性能优越、可靠性高的特点。

We can provide NP0(C0G/C0H)/X7R/X5R/X7S/X6S capacitors with high reliability and excellent electrical performance.

2、产品特点 (FEATURES):

a、可选尺寸范围广 , 0201 至 1210 规格。More selection of size,0201 to 1210 all being available .

b、给定尺寸容量高。High capacity and small size can be achieved.

3、应用领域 (APPLICATIONS):

a、一般数字电路。For general digital circuit.

b、电源旁路。For power supply bypass capacitors.

c、消费电子。For consumer electronics.

d、通讯行业。For telecommunication

4、型号规格表示方法： HOW TO ORDER

HGC	0805	R7	104	K	500	N	T	H	J
Series 产品系列	Size inch(mm) 尺寸	Dielectric 材质	Capacitance 电容量	Tolerance 精度级别	RatedVoltage 额定电压	Termination 端电极类型	Packaging 包装方式	Thickness (mm) 厚度代码	Reel Size 卷盘尺寸
HGC 通用型	1005(0402) 0201(0603) 0402(1005) 0603(1608) 0805(2012) 1206(3216) 1210(3225)	R5=X5R S6=X6S R7=X7R S7=X7S T7=X7T G0=C0G H0=C0H	R75=0.75pF 0R5=0.5pF 1R0=1pF 100=10pF 101=100pF 102=1000pF 103=10nF 104=100nF 105=1μF 106=10μF 107=100μF	A=±0.05pF B=±0.1pF C=±0.25pF D=±0.5pF F=±1% G=±2% J=±5% K=±10% L=±15% M=±20% S=-20%~+50%	4R0=4 Vdc 6R3=6.3 Vdc 100=10 Vdc 160=16 Vdc 250=25 Vdc 500=50 Vdc 101=100 Vdc 201=200 Vdc 251=250 Vdc 501=500 Vdc 631=630 Vdc 102=1k Vdc 152=1.5k Vdc 202=2k Vdc 252=2.5k Vdc 302=3k Vdc 402=4k Vdc 502=5k Vdc 602=6k Vdc	N=Cu/Ni/Sn C=Cu/Resin/ Ni/Sn	T=纸带 Paper taping B=散包装 Bulk S=塑胶带 Embossed taping	A=0.1mm B=0.2mm C=0.3mm D=0.4mm E=0.5mm F=0.6mm G=0.7mm H=0.8mm J=1.0mm L=1.25mm P=1.6mm S=1.8mm U=2.0mm V=2.5mm W=3.0mm	J=7Inch D=13Inch K=7Inch 12mm width tape



5、温度系数/特性 Temperature Coefficient /Characteristics

介质种类 Dielectric	参考温度点 Reference Temperature Point	标称温度系数 Temperature Coefficient	工作温度范围 Operation Temperature Range
C0G	20°C	0±30 ppm/°C	-55°C ~ 125°C
C0H	20°C	0±60 ppm/°C	-55°C ~ 125°C
X7R	20°C	±15%	-55°C ~ 125°C
X5R	20°C	±15%	-55°C ~ 85°C
X7S	20°C	±22%	-55°C ~ 125°C
X6S	20°C	±22%	-55°C ~ 105°C

备注：I 类电容器标称温度系数和允许偏差是采用温度在 20°C 和 85°C 之间的电容量变化来确定的，而 II 类电容器标称温度系数是按照工作范围之间的电容量相对 20°C 的电容量变化来确定的。

Note：Nominal temperature coefficient and allowed tolerance of class I are decided by the changing of the capacitance between 20°C and 85°C. Nominal temperature coefficient of class II are decided by the temperature of 20°C.

6、产品外围尺寸及内部结构 EXTERNAL DIMENSIONS AND STRUCTURE

6-1 产品外围尺寸 Product peripheral dimension

外观 Outline	尺寸 Size	长度 L	宽度 W (mm)	厚度 T (mm)/厚度代码		焊接方式 Soldering Method	端头宽度 MB(mm)
	Inch (mm)	(mm)		Symbol			
	0201 (0603)	0.60±0.03	0.30±0.03	0.30±0.03	C	R	0.15±0.05
	0402 (1005)	1.00±0.05	0.50±0.05	0.50±0.05	E(C < 105)	R	0.25±0.10
		1.00±0.20	0.50±0.20	0.50±0.20	E(C ≥ 105)	R	
	0603 (1608)	1.60±0.20	0.80±0.20	0.80±0.20	H	R / W	0.40±0.15
	0805 (2012)	2.00±0.20	1.25±0.20	0.70±0.10	G	R / W	0.50±0.20
				0.80±0.20	H		
				1.25±0.20	L	R	
	1206 (3216)	3.20±0.20	1.60±0.20	0.70±0.10	G	R / W	0.60±0.20
				0.80±0.20	H		
				1.00±0.10	J	R	
				1.25±0.20	L		
	1210 (3225)	3.20±0.30	2.50±0.30	1.60±0.20	P	R	0.75±0.25
2.00±0.20				U			
2.50±0.30				V			
1.25±0.20				L			

说明：R=Reflow Soldering 回流焊

W=Wave Soldering 波峰焊



6-2 结构 STRUCTURE



7、包装标准数量 PACKAGING STANDARD QUANTITY

Size 尺寸	Thickness (mm)/Symbol 厚度/符号		Paper tape 纸带	Plastic Tape 胶带
			7"reel	7"reel
0201 (0603)	0.30±0.03	C	15,000	-----
0402 (1005)	0.50±0.05	E(C < 105)	10,000	-----
	0.50±0.20	E(C ≥ 105)	10,000	-----
0603 (1608)	0.80±0.20	H	4000	-----
0805 (2012)	0.70±0.10	G	4000	-----
	0.80±0.20	H	4000	-----
	1.25±0.20	L	-----	3000
1206 (3216)	0.70±0.10	G	4000	-----
	0.80±0.20	H	4000	-----
	1.00±0.10	J	-----	3000
	1.25±0.20	L	-----	3000
	1.60±0.20	P	-----	2000
1210 (3225)	1.25±0.20	L	-----	2000
	1.60±0.20	P	-----	2000
	2.00±0.20	U	-----	2000
	2.50±0.30	V	-----	1000



四川华瓷科技有限公司

8、容量范围及其电压 Capacitance Range and rating Voltage

8-1 C0G、C0H Dielectric

Dielectric		C0G、C0H								
(尺寸)Size		0201	0402	0603	0805		1206		1210	
额定电压 Rated Voltage (VDC)		16 25 50	25 50	25 50	10 16	25 50	10 16	25 50	10 16	25 50
Capacitance	0.3pF (0R3)	C	E	H						
	0.4pF (0R4)	C	E	H						
	0.5pF (0R5)	C	E	H	G	G				
	0.6pF (0R6)	C	E	H	G	G				
	0.7pF (0R7)	C	E	H	G	G				
	0.8pF (0R8)	C	E	H	G	G				
	0.9pF (0R9)	C	E	H	G	G				
	1.0pF (1R0)	C	E	H	G	G				
	1.2pF (1R2)	C	E	H	G	G	G	G		
	1.5pF (1R5)	C	E	H	G	G	G	G		
	1.8pF (1R8)	C	E	H	G	G	G	G		
	2.0pF (2R0)	C	E	H	G	G	G	G		
	2.2pF (2R2)	C	E	H	G	G	G	G		
	2.7pF (2R7)	C	E	H	G	G	G	G		
	3.0pF (3R0)	C	E	H	G	G	G	G		
	3.3pF (3R3)	C	E	H	G	G	G	G		
	3.9pF (3R9)	C	E	H	G	G	G	G		
	4.0pF (4R0)	C	E	H	G	G	G	G		
	4.7pF (4R7)	C	E	H	G	G	G	G		
	5.0pF (5R0)	C	E	H	G	G	G	G		
	5.6pF (5R6)	C	E	H	G	G	G	G		
	6.0pF (6R0)	C	E	H	G	G	G	G		
	6.8pF (6R8)	C	E	H	G	G	G	G		
	7.0pF (7R0)	C	E	H	G	G	G	G		
	8.0pF (8R0)	C	E	H	G	G	G	G		
	8.2pF (8R2)	C	E	H	G	G	G	G		
	9.0pF (9R0)	C	E	H	G	G	G	G		
	10pF (100)	C	E	H	G	G	G	G		L L
	12pF (120)	C	E	H	G	G	G	G	L L	L L
	15pF (150)	C	E	H	G	G	G	G	L L	L L
	18pF (180)	C	E	H	G	G	G	G	L L	L L
	22pF (220)	C	E	H	G	G	G	G	L L	L L
	27pF (270)	C	E	H	G	G	G	G	L L	L L
	33pF (330)	C	E	H	G	G	G	G	L L	L L
	39pF (390)	C	E	H	G	G	G	G	L L	L L
	47pF (470)	C	E	H	G	G	G	G	L L	L L
	56pF (560)	C	E	H	G	G	G	G	L L	L L
	68pF (680)	C	E	H	G	G	G	G	L L	L L
	82pF (820)	C	E	H	G	G	G	G	L L	L L
	100pF (101)	C	E	H	G	G	G	G	L L	L L
	120pF (121)		E	H	G	G	G	G	L L	L L
	150pF (151)		E	H	G	G	G	G	L L	L L
	180pF (181)		E	H	G	G	G	G	L L	L L
	220pF (221)		E	H	G	G	G	G	L L	L L
	270pF (271)		E	H	G	G	G	G	L L	L L
	330pF (331)		E	H	G	G	G	G	L L	L L
	390pF (391)		E	H	G	G	G	G	L L	L L
	470pF (471)		E	H	G	G	G	G	L L	L L
	560pF (561)		E	H	G	G	G	G	L L	L L
	680pF (681)		E	H	G	G	G	G	L L	L L
820pF (821)		E	H	G	G	H	H	L L	L L	
1,000pF (102)		E	H	G	G	H	H	L L	L L	
1,200pF (122)			H	G	G	H	H	L L	L L	
1,500pF (152)			H	G	G	H	H	L L	L L	
1,800pF (182)			H	G	G	H	H	L L	L L	
2,200pF (222)			H	G	G	H	H	L L	L L	
2,700pF (272)				H	H	H	H	L L	L L	
3,300pF (332)				H	H	H	H	L L	L L	
3,900pF (392)				H	H	H	H	L L	L L	
4,700pF (472)				H	H	H	H	L L	L L	
5,600pF (562)				H	H	L	L	L L	L L	
6,800pF (682)				H	H	L	L	L L	L L	
8,200pF (822)				H	H	L	L	L L	L L	
0.010μF (103)					L	L	P	P	L L	L L
0.012μF (123)							P	P	L L	L L
0.015μF (153)							P	P	L L	L L
0.018μF (183)							P	P	U U	U U
0.022μF (223)							P	P	U U	U U
0.027μF (273)							P	P	U U	U U
0.033μF (333)							P	P	U U	U U
0.039μF (393)							P	P	U U	U U
0.047μF (473)							P	P	U U	U U
0.056μF (563)							P	P	U U	U U
0.068μF (683)							P	P	U U	U U
0.082μF (823)							P	P	U U	U U
0.10μF (104)							P	P	U U	U U



四川华瓷科技有限公司

8-2 X7R Dielectric

Dielectric	X7R																		
	0201			0402			0603			0805			1206			1210			
Size	6.3 10	16 25	50	6.3 10	16 25	50	6.3 10 16	25	50	6.3 10 16	25	50	6.3 10 16	25	50	10	16	25	50
Rated Voltage (VDC)	6.3 10	16 25	50	6.3 10	16 25	50	6.3 10 16	25	50	6.3 10 16	25	50	6.3 10 16	25	50	10	16	25	50
100pF(101)	C	C	C		E	E		H	H		H	H							
120pF(121)	C	C	C		E	E		H	H		H	H							
150pF(151)	C	C	C		E	E		H	H		H	H		H	H				
180pF(181)	C	C	C		E	E		H	H		H	H		H	H				
220pF(221)	C	C	C		E	E		H	H		H	H		H	H				
270pF(271)	C	C	C		E	E		H	H		H	H		H	H				
330pF(331)	C	C	C		E	E		H	H		H	H		H	H				
390pF(391)	C	C	C		E	E		H	H		H	H		H	H				
470pF(471)	C	C	C		E	E		H	H		H	H		H	H				
560pF(561)	C	C	C		E	E		H	H		H	H		H	H				
680pF(681)	C	C	C		E	E		H	H		H	H		H	H				
820pF(821)	C	C	C		E	E		H	H		H	H		H	H				
1,000pF(102)	C	C	C		E	E		H	H		H	H		H	H				
1,200pF(122)	C	C		E	E	E		H	H	H	H	H	H	H	H				
1,500pF(152)	C	C		E	E	E		H	H	H	H	H	H	H	H				
1,800pF(182)	C	C		E	E	E		H	H	H	H	H	H	H	H				
2,200pF(222)	C	C		E	E	E		H	H	H	H	H	H	H	H				
2,700pF(272)	C	C		E	E	E		H	H	H	H	H	H	H	H				
3,300pF(332)	C	C		E	E	E		H	H	H	H	H	H	H	H				
3,900pF(392)	C	C		E	E	E		H	H	H	H	H	H	H	H				
4,700pF(472)	C	C		E	E	E		H	H	H	H	H	H	H	H				
5,600pF(562)	C	C		E	E	E		H	H	H	H	H	H	H	H				
6,800pF(682)	C	C		E	E	E		H	H	H	H	H	H	H	H				
8,200pF(822)	C	C		E	E	E		H	H	H	H	H	H	H	H				
0.010μF(103)	C	C		E	E	E	H	H	H	H	H	H	H	H	H				
0.012μF(123)				E	E	E	H	H	H	H	H	H	H	H	H				
0.015μF(153)				E	E	E	H	H	H	H	H	H	H	H	H				
0.018μF(183)				E	E	E	H	H	H	H	H	H	H	H	H				
0.022μF(223)				E	E	E	H	H	H	H	H	H	H	H	H				
0.027μF(273)				E	E		H	H	H	H	H	H	H	H	H				
0.033μF(333)				E	E		H	H	H	H	H	H	H	H	H				
0.039μF(393)				E	E		H	H	H	H	H	H	H	H	H				
0.047μF(473)				E	E		H	H	H	H	H	H	H	H	H				
0.056μF(563)				E	E		H	H	H	H	H	H	H	H	H				
0.068μF(683)				E	E		H	H	H	H	H	H	H	H	H				
0.082μF(823)				E	E		H	H	H	H	H	H	H	H	H	J	J	J	J
0.10μF(104)				E	E		H	H	H	H	H	H	H	H	H	J	J	J	J
0.12μF(124)							H	H	H	H	H	H	H	H	H	J	J	J	J
0.15μF(154)							H	H	H	H	H	H	H	J	J	J	J	J	J
0.18μF(184)							H	H	H	H	H	H	H	J	J	J	J	J	J
0.22μF(224)				E			H	H	H	H	H	H	H	J	J	J	J	J	J
0.27μF(274)							H	H	H	H	H	H	H	J	L	J	J	J	J
0.33μF(334)							H	H	H	H	H	H	H	J	L	J	J	J	L
0.39μF(394)							H	H	H	H	H	H	H	L	P	J	J	J	L
0.47μF(474)							H	H	H	L	L	L	H	L	P	J	J	J	L
0.56μF(564)							H	H	H	L	L	L	H	L	P	L	L	L	L
0.68μF(684)							H	H	H	L	L	L	H	L	P	L	L	L	L
0.82μF(824)							H	H	H	L	L	L	H	L	P	L	L	L	L
1.0μF(105)							H	H	H	L	L	L	L	L	P	L	L	L	L
1.5μF(155)										L	L		L	P			P	P	V
2.2μF(225)							H			L	L	L	L	P	P		P	P	V
3.3μF(335)										L	L		P	P			P	P	V
4.7μF(475)										L	L	L	P	P	P	U	U	U	V
6.8μF(685)										L			P						
10μF(106)										L			P	P		U	U	U	V
22μF(226)													P			V	V	V	
47μF(476)																V			

capacitance



四川华瓷科技有限公司

8-3 X7S Dielectric

Dielectric		X7S																						
Size		0402				0603				0805					1206					1210				
Rated Voltage (VDC)		6.3	10	16	25	6.3	10	16	25	10	16	25	50	100	6.3	10	16	25	50	6.3	10	16	25	50
Capacitance	1.0μF (105)		E						H					L										
	1.5μF (155)																							
	2.2μF (225)	E	E			H		H	H				L											
	3.3μF (335)																							
	4.7μF (475)					H	H	H					L		P	P	P	P	P					
	6.8μF (685)																							
	10μF (106)									L	L				P	P	P	P	P	U	U	U	U	U
	22μF (226)														P		P			V	V	V	V	
	47μF (476)														P						V	V		
100μF (107)																			V					

8-4 X5R Dielectric

Dielectric		X5R																																				
Size		0201					0402					0603					0805					1206					1210											
Rated Voltage (VDC)		6.3	10	16	25	50	6.3	10	16	25	50	6.3	10	16	25	50	6.3	10	16	25	50	6.3	10	16	25	50	6.3	10	16	25	50	4	6.3	10	16	25	50	
Capacitance	100pF(101)	C	C	C	C	C																																
	220pF(221)	C	C	C	C	C																																
	470pF(471)	C	C	C	C	C																																
	1,000pF(102)	C	C	C	C	C																																
	2,200pF(222)	C	C	C	C	C																																
	4,700pF(472)	C	C	C	C	C																																
	0.010μF(103)	C	C	C	C	C																																
	0.027μF(273)	C	C	C	C					E																												
	0.033μF(333)	C	C	C	C					E																												
	0.039μF(393)	C	C	C	C					E																												
	0.047μF(473)	C	C	C	C					E																												
	0.056μF(563)	C	C	C	C					E	E																											
	0.068μF(683)	C	C	C	C					E	E																											
	0.082μF(823)	C	C	C	C					E	E																											
	0.10μF(104)	C	C	C	C		E	E	E	E	E																											
	0.15μF(154)	C	C	C			E	E	E	E																												
	0.22μF(224)	C	C	C			E	E	E	E	E				H	H	H																					
	0.27μF(274)	C	C	C											H	H																						
	0.33μF(334)	C	C	C			E	E	E	E					H	H																						
	0.39μF(394)	C	C												H	H																						
	0.47μF(474)	C	C				E	E	E	E	E	H	H	H	H	H																						
	0.68μF(684)	C					E	E				H	H	H	H																							
	0.82μF(824)	C										H	H	H	H																							
	1.0μF(105)	C	C				E	E	E	E	E	H	H	H	H	H				L	L																	
	1.5μF(155)											H								L	L													U				
	2.2μF(225)	C					E	E	E	E		H	H	H	H	H	L	L	L	L	L				L	P	P				U							
	3.3μF(335)											H	H				L	L	L	L					P	P	P											
	4.7μF(475)						E	E	E			H	H	H	H		L	L	L	L	L	P	P	P	P	P				U	U	V						
	6.8μF(685)																					P	P															
	10μF(106)						E	E				H	H	H	H		L	L	L	L		P	P	P	P	P				U	U	U	V					
22μF(226)						E					H	H				L	L	L	L		P	P	P	P					V	V	V							
47μF(476)											H										P	P	P						V	V	V							
100μF(107)																L					P	P							V	V	V							
220μF(227)																					P								V	V								



四川华瓷科技有限公司

编号 No.	项目 Item	技术要求 Technical requirements		测试方法 Test Method and Remarks																			
4	I 类 Class I (C0G,C0H)	标称容量 Capacitance	损耗标准 DF Specification	测试温度 Test temperature : 25±3℃ 测试条件 Test condition : C≤1000pF : 1MHz±10%, 1.0±0.2Vrms C > 1000pF : 1KHz±10%,1.0±0.2Vrms																			
		Cr < 5 pF	≤0.56%																				
		5pF≤Cr < 50 pF	1.5[(150/Cr)+7]×10 ⁻⁴																				
		50pF≤Cr≤1000 pF	≤0.15%																				
		> 1000 pF	≤0.15%																				
	损耗角 正切 (DF, tanδ) Dissipation Factor	II类 Class II (X7R/X5R X7S/X6S)	<table border="1"> <thead> <tr> <th>项目 Item 额定电压 Rated vol.</th> <th>容量范围 C(μF)</th> <th>损耗标准 DF</th> </tr> </thead> <tbody> <tr> <td rowspan="2">≥50V</td> <td>C≥1.0</td> <td>≤5.0%</td> </tr> <tr> <td>C<1.0</td> <td>≤2.5%</td> </tr> <tr> <td rowspan="2">25V、16V</td> <td>C≥0.47</td> <td>≤10.0%</td> </tr> <tr> <td>C<0.47</td> <td>≤3.5%</td> </tr> <tr> <td rowspan="2">10V、63V</td> <td>C≥0.15</td> <td>≤10.0%</td> </tr> <tr> <td>C<0.15</td> <td>≤5.0%</td> </tr> </tbody> </table>		项目 Item 额定电压 Rated vol.	容量范围 C(μF)	损耗标准 DF	≥50V	C≥1.0	≤5.0%	C<1.0	≤2.5%	25V、16V	C≥0.47	≤10.0%	C<0.47	≤3.5%	10V、63V	C≥0.15	≤10.0%	C<0.15	≤5.0%	测试温度 Test temperature : 25±3℃ 测试条件 Test condition : C≤10μF : 1KHz±10%, 1.0±0.2Vrms C > 10μF : 120±24 Hz,0.5±0.1Vrms
			项目 Item 额定电压 Rated vol.	容量范围 C(μF)	损耗标准 DF																		
			≥50V	C≥1.0	≤5.0%																		
				C<1.0	≤2.5%																		
			25V、16V	C≥0.47	≤10.0%																		
C<0.47		≤3.5%																					
10V、63V		C≥0.15	≤10.0%																				
		C<0.15	≤5.0%																				
≥0402																							
<0402		<table border="1"> <thead> <tr> <th>项目 Item 额定电压 Rated vol.</th> <th>容量范围 C(μF)</th> <th>损耗标准 DF</th> </tr> </thead> <tbody> <tr> <td>≥50V</td> <td>所有容量</td> <td>≤3.5%</td> </tr> <tr> <td>25V</td> <td>所有容量</td> <td>≤5.0%</td> </tr> <tr> <td rowspan="2">16V</td> <td>C≥0.047</td> <td>≤10.0%</td> </tr> <tr> <td>C<0.047</td> <td>≤5.0%</td> </tr> <tr> <td rowspan="2">10V、63V</td> <td>C≥0.047</td> <td>≤10.0%</td> </tr> <tr> <td>C<0.047</td> <td>≤7.5%</td> </tr> </tbody> </table>		项目 Item 额定电压 Rated vol.	容量范围 C(μF)	损耗标准 DF	≥50V	所有容量	≤3.5%	25V	所有容量	≤5.0%	16V	C≥0.047	≤10.0%	C<0.047	≤5.0%	10V、63V	C≥0.047	≤10.0%	C<0.047	≤7.5%	
	项目 Item 额定电压 Rated vol.	容量范围 C(μF)	损耗标准 DF																				
	≥50V	所有容量	≤3.5%																				
	25V	所有容量	≤5.0%																				
	16V	C≥0.047	≤10.0%																				
C<0.047		≤5.0%																					
10V、63V	C≥0.047	≤10.0%																					
	C<0.047	≤7.5%																					



四川华瓷科技有限公司

编号 No.	项目 Item	技术要求 Technical requirements	测试方法 Test Method and Remarks												
5	绝缘电阻(IR) Insulation Resistance	I类 Class I (C0G,C0H)	<table border="1"> <tr> <td>容量范围 Capacitance range</td> <td>绝缘电阻标准 Standard</td> <td>测量电压 Measuring voltage</td> <td>额定电压 Rated voltage</td> </tr> <tr> <td>$C \leq 10 \text{ nF}$</td> <td>$R_i \geq 50000 \text{ M}\Omega$</td> <td>测试时间 Duration</td> <td>60±5 秒</td> </tr> <tr> <td>$C > 10 \text{ nF}$</td> <td>$R_i \cdot C_R \geq 500 \text{ S}$</td> <td>测试电流 Charge/discharge current</td> <td>≤50mA</td> </tr> </table>	容量范围 Capacitance range	绝缘电阻标准 Standard	测量电压 Measuring voltage	额定电压 Rated voltage	$C \leq 10 \text{ nF}$	$R_i \geq 50000 \text{ M}\Omega$	测试时间 Duration	60±5 秒	$C > 10 \text{ nF}$	$R_i \cdot C_R \geq 500 \text{ S}$	测试电流 Charge/discharge current	≤50mA
		容量范围 Capacitance range	绝缘电阻标准 Standard	测量电压 Measuring voltage	额定电压 Rated voltage										
		$C \leq 10 \text{ nF}$	$R_i \geq 50000 \text{ M}\Omega$	测试时间 Duration	60±5 秒										
		$C > 10 \text{ nF}$	$R_i \cdot C_R \geq 500 \text{ S}$	测试电流 Charge/discharge current	≤50mA										
		II类 Class II (X7R/X5R X7S/X6S)	<table border="1"> <tr> <td>容量范围 Capacitance range</td> <td>绝缘电阻标准 Standard</td> <td>测试温度 Test temperature</td> <td>25±3℃</td> </tr> <tr> <td>$C \leq 25 \text{ nF}$</td> <td>$R_i \geq 10000 \text{ M}\Omega$</td> <td>测试湿度 Test humidity</td> <td>≤75%</td> </tr> <tr> <td>$C > 25 \text{ nF}$</td> <td>$R_i \cdot C_R > 100 \text{ S}$</td> <td></td> <td></td> </tr> </table>	容量范围 Capacitance range	绝缘电阻标准 Standard	测试温度 Test temperature	25±3℃	$C \leq 25 \text{ nF}$	$R_i \geq 10000 \text{ M}\Omega$	测试湿度 Test humidity	≤75%	$C > 25 \text{ nF}$	$R_i \cdot C_R > 100 \text{ S}$		
		容量范围 Capacitance range	绝缘电阻标准 Standard	测试温度 Test temperature	25±3℃										
$C \leq 25 \text{ nF}$	$R_i \geq 10000 \text{ M}\Omega$	测试湿度 Test humidity	≤75%												
$C > 25 \text{ nF}$	$R_i \cdot C_R > 100 \text{ S}$														

9-2 可靠性测试：Reliability test

编号 No.	项目 Item	技术要求 Technical requirements	测试方法 Test Method and Remarks										
6	介质耐电强度 (DWV) Dielectric Withstanding Voltage	不应有介质被击穿或损伤 No breakdown or damage.	测量电压： I类：300%额定电压；II类：250%额定电压 时间：1~5 秒 充/放电电流：不应超过 50mA Measuring Voltage: Class I :300% Rated voltage Class II :250% Rated voltage Duration: 1~5s Charge/ Discharge Current: 50mA max.										
7	可焊性 Solderability	上锡率应大于 95% , 外观：无可见损伤。 At least 95% of the terminal electrode is covered by new solder. Visual Appearance: No visible damage.	将电容在 80~120℃的温度下预热 10~30 秒。 Preheating conditions:80 to 120℃; 10~30s. <table border="1"> <tr> <td>有铅焊料：(Sn/Pb : 63/37) 浸锡温度: 235±5℃ 浸锡时间: 2±0.5s</td> <td>无铅焊料： 浸锡温度: 245±5℃ 浸锡时间: 2±0.5s</td> </tr> <tr> <td>Solder Temperature: 235±5℃ Duration: 2±0.5s</td> <td>Solder Temperature: 245±5℃ Duration: 2±0.5s</td> </tr> </table>	有铅焊料：(Sn/Pb : 63/37) 浸锡温度: 235±5℃ 浸锡时间: 2±0.5s	无铅焊料： 浸锡温度: 245±5℃ 浸锡时间: 2±0.5s	Solder Temperature: 235±5℃ Duration: 2±0.5s	Solder Temperature: 245±5℃ Duration: 2±0.5s						
有铅焊料：(Sn/Pb : 63/37) 浸锡温度: 235±5℃ 浸锡时间: 2±0.5s	无铅焊料： 浸锡温度: 245±5℃ 浸锡时间: 2±0.5s												
Solder Temperature: 235±5℃ Duration: 2±0.5s	Solder Temperature: 245±5℃ Duration: 2±0.5s												
8	端头结合强度 Termination Adhesion	外观无可见损伤 No visible damage	<table border="1"> <tr> <th>型号 Type</th> <th>施加的力 Applied Force</th> <th>时间 Time</th> </tr> <tr> <td>0201</td> <td>2N</td> <td rowspan="3">10±1S</td> </tr> <tr> <td>0402&0603& 0805</td> <td>5N</td> </tr> <tr> <td>≥1206</td> <td>10N</td> </tr> </table>	型号 Type	施加的力 Applied Force	时间 Time	0201	2N	10±1S	0402&0603& 0805	5N	≥1206	10N
型号 Type	施加的力 Applied Force	时间 Time											
0201	2N	10±1S											
0402&0603& 0805	5N												
≥1206	10N												



四川华瓷科技有限公司

编号 No.	项目 Item	技术要求 Technical requirements	测试方法 Test Method and Remarks												
9	耐焊接热 Resistance to Soldering Heat	<p>1. 电性能要求: Electrical performance requirements</p> <table border="1" data-bbox="406 526 925 884"> <tr> <td style="text-align: center;">类别 classification 项目 Item</td> <td style="text-align: center;">NPO (COG、COH)</td> <td style="text-align: center;">X7R/X5 R/X7S/X6S</td> </tr> <tr> <td style="text-align: center;">ΔC/C</td> <td style="text-align: center;">≤±0.5%</td> <td style="text-align: center;">-5%~+10%</td> </tr> <tr> <td style="text-align: center;">DF</td> <td colspan="2" style="text-align: center;">同初始标准 Same to initial value.</td> </tr> <tr> <td style="text-align: center;">IR</td> <td colspan="2" style="text-align: center;">同初始标准 Same to initial value.</td> </tr> </table> <p>2. 外观: 无可见损伤, 上锡率: ≥95% Appearance :No visible damage. At least 95% of the terminal electrode is covered by new solder.</p>	类别 classification 项目 Item	NPO (COG、COH)	X7R/X5 R/X7S/X6S	ΔC/C	≤±0.5%	-5%~+10%	DF	同初始标准 Same to initial value.		IR	同初始标准 Same to initial value.		<p>初始测量前 (仅限 II 类): 预处理* 将电容在 100~200℃ 的温度下预热 2±0.5 分钟. 浸锡温度: 265±5℃ 浸锡时间: 10±1s 然后取出溶剂清洗干净, 在 10 倍以上的显微镜底下观察. 放置时间: 24±2 小时 放置条件: 室温 (1210 及以上规格采用回流焊试验)</p> <p>Before the initial measurement (only for class II): Note 1 Preheating conditions: 100 to 200℃; 2±0.5min. Solder Temperature: 265±5℃ Duration: 10±1s Clean the capacitor with solvent and examine it with a 10X(min.) microscope. Recovery Time: 24±2h Recovery condition: Room temperature (1210 and Above : Reflow Soldering)</p>
类别 classification 项目 Item	NPO (COG、COH)	X7R/X5 R/X7S/X6S													
ΔC/C	≤±0.5%	-5%~+10%													
DF	同初始标准 Same to initial value.														
IR	同初始标准 Same to initial value.														
10	抗弯曲强度 Resistance to Flexure of Substrate (Bending Strength)	<p>1、ΔC/C : ≤±10% ;</p> <p>2、外观: 无可见损伤. Appearance: No visible damage.</p>	<p>初始测量前 (仅限 II 类): 预处理* 试验基板 : PCB 厚度 : 1.6±0.2mm 弯曲 : 1mm 施压速度 : 1mm/sec. 保持时间 : 5±1s , 然后测量。</p> <p style="text-align: right;">单位 Unit : mm</p> <div data-bbox="973 1456 1460 1769" style="text-align: center;"> </div> <p>Before the initial measurement (only for class II): Note 1 Test Board: PCB Thickness : 1.6±0.2mm Flexure : 1mm. Holding time: 5±1s Pressurization Speed : 1mm/sec. Then measure.</p>												



四川华瓷科技有限公司

编号 No.	项目 Item	技术要求 Technical requirements	测试方法 Test Method and Remarks																																				
11	潮湿 试验 (稳态) Moisture Resistance (Steady State)	$\Delta C/C$	试验前和试验后 (仅限 II 类): 预处理* 温度: $40\pm 2^{\circ}\text{C}$ 湿度: 90%~95%RH 时间: 500 小时 放置时间: 24 ± 2 小时, 放置条件: 室温, 然后测试。 Pre-test treatment and Post-test treatment (only for class II): Note 1 Temperature: $40\pm 2^{\circ}\text{C}$ Humidity: 90%~95%RH Duration: 500h Recovery Time: 24 ± 2 h, Recovery condition: Room temperature, then measure.																																				
		DF																																					
		IR																																					
				外观 Appearance	无损伤 No visible damage.																																		
12	温度循环 Temperature Cycle	<table border="1"> <thead> <tr> <th>类别</th> <th>$\Delta C/C$ 标准</th> </tr> </thead> <tbody> <tr> <td>I 类 (C0G,C0H)</td> <td>$\leq \pm 1\%$ 或 $\pm 1\text{pF}$, 取两者中最大者</td> </tr> <tr> <td>II 类 (X7R,X5R,X7S,X6S)</td> <td>$\leq \pm 10\%$</td> </tr> </tbody> </table>	类别	$\Delta C/C$ 标准	I 类 (C0G,C0H)	$\leq \pm 1\%$ 或 $\pm 1\text{pF}$, 取两者中最大者	II 类 (X7R,X5R,X7S,X6S)	$\leq \pm 10\%$	1. 预处理* (II 类) 2. 初始测量: 循环次数: 5 次, 一个循环分以下 4 步: <table border="1"> <thead> <tr> <th>阶段</th> <th>温度 ($^{\circ}\text{C}$)</th> <th>时间(分钟)</th> </tr> </thead> <tbody> <tr> <td>第 1 步</td> <td>下限温度: (-55)</td> <td>30</td> </tr> <tr> <td>第 2 步</td> <td>常 温: (+20)</td> <td>2~3</td> </tr> <tr> <td>第 3 步</td> <td>上限温度: (C0G、C0H、X7R、X7S : +125), (X5R : +85)、(X6S : +105)</td> <td>30</td> </tr> <tr> <td>第 4 步</td> <td>常 温: (+20)</td> <td>2~3</td> </tr> </tbody> </table> 3. 放置时间: 24 ± 2 小时, 放置条件: 室温, 然后测试。 1. Pretreatment (only for class2 capacitor): Note 1. 2. Initial Measurement : Cycling Times: 5 times, 1 cycle, 4 steps: <table border="1"> <thead> <tr> <th>Step</th> <th>Temperature ($^{\circ}\text{C}$)</th> <th>ime (min.)</th> </tr> </thead> <tbody> <tr> <td>1</td> <td>Low- category temp. (-55)</td> <td>30</td> </tr> <tr> <td>2</td> <td>Normal temp. (+20)</td> <td>2~3</td> </tr> <tr> <td>3</td> <td>Up- category temp : (C0G、C0H、X7R、X7S : +125), (X5R : +85)、(X6S : +105)</td> <td>30</td> </tr> <tr> <td>4</td> <td>Normal temp. (+20)</td> <td>2~3</td> </tr> </tbody> </table> 3. Recovery Time: 24 ± 2 h, Recovery condition: Room temperature, then measure.	阶段	温度 ($^{\circ}\text{C}$)	时间(分钟)	第 1 步	下限温度: (-55)	30	第 2 步	常 温: (+20)	2~3	第 3 步	上限温度: (C0G、C0H、X7R、X7S : +125), (X5R : +85)、(X6S : +105)	30	第 4 步	常 温: (+20)	2~3	Step	Temperature ($^{\circ}\text{C}$)	ime (min.)	1	Low- category temp. (-55)	30	2	Normal temp. (+20)	2~3	3	Up- category temp : (C0G、C0H、X7R、X7S : +125), (X5R : +85)、(X6S : +105)	30	4	Normal temp. (+20)	2~3
		类别	$\Delta C/C$ 标准																																				
		I 类 (C0G,C0H)	$\leq \pm 1\%$ 或 $\pm 1\text{pF}$, 取两者中最大者																																				
		II 类 (X7R,X5R,X7S,X6S)	$\leq \pm 10\%$																																				
阶段	温度 ($^{\circ}\text{C}$)	时间(分钟)																																					
第 1 步	下限温度: (-55)	30																																					
第 2 步	常 温: (+20)	2~3																																					
第 3 步	上限温度: (C0G、C0H、X7R、X7S : +125), (X5R : +85)、(X6S : +105)	30																																					
第 4 步	常 温: (+20)	2~3																																					
Step	Temperature ($^{\circ}\text{C}$)	ime (min.)																																					
1	Low- category temp. (-55)	30																																					
2	Normal temp. (+20)	2~3																																					
3	Up- category temp : (C0G、C0H、X7R、X7S : +125), (X5R : +85)、(X6S : +105)	30																																					
4	Normal temp. (+20)	2~3																																					
classification	$\Delta C/C$ standard																																						
Class I (C0G,C0H)	$\leq \pm 1\%$ or $\pm 1\text{pF}$, whichever is large																																						
Class II (X7R,X5R, X7S,X6S)	$\leq \pm 10\%$																																						



编号 No.	项目 Item	技术要求 Technical requirements	测试方法 Test Method and Remarks
13	耐久性 Durability	I 类 : (C0G,C0H); $\leq\pm 2\%$ 或 $\pm 1\text{pF}$ 取两者之中较大者 II 类 : (X7R,X5R,X7S,X6S): $\leq\pm 20\%$ Class I : (C0G,C0H); $\leq\pm 2\%$ or $\pm 1\text{pF}$, whichever is larger. Class II : (X7R,X5R,X7S,X6S): $\leq\pm 20\%$	试验前和试验后 (仅限 II 类): 预处理* 低压产品 (< 100V) 电压 : 1.5 倍额定工作电压 时间 : 1000 小时 温度 : 125°C (C0G、C0H、X7R、X7S); 85°C (X5R); 105°C (X6S) 充电电流 : 不应超过 50mA 放置时间 : 24 \pm 2 小时, 放置条件 : 室温, 然后测试。
		≤ 2 倍初始标准 Not more than twice of initial value.	
		I 类 : (C0G,C0H); $R_i \geq 4000\text{M}\Omega$ 或 $R_i \cdot C_R \geq 40\text{S}$ 取两者之中较小者. Class I : (C0G,C0H); $R_i \geq 4000\text{M}\Omega$ 或 $R_i \cdot C_R \geq 40\text{S}$ whichever is smaller. II 类 : (X7R,X5R,X7S,X6S) $R_i \geq 2000\text{M}\Omega$ 或 $R_i \cdot C_R \geq 50\text{S}$ 取两者之中较小者. Class II : (X7R,X5R,X7S,X6S) $R_i \geq 2000\text{M}\Omega$ 或 $R_i \cdot C_R \geq 50\text{S}$ whichever is smaller.	
	外观 Appearance	无损伤 No visible damage.	

备注(Remark):

1、预处理* (仅对 2 类电容器):

将电容器放在上限类别温度或按详细规范中可能规定的更高温度(150°C)下经 1h 后 接着在试验的标准大气条件下恢复 24 \pm 1h。

Note1 : Pretreatment (only for class2 capacitor)

Pretreatment (only for class2 capacitor) is a method to treat the capacitor before measurement. First, place the capacitor in the up-category temperature or other specified higher temperature environment(150°C) for 1hour. Then recovery the capacitor at standard pressure conditions for 24 \pm 1hours.



10、包装 PACKAGE

10-1 纸带卷盘结构 PAPER TAPING



10-1-1 0201、0402 纸带编带尺寸大小。 Dimensions of paper taping for 0201、0402 type.



单位 Unit: mm

代号 Code	A0	B0	W	F*	E	P1	P2*	P0	D0	T
0201	0.37±	0.67±0.	8.00±	3.50±	1.75±	2.00±	2.00±	4.00±0	1.50	0.80
	0.10	10	0.10	0.05	0.10	0.05	0.05	.10	-0/+0.10	Below
0402	0.65±	1.15±	8.00±	3.50±	1.75±	2.00±	2.00±	4.00±0	1.50	0.80
	0.10	0.10	0.10	0.05	0.10	0.05	0.05	.10	-0/+0.10	Below

注意：*表示此处对尺寸的要求非常精确。

Note: The place with "*" means where needs exactly dimensions.



10-1-2 0603, 0805, 1206, 常规尺寸产品的纸带尺寸。

Dimensions of paper taping for 0603, 0805, 1206 types.

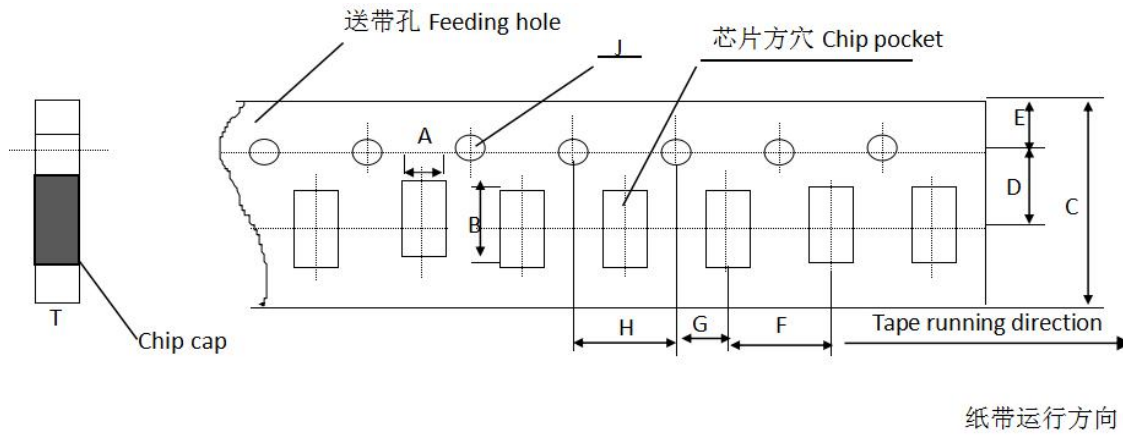

纸带运行方向

单位 Unit: mm

代号 Code 纸带规格 papersize	A	B	C	D*	E	F	G*	H	J	T
0603	1.10 ±0.10	1.90 ±0.10	8.00 ±0.10	3.50 ±0.05	1.75 ±0.10	4.00 ±0.10	2.00 ±0.10	4.00 ±0.10	1.50 -0/+0.10	1.10 Max
0805	1.45 ±0.15	2.30 ±0.15	8.00 ±0.15	3.50 ±0.05	1.75 ±0.10	4.00 ±0.10	2.00 ±0.10	4.00 ±0.10	1.50 -0/+0.10	1.10 Max
1206	1.80 ±0.20	3.40 ±0.20	8.00 ±0.20	3.50 ±0.05	1.75 ±0.10	4.00 ±0.10	2.00 ±0.10	4.00 ±0.10	1.50 -0/+0.10	1.10 Max

注意: *表示此处对尺寸的要求非常精确。 Note: The place with "*" means where needs exactly dimensions.

10-2 塑胶卷盘结构 EMBOSSED TAPING





10-2-1 塑胶带尺寸结构 (适合‘0805~1812’型产品)。

Dimensions of embossed taping for 0805~1812 type.

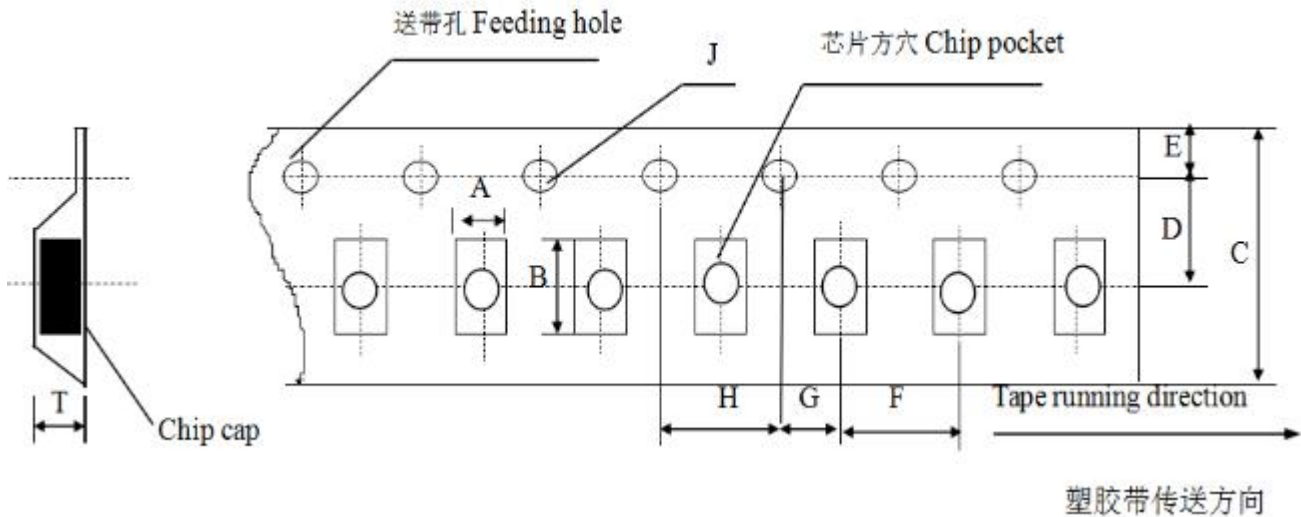

Unit: mm

代号 Code 规格 Tape size	A	B	C	D*	E	F	G*	H	J	T
0805	1.55 ± 0.20	2.35 ± 0.20	8.00 ± 0.20	3.50 ± 0.05	1.75 ± 0.10	4.00 ± 0.10	2.00 ± 0.10	4.00 ± 0.10	1.50 -0/+0.10	1.50 Max
1206	1.95 ± 0.20	3.60 ± 0.20	8.00 ± 0.20	3.50 ± 0.05	1.75 ± 0.10	4.00 ± 0.10	2.00 ± 0.10	4.00 ± 0.1	1.50 -0/+0.10	1.85 Max
1210	2.70 ± 0.10	3.42 ± 0.10	8.00 ± 0.10	3.50 ± 0.05	1.75 ± 0.10	4.00 ± 0.10	2.00 ± 0.05	4.00 ± 0.10	1.55 -0/+0.10	3.2 Max

备注：*表示此处对尺寸的要求非常精确。 Note: The place with "*" means where needs exactly dimensions.

10-3 传送带的前后结构 Structure of leader part and end part of the carrier paper

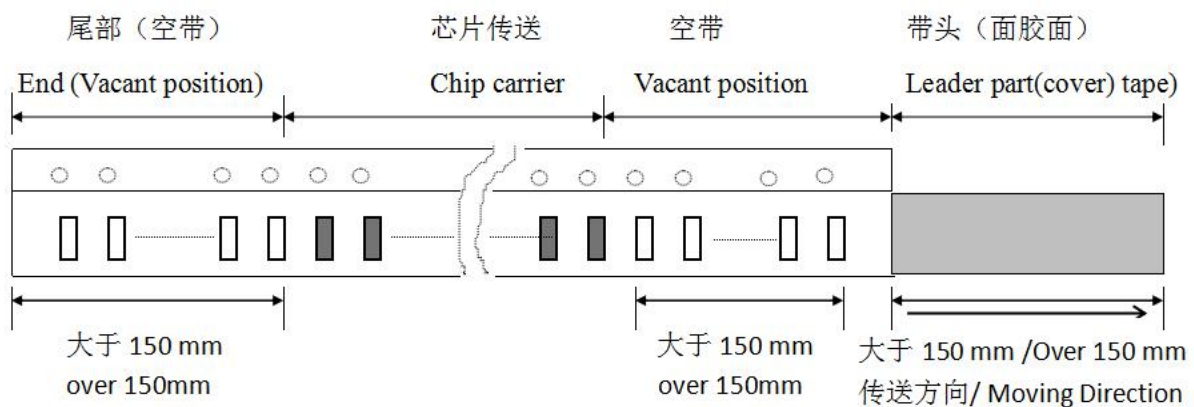



10-3-1 卷盘尺寸 Reel Dimensions

尺寸代码 (CODE)

Unit : mm

卷盘型号	A	B	C	D	E	F	G
8mm/7REEL	$\phi 178 \pm 2.0$	3.0	$\phi 13 \pm 0.5$	$\phi 21 \pm 0.8$	$\phi 50$ 或更大 $\phi 50$ or more	100 ± 1.5	14.4max
13'REEL	$\phi 330 \pm 2.0$	3.0	$\phi 13 \pm 0.5$	$\phi 21 \pm 0.8$	$\phi 50$ 或更大 $\phi 50$ or more	100 ± 1.5	14.4max
12mm/7REEL	$\phi 178 \pm 2.0$	3.0	$\phi 13 \pm 0.5$	$\phi 21 \pm 0.8$	$\phi 50$ 或更大 $\phi 50$ or more	13.4 ± 1.5	18.4max



10-4 卷带的说明 Taping specification

面胶剥离强度 Top tape peeling strength

(a) 纸带 Paper Taping



标准：0.1N < 剥离强度 < 0.7N。 Standard: 0.1N < peeling strength < 0.7N

在剥离时，纸带不能有纸碎，也不能粘在底、面胶上。



No paper dirty remains on the scotch when peeling, and sticks to top and bottom tape.

(b) 塑料胶盘 Embossed Taping



标准：0.1N<剥离强度<0.7N。 Standard: 0.1N < peeling strength < 0.7N

11、储存方法 Storage Methods

确保芯片可焊性良好的贮存期限为 6 个月(在包装好已交付的情况下)。

The guaranteed period for solderability is 6 months (Under deliver package condition).

储存条件/Storage conditions :

储存温度/Temperature 5℃~40℃

储存相对湿度/Relative Humidity 20%~70%

12、使用前的注意事项 Precautions For Use

多层片式瓷介电容器(MLCC)在短路或开路的电路中都有可能失效,在超出本承认书或相关说明书中所述使用频率的恶劣工作环境,或外界机械力超压作用下,电容芯片都有可能着火、燃烧甚至爆炸,所以在使用的时候,首先应考虑按本承认书的有关说明来进行,如有不明之处,请联系我们技术部门。

The Multi-layer Ceramic Capacitors (MLCC) may fail in a short circuit mode or in an open circuit mode when subjected to severe conditions of electrical environment and / or mechanical stress beyond the specified "rating" and specified "conditions" in the specification, which will result in burn out, flaming or glowing in the worst case. Following "precautions for "safety" and Application Notes shall be taken in your major consideration. If you have a question about the precautions for handling, please contact our engineering section or factory.

12-1 焊接的条件与相关图表 Soldering Profile

为避免因温度的突然变化而引起的芯片开裂或局部爆炸的现象发生,请按有关温度曲线图表来进行。

(请参考附页中的图表)

To avoid the crack problem by sudden temperature change, follow the temperature profile in the adjacent graph(refer to the graph in the enclosure page).



12-2 手工焊接 Manual Soldering

手工焊接很容易因为芯片局部受热不均而引起瓷体微裂或局部爆炸的现象,在焊接时,如果操作者不小心,会使烙铁头直接同电容芯片的瓷体部分接触,这样很容易使电容芯片因热冲击而受损或出现其他意外.因此,使用电烙铁手工焊接时应仔细操作,并对电烙铁的尖端的选择和尖端温度控制应多加小心.

Manual soldering can pose a great risk of creating thermal cracks in capacitors. The hot soldering iron tip comes into direct contact with the end terminations, and operator's careless may cause the tip of the soldering iron to come into direct contact with the ceramic body of the capacitor. Therefore the soldering iron must be handled carefully, and pay much attention to the selection of the soldering iron tip and temperature contact of the tip.

12-3 适量的焊料 Optimum Solder Amount for Reflow Soldering

焊料过多
Too much solder

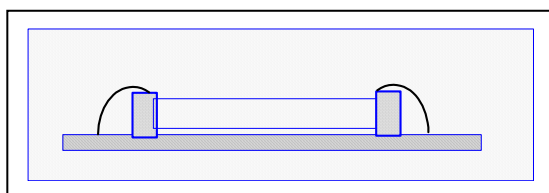

这样会因端头压力过大而可能引起芯片受损
Cracks tend to occur due to large stress.

焊料太少
Not enough solder

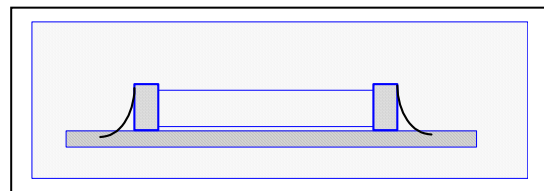

固定力量不足,可能会引起电容芯片与线路接触不良
Weak holding force may cause bad connection between the capacitor and PCB.

12-4 推荐焊料用量 Recommended Soldering amounts

回流焊接的最佳焊料用量
The optimal solder fillet amounts for re-flow soldering

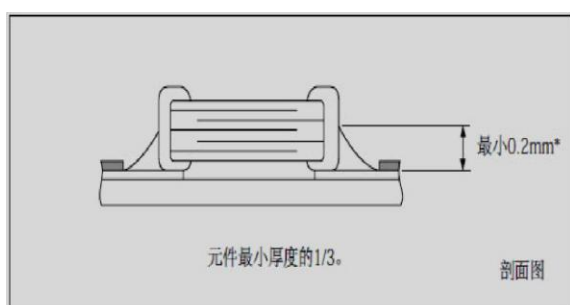

波峰焊接的最佳焊料用量
The optimal solder fillet amounts for wave soldering

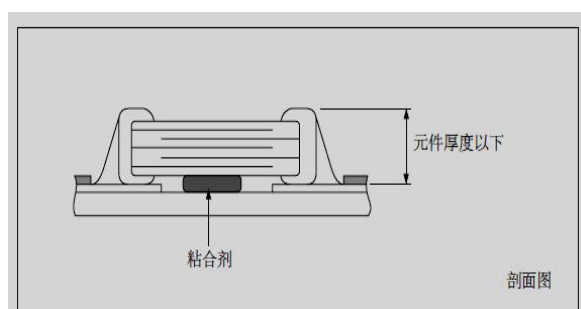

使用烙铁返修时的最佳焊料量
The optimal solder fillet amounts for rewor

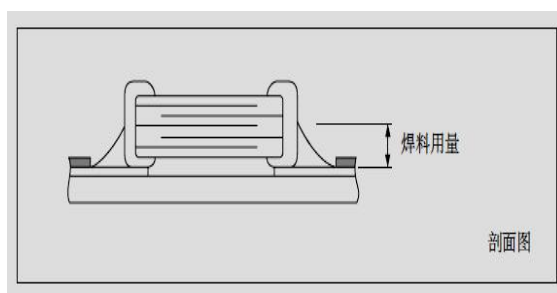



12-5 推荐焊接温度曲线图 The temperature profile for soldering

12-5-1 回流焊接 (Reflow soldering)



有铅回流焊曲线 SnPb Reflow soldering profile



无铅回流焊曲线 Lead-free Reflow soldering profile



在预热时, 需尽可能缩小焊接温度与芯片表面温度之间的温差, 如表 1 所示。

While in preheating, it is required to keep the temperature differential(ΔT) between soldering temperature and the components surface as small as possible, shown in the table 1.

表 1 (table 1)

类型 type	温差 Temperature differential ΔT
HGC0201/HGC0402/ HGC0603/ HGC0805/ HGC1206	$\Delta T \leq 150^{\circ}\text{C}$
HGC1210	$\Delta T \leq 130^{\circ}\text{C}$

12-5-2 波峰焊接 (Wave soldering)

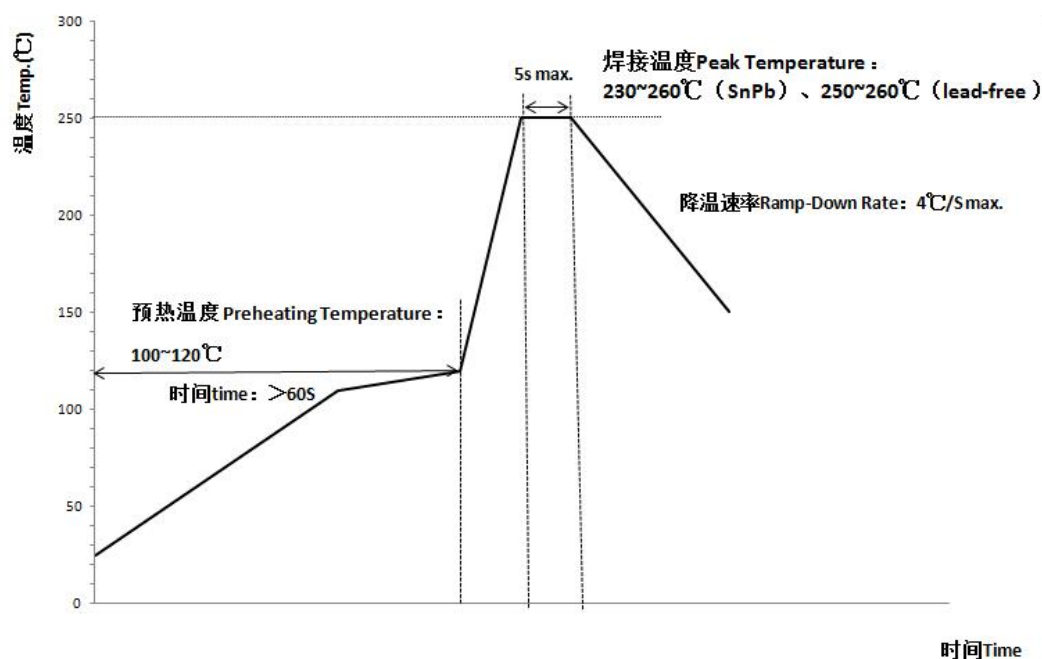

波峰焊曲线 Wave soldering profile

在预热时, 需尽可能缩小焊接温度与芯片表面温度之间的温差, 如表 2 所示。

While in preheating, it is required to keep the temperature differential(ΔT) between soldering temperature and the components surface as small as possible, shown in the table 2.

表 2 table 2

类型 type	温差 Temperature differential ΔT
HGC0603/ HGC0805/ HGC1206	$\Delta T \leq 150^{\circ}\text{C}$



12-5-3 手工焊接 (Hand soldering)

条件 Conditions :

预热 Preheating	烙铁头温度 Temperature of soldering iron head	烙铁功率 Power Of soldering iron	烙铁头直径 Diameter of soldering iron head	焊接时间 Soldering time	锡膏量 Solder paste amount	限制条件 Restricted conditions
$\Delta \leq 130^{\circ}\text{C}$	最高 350°C Highest temperature: 350°C	最大 20W 20W at the highest	建议 1mm 1mm recommended	最长 3s 3s at the longest	$\leq 1/2$ 芯片厚度 $\leq 1/2$ chip thickness	请勿使用烙铁头直接接触陶瓷元件 Please avoid the direct contact between soldering iron head and ceramic components

13、典型的特性数据曲线图 Typical characteristic data graph

1、|Z|-频率特性曲线 |Z| - Frequency Characteristics

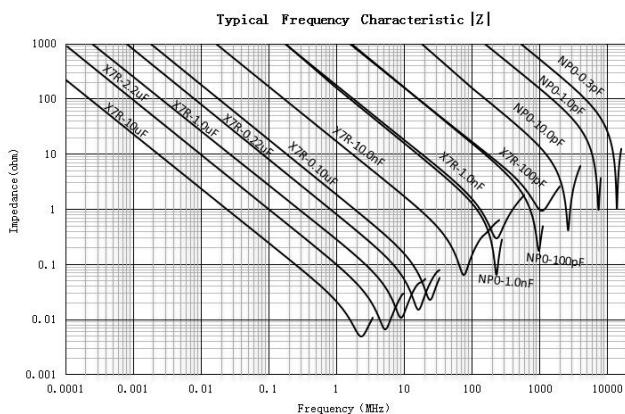

2、温度特性 Temperature Characteristics



3、直流偏压特性 DC Bias Characteristics



注：以上产品特性仅供参考。

Note: The above product characteristics are for reference only.

X-ON Electronics

Largest Supplier of Electrical and Electronic Components

Click to view similar products for [Multilayer Ceramic Capacitors MLCC - SMD/SMT](#) category:

Click to view products by [Chinocera](#) manufacturer:

Other Similar products are found below :

[M39014/02-1218V](#) [M39014/02-1225V](#) [M39014/22-0631](#) [D55342E07B523DR-T/R](#) [NIN-FB391JTRF](#) [NIN-FC2R7JTRF](#)
[NMC0402NPO220J50TRPF](#) [NMC0402X5R105K6.3TRPF](#) [NMC0402X5R224K6.3TRPF](#) [NMC0402X7R103J25TRPF](#)
[NMC0402X7R392K50TRPF](#) [NMC0603NPO201J50TRPF](#) [NMC0603NPO330G50TRPF](#) [NMC0603NPO331F50TRPF](#)
[NMC0603X5R475M6.3TRPF](#) [NMC0603X7R333K16TRPF](#) [NMC0805NPO220J100TRPF](#) [NMC0805NPO820J50TRPF](#)
[NMC1206X7R102K50TRPF](#) [NMC1206X7R106K10TRPLPF](#) [NMC-H0805X7R472K250TRPF](#) [C1608C0G2A221J](#) [C1608X7R1E334K](#)
[C2012C0G2A472J](#) [2220J2K00562KXT](#) [CCR06CG153FSV](#) [CDR33BX104AKUR](#) [CDR33BX683AKUS](#) [CGA3E1X7R1C684K](#)
[CL10C0R8BB8ANNC](#) [M55342H06B20G0R-T/R](#) [C1005X5R0G225M](#) [C2012X7R2E223K](#) [C3216C0G2J272J](#) [D55342E07B35E7R-T/R](#)
[CDR34BX563BKUS](#) [CDR34BX563BKWS](#) [NMC0402NPO220F50TRPF](#) [NMC0402X7R562J25TRPF](#) [NMC0603NPO102J25TRPF](#)
[NMC1206X7R332K50TRPF](#) [NMC-P1206X7R104K250TRPLPF](#) [726632-1](#) [CGA6M3X7R1H225K](#) [CGA5L2X7R2A105K](#)
[CGA3E2X8R1H223K](#) [CDR33BX823AKUR\M500](#) [CDR33BP132BJUR](#) [CDR35BX474AKUR\M500](#) [CDR35BX104BKUR\M500](#)