





## 1、概述 (DESCRIPTION)

适合厂家高密度、高效表面贴装的高压陶瓷电容器。

For high density and high efficiency SMT application.

产品采用 NP0 (C0G、C0H) , X7R 材质制作, 具有电气性能优越、可靠性高的特点。

We can provide NP0(C0G/C0H)/X7R capacitors with high reliability and excellent electrical performance.

## 2、产品特点 (FEATURES):

a、产品尺寸电压高。High voltage in a given case size.

b、高稳定性、高可靠性。High stability and reliability.

## 3、应用领域 (APPLICATIONS):

模拟或数字调制解调器。 Analog & Digital Modems

局域网/广域网接口界面。 LAN/WAN Interface

倍压电器。 Voltage Multipliers

直流变送器。 DC-DC Converters

背光源驱动电路。 Back-lighting Inverters

## 4、型号规格表示方法: HOW TO ORDER

HHV	1206	R7	102	K	202	N	S	L	J
Series 产品系列	Size 尺寸 Inch(mm):	Dielectric 材质	Capacitance 标称容量	Tolerance 精度级别	Rated voltage 额定电压	Termination 端电极类型	Packaging 包装方式	Symbol /Thickness (mm) 厚度代号	Reel Size 卷盘规格
HHV 高压型	0402(1005)	R5=X5R	R75=0.75pF	A=±0.05pF	101=100 Vdc	N=Cu/Ni/Sn	T=纸带	A=0.1mm	J=7Inch
	0603(1608)	R6=X6R	0R5=0.5pF	B=±0.1pF	201=200 Vdc	C=Cu/Resin/ Ni/Sn	Paper taping	B=0.2mm	D=13Inch
	0805(2012)	S6=X6S	1R0=1pF	C=±0.25pF	251=250 Vdc		B=散包装	C=0.3mm	
	1206(3216)	R7=X7R	100=10pF	D=±0.5pF	501=500 Vdc		Bulk	D=0.4mm	K=7Inch 12mm width tape
	1210(3225)	S7=X7S	101=100pF	F=±1%	631=630 Vdc			S=塑胶带	
	1808(4520)	T7=X7T	102=1000pF	G=±2%	102=1k Vdc		Embossed taping	F=0.6mm	
	1812(4532)	R8=X8R	103=10nF	J=±5%	152=1.5k Vdc			L=1.25mm	
		G0=C0G	104=100nF	K=±10%	202=2k Vdc			G=0.7mm	
	H0=C0H	105=1μF	L=±15%	252=2.5k Vdc			H=0.8mm		
		106=10μF	M=±20%	302=3k Vdc		J=1.0mm			
		107=100μF	S=-20%~+50%	402=4k Vdc		L=1.6mm			
				502=5k Vdc		P=1.6mm			
				602=6k Vdc		S=1.8mm			
						U=2.0mm			
						V=2.5mm			
						W=3.0mm			



## 5、温度系数/特性 Temperature Coefficient /Characteristics

介质种类 Dielectric	参考温度点 Reference Temperature Point	标称温度系数 Temperature Coefficient	工作温度范围 Operation Temperature Range
C0G	20°C	0±30 ppm/°C	-55°C ~ 125°C
C0H	20°C	0±60 ppm/°C	-55°C ~ 125°C
X7R	20°C	±15%	-55°C ~ 125°C
X7S	20°C	±22%	-55°C ~ 125°C

备注：I 类电容器标称温度系数和允许偏差是采用温度在 20°C 和 85°C 之间的电容量变化来确定的，而 II 类电容器标称温度系数是按照工作范围之间的电容量相对 20°C 的电容量变化来确定的。

Note: Nominal temperature coefficient and allowed tolerance of class I are decided by the changing of the capacitance between 20°C and 85°C. Nominal temperature coefficient of class II are decided by the temperature of 20°C.

## 6、产品外围尺寸及内部结构 EXTERNAL DIMENSIONS AND STRUCTURE

### 6-1 产品外围尺寸 Product peripheral dimension

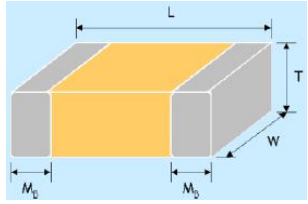
外观 Outline	尺寸 Size Inch (mm)	长度 L (mm)	宽度 W (mm)	厚度 T (mm)/Symbol	焊接方式 Soldering Method*	MB(mm)
	0402 (1005)	1.00±0.05	0.50±0.05	0.50±0.05 E	R	0.25±0.10
	0603 (1608)	1.60±0.20	0.80±0.20	0.80±0.20 H	R / W	0.40±0.15
	0805 (2012)	2.00±0.20	1.25±0.20	0.70±0.10 G	R / W	0.50±0.20
				0.80±0.20 H	R / W	
				1.25±0.20 L	R	
	1206 (3216)	3.20±0.20	1.60±0.20	0.80±0.20 H	R / W	0.60±0.20
				1.00±0.10 J	R	
				1.25±0.20 L		
	1210 (3225)	3.20±0.30	2.50±0.20	1.60±0.20 P	R	0.75±0.25
				1.25±0.20 L		
				2.00±0.20 U		
	1808 (4520)	4.5±0.40	2.0±0.25	2.50±0.20 V	R	0.75±0.25
				1.25±0.20 L		
				1.60±0.20 P		
1812 (4532)	4.5±0.40	3.2±0.30	2.00±0.20 U	R	0.75±0.25	
			1.25±0.20 L			
			1.60±0.20 P			
				2.50±0.30 V		

说明：R=Reflow Soldering 回流焊 W=Wave Soldering 波峰焊



## 6-2 结构 STRUCTURE



## 7、包装标准数量 PACKAGING STANDARD QUANTITY

Size 尺寸	Thickness (mm)/Symbol 厚度代码		Paper tape 纸带	Plastic Tape 胶带
			7"reel	7"reel
0402 (1005)	0.50±0.05	E	10,000	-----
0603 (1608)	0.80±0.20	H	4000	-----
0805 (2012)	0.70±0.10	G	4000	-----
	0.80±0.20	H	4000	-----
	1.25±0.20	L	-----	3000
1206 (3216)	0.70±0.10	G	4000	-----
	0.80±0.20	H	4000	-----
	1.00±0.10	J	-----	3000
	1.25±0.20	L	-----	3000
	1.60±0.20	P	-----	2000
1210 (3225)	1.25±0.20	L	-----	2000
	1.60±0.20	P	-----	2000
	2.00±0.20	U	-----	1000
	2.50±0.30	V	-----	1000
1808 (4520)	1.25±0.20	L		2000
	1.60±0.20	P		2000
	2.00±0.20	U		1000
1812(4532)	1.25±0.20	L	-----	1000
	1.60±0.20	P	-----	1000
	2.00±0.20	U	-----	1000
	2.50±0.30	V	-----	500



# 四川华瓷科技有限公司

## 8、容量范围及其电压 Capacitance Range and rating Voltage

### 8-1 C0G/C0H 介质 Dielectric

DIELECTRIC	C0G/C0H																									
	0402		0603		0805				1206				1210				1808			1812						
(尺寸) SIZE	100	250	100	200 250	100	200 250	500 630	1000	100	200 250	500 630	1000	1500 2000	200 250	500 630	1000	1500 2000	500 630	1000	1500 2000	3000	200 250	500 630	1000	1500 2000	3000
RATED VOLTAGE (VDC)																										
0.5pF (0R5)	E	E	H	H	G	G	H	L																		
1.0pF (1R0)	E	E	H	H	G	G	H	L																		
1.2pF (1R2)	E	E	H	H	G	G	H	L																		
1.5pF (1R5)	E	E	H	H	G	G	H	L	G	G	H	J	J													
1.8pF (1R8)	E	E	H	H	G	G	H	L	G	G	H	J	J													
2.2pF (2R2)	E	E	H	H	G	G	H	L	G	G	H	J	J													
2.7pF (2R7)	E	E	H	H	G	G	H	L	G	G	H	J	J													
3.3pF (3R3)	E	E	H	H	G	G	H	L	G	G	H	J	J													
3.9pF (3R9)	E	E	H	H	G	G	H	L	G	G	H	J	J													
4.7pF (4R7)	E	E	H	H	G	G	H	L	G	G	H	J	J													
5.6pF (5R6)	E	E	H	H	G	G	H	L	G	G	H	J	J													
6.8pF (6R8)	E	E	H	H	G	G	H	L	G	G	H	J	J													
8.2pF (8R2)	E	E	H	H	G	G	H	L	G	G	H	J	J													
10pF (100)	E	E	H	H	G	G	H	L	G	G	H	J	J	L	L	L	L	P	P	P	P	L	L	P	P	P
12pF (120)	E	E	H	H	G	G	H	L	G	G	J	J	J	L	L	L	L	P	P	P	P	L	L	P	P	P
15pF (150)	E	E	H	H	G	G	H	L	G	G	J	J	J	L	L	L	L	P	P	P	P	L	L	P	P	P
18pF (180)	E	E	H	H	G	G	H	L	G	G	J	J	J	L	L	L	L	P	P	P	P	L	L	P	P	P
22pF (220)	E	E	H	H	G	G	H	L	G	G	J	J	J	L	L	L	L	P	P	P	P	L	L	P	P	P
27pF (270)	E	E	H	H	G	G	H	L	G	G	J	J	J	L	L	L	L	P	P	P	P	L	L	P	P	P
33pF (330)	E	E	H	H	G	G	H	L	G	G	J	J	L	L	L	L	L	P	P	P	P	L	L	P	P	P
39pF (390)	E	E	H	H	G	G	H	L	G	G	J	J	L	L	L	L	L	P	P	P	P	L	L	P	P	P
47pF (470)	E	E	H	H	G	G	H	L	G	G	J	J	L	L	L	L	L	P	P	P	P	L	L	P	P	P
56pF (560)	E		H	H	G	G	H		G	G	J	J	L	L	L	L	L	P	P	P	P	L	L	P	P	P
68pF (680)	E		H	H	G	G	H		G	G	J	J	L	L	L	L	L	P	P	P	P	L	L	P	P	P
82pF (820)	E		H	H	G	G	H		G	G	J	J	L	L	L	L	L	P	P	P	P	L	L	P	P	P
100pF (101)	E		H	H	G	G	H		G	G	J	J	L	L	L	L	L	P	P	P	P	L	L	P	P	P
120pF (121)			H	H	G	G	H	L	G	G	J	J	L	L	L	L	L	P	P	P		L	L	P	P	
150pF (151)			H	H	G	G	H	L	G	G	J	J	L	L	L	L	L	P	P	P		L	L	P	P	
180pF (181)			H	H	G	G	H	L	G	G	J	J	L	L	L	L	L	P	P	P		L	L	P	P	
220pF (221)			H	H	G	G	H	L	G	G	J	J	L	L	L	L	L	P	P	P		L	L	P	P	
270pF (271)			H	H	G	G	H	L	G	G	J	J	L	L	L	L	L	P	P			L	L	P	P	
330pF (331)			H	H	G	G	H	L	H	H	J	J	L	L	L	L	L	P	P			L	L	P	P	
390pF (391)			H	H	G	G	H		H	H	J	J	L	L	L	L	L	P	P			L	L	P	P	
470pF (471)			H	H	G	G	H		H	H	J	J	L	L	L	L	L	P	P			L	L	P	P	
560pF (561)			H	H	G	G	H		H	H	L	L	L	L	L	L	L	P	P			L	L	P	P	
680pF (681)			H		G	G	H		H	H	L	L	L	L	L	L	L	P	P			L	L			
820pF (821)			H		G	G	H		H	H	L	L	L	L	L	L	L	P	P			L	L			
1,000pF (102)			H		G	G	H		H	H	L	L	L	L	L	L	L	P	P			L	L			
1,200pF (122)					G				H					L	L	L	L	P				L	L			
1,500pF (152)					G				H					L	P			P				L	L			
1,800pF (182)					G				H					L	P			P				L	L			
2,200pF (222)									H					L	P			P				L	L			
2,700pF (272)														L				P				L				
3,300pF (332)																		P				L				
3,900pF (392)																		P				L				
4,700pF (472)																		P				L				
5,600pF (562)																						L				
6,800pF (682)																						L				
8,200pF (822)																						L				
0.010μF (103)																						L				
0.012μF (123)																						L				
0.015μF (153)																						L				
0.018μF (183)																						L				
0.022μF (223)																						L				
0.027μF (273)																						L				
0.033μF (333)																						L				
0.039μF (393)																						L				
0.047μF (473)																						L				
0.056μF (563)																						L				
0.068μF (683)																						L				
0.082μF (823)																						L				
0.10μF (104)																						L				

Capacitance



# 四川华瓷科技有限公司

## 8-2 X7R 介质 Dielectric

DIELECTRIC		X7R																								
SIZE		0603		0805			1206					1210					1808				1812					
RATED VOLTAGE (VDC)		100	200 250	100	200 250	500 630	100	200 250	500 630	1000	2000	2500	100	200 250	500 630	1000	1500 2000	500 630	1000	1500 2000	2500 3000	200 250	500 630	1000	1500 2000	3000
Capacitance	100pF(101)	H	H	H	H	H	H	H	L	L	L	L	L	L	L	L										
	120pF(121)	H	H	H	H	H	H	H	L	L	L	L	L	L	L	L										
	150pF(151)	H	H	H	H	H	H	H	L	L	L	L	L	L	L	L	P	P	P	P						
	180pF(181)	H	H	H	H	H	H	H	L	L	L	L	L	L	L	L	P	P	P	P						
	220pF(221)	H	H	H	H	H	H	H	L	L	L	L	L	L	L	L	P	P	P	P						
	270pF(271)	H	H	H	H	H	H	H	L	L	L	L	L	L	L	L	P	P	P	P	P	P	P	P	P	P
	330pF(331)	H	H	H	H	H	H	H	L	L	L	L	L	L	L	L	P	P	P	P	P	P	P	P	P	P
	390pF(391)	H	H	H	H	H	H	H	L	L	L	L	L	L	L	L	P	P	P	P	P	P	P	P	P	P
	470pF(471)	H	H	H	H	H	H	H	L	L	L	L	L	L	L	L	P	P	P	P	P	P	P	P	P	P
	560pF(561)	H	H	H	H	H	H	H	L	L	L	L	L	L	L	L	P	P	P	P	P	P	P	P	P	P
	680pF(681)	H	H	H	H	H	H	H	L	L	L	L	L	L	L	L	P	P	P	P	P	P	P	P	P	P
	820pF(821)	H	H	H	H	H	H	H	L	L	L	L	L	L	L	L	P	P	P	P	P	P	P	P	P	P
	1,000pF(102)	H	H	H	H	H	H	H	L	L	L	L	L	L	L	L	P	P	P	P	P	P	P	P	P	P
	1,200pF(122)	H	H	H	H	H	H	H	L	L	P	L	L	L	L	L	P	P	P	P	P	P	P	P	P	P
	1,500pF(152)	H	H	H	H	H	H	H	L	L	P	L	L	L	L	L	P	P	P	P	P	P	P	P	P	P
	1,800pF(182)	H	H	H	H	H	H	H	L	L	P	L	L	L	L	L	P	P	P	P	P	P	P	P	P	P
	2,200pF(222)	H	H	H	H	H	H	H	L	L	P	L	L	L	L	L	P	P	P	P	P	P	P	P	P	P
	2,700pF(272)	H	H	H	H	H	H	H	L	L		L	L	L	L	L	P	P	P	P	P	P	P	P	P	P
	3,300pF(332)	H	H	H	H	H	H	H	L	L	L		L	L	L	L	P	P	P	P	P	P	P	P	P	P
	3,900pF(392)	H	H	H	H	H	H	H	L	L			L	L	L	L	P	P	P	P	P	P	P	P	P	P
	4,700pF(472)	H	H	H	H	H	H	H	L	L			L	L	L	L	P	P	P	P	P	P	P	P	P	P
	5,600pF(562)	H	H	H	H	H	H	H	L	L			L	L	L	L	P	P	P	P	P		P	P	P	P
	6,800pF(682)	H	H	H	H	H	H	H	L	L			L	L	L	L	P	P	P	P			P	P	P	P
	8,200pF(822)	H	H	H	H	L	H	H	L	L			L	L	L	L	P	P	P	P			P	P	P	P
	0.010μF(103)	H	H	H	H	L	H	H	L	L			L	L	L	L	P	P	P	P			P	P	P	P
	0.012μF(123)	H		H	H		H	H	L	L			L	L	L	L	P	P	P	P			P	P	P	
	0.015μF(153)	H		H	H		H	H	L	L			L	L	L	L	P	P	P	P			P	P	P	
	0.018μF(183)	H		H	H		H	H	L	L			L	L	L	L	P	P	P	P			P	P	P	
	0.022μF(223)	H		H	L		H	H	L	L			L	L	L	L	P	P					P	P	P	
	0.027μF(273)	H		L	L		H	H	L	L			L	L	L	L	P						P	P	P	
	0.033μF(333)	H		L	L		H	L	L	L			L	L	L	L	P						P	P	P	
	0.039μF(393)	H		L	L		H	L	L	L			L	L	L	L	P						P	P	P	
	0.047μF(473)	H		L	L		H	L	P	L			L	L	L	L	P						P	P	P	
0.056μF(563)	H		L			H	L		L			L	L	L	L							P	P	S		
0.068μF(683)	H		L			L	L		L			L	L	P								P	P	U		
0.082μF(823)	H		L			L	L		L			L	L	P								P	P			
0.10μF(104)	H		L			L	L		L			L	L	P								P	P	V		
0.12μF(124)			L			L	L		L			L	L									P	P			
0.15μF(154)			L			L	L		L			L	L									P	P			
0.18μF(184)			L			L	P		L			L	P									P	P			
0.22μF(224)			L			L	P		L			L	P									P	P			
0.27μF(274)						L			L			P										P				
0.33μF(334)						L			L			P										P				
0.39μF(394)						P			L			P										P				
0.47μF(474)						P			L			P										P				
0.56μF(564)						P			L			P										P				
0.68μF(684)						P			L			P										U				
0.82μF(824)						P			L			P										U				
1.0μF(105)						P			L			P										U				



## 9、可靠性测试 Reliability Test.

## 9-1 外观及电性能测试 Appearance and electrical performance test

编号 No.	项目 Item	技术要求 Technical requirements	测试方法 Test Method and Remarks			
1	外观 Appearance	没有明显的缺陷或异常 No remarkable defects or abnormalities.	通过显微镜 (×10) Through microscope (×10)			
2	尺寸 size	在规定尺寸范围内 Within the specified size range	使用游标卡尺 Using a vernier caliper			
3	容量 Capacitance	I类 Class I (C0G,C0H)	应符合指定的误差级别 Should be within the specified tolerance. 测试温度 Test temperature: 25±3°C 测试条件 Test condition: C≤1000pF: 1MHz±10%, 1.0±0.2Vrms C > 1000pF: 1KHz±10%, 1.0±0.2Vrms			
		II类 Class II (X7R)	应符合指定的误差级别 Should be within the specified tolerance. 测试温度 Test temperature: 25±3°C 测试条件 Test condition: C≤10μF: 1KHz±10%, 1.0±0.2Vrms C > 10μF: 120±24 Hz, 0.5±0.1Vrms 初始测量前 (仅限II类): 预处理*Before the initial measurement (only for class II):Note1			
4	损耗角正切 (DF, tanδ) Dissipation Factor	I类 Class I (C0G,C0H)	损耗标准 DF Specification	标称容量 Capacitance	测试频率 Measuring Frequency	测试电压 Measuring Voltage
			≤0.56%	Cr < 5 pF	1MHz±10%	1.0±0.2Vrms
			$1.5[(150/Cr)+7] \times 10^{-4}$	5pF≤Cr < 50 pF	1MHz±10%	
			≤0.15%	50pF≤Cr≤1000 pF	1MHz±10%	
		≤0.15%	> 1000 pF	1KHz±10%		
II类 Class II (X7R)	≤2.5%	测试温度 Test temperature: 25±3°C 测试条件 Test condition: C≤10μF: 1KHz±10%, 1.0±0.2Vrms C > 10μF: 120±24 Hz, 0.5±0.1Vrms				



# 四川华瓷科技有限公司

第 7 页 共 19 页

编号 No.	项目 Item	技术要求 Technical requirements	测试方法 Test Method and Remarks																	
5	绝缘电阻 (IR) Insulation Resistance	I类 Class I (C0G,C0H)	<table border="1"> <tr> <td>电容量范围 Capacitance range</td> <td>绝缘电阻范围 Standard</td> </tr> <tr> <td><math>C \leq 10 \text{ nF}</math></td> <td><math>R_i \geq 50000 \text{ M}\Omega</math></td> </tr> <tr> <td><math>C &gt; 10 \text{ nF}</math></td> <td><math>R_i \cdot C_R \geq 500 \text{ S}</math></td> </tr> </table>	电容量范围 Capacitance range	绝缘电阻范围 Standard	$C \leq 10 \text{ nF}$	$R_i \geq 50000 \text{ M}\Omega$	$C > 10 \text{ nF}$	$R_i \cdot C_R \geq 500 \text{ S}$	<table border="1"> <tr> <td>测试电压 Measuring Voltage</td> <td>额定电压 (最高 500V) Rated Voltage (Max 500V)</td> </tr> <tr> <td>测试时间 Duration</td> <td>60±5 秒</td> </tr> <tr> <td>测试电流 Charge/discharge current</td> <td>≤50mA</td> </tr> <tr> <td>测试温度 Test Temperature</td> <td>25±3°C</td> </tr> <tr> <td>测试湿度 Test Humidity</td> <td>≤75%</td> </tr> </table>	测试电压 Measuring Voltage	额定电压 (最高 500V) Rated Voltage (Max 500V)	测试时间 Duration	60±5 秒	测试电流 Charge/discharge current	≤50mA	测试温度 Test Temperature	25±3°C	测试湿度 Test Humidity	≤75%
			电容量范围 Capacitance range	绝缘电阻范围 Standard																
			$C \leq 10 \text{ nF}$	$R_i \geq 50000 \text{ M}\Omega$																
		$C > 10 \text{ nF}$	$R_i \cdot C_R \geq 500 \text{ S}$																	
		测试电压 Measuring Voltage	额定电压 (最高 500V) Rated Voltage (Max 500V)																	
		测试时间 Duration	60±5 秒																	
测试电流 Charge/discharge current	≤50mA																			
测试温度 Test Temperature	25±3°C																			
测试湿度 Test Humidity	≤75%																			
II类 Class II (X7R)	<table border="1"> <tr> <td>电容量范围 Capacitance range</td> <td>绝缘电阻范围 Standard</td> </tr> <tr> <td><math>C \leq 25 \text{ nF}</math></td> <td><math>R_i \geq 10000 \text{ M}\Omega</math></td> </tr> <tr> <td><math>C &gt; 25 \text{ nF}</math></td> <td><math>R_i \cdot C_R &gt; 100 \text{ S}</math></td> </tr> </table>	电容量范围 Capacitance range	绝缘电阻范围 Standard	$C \leq 25 \text{ nF}$	$R_i \geq 10000 \text{ M}\Omega$	$C > 25 \text{ nF}$	$R_i \cdot C_R > 100 \text{ S}$													
	电容量范围 Capacitance range	绝缘电阻范围 Standard																		
	$C \leq 25 \text{ nF}$	$R_i \geq 10000 \text{ M}\Omega$																		
$C > 25 \text{ nF}$	$R_i \cdot C_R > 100 \text{ S}$																			

## 9-2 可靠性测试: Reliability test

编号 No.	项目 Item	技术要求 Technical requirements	测试方法 Test Method and Remarks	
6	介质耐电强度 (DWV) Dielectric Withstanding Voltage	不应有介质被击穿或损伤 No breakdown or damage.	100V ≤ V <sub>r</sub> < 500V: 施加额定电压的 200%, 5 秒, 最大电流不超过 50mA/ Force 200% Rated voltage for 5 second. Max current should not exceed 50 mA.	
			500V ≤ V <sub>r</sub> ≤ 1000V: 施加额定电压的 150%, 5 秒, 最大电流不超过 50mA/ Force 150% Rated voltage for 5 second. Max current should not exceed 50 mA.	
			1000V < V <sub>r</sub> ≤ 2000V: 施加额定电压的 120%, 5 秒, 最大电流不超过 50mA/ Force 120% Rated voltage for 5 second. Max current should not exceed 50 mA.	
			2000V < V <sub>r</sub> ≤ 5000V: 施加额定电压的 120%, 5 秒, 最大电流不超过 10mA/ Force 120% Rated voltage for 5 second. Max current should not exceed 10 mA.	
7	可焊性 Solderability	上锡率应大于 95%, 外观: 无可见损伤。  At least 95% of the terminal electrode is covered by new solder. Visual Appearance: No visible damage.	将电容在 80~120°C 的温度下预热 10~30 秒。 Preheating conditions: 80 to 120°C; 10~30s.	
			<table border="1"> <tr> <td>有铅焊料: (Sn/Pb: 63/37) 浸锡温度: 235±5°C 浸锡时间: 2±0.5s</td> <td>无铅焊料: 浸锡温度: 245±5°C 浸锡时间: 2±0.5s</td> </tr> <tr> <td>Solder Temperature: 235±5°C Duration: 2±0.5s</td> <td>Solder Temperature: 245±5°C Duration: 2±0.5s</td> </tr> </table>	有铅焊料: (Sn/Pb: 63/37) 浸锡温度: 235±5°C 浸锡时间: 2±0.5s
有铅焊料: (Sn/Pb: 63/37) 浸锡温度: 235±5°C 浸锡时间: 2±0.5s	无铅焊料: 浸锡温度: 245±5°C 浸锡时间: 2±0.5s			
Solder Temperature: 235±5°C Duration: 2±0.5s	Solder Temperature: 245±5°C Duration: 2±0.5s			





# 四川华瓷科技有限公司

编号 No.	项目 Item	技术要求 Technical requirements	测试方法 Test Method and Remarks												
8	端头结合强度 Termination Adhesion	外观无可见损伤 No visible damage	施加的力 Applied Force: 0402&0603&0805: 5N; ≥1206:10N 时间 Duration: 10±1S												
9	耐焊接热 Resistance to Soldering Heat	<p>1. 电性能要求: Electrical performance requirements</p> <table border="1"> <thead> <tr> <th>类别 classification 项目 Item</th> <th>NPO (C0G、C0H)</th> <th>X7R</th> </tr> </thead> <tbody> <tr> <td>ΔC/C</td> <td>≤±0.5%</td> <td>-5%~+10%</td> </tr> <tr> <td>DF</td> <td colspan="2">同初始标准 Same to initial value.</td> </tr> <tr> <td>IR</td> <td colspan="2">同初始标准 Same to initial value.</td> </tr> </tbody> </table> <p>2.外观: 无可见损伤, 上锡率: ≥95% Appearance: No visible damage. At least 95% of the terminal electrode is covered by new solder.</p>	类别 classification 项目 Item	NPO (C0G、C0H)	X7R	ΔC/C	≤±0.5%	-5%~+10%	DF	同初始标准 Same to initial value.		IR	同初始标准 Same to initial value.		<p>初始测量前 (仅限II类): 预处理* 将电容在 100~200°C的温度下预热 2±0.5 分钟. 浸锡温度: 265±5°C 浸锡时间: 10±1s 然后取出溶剂清洗干净,在 10 倍以上的显微镜底下观察. 放置时间: 24±2 小时 放置条件: 室温 (1210 及以上规格采用回流焊方式试验)</p> <p>Before the initial measurement (only for class II):Note1 Preheating conditions: 100 to 200°C; 2±0.5min. Solder Temperature: 265±5°C Duration: 10±1s Clean the capacitor with solvent and examine it with a 10X(min.) microscope. Recovery Time: 24±2h Recovery condition: Room temperature (1210 and Above: Reflow Soldering)</p>
类别 classification 项目 Item	NPO (C0G、C0H)	X7R													
ΔC/C	≤±0.5%	-5%~+10%													
DF	同初始标准 Same to initial value.														
IR	同初始标准 Same to initial value.														
10	抗弯曲强度 Resistance to Flexure of Substrate (Bending Strength)	<p>1、ΔC/C: ≤±10%;</p> <p>2、外观: 无可见损伤。 Appearance: No visible damage.</p>	<p>初始测量前 (仅限II类): 预处理* 试验基板 :PCB 厚度 : 1.6±0.2mm 弯曲 :1mm 施压速度 : 1mm/sec. 保持时间: 5±1s , 然后测量。 单位 Unit : mm</p> <p>Before the initial measurement (only for class II):Note1 Test Board: PCB Thickness: 1.6±0.2mm Flexure :1mm. Pressurization Speed : 1mm/sec. Holding time: 5±1s ,Then measure.</p>												



编号 No.	项目 Item	技术要求 Technical requirements	测试方法 Test Method and Remarks																																										
11	潮湿 试验 (稳态) Moisture Resistance (Steady State)	<p><math>\Delta C/C</math></p> <p>I类 (C0G,C0H) : <math>\leq \pm 2\%</math>或<math>\pm 1pF</math>, 取两者之中较大者. II类 X7R: <math>\leq \pm 10\%</math> ClassI (C0G,C0H) : <math>\leq \pm 2\%</math> or <math>\pm 1pF</math>, whichever is larger. ClassII(X7R): <math>\leq \pm 10\%</math></p> <p>DF</p> <p><math>\leq 2</math> 倍初始标准 Not more than twice of initial value.</p> <p>IR</p> <p>I类 (C0G,C0H): <math>R_i \geq 2500M\Omega</math>或 <math>R_i \cdot C_R \geq 25S</math> 取两者之中较小者. ClassI (C0G,C0H) : <math>R_i \geq 2500M\Omega</math> 或 <math>R_i \cdot C_R \geq 25S</math> whichever is smaller. II类 (X7R): <math>R_i \geq 1000M\Omega</math>或 <math>R_i \cdot C_R \geq 25S</math> 取 两者之中较小者. ClassII (X7R) : <math>R_i \geq 1000M\Omega</math>或 <math>R_i \cdot C_R \geq 25S</math> whichever is smaller.</p> <p>外观 Appearance</p> <p>无损伤 No visible damage.</p>	<p>试验前和试验后 (仅限II类): 预处理*</p> <p>温度: <math>40 \pm 2^\circ C</math> 湿度: 90%~95%RH 时间: 500 小时 充电电流: 不应超过 50mA 放置时间: <math>24 \pm 2</math> 小时, 放置条件: 室温, 然后测试。</p> <p>Pre-test treatment and Post-test treatment (only for class II): Note1 Temperature: <math>40 \pm 2^\circ C</math> Humidity: 90%~95%RH Duration: 500h Charge/Discharge Current: 50mA max. Recovery Time: <math>24 \pm 2h</math>, Recovery condition: Room temperature, then measure.</p>																																										
12	温度循环 Temperature Cycle	<table border="1"> <thead> <tr> <th>类别</th> <th><math>\Delta C/C</math> 标准</th> </tr> </thead> <tbody> <tr> <td>I类 (C0G,C0H)</td> <td><math>\leq \pm 1\%</math>或<math>\pm 1pF</math>, 取两者中最大者</td> </tr> <tr> <td>II类 (X7R)</td> <td><math>\leq \pm 10\%</math></td> </tr> </tbody> </table> <table border="1"> <thead> <tr> <th>classification</th> <th><math>\Delta C/C</math> standard</th> </tr> </thead> <tbody> <tr> <td>ClassI (C0G,C0H)</td> <td><math>\leq \pm 1\%</math> or <math>\pm 1pF</math>, whichever is large</td> </tr> <tr> <td>ClassII(X7R)</td> <td><math>\leq \pm 10\%</math></td> </tr> </tbody> </table>	类别	$\Delta C/C$ 标准	I类 (C0G,C0H)	$\leq \pm 1\%$ 或 $\pm 1pF$ , 取两者中最大者	II类 (X7R)	$\leq \pm 10\%$	classification	$\Delta C/C$ standard	ClassI (C0G,C0H)	$\leq \pm 1\%$ or $\pm 1pF$ , whichever is large	ClassII(X7R)	$\leq \pm 10\%$	<p>1.预处理* (II类)</p> <p>2.初始测量: 循环次数: 5 次,一个循环分以下 4 步:</p> <table border="1"> <thead> <tr> <th>阶段</th> <th>温度 (<math>^\circ C</math>)</th> <th>时间 (分钟)</th> </tr> </thead> <tbody> <tr> <td>第 1 步</td> <td>下限温度: (-55)</td> <td>30</td> </tr> <tr> <td>第 2 步</td> <td>常 温: (+20)</td> <td>2~3</td> </tr> <tr> <td>第 3 步</td> <td>上限温度: (+125)</td> <td>30</td> </tr> <tr> <td>第 4 步</td> <td>常 温: (+20)</td> <td>2~3</td> </tr> </tbody> </table> <p>3.放置时间: <math>24 \pm 2</math> 小时, 放置条件: 室温, 然后测试。</p> <p>1. Pretreatment (only for class2 capacitor): Note1. 2.Initial Measurement: Cycling Times: 5 times, 1 cycle, 4 steps:</p> <table border="1"> <thead> <tr> <th>Step</th> <th>Temperature (<math>^\circ C</math>)</th> <th>Time (min.)</th> </tr> </thead> <tbody> <tr> <td>1</td> <td>Low- category temp. (-55)</td> <td>30</td> </tr> <tr> <td>2</td> <td>Normal temp. (+20)</td> <td>2~3</td> </tr> <tr> <td>3</td> <td>Up- category temp. (+125)</td> <td>30</td> </tr> <tr> <td>4</td> <td>Normal temp. (+20)</td> <td>2~3</td> </tr> </tbody> </table> <p>3.Recovery Time: <math>24 \pm 2h</math>, Recovery condition: Room temperature, then measure.</p>	阶段	温度 ( $^\circ C$ )	时间 (分钟)	第 1 步	下限温度: (-55)	30	第 2 步	常 温: (+20)	2~3	第 3 步	上限温度: (+125)	30	第 4 步	常 温: (+20)	2~3	Step	Temperature ( $^\circ C$ )	Time (min.)	1	Low- category temp. (-55)	30	2	Normal temp. (+20)	2~3	3	Up- category temp. (+125)	30	4	Normal temp. (+20)	2~3
类别	$\Delta C/C$ 标准																																												
I类 (C0G,C0H)	$\leq \pm 1\%$ 或 $\pm 1pF$ , 取两者中最大者																																												
II类 (X7R)	$\leq \pm 10\%$																																												
classification	$\Delta C/C$ standard																																												
ClassI (C0G,C0H)	$\leq \pm 1\%$ or $\pm 1pF$ , whichever is large																																												
ClassII(X7R)	$\leq \pm 10\%$																																												
阶段	温度 ( $^\circ C$ )	时间 (分钟)																																											
第 1 步	下限温度: (-55)	30																																											
第 2 步	常 温: (+20)	2~3																																											
第 3 步	上限温度: (+125)	30																																											
第 4 步	常 温: (+20)	2~3																																											
Step	Temperature ( $^\circ C$ )	Time (min.)																																											
1	Low- category temp. (-55)	30																																											
2	Normal temp. (+20)	2~3																																											
3	Up- category temp. (+125)	30																																											
4	Normal temp. (+20)	2~3																																											



# 四川华瓷科技有限公司

编号 No.	项目 Item	技术要求 Technical requirements	测试方法 Test Method and Remarks																
13	耐久性 Durability	$\Delta C/C$ I类(C0G,C0H): $\leq \pm 2\%$ 或 $\pm 1pF$ 取两者之中较大者 II类(X7R): $\leq \pm 20\%$ ClassI(C0G,C0H): $\leq \pm 2\%$ or $\pm 1pF$ , whichever is larger. ClassII(X7R): $\leq \pm 20\%$	电压 Applied Voltage: <table border="1"> <thead> <tr> <th>项目</th> <th>条件</th> </tr> </thead> <tbody> <tr> <td>&lt; 500V 额定电压 &lt; 500V Rated Voltage</td> <td>2 倍工作电压 2 Multiple</td> </tr> <tr> <td>500V ≤ 额定电压 ≤ 1000V 500V ≤ Rated Voltage ≤ 1000V</td> <td>1.5 倍工作电压 1.5 Multiple</td> </tr> <tr> <td>额定电压 &gt; 1000V &gt; 1000V Rated Voltage</td> <td>1.2 倍工作电压 1.2 Multiple</td> </tr> <tr> <td>时间 Duration</td> <td>1000 小时 h</td> </tr> <tr> <td>温度 Temperature</td> <td>125°C</td> </tr> <tr> <td>充电电流 Charge/Discharge Current</td> <td>不应超过 50mA 50mA max.</td> </tr> <tr> <td>室温下放置时间 Room temperature Recovery condition:</td> <td>24±2h</td> </tr> </tbody> </table> 试验前和试验后 (仅限II类): 预处理* Pre-test treatment and Post-test treatment (only for class II): Note1	项目	条件	< 500V 额定电压 < 500V Rated Voltage	2 倍工作电压 2 Multiple	500V ≤ 额定电压 ≤ 1000V 500V ≤ Rated Voltage ≤ 1000V	1.5 倍工作电压 1.5 Multiple	额定电压 > 1000V > 1000V Rated Voltage	1.2 倍工作电压 1.2 Multiple	时间 Duration	1000 小时 h	温度 Temperature	125°C	充电电流 Charge/Discharge Current	不应超过 50mA 50mA max.	室温下放置时间 Room temperature Recovery condition:	24±2h
		项目		条件															
		< 500V 额定电压 < 500V Rated Voltage		2 倍工作电压 2 Multiple															
	500V ≤ 额定电压 ≤ 1000V 500V ≤ Rated Voltage ≤ 1000V	1.5 倍工作电压 1.5 Multiple																	
额定电压 > 1000V > 1000V Rated Voltage	1.2 倍工作电压 1.2 Multiple																		
时间 Duration	1000 小时 h																		
温度 Temperature	125°C																		
充电电流 Charge/Discharge Current	不应超过 50mA 50mA max.																		
室温下放置时间 Room temperature Recovery condition:	24±2h																		
DF	$\leq 2$ 倍初始标准 Not more than twice of initial value.																		
IR	I类(C0G,C0H): $R_i \geq 4000M\Omega$ 或 $R_i \cdot C_R \geq 40S$ 取两者之中较小者 ClassI(C0G,C0H): $R_i \geq 4000M\Omega$ 或 $R_i \cdot C_R \geq 40S$ whichever is smaller.																		
	II类(X7R): $R_i \geq 2000M\Omega$ 或 $R_i \cdot C_R \geq 50S$ , 取两者之中较小者. ClassII(X7R): $R_i \geq 2000M\Omega$ 或 $R_i \cdot C_R \geq 50S$ , whichever is smaller.																		
外观 Appearance	无损伤 No visible damage.																		

备注(Remark):

预处理\* (仅对 2 类电容器):

将电容器放在上限类别温度或按详细规范中可能规定的更高温度下(150°C)经 1h 后,接着在试验的标准大气条件下恢复 24±1h.

Note1: Pretreatment (only for class2 capacitor)

Pretreatment (only for class2 capacitor) is a method to treat the capacitor before measurement. First, place the capacitor in the up-category temperature or other specified higher temperature environment (150°C) for 1hour. Then recovery the capacitor at standard pressure conditions for 24±1hours.

## 10、包装 PACKAGE

### 10-1 纸带卷盘结构 PAPER TAPING





# 四川华瓷科技有限公司

## 10-1-1 0402 纸带编带尺寸大小。 Dimensions of paper taping for 0402 type.

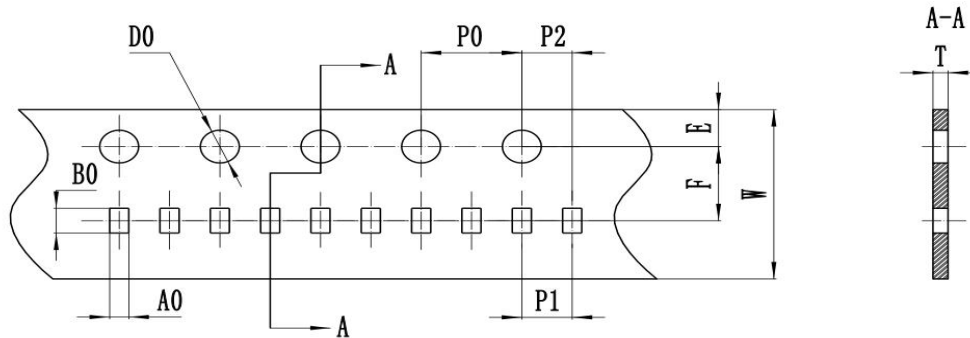

单位 Unit: mm

代号 Code	A0	B0	W	F*	E	P1	P2*	P0	D0	T
0402	0.65±0.10	1.15± 0.10	8.00± 0.10	3.50± 0.05	1.75± 0.10	2.00± 0.05	2.00± 0.05	4.00± 0.10	1.50 -0/+0.10	0.80 Below

注意: \*表示此处对尺寸的要求非常精确。 Note: The place with "\*" means where needs exactly dimensions.

## 10-1-2 0603, 0805, 1206, 常规尺寸产品的纸带尺寸。

### Dimensions of paper taping for 0603, 0805, 1206 types.

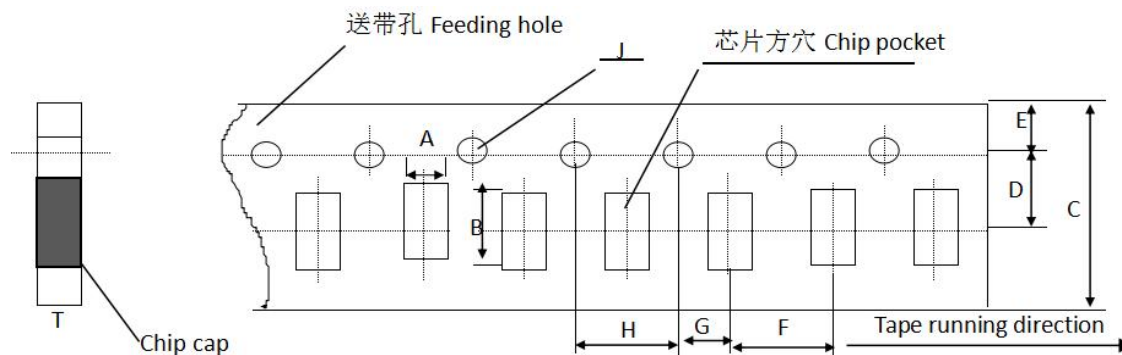

纸带运行方向

单位 Unit: mm

代号 Code 纸带规格 paper size	A	B	C	D*	E	F	G*	H	J	T
0603	1.10 ±0.10	1.90 ±0.10	8.00 ±0.10	3.50 ±0.05	1.75 ±0.10	4.00 ±0.10	2.00 ±0.10	4.00 ±0.10	1.50 -0/+0.10	1.10 Max
0805	1.45 ±0.15	2.30 ±0.15	8.0 ±0.15	3.50 ±0.05	1.75 ±0.10	4.00 ±0.10	2.00 ±0.10	4.00 ±0.10	1.50 -0/+0.10	1.10 Max
1206	1.80 ±0.20	3.40 ±0.20	8.00 ±0.20	3.50 ±0.05	1.75 ±0.10	4.00 ±0.10	2.00 ±0.10	4.00 ±0.10	1.50 -0/+0.10	1.10 Max



注意: \*表示此处对尺寸的要求非常精确。 Note: The place with "\*" means where needs exactly dimensions.

## 10-2 塑胶卷盘结构 EMBOSED TAPING

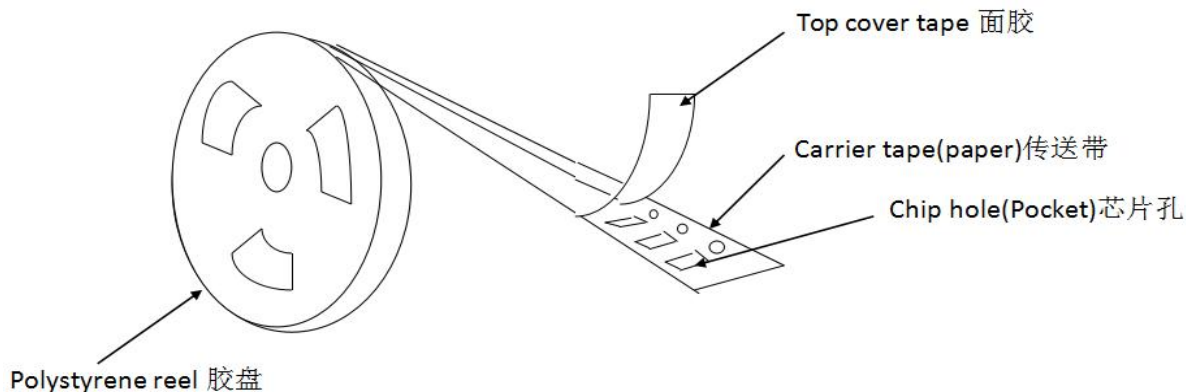

### 10-2-1 塑胶带尺寸结构 (适合‘0805~1812’型产品)。

Dimensions of embossed taping for 0805~1812 type.



Unit: mm

代号 Code 规格 Tape size	A	B	C	D*	E	F	G*	H	J	T
0805	1.55 ± 0.20	2.35 ± 0.20	8.00 ± 0.20	3.50 ± 0.05	1.75 ± 0.10	4.00 ± 0.10	2.00 ± 0.10	4.00 ± 0.10	1.50 -0/+0.10	1.50 Max
1206	1.95 ± 0.20	3.60 ± 0.20	8.00 ± 0.20	3.50 ± 0.05	1.75 ± 0.10	4.00 ± 0.10	2.00 ± 0.10	4.00 ± 0.1	1.50 -0/+0.10	1.85 Max
1210	2.70 ± 0.10	3.42 ± 0.10	8.00 ± 0.10	3.50 ± 0.05	1.75 ± 0.10	4.00 ± 0.10	2.00 ± 0.05	4.00 ± 0.10	1.55 -0/+0.10	3.2 Max
1808	2.20 ± 0.10	4.95 ± 0.10	12.00 ± 0.10	5.50 ± 0.05	1.75 ± 0.10	4.00 ± 0.10	2.00 ± 0.05	4.00 ± 0.10	1.50 -0/+0.10	3.0 Max
1812	3.66 ± 0.10	4.95 ± 0.10	12.00 ± 0.10	5.50 ± 0.05	1.75 ± 0.10	8.00 ± 0.10	2.00 ± 0.05	4.00 ± 0.10	1.55 -0/+0.10	4.0 Max



# 四川华瓷科技有限公司

备注: \*表示此处对尺寸的要求非常精确。 Note: The place with "\*" means where needs exactly dimensions.

### 10-3 传送带的前后结构 Structure of leader part and end part of the carrier paper



### 10-3-1 卷盘尺寸 Reel Dimensions

尺寸代码 (CODE)

Unit: mm

卷盘型号	A	B	C	D	E	F	G
8mm/7REEL	$\phi 178 \pm 2.0$	3.0	$\phi 13 \pm 0.5$	$\phi 21 \pm 0.8$	$\phi 50$ 或更大 $\phi 50$ or more	$100 \pm 1.5$	14.4max
13'REEL	$\phi 330 \pm 2.0$	3.0	$\phi 13 \pm 0.5$	$\phi 21 \pm 0.8$	$\phi 50$ 或更大 $\phi 50$ or more	$100 \pm 1.5$	14.4max
12mm/7REEL	$\phi 178 \pm 2.0$	3.0	$\phi 13 \pm 0.5$	$\phi 21 \pm 0.8$	$\phi 50$ 或更大 $\phi 50$ or more	$13.4 \pm 1.5$	18.4max



### 10-4 卷带的说明 Taping specification

面胶剥离强度 Top tape peeling strength

(a) 纸带 Paper Taping



标准：0.1N < 剥离强度 < 0.7N。 Standard: 0.1N < peeling strength < 0.7N

在剥离时，纸带不能有纸碎，也不能粘在底、面胶上。

No paper dirty remains on the scotch when peeling, and sticks to top and bottom tape.

#### (b) 塑料胶盘 Embossed Taping



标准：0.1N < 剥离强度 < 0.7N。 Standard: 0.1N < peeling strength < 0.7N

## 11、储存方法 Storage Methods

确保芯片可焊性良好的贮存期限为 6 个月(在包装好已交付的情况下)。

The guaranteed period for solderability is 6 months (Under deliver package condition).

储存条件/Storage conditions:

储存温度/Temperature 5°C~40°C

储存相对湿度/Relative Humidity 20%~70%

## 12、使用前的注意事项 Precautions For Use

多层片式瓷介电容器(MLCC)在短路或开路的电路中都有可能失效,在超出本承认书或相关说明书中所述使用频率的恶劣工作环境,或外界机械力超压作用下,电容芯片都有可能着火、燃烧甚至爆炸,所以在使用的时候,首先应考虑按本承认书的有关说明来进行,如有不明之处,请联系我们技术部门。



The Multi-layer Ceramic Capacitors (MLCC) may fail in a short circuit mode in an open circuit mode when subjected to severe conditions of electrical environment and / or mechanical stress beyond the specified “rating” and specified “conditions” in the specification, which will result in burn out, flaming or glowing in the worst case. Following “precautions for “safety” and Application Notes shall be taken in your major consideration. If you have a question about the precautions for handling, please contact our engineering section or factory.

### 12-1. 焊接的条件与相关图表 Soldering Profile

为避免因温度的突然变化而引起的芯片开裂或局部爆炸的现象发生,请按有关温度曲线图表来进行。

(请参考附页中的图表)

To avoid the crack problem by sudden temperature change, follow the temperature profile in the adjacent graph(refer to the graph in the enclosure page).

### 12-2 手工焊接 Manual Soldering

手工焊接很容易因为芯片局部受热不均而引起瓷体微裂或局部爆炸的现象,在焊接时,如果操作者不小心,会使烙铁头直接同电容芯片的瓷体部分接触,这样很容易使电容芯片因热冲击而受损或出现其他意外.因此,使用电烙铁手工焊接时应仔细操作,并对电烙铁的尖端的选择和尖端温度控制应多加小心.

Manual soldering can pose a great risk of creating thermal cracks in capacitors. The hot soldering iron tip comes into direct contact with the end terminations, and operator’s careless may cause the tip of the soldering iron to come into direct contact with the ceramic body of the capacitor. Therefore the soldering iron must be handled carefully, and pay much attention to the selection of the soldering iron tip and temperature contact of the tip.

### 12-3 适量的焊料 Optimum Solder Amount for Reflow Soldering

焊料过多

Too much solder



这样会因端头压力过大而  
可能引起芯片受损

Cracks tend to occur due to large stress.

焊料太少

Not enough solder



固定力量不足,可能会引起  
电容芯片与线路接触不良  
Weak holding force may cause bad connection  
between the capacitor and PCB.





## 12-4 推荐焊料用量 Recommended Soldering amounts

### 回流焊接的最佳焊料用量

The optimal solder fillet amounts for re-flow soldering



### 波峰焊接的最佳焊料用量

The optimal solder fillet amounts for wave soldering



### 使用烙铁返修时的最佳焊料量

The optimal solder fillet amounts for reworking



## 12-5 推荐焊接温度曲线图 The temperature profile for soldering

### 12-5-1 回流焊接 (Re-flow soldering )



有铅回流焊曲线 SnPb Reflow soldering profile

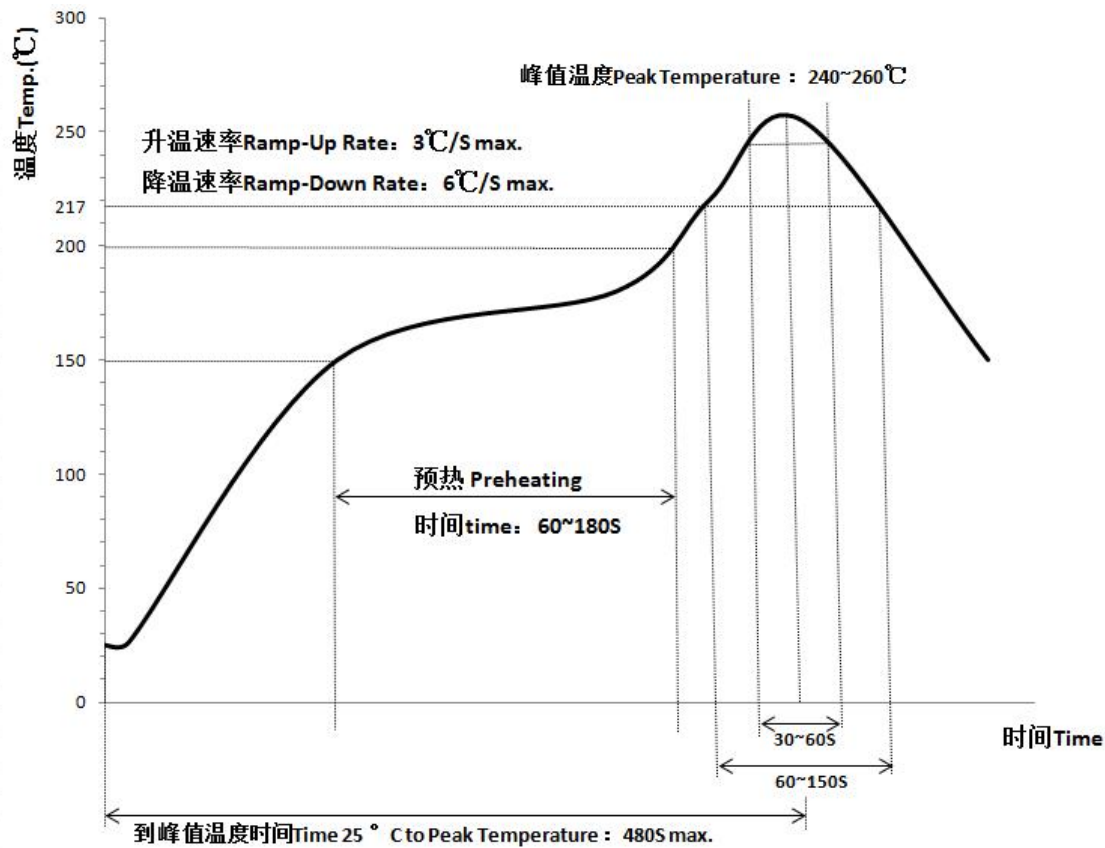

无铅回流焊曲线 Lead-free Reflow soldering profile

在预热时, 需尽可能缩小焊接温度与芯片表面温度之间的温差, 如表 1 所示。

While in preheating, It is required to keep the temperature differential( $\Delta T$ ) between soldering temperature and the components surface as small as possible, shown in the table 1.

表 1 (table 1)

类型 type	温差 Temperature differential $\Delta T$
HHV0603/ HHV0805/ HHV1206	$\Delta T \leq 150^{\circ}\text{C}$
HHV1210/HHV1808/HHV1812	$\Delta T \leq 130^{\circ}\text{C}$



## 12-5-2 波峰焊接 (Wave soldering)



波峰焊曲线 Wave soldering profile

在预热时, 需尽可能缩小焊接温度与芯片表面温度之间的温差, 如表 2 所示。

While in preheating, It is required to keep the temperature differential( $\Delta T$ ) between soldering temperature and the components surface as small as possible, shown in the table 2.

表 2 (table 2)

类型 type	温差 Temperature differential $\Delta T$
HHV0603/ HHV0805/ HHV1206	$\Delta T \leq 150^\circ\text{C}$

## 12-5-3 手工焊接 (Hand soldering)

条件 Conditions:

预热 Preheating	烙铁头温度 Temperature of soldering iron head	烙铁功率 Power Of soldering iron	烙铁头直径 Diameter of soldering iron head	焊接时间 Soldering time	锡膏量 Solder paste amount	限制条件 Restricted conditions
$\Delta \leq 130^\circ\text{C}$	最高 350°C Highest temperature: 350 °C	最大 20W 20W at the highest	建议 1mm 1mm recommended	最长 3s 3s at the longest	$\leq 1/2$ 芯片厚度 $\leq 1/2$ chip thickness	请勿使用烙铁头直接 接触陶瓷元件 Please avoid the direct contact between soldering iron head and ceramic components



## 13、典型的特性数据曲线图 Typical characteristic data graph

### 1、|Z|-频率特性曲线 |Z| - Frequency Characteristics

### 2、温度特性 Temperature Characteristics

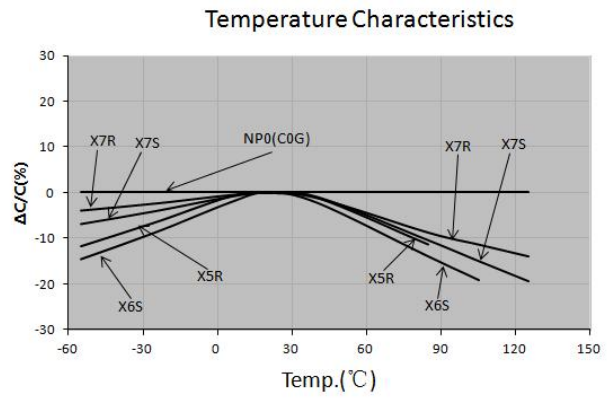
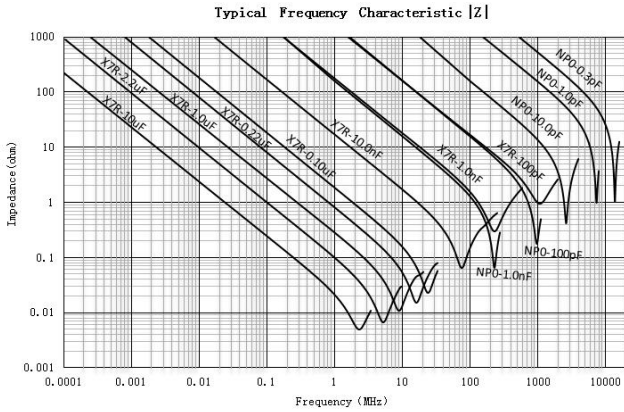

### 3、直流偏压特性 DC Bias Characteristics

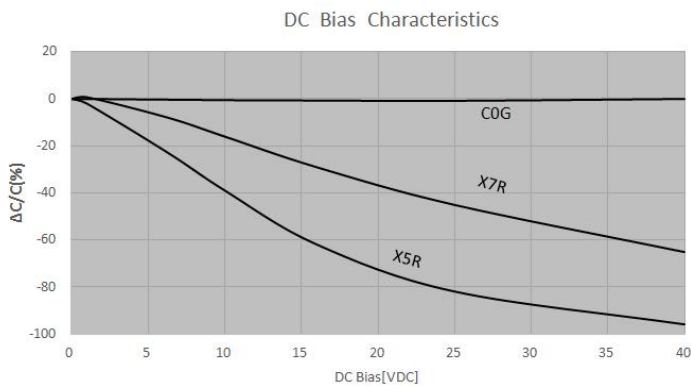

注: 以上产品特性仅供参考。

Note: The above product characteristics are for reference only.

## X-ON Electronics

Largest Supplier of Electrical and Electronic Components

*Click to view similar products for [Multilayer Ceramic Capacitors MLCC - SMD/SMT](#) category:*

*Click to view products by [Chinocera](#) manufacturer:*

Other Similar products are found below :

[M39014/02-1218V](#) [M39014/02-1225V](#) [M39014/22-0631](#) [D55342E07B523DR-T/R](#) [NIN-FB391JTRF](#) [NIN-FC2R7JTRF](#)  
[NMC0402NPO220J50TRPF](#) [NMC0402X5R105K6.3TRPF](#) [NMC0402X5R224K6.3TRPF](#) [NMC0402X7R103J25TRPF](#)  
[NMC0402X7R153K16TRPF](#) [NMC0603NPO101F50TRPF](#) [NMC0603NPO1R8C50TRPF](#) [NMC0603NPO201J50TRPF](#)  
[NMC0603X5R475M6.3TRPF](#) [NMC0805NPO270J50TRPF](#) [NMC0805NPO681F50TRPF](#) [NMC0805NPO820J50TRPF](#)  
[NMC0805X7R224K16TRPLPF](#) [NMC0805X7R224K25TRPF](#) [NMC1206X7R102K50TRPF](#) [NMC1206X7R475K10TRPLPF](#) [NMC-](#)  
[Q0402NPO8R2D200TRPF](#) [C1206C101J1GAC](#) [C1608C0G2A221J](#) [C1608X7R1E334K](#) [C2012C0G2A472J](#) [2220J2K00562KXT](#)  
[1812J2K00332KXT](#) [CDR04BX104AKSR](#) [CDR31BX103AKWR](#) [CDR33BX104AKUR](#) [CDR33BX683AKUS](#) [CGA2B2C0G1H010C](#)  
[CGA2B2C0G1H040C](#) [CGA2B2C0G1H050C](#) [CGA2B2C0G1H060D](#) [CGA2B2C0G1H070D](#) [CGA2B2C0G1H120J](#) [CGA2B2C0G1H151J](#)  
[CGA2B2C0G1H1R5C](#) [CGA2B2C0G1H2R2C](#) [CGA2B2C0G1H390J](#) [CGA2B2C0G1H391J](#) [CGA2B2C0G1H3R3C](#) [CGA2B2C0G1H680J](#)  
[CGA2B2C0G1H6R8D](#) [CGA2B2C0G1H820J](#) [CGA2B2X8R1H152K](#) [CGA2B2X8R1H221K](#)