

## NC7 系列交流接触器

### 1 适用范围

NC7系列交流接触器(以下简称接触器),主要用于交流50Hz(或60Hz),额定工作电压至690V,在AC-3、400V的使用类别下额定工作电流至620A的电路中,主要用于远距离接通和分断电路之用,并可与适当的热过载继电器组成电磁起动器以保护可能发生操作过负荷的电路,接触器适宜于频繁地起动和控制交流电动机。

符合标准:GB/T 14048.4、IEC/EN 60947-4-1。

### 2 型号及含义

产品型号及含义:

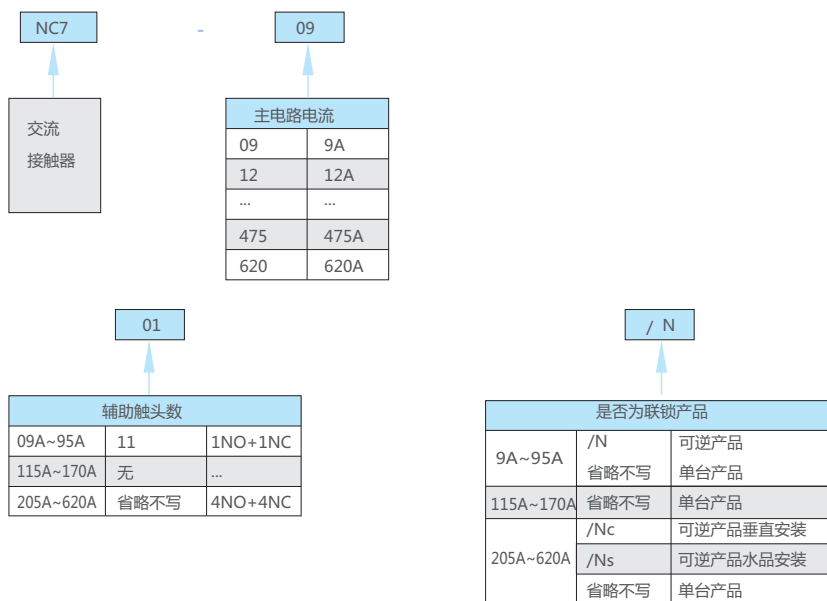

附件型号及含义:

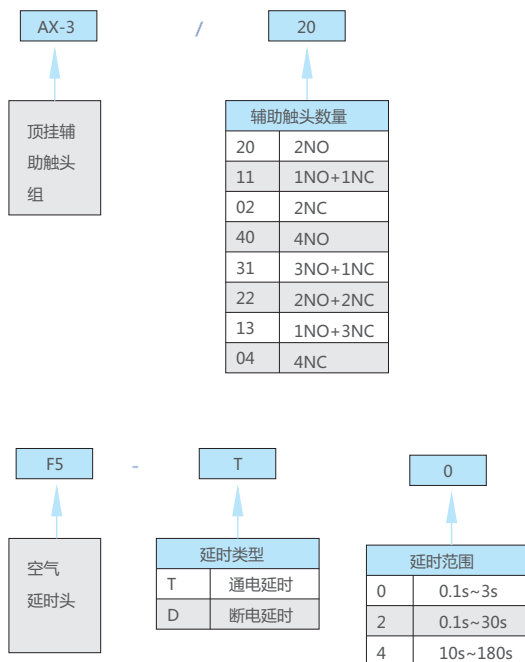

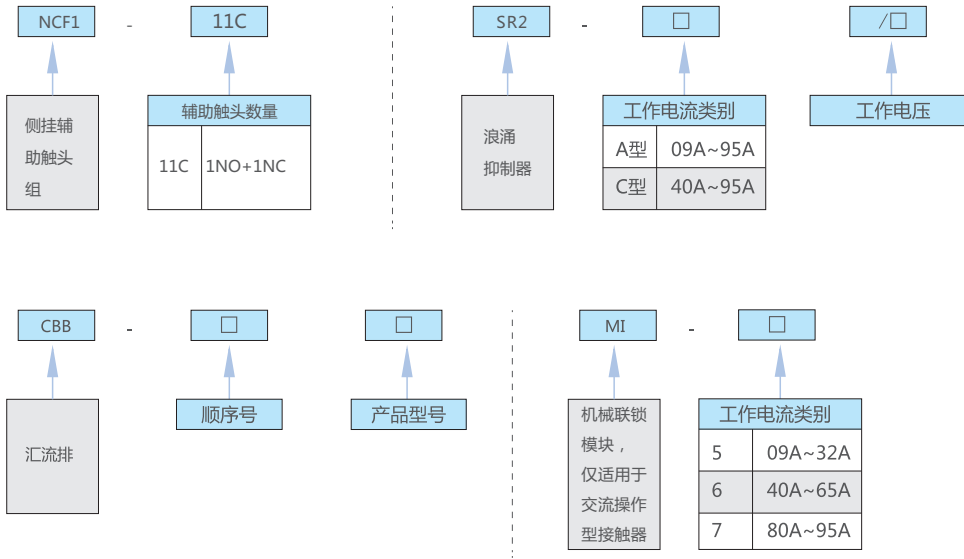

附件型号及含义：



注：NC7产品9A~95A机械联锁模块可直接备注购买

## 3 正常工作条件和安装条件

- 3.1 周围空气温度为：-5℃~+40℃，24小时内其平均值不超过+35℃。
- 3.2 大气条件：最高温度为+40℃时，空气的相对湿度不超过50%，在较低温度下可以允许有较高的相对湿度，例如20℃时达90%。对由于温度变化偶尔产生的凝露应采取特殊的措施。
- 3.3 海拔高度：不超过2000m。
- 3.4 污染等级：3级。
- 3.5 安装类别：Ⅲ类。
- 3.6 安装条件：安装面与垂直面倾斜度不大于±5°。
- 3.7 冲击振动：产品应安装和使用在无显著摇动、冲击和振动的地方。

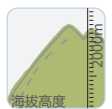

## 4 快速选型表

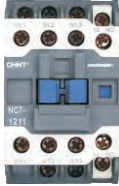
电流规格	9A	12A	18A	22A	25A	32A	38A	
								
本体自带 辅助触头数	1NO+1NC	NC7-0911	NC7-1211	NC7-1811	NC7-2211	NC7-2511	NC7-3211	NC7-3811
IEC/EN 60947-4-1		kW A	kW A	kW A	kW A	kW A	kW A	kW A
约定自由空气发热电流(A) (AC-1)		20	20	32	32	40	50	50
额定工作 电流及功 率	380V/400V(AC-3)	4 9	5.5 12	7.5 18	11 22	11 25	15 32	18.5 38
	380V/400V(AC-4)	1.5 3.5	2.2 5	3 7.7	3 7.7	4 8.5	5.5 12	5.5 12
	660V/690V(AC-3)	5.5 6.6	7.5 8.9	10 12	11 14	15 18	18.5 22	18.5 22
	660V/690V(AC-4)	1.1 1.5	1.5 2	3.7 3.8	3.7 3.8	4 4.4	5.5 7.5	5.5 7.5
	220V/230V(AC-3)	2.2 9	3 12	4 18	5.5 22	5.5 25	7.5 32	9.0 38

可加配附件



侧挂辅助触头



顶挂辅助触头



空气延时头



机械联锁模块

更多附件参数请查看快速选型表



浪涌抑制器



热过载继电器



电子式过载继电器

电流规格		40A	50A	65A	80A	95A					
											
本体自带 辅助触头数	1常开1常闭 辅助触头 1NO+1NC	NC7-4011	NC7-5011	NC7-6511	NC7-8011	NC7-9511					
IEC/EN 60947-4-1		kW A	kW A	kW A	kW A	kW A					
约定自由空气发热电流(A)		60		80	80		125	125			
额定工作 电流及功率	380V/400V(AC-3)	18.5	40	22	50	30	65	37	80	45	95
	380V/400V(AC-4)	7.5	18.5	11	24	15	28	18.5	37	22	44
	660V/690V(AC-3)	30	34	37	39	37	42	45	49	45	49
	660V/690V(AC-4)	7.5	9	11	12	11	14	15	17.3	18.5	21.3
	220V/380V(AC-3)	11	40	15	50	18.5	65	22	80	25	95

可加配附件



侧挂辅助触头



顶挂辅助触头



空气延时头



机械联锁模块

更多附件参数请查看快速选型表



SR2-C



热过载继电器



电子式过载继电器

# 控制电器

电流规格		115A	150A	170A
				
本体自带 辅助触头数		NC7-115	NC7-150	NC7-170
IEC/EN 60947-4-1		kW    A	kW    A	kW    A
约定自由空气发热电流(A)		200	200	275
额定工作 电流及功率	380V/400V(AC-3)	55    115	75    150	90    170
	380V/400V(AC-4)	55    115	75    150	90    150
	660V/690V(AC-3)	80    86	100   107	110   118
	660V/690V(AC-4)	80    86	100   107	110   107

可加配附件

更多附件参数请查看第8页~第9页



顶挂辅助触头



空气延时头



侧挂辅助触头



热过载继电器



电子式过载继电器



机械联锁模块

电流规格		205A	250A	300A
				
本体不带辅助触头可加装两个顶挂辅助	加2个AX-3/22 即四常开四常闭 4NO+4NC 其他形式	NC7-205 备注说明	NC7-250 备注说明	NC7-300 备注说明
IEC/EN 60947-4-1		kW    A	kW    A	kW    A
约定自由空气发热电流(A)		275	315	380
额定工作 电流及功 率	380V/400V(AC-3)	110    205	132    250	160    300
	380V/400V(AC-4)	110    205	132    250	160    300
	660V/690V(AC-3)	129    137	160    170	220    235
	660V/690V(AC-4)	129    137	160    170	220    235

可加配附件



顶挂辅助触头



空气延时头



机械联锁模块

更多附件参数请查看第8页~第9页





热过载继电器



电子式过载继电器

# 控制电器

电流规格		410A	475A	620A
				
本体不带辅助触头可加装两个顶挂辅助	加2个AX-3/22 即四常开四常闭 4NO+4NC 其他形式	NC7-410 备注说明	NC7-475 备注说明	NC7-620 备注说明
IEC/EN 60947-4-1		kW    A	kW    A	kW    A
约定自由空气发热电流(A)		450	630	800
额定工作 电流及功 率	380V/400V(AC-3)	200    410	265    475	335    620
	380V/400V(AC-4)	200    410	265    475	335    620
	660V/690V(AC-3)	280    303	335    353	450    462
	660V/690V(AC-4)	280    303	335    353	450    462

可加配附件

更多附件参数请查看第8页~第9页



顶挂辅助触头



空气延时头



机械联锁模块



热过载继电器



电子式过载继电器

可  
加  
装  
模  
块  
化  
附  
件



AX-3  
辅助触头

辅助触头数量

4NO AX-3/40

3NO+1NC AX-3/31

2NO+2NC AX-3/22

1NO+3NC AX-3/13

4NC AX-3/04

2NO AX-3/20

1NO+1NC AX-3/11

2NC AX-3/02

可用于全系列产品



F5  
1NO+1NC  
空气延时头

通电延时时间(s)

0.1~3 F5-T0

0.1~30 F5-T2

10~180 F5-T4

0.1~3 F5-D0

断电延时时间(s)

0.1~30 F5-D2

10~180 F5-D4

可用于全系列产品



NCF1-11C  
侧挂辅助触头

辅助触头数量

1NO+1NC

NCF1-11C

可用于170A及以下产品



SR2-C  
浪涌抑制器

抑制电压范围

AC/DC: 24V~48V SR2-C 24V~48V

AC/DC: 100V~250V SR2-C 100V~250V

AC/DC: 380V~440V SR2-C 380V~440V

可用于09A~95A产品





NR2  
热继电器

NR2-25	9A~32A
NR2-36	32A、38A
NR2-93	40A~95A
NR2-150	115A~150A
NR2-200	115A~170A
NR2-630	205A~620A



NRE8  
电子式过载继电器

NRE8-25	9A~32A
NRE8-40	40A
NRE8-100	40A~95A

可  
加  
装  
模  
块  
化  
附  
件

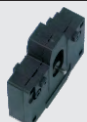

NC7-09~95  
机械联锁模块

205A以上  
产品机械联  
锁机构代号



NC7-205~620  
机械联锁



NC7-115~170  
机械联锁

		MI-5	适用于9A~38A
		MI-6	适用于40A~65A
		MI-7	适用于80A~95A
水平安装	NJLs-GG	NC7-205两台组合	
	NJLs-HH	NC7-250~300任意两台组合	
	NJLs-KK	NC7-410~475任意两台组合	
	NJLs-LL	NC7-620两台组合	
垂直安装	NJLc-GG	NC7-205两台组合	
	NJLc-GH	NC7-205和NC7-250~300任1台组合	
	NJLc-GK	NC7-205和NC7-410~475任1台组合	
	NJLc-GL	NC7-205和NC7-620组合	
	NJLc-HH	NC7-250~300任意两台组合	
	NJLc-HK	NC7-250~300任1台和NC7-410~475任1台组合	
	NJLc-HL	NC7-250~300任1台和NC7-620组合	
	NJLc-KK	NC7-410~475任意两台组合	
	NJLc-KL	NC7-410~475任1台和NC7-620组合	
NJLc-LL	NC7-620两台组合		
NCL7	适用于115A~170A		

5 主要参数及技术性能

5.1 NC7产品的主要参数及技术性能指标。

型号		NC7-09	NC7-12	NC7-18	NC7-22	NC7-25	NC7-32	NC7-38	NC7-40	NC7-50	NC7-65	NC7-80	NC7-95													
额定工作 电流(A)	380V/400V	AC-1	20	20	32	32	40	50	50	60	80	80	110	110												
		AC-3	9	12	18	22	25	32	38	40	50	65	80	95												
	660V/690V	AC-4	3.5	5	7.7	7.7	8.5	12	12	18.5	24	28	37	44												
		AC-3	6.6	8.9	12	14	18	22	22	34	39	42	49	49												
	AC-4	1.5	2	3.8	3.8	4.4	7.5	7.5	9	12	14	17.3	21.3													
约定自由空气发热电流(A)		20	20	32	32	40	50	50	60	80	80	120	120													
额定绝缘电压(V)		690	690	690	690	690	690	690	690	690	690	690	690													
额定冲击耐受电压(kV)		6	6	6	6	6	6	6	8	8	8	8	8													
额定接通能力		接通电流: 10xIe(AC-3)或12xIe(AC-4)																								
额定分断能力		接通分断电流: 8xIe(AC-3)或10xIe(AC-4)																								
短时耐受电流(10s)		72	96	144	176	200	256	304	320	400	520	640	760													
可控三相鼠笼 电动机功率(AC-3)kW	220V/230V	2.2	3	4	5.5	5.5	7.5	9	11	15	18.5	22	25													
	380V/400V	4	5.5	7.5	11	11	15	18.5	18.5	22	30	37	45													
	660V/690V	5.5	7.5	10	11	15	18.5	18.5	30	37	37	45	45													
断续周期工作制下 电动机功率(AC-4)kW	380V/400V	1.5	2.2	3	3	4	5.5	5.5	7.5	11	15	18.5	22													
	600V/690V	1.1	1.5	3.7	3.7	4	5.5	5.5	7.5	11	11	15	18.5													
操作 频率 (次/h)	电寿命	AC-3	1200	1200	1200	1200	1200	600	600	600	600	600	600													
	AC-4	300	300	300	300	300	300	300	300	300	300	120	120													
机械寿命		3600	3600	3600	3600	3600	3600	3600	3600	3600	3600	3600	3600													
电寿命 (万次)	AC-3	100	100	100	100	100	80	80	80	60	60	60	60													
	AC-4	20	20	20	20	20	20	20	15	15	15	10	10													
机械寿命(万次)		1000	1000	1000	1000	1000	800	800	800	800	800	600	600													
配用熔断器型号		gG20	gG20	gG32	gG32	gG40	gG50	gG50	gG63	gG80	gG80	gG100	gG125													
冷压 端子	非预制端头软线 有预制端头软线 非预制端头硬线	根	1	2	1	2	1	2	1	2	1	2	1	2	1	2	1	2	1	2	1	2	1	2		
		mm <sup>2</sup>	1/2.5	1/2.5	1/2.5	1/2.5	1.5/4	1.5/4	1.5/4	1.5/4	1.5/4	1.5/4	2.5/6	2.5/6	2.5/6	2.5/6	6/25	4/10	6/25	4/10	6/25	4/10	10/35	6/16	10/35	6/16
		1/4	1/2.5	1/4	1/2.5	1.5/6	1.5/4	1.5/6	1.5/4	1.5/10	1.5/6	2.5/10	2.5/6	2.5/10	2.5/6	6/25	4/10	6/25	4/10	6/25	4/10	10/35	6/16	10/35	6/16	
	1/4	1/4	1/4	1/4	1.5/6	1.5/6	1.5/6	1.5/6	1.5/6	1.5/6	2.5/10	2.5/10	2.5/10	2.5/10	6/25	4/10	6/25	4/10	6/25	4/10	10/35	6/16	10/35	6/16		
接线端子螺钉大小		M3.5	M3.5	M3.5	M3.5	M4	M4	M4	M8	M8	M8	M10	M10													
及拧紧力矩(N·m)		0.8	0.8	0.8	0.8	1.2	1.2	1.2	4	4	4	6	6													
交流 线圈 功率	50Hz	吸合(VA)	70	70	70	70	110	110	110	300	300	300	300													
		保持(VA)	9.0	9.0	9.5	9.5	14	19.0	19.0	57	57	57	57													
	功率(W)	1.8~2.7	1.8~2.7	3~4	3~4	3~4	3~4	3~4	3~4	6~10	6~10	6~10	6~10													
动作范围		吸合电压为: 85%Us~110%Us; 释放电压为: 20%Us~75%Us																								
辅助触头基本参数		AC-15: 0.95A 380V/400V DC-13: 0.15A 220V/250V Ith: 10A																								

5.2 NC7交流接触器95A及以下产品线圈额定控制电源电压Us及代号。

线圈电压Us(V)	24	36	42	48	110	127	220	230	240	380	400	415	440	480	500	600	660
50Hz	B5	C5	D5	E5	F5	G5	M5	P5	U5	Q5	V5	N5	R5	T5	S5	X5	Y5
60Hz	B6	C6	D6	E6	F6	G6	M6	P6	U6	Q6	V6	N6	R6	T6	S6	X6	Y6
50/60Hz	B7	C7	D7	E7	F7	G7	M7	P7	U7	Q7	V7	N7	R7	T7	S7	X7	Y7

# 控制电器

型号		NC7-115	NC7-150	NC7-170	NC7-205	NC7-250	NC7-300	NC7-410	NC7-475	NC7-620	
额定工作电流(A)	380V/400V	AC-3	115	150	170	205	250	300	410	475	620
		AC-4	115	150	150	205	250	300	410	475	620
	660V/690V	AC-3	86	107	118	137	170	235	303	353	462
		AC-4	86	107	107	137	170	235	303	353	462
约定自由空气发热电流(A)		200	200	275	275	315	380	450	630	800	
额定绝缘电压(V)		1000	1000	1000	1000	1000	1000	1000	1000	1000	
额定冲击耐受电压(kV)		8	8	8	8	8	8	8	8	8	
额定接通能力		接通电流: 10xIe(AC-3)或12xIe(AC-4)									
额定分断能力		接通分断电流: 8xIe(AC-3)或10xIe(AC-4)									
短时耐受电流(10s)		920	1200	1360	1640	2000	2400	3280	3800	4960	
可控三相鼠笼电动机功率(AC-3)kW	380V/400V	55	75	90	110	132	160	200	265	335	
	660V/690V	80	100	110	129	160	220	280	335	450	
断续周期工作制下电动机功率(AC-4)kW	380V/400V	55	75	90	110	132	160	200	265	335	
	600V/690V	80	100	110	129	160	220	280	335	450	
操作频率(次/h)	电寿命	AC-3	1200	1200	600	600	600	600	600	600	600
		AC-4	120	120	120	60	60	60	60	60	60
机械寿命		1200	1200	600	600	600	600	600	600	600	
电寿命(万次)	AC-3	80	80	60	60	60	60	60	60	60	
	AC-4	2	2	1	1	1	1	1	0.6	0.6	
机械寿命(万次)		600	600	600	600	600	600	600	600	600	
配用熔断器型号		gG225	gG225	gG315	RT16-2	RT16-2	RT16-3	RT16-3	RT16-4	RT16-4	
交流线圈功率	50Hz	吸合(VA)	115	150	170						
			660	660	660						
		保持(VA)	91.2	91.2	91.2						
		功率(W)	10-15	10-15	10-15						
动作范围		吸合电压为: 85%Us~110%Us; 释放电压为: 20%Us~75%Us (250~620: 释放电压为 10%Us~75%Us)									
辅助触头基本参数		AC-15: 0.95A 380V/400V DC-13: 0.15A 220/250V Ith: 10A									

型号	NC7-115	NC7-150	NC7-170	NC7-205
根数	2	2	2	1
电缆(mm <sup>2</sup> )	10~95	10~95	10~95	95~150
铜排(mm)	-	-	-	-
连接螺栓	M10	M10	M10	M10
拧紧力矩(N·m)	10	10	10	10













型号	NC7-250	NC7-300	NC7-410	NC7-475	NC7-620
根数	1	1	1(2)	2	2
电缆(mm <sup>2</sup> )	120~185	185~240	240(150)	150~185	185~240
铜排(mm)	-	-	30X5	40X5	50X5
连接螺栓	M10	M10	M10	M10	M12
拧紧力矩(N·m)	10	10	10	10	14

5.3 NC7交流接触器115A~620A产品线圈额定控制电源电压Us及代号。

线圈代号 接触器型号	控制电压(V)				功率 VA		简图
	110	127	220	380	起动	保持	
NC7-115~170	F5	G5	M5	Q5	660	91.2	
NC7-205	FG110	FG127	FG220	FG380	966	91.2	
NC7-250	FI110	FI127	FI220	FI380	1500	34.2	
NC7-300	FI110	FI127	FI220	FI380	1500	34.2	
NC7-410	FJ110	FJ127	FJ220	FJ380	1500	34.2	
NC7-475	FK110	FK127	FK220	FK380	1500	34.2	
NC7-620	FL110	FL127	FL220	FL380	1700	34.2	

注: NC7-250及以上为双绕组产品。

## 6 派生产品

派生产品	接触器	辅助模块	简图
可逆接触器		+ 	→ 
延时接触器		+ 	→ 
星三角 起动器		+ 	→ 
磁力起动器		+ 	→ 

## 7 外形及安装尺寸

NC7-09~38

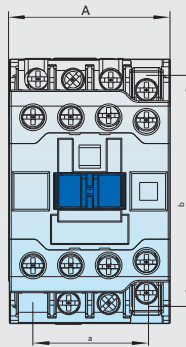
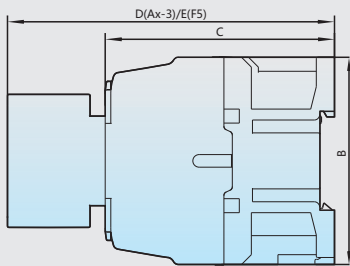

NC7-40~95

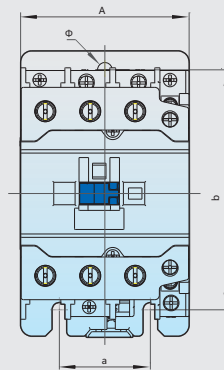
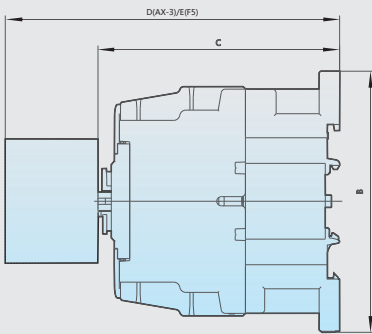

NC7-115~170

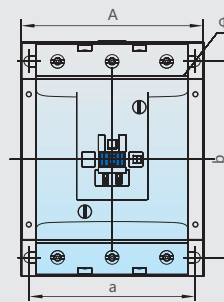
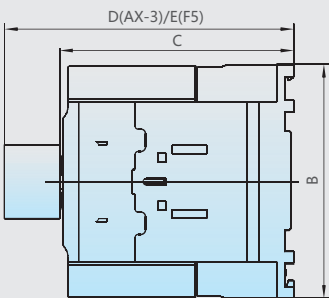

NC7-205~300

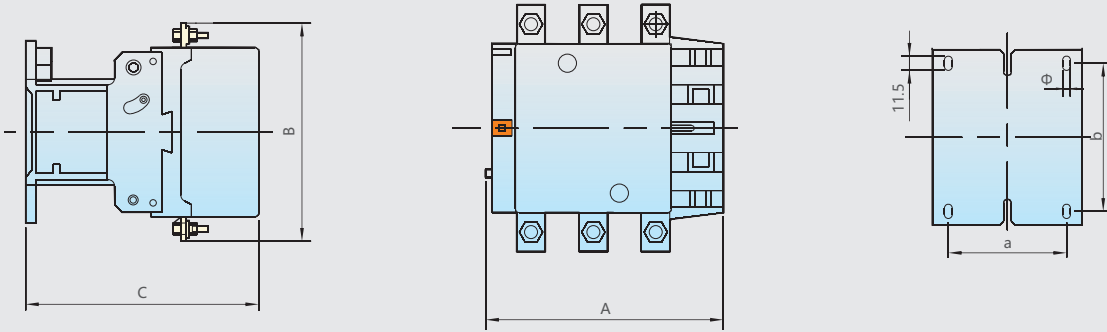

NC7-410~475

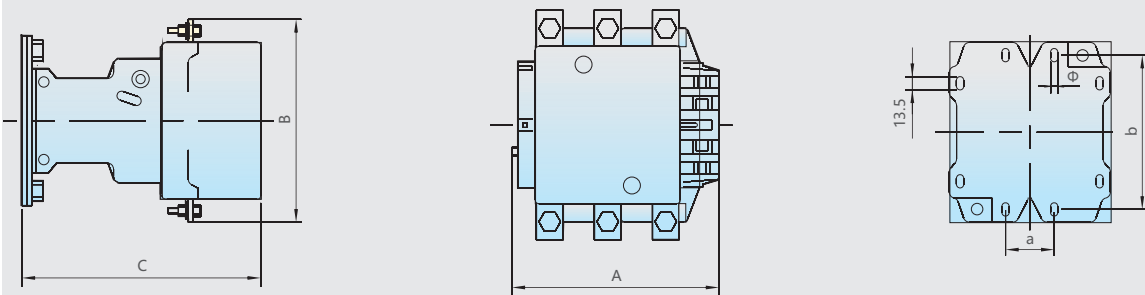

NC7-620

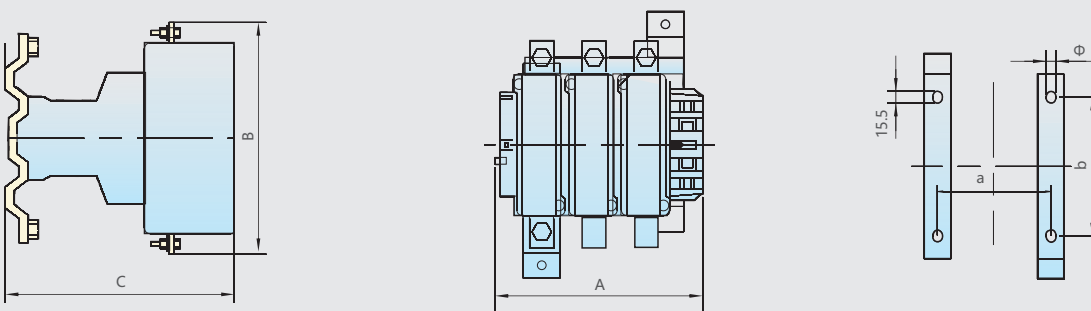



型号规格	Amax	Bmax	Cmax	Dmax	Emax	a	b	φ
NC7-09~12	47	76	88	124.5	144.5	34/35	50/60/62	4.5
NC7-18~22	47	76	91	129.5	149.5	34/35	50/60/62	4.5
NC7-25	57	88	100	136.5	156.5	40	50/60/75	4.5
NC7-32~38	57	88	105	140.5	160.5	40	50/60/75	4.5
NC7-40~65	77	129	119	157.5	177.5	40.5	107	6.5
NC7-80~95	85	129	127	165.5	185.5	40.5	107	6.5
NC7-115~170	122	157	158	192.5	212.5	96~110	130	7
NC7-205	171	197	186			80	110~120	6.5
NC7-250	202	203	215			96	110~120	6.5
NC7-300	213	206	220			96	110~120	6.5
NC7-410	213	206	221			80	170~180	8.5
NC7-475	233	238	233			80	170~180	8.5
NC7-620	309	304	256			180	180~190	10.5

mm

## 8 在照明电路中的应用



产品规格			09、12	18	25	32、38	40	50、65	80、100
灯的技术参数 (220V/240V)			最大允许控制的数量						
W	A	μF							
<b>白炽灯</b>									
60	0.27	-	59	77	92	129	163	207	296
75	0.34	-	47	61	73	103	129	164	235
100	0.45	-	35	46	55	77	97	124	177
150	0.68	-	23	30	36	51	64	82	117
200	0.91	-	17	23	27	38	48	62	88
300	1.40	-	11	15	18	25	31	40	57
500	2.30	-	7	8	11	15	19	24	34
750	3.40	-	4	6	7	10	13	16	23
1000	4.60	-	3	4	5	7	9	12	17
<b>单管荧光灯(带起动器、无补偿)</b>									
20	0.39	-	41	53	66	89	112	143	205
40	0.45	-	35	46	57	77	97	124	177
65	0.70	-	22	30	37	50	62	80	114
80	0.80	-	20	26	32	43	55	70	100
110	1.15	-	12	15	20	26	35	46	66
<b>单管荧光灯(带起动器、并联补偿)</b>									
20	0.18	5	94	105	155	215	233	335	530
40	0.26	5	65	75	107	150	160	230	365
65	0.42	7	40	45	66	92	100	142	225
80	0.52	7	32	36	53	74	80	115	180
100	0.6	16	26	29	43	59	64	92	145
110	0.70	18	24	27	40	55	59	85	135
<b>双管荧光灯(带起动器、无补偿)</b>									
2×20	2×0.22	-	36	46	58	78	100	126	180
2×40	2×0.41	-	18	24	30	42	52	68	96
2×65	2×0.67	-	10	14	18	26	32	40	58
2×80	2×0.82	-	8	12	14	20	26	34	48
2×110	2×1.10	-	6	8	10	14	18	24	36

续上表

产品规格			09、12	18	25	32、38	40	50、65	80、100
灯的技术参数 (220V/240V)			最大允许控制的数量						
W	A	μF							
<b>双管荧光灯(带起动机、串联补偿)</b>									
2×20	2×0.13	-	60	80	100	134	168	214	306
2×40	2×0.24	-	32	42	54	72	90	116	166
2×65	2×0.39	-	20	26	32	44	56	70	102
2×80	2×0.48	-	16	20	26	36	44	58	82
2×110	2×0.65	-	12	16	20	26	32	42	60
<b>单管荧光灯(不带起动机、无补偿)</b>									
20	0.43	-	37	48	60	97	102	130	186
40	0.55	-	29	38	47	63	80	101	145
65	0.80	-	20	26	32	43	55	70	100
80	0.95	-	16	22	27	36	46	58	84
110	0.40	-	11	15	18	25	31	40	57
<b>单管荧光灯(不带起动机、并联补偿)</b>									
20	0.19	5	84	110	136	184	231	294	421
40	0.29	5	55	72	89	101	151	193	275
65	0.46	7	34	45	56	76	95	121	173
80	0.57	7	28	36	45	61	77	98	140
110	0.79	16	20	26	32	44	55	70	101
<b>双管荧光灯(不带起动机、无补偿)</b>									
2×20	2×0.25	-	32	42	52	70	88	112	160
2×40	2×0.47	-	16	22	26	36	46	58	84
2×65	2×0.76	-	10	12	16	22	28	36	52
2×80	2×0.93	-	8	10	12	18	22	30	42
2×110	2×1.30	-	6	8	10	12	16	20	30
<b>双管荧光灯(不带起动机、串联补偿)</b>									
2×20	2×0.15	-	56	74	92	124	156	200	234
2×40	2×0.26	-	30	40	50	66	84	106	152
2×65	2×0.43	-	18	24	30	40	50	64	92
2×80	2×0.53	-	14	18	24	32	40	52	74
2×110	2×0.72	-	10	14	18	24	30	38	54
<b>低压钠蒸汽灯(无补偿)</b>									
35	1.2	-	10	12	15	21	27	35	50
55	1.6	-	7	9	11	16	20	26	37
90	2.4	-	5	6	7	10	13	17	25
135	3.1	-	3	4	6	8	10	13	19
150	3.2	-	3	4	5	8	10	13	18
180	3.3	-	3	4	5	7	10	12	18
200	3.4	-	3	4	5	7	9	12	17
<b>低压钠蒸汽灯(并联补偿)</b>									
35	0.3	17	40	50	63	86	110	140	200
55	0.4	17	30	37	47	65	82	105	150
90	0.6	25	-	25	31	43	55	70	100
135	0.9	36	-	-	21	28	36	46	66
150	1.0	36	-	-	19	26	33	42	60
180	1.2	36	-	-	15	21	27	35	50
200	1.3	36	-	-	14	20	25	32	46



续上表

产品规格			09、12	18	25	32、38	40	50、65	80、100
灯的技术参数 (220V/240V)			最大允许控制的数量						
W	A	μF							
<b>高压钠蒸汽灯(无补偿)</b>									
150	1.9	-	6	7	10	13	17	22	31
250	3.2	-	3	4	5	8	10	13	18
400	5.0	-	2	3	3	5	6	8	12
700	8.8	-	-	2	2	2	3	4	6
1000	12.4	-	-	1	1	2	2	3	4
<b>高压钠蒸汽灯(并联补偿)</b>									
150	0.84	20	-	17	22	30	39	50	71
250	1.4	32	-	-	13	18	23	30	42
400	2.2	48	-	-	8	11	15	19	27
700	3.6	96	-	-	-	6	8	10	15
1000	5.5	120	-	-	-	-	6	7	10
<b>高压水银灯(无补偿)</b>									
50	0.54	-	22	27	35	48	64	77	111
80	0.81	-	14	18	23	32	40	51	74
125	1.20	-	9	12	15	21	27	34	49
250	2.30	-	5	6	8	11	14	17	26
400	4.10	-	2	3	4	6	8	10	14
700	6.80	-	1	2	2	3	4	6	8
1000	9.90	-	1	1	1	2	3	4	6
<b>高压水银灯(并联补偿)</b>									
50	0.30	10	40	50	63	86	110	140	200
80	0.45	10	26	33	42	57	73	93	133
125	0.67	10	17	22	28	38	49	62	89
250	1.3	18	9	11	14	20	25	32	46
400	2.3	25	-	6	8	11	14	18	26
700	3.8	40	-	-	5	6	8	11	15
1000	5.5	60	-	-	3	4	6	7	10

## 9 订货须知

订货时必须指出：

- 9.1 接触器完整的名称、型号；
- 9.2 线圈的额定控制电源电压和频率或规格代号
- 9.3 产品如需订购AX-3辅助触头组、F5空气延时头，应另外注明；205A及以上产品如不指明辅助触头组数量和组合情况，则不予加装；
- 9.4 NC7 115A~170A产品出厂时本体不带防尘盖，用户需要时请另外注明。
- 9.5 订货数量。
- 9.6 38A及以下派生N常规产品三极为可逆接线方式，特殊接线方式须注明。
- 9.7 205A及以上派生NS常规产品三极为可逆接线方式，特殊接线方式须注明。
- 9.8 订货示例：NC7-0910交流接触器 线圈电压220V 50Hz 10台 AX-3/22 5只  
NC7-300交流接触器 线圈电压220V 50Hz 10台 加装AX-3/22 10只。

需要订购的机械联锁机构	订购时书写示例
NC7-205与NC7-620组合的机械联锁 垂直安装 机械联锁机构 30付	NJLC-GL 30付
NC7-250两台组合的机械联锁 水平安装 机械联锁机构 30付	NJLC-HH 30付

## X-ON Electronics

Largest Supplier of Electrical and Electronic Components

*Click to view similar products for [Contactors - Electromechanical category](#):*

*Click to view products by [CHINT manufacturer](#):*

Other Similar products are found below :

[686-120111](#) [70-901](#) [70-914](#) [MB-3D-6](#) [MC-22A/4-AC120V](#) [8-1616943-9](#) [8-1672124-5](#) [A701U](#) [AVR743D](#) [B6-40-00-84](#) [B7-40-00-84](#)  
[1616017-5](#) [HP-11D-24](#) [P25-E5019-1](#) [P40P47D13P1-24-01](#) [CA7-72-00-24Z](#) [90-162](#) [9-1393132-2](#) [2NC4F0222](#) [ACC338UMM20](#)  
[AF80-30-11-13](#) [SZ-B1](#) [3GC2H0M22](#) [3NC0T0A22](#) [3NC1Q0A22](#) [42AF35AG](#) [42AF35AH](#) [42CF35AE](#) [42CF35AL](#) [42FE35AFR](#)  
[45CG10AFA](#) [45CG10AJA](#) [45CG10EJA](#) [45CG20AF](#) [45CG20AL](#) [45CG20EF](#) [45CG20EG](#) [45CG20EL](#) [45DG10AFA](#) [45DG10AGA](#)  
[45DG10AJA](#) [45DG10ALA](#) [45DG10ELA](#) [45DG20AG](#) [45DG20AL](#) [45EG10AFA](#) [45EG10AJA](#) [45EG10ALA](#) [45EG20AL](#) [45FG10AFA](#)