



GD97=: =75H=CB : CF 5DDFCJ 5@

8YgW] dh] cb GHD fl. 25L

7CBB HMD9 1. 25aa KH6 GAH 7CBB

7I GHCA9F

=ggi Yf

9b[] bYYf

5ddf cj Yf

	/	
--	---	--

(\$ & 6+% ! &

<hhd. ##kkk" Wl i bXU' W@a



H=H@. . . %' & AA . D=H7< . ; <8 . 7CBB97HCF . 8CI 6@9 . FCK . HMD9

D5FH Bc" . . <7! ; <8 ! . } } }

F9@95G9 85H9. &\$&\$#, #&\$	F9J=G=CB. 5	97B Bc" .	D5; 9. ' . C. %
-----------------------------	-------------	-----------	-----------------

% Gwdy

... H\Y WbbYbhg' cZ' gdYW\Z] W]h] cbg' Zcf ' % & ' gYf] Yg' WbbYWcf ' ghf] d'] bWi X] b[
 ... df cX] W] dYf Zcf aUbWz' hYgh' aYh\cXg' UbX] bgdYW] cb' fYei] fYaYbhg
 . . . % & .

& . 5DD@=756@9 G#B85F8G

... &' % ; 6#H&(&% H\gh] b[' aYh\cX Zcf ' 9bj] f cbaYbhU ' cZ' 9' YW] W] 7cbbYWcf g' 7 Ugg' %
 ; YbYfU ' Df] bWYd' Yg
 ; 6#H&(&%
 ... &' & ; 6#H&(& H\gh] b[' aYh\cX Zcf ' 9bj] f cbaYbhU ' cZ' 9' YW]f] W] ' 7cbbYWcf g
 ; 6#H&(&
 ... &' ' ; 6#H&(&(. H\gh] b[' aYh\cX Zcf ' 9bj] f cbaYbhU ' cZ' 9' YW]f] W] ' 7cbbYWcf g
 ; 6#H&(&(.
 ... &' (; 6#H) \$-) H\gh] b[' df cW]f f Y#aYh\cX Zcf ' WadcbYbhg' cZ' Y YW]f] WYei] daYbh
 ; 6#H) \$-)

I G9 7CB8=H=CB

... "% 5aV] Ybh' hYadYf Uhi f Y FUb] Y ! & ,)
 ! & Z)
 ... " & 5dd] W] Y' K] f Y' G] nYg . 5K ; ' &* ' \$
 5K ; ' &* ' \$
 ... " " 5dd] W] Y' D7' VcUf X h\] W . bYgg \$" * ` " &aa
 D7 \$" * ` " &aa

(5ddYUf UbW' UbX 8] aYbg] cb

... (" % 5ddYUf UbW' . Df cX] W] gi f ZUW' k] h\ci h' XYZYW] X] fh WUW UbX aYWUb] W]
 XLaU] Yz' 7cbbUW] k] h\ci h' fi gh' d' Uh] b[' bch' cl] XYg' UbX bch' dYY YX

 ... (" & 8] aYbg] cb . 5W]f X] b[' hc' Xf Uk] b[g

 ... (" " 9] WUb] YU' Y . 9] WUb] YU' Y k] h\ ' gLaY gdYW\Z] W]h] cb' df cX] W]g"



1.25MM PITCH GHD 7CBB97HCF 8CI 6@9 FCK HMD9

D5FH Bc" . <7! ; <8! } } }

F9@95C9 85FD. &&&# , #&&

F9J=G=CB. 5

97B Bc" .

D5; 9. (C %

) ALHyf]U

Bc"	D#B	HndY	ALHyf]U	:]b]g\	9l d U]b
)"%	HYfa]bU	7cbhUM	Phosphor bronze锡 青磷铜厚0.12mm	H]b d Uh]b[. ') μ m 镀锡: 3~5 μ m	ROHS
)"&	<ci g]b[D Ugh]W	Nylon66 UL94V-0	Color: Nature 颜色: 本色	
5.3	Wafer 卧贴针座	D Ugh]W	PA46 UL94V-0	Color: Nature 颜色: 本色	
		7cbhUM	Brass 黄铜 厚 0.30mm	Tin plating:3~5 μ m 镀锡: 3~5 μ m	
		Gc`Xyf`hUV	Brass 黄铜 厚 0.25mm	Tin plating:3~5 μ m 镀锡3~5 μ m	
5.4	Wafer 立贴针座	D Ugh]W	LCP UL94V-0	Color: Nature 颜色: 本色	
		7cbhUM	Brass 黄铜 厚 0.30mm	Tin plating:3~5 μ m 镀锡: 3~5 μ m	
		Gc`Xyf`hUV	Brass 黄铜 厚 0.25mm	Tin plating:3~5 μ m 镀锡3~5 μ m	



TITLE: 1.25MM PITCH GHD CONNECTOR DOUBLE ROW TYPE

PART No. : XD-GHD - ****

RELEASE DATE: 2020/8/20

REVISION: A

ECN No. :

PAGE: 5 OF 14

6、Electrical Performance

电气性能

No. 序号	Item 项目	Test mode 试验方法	Requirement 技术要求
6.1	Current Rated 额定电流		1.25A AC DC
6.2	Voltage Rated 额定电压		50V AC DC
6.3	Contact Resistance 接触电阻	<p>A maximum voltage of 20m V and maximum current of 100mA are applied to the Mate connector</p> <p>组合状态下的连接器，两端施以最大测试电压20 mV以及最大测试电流100 mA</p> <p>Does not include wire resistance</p> <p>不包含电线阻抗</p>	<p>Initial value less than 20m Ω</p> <p>初始值 ≤ 50 Ω</p>
6.4	Withstand voltage 耐电压	<p>Apply 500V AC(rms) for 1 minute and the leakage current shall not exceed 0.5mA to the adjacent terminal and ground of the mate connectors</p> <p>组合状态下的连接器，相邻两导体末端各施以电压500V AC（有效值）时间1分钟，且漏电电流必须小于0.5mA（毫安培）</p>	<p>No breakdown or flashover</p> <p>无击穿或者产生火花</p>
6.5	Insulation Resistance 绝缘电阻	<p>Apply 500V DC(rms) for 1 minute between adjacent contacts to measure the insulation resistance</p> <p>相邻两接触导体，一分钟内施以500V DC电压，测量期间的绝缘阻抗值</p>	<p>More than100 M Ω</p> <p>≥100M Ω</p>



TITLE: 1.25MM PITCH GHD CONNECTOR DOUBLE ROW TYPE

PART No. : XD-GHD - ****

RELEASE DATE: 2020/8/20

REVISION: A

ECN No. :

PAGE: 6 OF 14

7、 Mechanical Performance:

机械性能

No. 序号	Item 项目	Test mode 试验方法	Requirement 技术要求
7.1	Terminal crimping Wire strength 端子压接导线强度	Terminal crimping wire Axial per minute to 25 ±3mm rate of the pullout force 端子所压接电线，以每分钟25 ±3mm 速之轴向拔出力	AWG#26wire AWG#26导线 More than 20N ≥20N
			AWG#28wire AWG#28导线 More than 13N ≥13N
			AWG#30wire AWG#30导线 More than 8N ≥8N
7.2	Fixed terminals And hole seat 端子与孔座固定力	The terminal and the hole seat at a react per minute to 25 ±3mm along the write direction are pulled out from the hole in the seat capacity 端子与孔座配合以每分钟 25±3mm 的速度沿导线方向, 将端子从孔座中拔出的力	Percontact 单一接触点 More than 4N ≥4N
7.3	Single contact insertion force 单接触插入力	The housing together with the terminal ends with wafer matched at a rate per minute to 25±3mm inserting force test 孔座连同端子与针座两端互配以每分钟 25 ±3mm 的速度作插入力测试	Less than 3N≤3N
7.4	Single contact Withdrawal force 单接触拔出力	The housing together with the terminal ends with wafer matched at a rate per minute to 25±3mm inserting force test 孔座连同端子与针座两端互配以每分钟 25 ±3mm 的速度作拔出力测试	More than 0.3N ≥0.3N
7.5	Pin Retention Force pin Pin针固定力	Exerts a force on the pin end at a rate per Minute 25±3mm until the needle exit Seat pull-out force 在脚端施加力以每分钟 25±3mm 的速度直到针退出针座的拔出力	Percontact 单一接触点 More than 7N ≥7N



TITLE: 1.25MM PITCH GHD CONNECTOR DOUBLE ROW TYPE

PART No. : XD-GHD - ****

RELEASE DATE: 2020/8/20

REVISION: A

ECN No. :

PAGE: 7 OF 14

7、 Mechanical Performance:

机械性能

No. 序号	Item 项目	Test mode 试验方法	Requirement 技术要求
7.6	Durability 耐久性	<p>Mate connectors up 30 cycles at a Maximum rate of 10 cycles per minute prior to environmental test</p> <p>组合状态下的连接器且未经环境测试每分钟内进行10次嵌入与拔出，连续30次嵌入与拔出往返测试</p>	<p>Contact Resistance $\leq 70m \Omega$</p> <p>接触电阻 $\leq 70m \Omega$</p>
7.7	Vibration 振动	<p>Mate connector combination state of the welding circuit board as test samples the request in accordance with the following specification resistance to vibration test whether to produce discontinuous current determined during the experiment (off) phenomenon after the experiment measuring contact resistance</p> <p>组合状态下的连接器焊接电路板上作为实验样品，依照如下规格要求，进行耐震动实验，实验过程中确定是否产生不连续电流（断电）现象，实验过后测量接触电阻值</p> <p>Frequency (频率) : 10-55-10 Hz/minute Amplitude (振幅) : 1.5mm p-p Direction (方向) :</p> <p>1、 Axis of up and down 上下轴向 (Y轴) 2、 Axis of right the left 左右轴向 (X轴) 3、 Axis of front and back 前后轴向 (Z轴)</p> <p>Period (周期) : 2hour for each direction 每一个轴向持续2小时</p>	<p>Appearance: No damage 外观: 无损伤</p> <p>Contact Resistance $\leq 70m \Omega$</p> <p>接触电阻 $\leq 70m \Omega$</p> <p>Current Discontinuity I micro second Max</p> <p>电流中断: 1 μ sec Max</p>



TITLE: 1.25MM PITCH GHD CONNECTOR DOUBLE ROW TYPE

PART No. : XD-GHD - ****

RELEASE DATE: 2020/8/20

REVISION: A

ECN No. :

PAGE: 8 OF 14

8、 Endurance Characteristics:

环境性能

No. 序号	Item 项目	Test mode 试验方法	Requirement 技术要求
8.1	Thermal Aging 高温老化实验	<p>Connector combination condition is placed in the accordance with the following specifications high temperature aging test after the test and measurement of contact resistance</p> <p>组合状态下的连接器放置与加热烤箱中，依照如下规格要求， 进行高温老化实验， 试验后并测量接触电阻值</p> <p>Temperature: 85± 2°C Period: 96 hours continuously 温度: 85±2°C 周期: 持续96小时</p>	<p>Appearance: No damage 外观: 无损伤</p> <p>Contact Resistance ≤70m Ω 接触电阻 ≤70m Ω</p>
8.2	Temperature 温升	<p>Mate connector measure the temperature rise of contact when the maximum rated current is passed</p> <p>组舍状态下的连接器， 通过最大容许电流测量导体温度上升值</p>	30°C Max



深圳讯答科技有限公司

TITLE: 1.25MM PITCH GHD CONNECTOR DOUBLE ROW TYPE

PART No. : XD-GHD - ****

RELEASE DATE: 2020/8/20

REVISION: A

ECN No. :

PAGE: 9 OF 14

8、Endurance Characteristics:

环境性能

No. 序号	Item 项目	Test mode 试验方法	Requirement 技术要求
8.3	Humidity 恒定潮湿	<p>Connector combination under the condition of constant temperature of the following specifications constant temperature and humidity test after the experiment measuring contact resistance insulation resistance and withstand voltage test</p> <p>组合状态下的连接器放置恒定温度的湿气空间, 依照如下规格要求, 进行恒温恒湿实验, 实验过后测量接触电阻、绝缘电阻以及耐电压测试</p> <p>Temperature: 40±2 °C (温度: 40±2 °C) Relative humidity: 90-95% (RH 相对湿度: 90-95%) Period: 96 hours continuously (周期: 持续96小时)</p>	<p>Appearance: No damage 外观: 无损伤</p> <p>Contact Resistance ≤70m Ω 接触电阻 ≤70m Ω</p> <p>Insulation Resistance ≥100m Ω</p> <p>No breakdown or flashover 无击穿或者产生火</p>
8.4	Temperature cycling 温度循环	<p>The combined state of connectors as test samples in accordance with the requirements of the following specifications thermal shock test after the test measuring contact resistance insulation resistance and resistance to voltage</p> <p>组合状态下的连接器作为实验样品, 依照如下规格要求进行冷热冲击实验, 试验后测量接触电阻、绝缘电阻、以及耐电压测试</p> <p>One cycle consists of -55±3 °C 30min, room temp 10-15min 85±3 °C 30min, room temp 10-15min Total cycle :5cycle -55±3°C 30分钟, 放置转换时间10-15分钟 85±3°C 30分钟, 放置转换时间10-15分钟 循环次数: 5次</p>	Same as paragraph 8.3 同8.3章节



TITLE: 1.25MM PITCH GHD CONNECTOR DOUBLE ROW TYPE

PART No. : XD-GHD - ****

RELEASE DATE: 2020/8/20

REVISION: A

ECN No. :

PAGE: 10 OF 14

8、Endurance Characteristics:

环境性能

No. 序号	Item 项目	Test mode 试验方法	Requirement 技术要求
8.5	Salt spray 盐雾	<p>The combined state of connector as test samples salt spray test according to the following specifications test samples will be clean again with the water to dry naturally measurement of contact resistance</p> <p>组合状态下的连接器作为实验样品，依照如下规格要求进行盐水喷雾实验，实验后将样品用清水冲干净自然晾干，测量接触电阻值</p> <p>Temperature : 35 ±3 °C Solution: 5± 1 % Period: Stamping after tin plated for 8 hours Stamping before tin plated for 48 hours</p> <p>温度: 35±3 °C 浓度: 5±1% 周期: 先电镀后冲压8 小时 先冲压后电镀48 小时</p>	<p>Appearance: No damage 外观: 无损伤</p> <p>Contact Resistance ≤70m Ω 接触电阻 ≤70m Ω</p>
8.6	Solder ability 可焊性	<p>In accordance with the following specifications were placed tin soldering test</p> <p>放置锡炉中依照如下规格进行焊锡实验</p> <p>Solder temperature : 245± 5° C Immersion period:: 3 ± 0.5S 焊锡温度: 245±5° C 沉浸周期: 3±0.5S</p>	<p>Area of soldering: ≥90 % 焊锡面积: ≥90 %</p>



TITLE: 1.25MM PITCH GHD CONNECTOR DOUBLE ROW TYPE

PART No. : XD-GHD - ****

RELEASE DATE: 2020/8/20

REVISION: A

ECN No. :

PAGE: 11 OF 14

8、 Endurance Characteristics:

环境性能

No. 序号	Item 项目	Test mode 试验方法	Requirement 技术要求
8.7.1	Resistance to soldering heat 耐焊接热	<p>annual soldering tin process Soldering time: 3±0.5S Soldering pot: 350±5°C 手工烙铁焊锡工艺 焊接时间: 3±0.5S 焊接温度: 350±5°C</p> <p>Mode of operation: 操作方式: Position DIP type needle solder conducto or a fixed piece at the end of the 0.5mm distance DIP型针座焊锡位置, 距离导体或固定片末端0.5mm</p> <p>Wave soldering tin soldering process Soldering time : 5± 0.5S Soldering pot: 230 ± 5 ° C 波峰焊焊锡工艺 焊接时间: 5±0.5S 焊接温度: 230±5°C</p>	<p>Appearance: No damage 外观: 无损伤</p>



TITLE: 1.25MM PITCH GHD CONNECTOR DOUBLE ROW TYPE

PART No. : XD-GHD - ****

RELEASE DATE: 2020/8/20

REVISION: A

ECN No. :

PAGE: 12 OF 14

8、 Endurance Characteristics:

环境性能

No. 序号	Item 项目	Test mode 试验方法	Requirement 技术要求
8.7.2	Resistance to soldering heat 耐焊接热	Reflow soldering process Soldering time 20 S Max. Soldering pot: 255 ± 5°C 回流焊锡工艺 焊接时间: 20S最大 焊接温度: 255±5° C Please refer to the 9.1 solder reflow temperature curve 回流焊请参考9.1温度曲线图	Appearance: No damage 外观: 无损伤



TITLE: 1.25MM PITCH GHD CONNECTOR DOUBLE ROW TYPE

PART No. : XD-GHD - ****

RELEASE DATE: 2020/8/20

REVISION: A

ECN No. :

PAGE: 13 OF 14

9、The reflow temperature curve

回流焊温度曲线

9.1 SMT lead-free process temperature curve

SMT无铅工艺温度曲线



10、Caution

注意事项

10.1 plastic because of characteristics exposure to the temperature is higher than 30°C , humidity is higher than 60% RH in the environment, and in the 24 hours after soldering process to produce foaming ter package is opened should avoid event subsequent reflow wave ion

塑料因具有吸水之特性包装拆封后应避免暴露于，高温于 30°C, 湿度高于 60%RH 的环境中，并在封后24小时内全数使用完毕，防止后续回流焊、波峰焊制程产生起泡变形现象



TITLE: 1.25MM PITCH GHD CONNECTOR DOUBLE ROW TYPE

PART No. : XD-GHD - ****

RELEASE DATE: 2020/8/20

REVISION: A

ECN No. :

PAGE: 14 OF 14

11、Packaging Transportation Storage

包装、运输、储存

11.1 Packaging

包装

(1) Terminal within the Packaging for disc loading material Packaging plastic shell packaging for plastic has seat plates tubes mounted (paste) into the certificate indicate the product name specifications quantity production date and other information
端子内包装为盘装带料包装、胶壳内包装为塑料带，针座包装为盘装，袋装，(贴)装入合格证，注明产品名称、规格型号、数量、出货日期等信息。

(2) Exterior package is carton facing the packing list the packing list marked with product name specification model quantity date of dispatch
外包装为纸箱，贴装箱单，装箱单上注明产品名称、规格型号、数量、出货日期

(3) The product in the box must not rock
产品在箱内不晃动

11.2 Transportation

运输

Any vehicle can be adopted for the transportation but moisture-proof and no mechanical damage Transport temperature to $-20\text{ }^{\circ}\text{C} \sim +50\text{ }^{\circ}\text{C}$
允许用任何方式运输，但须避免雨雪直淋和阳光照射。不能有碰撞和挤压等机械损伤，运输环境温度为 $-20\text{ }^{\circ}\text{C} \sim +50\text{ }^{\circ}\text{C}$

11.3 Storage

贮存

(1) The connector of packing finished should be in the ambient temperature between $-20\text{ }^{\circ}\text{C} \sim +40\text{ }^{\circ}\text{C}$ relative humidity $\leq 80\%$ to store in storehouse air and other corrosive gas in the ambient air
包装完毕的连接器应在环境温度 $-20\text{ }^{\circ}\text{C} \sim +40\text{ }^{\circ}\text{C}$ ，相对湿度 $\leq 80\%$ ，周围空气中没有酸性，碱性及其它腐蚀性气体的库房中贮存

(2) Re-qualification test shall be conducted immediately while the storing duration exceed 6 mouths
贮存期为6个月，超期6个月需从新检查

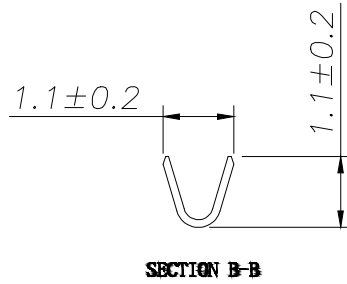
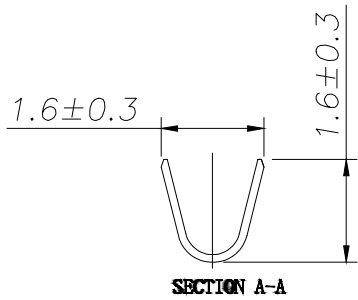
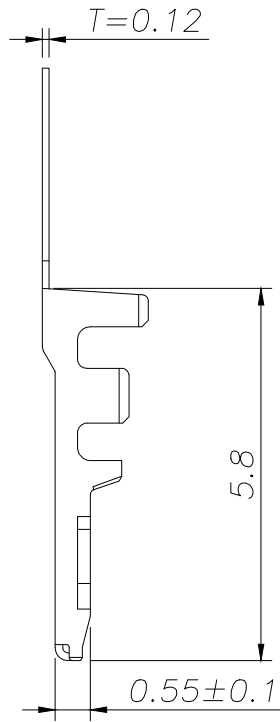
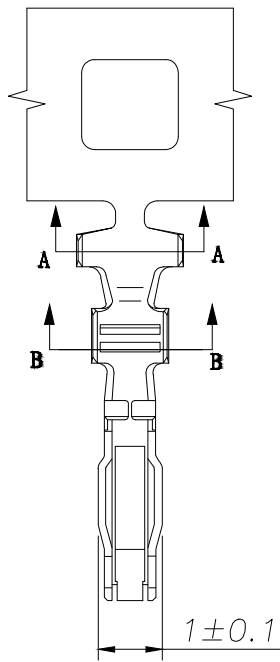

SPECIFICATIONS

- 1、 Current Rating: 1.25A AC, DC
- 2、 Voltage Rating: 50V AC, DC
- 3、 Temperatuer Range: -25°C~ +85°C
- 4、 Contact Resistance: 50mΩ Max
- 5、 Insulation Resistance: 100mΩ Min
- 6、 Withstanding Voltang: 500V AC/minute
- 7、 Material: Phosphoric brass Tin-plated
- 8、 Applicable Wire Sizes:AWG #26~30#

			GENEAL TOLERANCE	制图 DRAWING	05	深圳讯答科技有限公司 ShenzhenXundaTechnology Co.,Ltd			
			DIM TOL	审核 CHECK					
			X.X ±0.30	批准 APPROVAL		产品名称 TITLE	GHD (1.25) 端子	版本 REV.	A
			X.XX ±0.20	比例 SCALE		产品料号 PART NO.	XD-GHD-T	单位 UNITS	mm
			X.XXX ±0.10	投影 Projection		材料 MATERIAL		页次 SHEET	1/1
1	初版发行		Angle ±3.0°						
序号 No.	变更内容 MODIFY CONTENT	日期 MODIFY DATE							

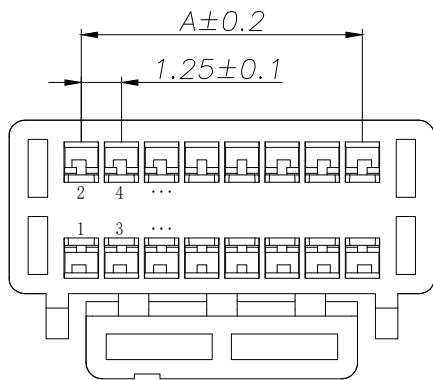
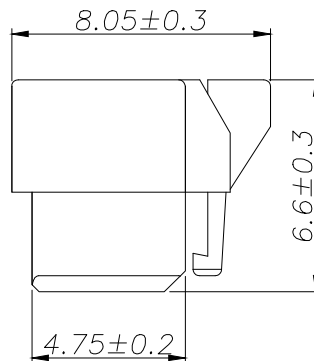
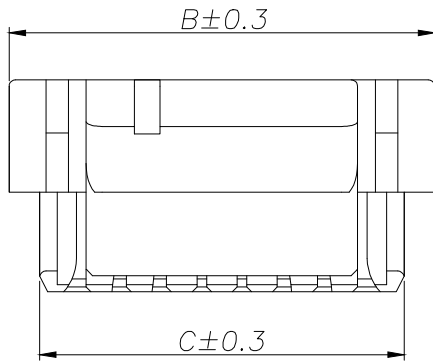
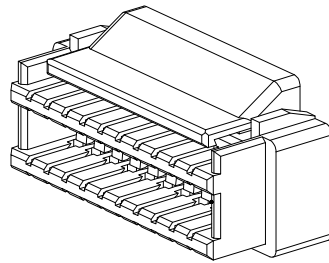
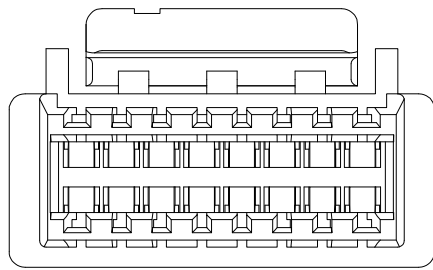

SPECIFICATIONS

- 1、 Current Rating: 1.25A AC, DC
- 2、 Voltage Rating: 50V AC, DC
- 3、 Temperature Range: -25°C~ +85°C
- 4、 Contact Resistance: 50mΩ Max
- 5、 Insulation Resistance: 100mΩ Min
- 6、 Withstanding Voltage: 500V AC/minute
- 7、 Material: PA66 UL94-V0

Circuit	Part NO.	Dimensions mm		
		A	B	C
2	XD-GHD-2x2Y	1.25	5.75	3.85
3	XD-GHD-2x3Y	2.50	7.00	5.10
4	XD-GHD-2x4Y	3.75	8.25	6.35
5	XD-GHD-2x5Y	5.00	9.50	7.60
6	XD-GHD-2x6Y	6.25	10.75	8.85
7	XD-GHD-2x7Y	7.50	12.00	10.10
8	XD-GHD-2x8Y	8.75	13.25	11.35
9	XD-GHD-2x9Y	10.00	14.50	12.60
10	XD-GHD-2x10Y	11.25	15.75	13.85
11	XD-GHD-2x11Y	12.50	17.00	15.10
12	XD-GHD-2x12Y	13.75	18.25	16.35
13	XD-GHD-2x13Y	15.00	19.50	17.60
14	XD-GHD-2x14Y	16.25	20.75	18.85
15	XD-GHD-2x15Y	17.50	22.00	20.10
16	XD-GHD-2x16Y	18.75	23.25	21.35
17	XD-GHD-2x17Y	20.00	24.50	22.60
18	XD-GHD-2x18Y	21.25	25.75	23.85
19	XD-GHD-2x19Y	22.50	27.00	25.10
20	XD-GHD-2x20Y	23.75	28.25	26.35

Ordering Information

XD - GHD - 2xN *** - *

Pin Type Colour
 2=蓝色 2=蓝色
 4=蓝色 4=蓝色
 6=蓝色 6=蓝色
 8=蓝色 8=蓝色
 10=蓝色 10=蓝色
 12=蓝色 12=蓝色
 14=蓝色 14=蓝色
 16=蓝色 16=蓝色
 18=蓝色 18=蓝色
 20=蓝色 20=蓝色

序号 No.	变更内容 MODIFY CONTENT	日期 MODIFY DATE	GENERAL TOLERANCE	制图 DRAWING	05	深圳讯答科技有限公司 ShenzhenXundaTechnology Co.,Ltd			
1	初版发行		DIM TOL	审核 CHECK		产品名称 TITLE	GHD (1.25)双排孔座	版本 REV.	A
			X.X ±0.30	批准 APPROVAL		产品料号 PART NO.	XD-GHD-2xNY	单位 UNITS	mm
			X.XX ±0.20	比例 SCALE		材料 MATERIAL		页次 SHEET	1/1
			X.XXX ±0.10	投影 Projection					
			Angle ±3.0°						

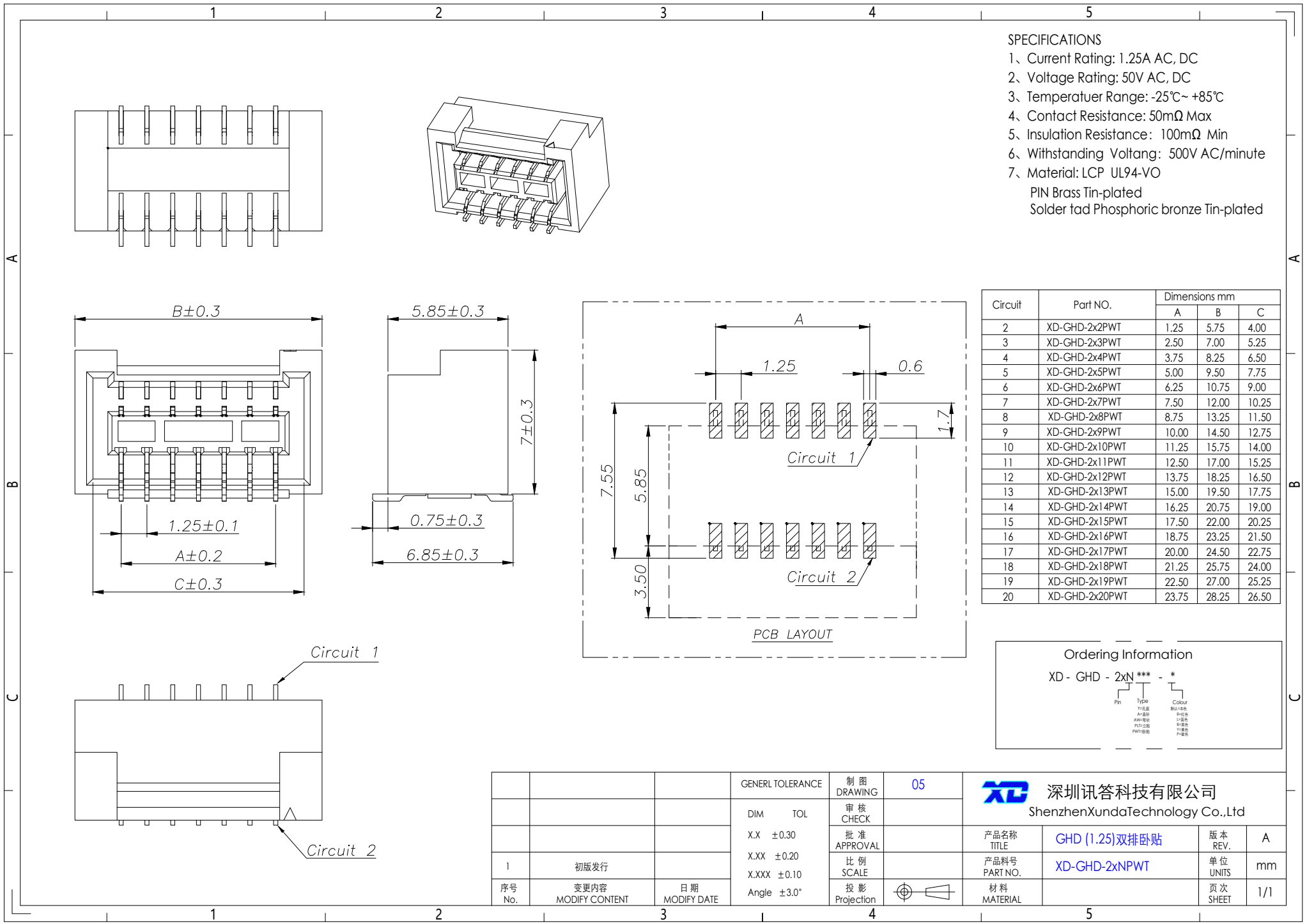

- SPECIFICATIONS**
- 1、 Current Rating: 1.25A AC, DC
 - 2、 Voltage Rating: 50V AC, DC
 - 3、 Temperature Range: -25°C~ +85°C
 - 4、 Contact Resistance: 50mΩ Max
 - 5、 Insulation Resistance: 100mΩ Min
 - 6、 Withstanding Voltage: 500V AC/minute
 - 7、 Material: LCP UL94-VO
PIN Brass Tin-plated
Solder pad Phosphoric bronze Tin-plated

Circuit	Part NO.	Dimensions mm		
		A	B	C
2	XD-GHD-2x2PWT	1.25	5.75	4.00
3	XD-GHD-2x3PWT	2.50	7.00	5.25
4	XD-GHD-2x4PWT	3.75	8.25	6.50
5	XD-GHD-2x5PWT	5.00	9.50	7.75
6	XD-GHD-2x6PWT	6.25	10.75	9.00
7	XD-GHD-2x7PWT	7.50	12.00	10.25
8	XD-GHD-2x8PWT	8.75	13.25	11.50
9	XD-GHD-2x9PWT	10.00	14.50	12.75
10	XD-GHD-2x10PWT	11.25	15.75	14.00
11	XD-GHD-2x11PWT	12.50	17.00	15.25
12	XD-GHD-2x12PWT	13.75	18.25	16.50
13	XD-GHD-2x13PWT	15.00	19.50	17.75
14	XD-GHD-2x14PWT	16.25	20.75	19.00
15	XD-GHD-2x15PWT	17.50	22.00	20.25
16	XD-GHD-2x16PWT	18.75	23.25	21.50
17	XD-GHD-2x17PWT	20.00	24.50	22.75
18	XD-GHD-2x18PWT	21.25	25.75	24.00
19	XD-GHD-2x19PWT	22.50	27.00	25.25
20	XD-GHD-2x20PWT	23.75	28.25	26.50

Ordering Information

XD - GHD - 2xN *** - *

Pin: 1=无引脚, 2=有引脚
Type: A=单排, B=双排
Colour: 1=镀锡, 2=镀银, 3=镀金, 4=磷铜, 5=黄铜, 6=紫铜, 7=不锈钢, 8=铜

GENERAL TOLERANCE		制图	05
DIM TOL		审核	
X.X ±0.30		批准	
X.XX ±0.20		比例	
X.XXX ±0.10		投影	
Angle ±3.0°			
1	初版发行	日期	
序号 No.	变更内容 MODIFY CONTENT	日期 MODIFY DATE	

XD 深圳讯答科技有限公司
Shenzhen Xunda Technology Co., Ltd

产品名称 TITLE	GHD (1.25) 双排卧贴	版本 REV.	A
产品料号 PART NO.	XD-GHD-2xNPWT	单位 UNITS	mm
材料 MATERIAL		页次 SHEET	1/1

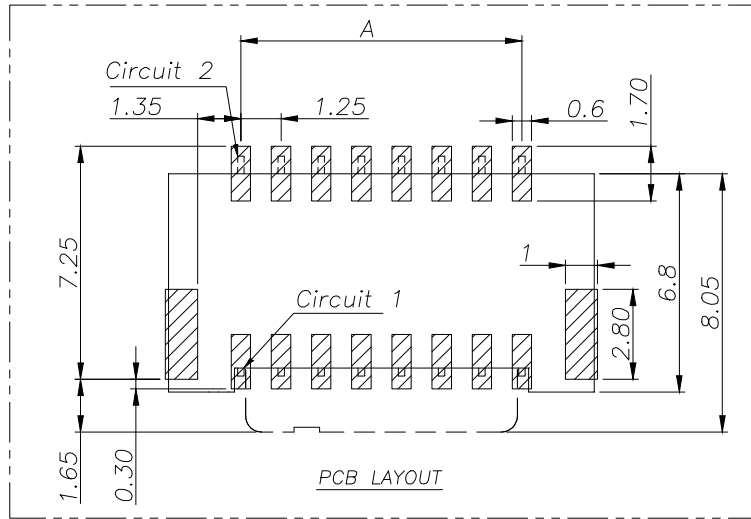
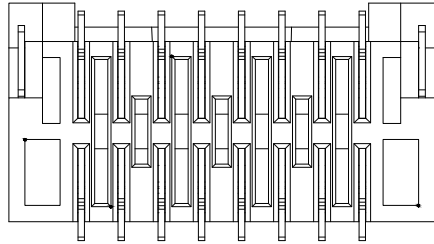

SPECIFICATIONS

- 1、Current Rating: 1.25A AC, DC
- 2、Voltage Rating: 50V AC, DC
- 3、Temperatuer Range: -25°C~ +85°C
- 4、Contact Resistance: 50mΩ Max
- 5、Insulation Resistance: 100mΩ Min
- 6、Withstanding Voltang: 500V AC/minute
- 7、Material: LCP UL94-VO
PIN Brass Tin-plated
Solder tad Phosphoric bronze Tin-plated

Circuit	Part NO.	Dimensions mm		
		A	B	C
2	XD-GHD-2x2PLT	1.25	5.75	4.00
3	XD-GHD-2x3PLT	2.50	7.00	5.25
4	XD-GHD-2x4PLT	3.75	8.25	6.50
5	XD-GHD-2x5PLT	5.00	9.50	7.75
6	XD-GHD-2x6PLT	6.25	10.75	9.00
7	XD-GHD-2x7PLT	7.50	12.00	10.25
8	XD-GHD-2x8PPLT	8.75	13.25	11.50
9	XD-GHD-2x9PLT	10.00	14.50	12.75
10	XD-GHD-2x10PLT	11.25	15.75	14.00
11	XD-GHD-2x11PLT	12.50	17.00	15.25
12	XD-GHD-2x12PLT	13.75	18.25	16.50
13	XD-GHD-2x13PLT	15.00	19.50	17.75
14	XD-GHD-2x14PLT	16.25	20.75	19.00
15	XD-GHD-2x15PLT	17.50	22.00	20.25
16	XD-GHD-2x16PLT	18.75	23.25	21.50
17	XD-GHD-2x17PLT	20.00	24.50	22.75
18	XD-GHD-2x18PLT	21.25	25.75	24.00
19	XD-GHD-2x19PLT	22.50	27.00	25.25
20	XD-GHD-2x20PLT	23.75	28.25	26.50

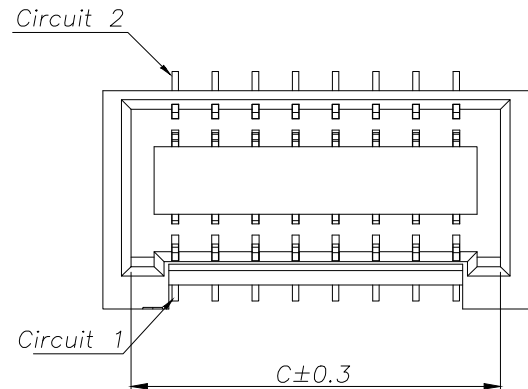
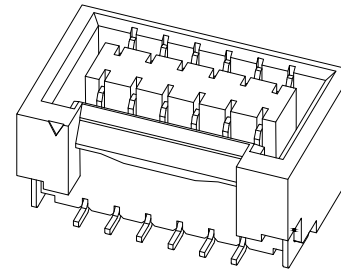
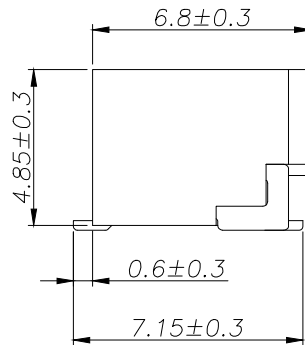
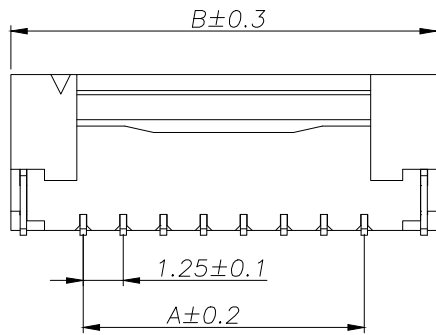

Ordering Information

XD - GHD - 2xN *** - *

Pin Type Colour
 2=1.25mm 4=1.25mm 5=1.25mm
 3=1.25mm 6=1.25mm 7=1.25mm
 8=1.25mm 9=1.25mm 10=1.25mm
 11=1.25mm 12=1.25mm 13=1.25mm
 14=1.25mm 15=1.25mm 16=1.25mm
 17=1.25mm 18=1.25mm 19=1.25mm
 20=1.25mm

GENERAL TOLERANCE			制图	05
DIM TOL			DRAWING	
X.X ±0.30			审核	
X.XX ±0.20			CHECK	
X.XXX ±0.10			批准	
Angle ±3.0°			APPROVAL	
			比例	
			SCALE	
			投影	
			Projection	
1	初版发行	日期		
序号	变更内容	日期		
No.	MODIFY CONTENT	MODIFY DATE		

深圳讯答科技有限公司 ShenzhenXundaTechnology Co.,Ltd			
产品名称	GHD (1.25)双排立贴	版本	A
TITLE		REV.	
产品料号	XD-GHD-2xNPLT	单位	mm
PART NO.		UNITS	
材料		页次	1/1
MATERIAL		SHEET	

X-ON Electronics

Largest Supplier of Electrical and Electronic Components

Click to view similar products for [Headers & Wire Housings](#) category:

Click to view products by [chxunda](#) manufacturer:

Other Similar products are found below :

[0015917161](#) [0022155065](#) [57102-F02-18ULF](#) [58102-G61-06LF](#) [582553-1](#) [01.001.5753.1](#) [0050291907](#) [02.125.8002.8](#) [609-3404](#) [61062-3](#)
[CSU011177004](#) [622-0430](#) [622-3653LF](#) [63453-116](#) [636-1030](#) [636-1427](#) [636-3427](#) [636-4007](#) [641938-9](#) [65495-038](#) [65692-001LF](#) [65781-018](#)
[65781-047](#) [65817-010LF](#) [65817-015LF](#) [67095-007LF](#) [67601157](#) [68631-112](#) [68645-018](#) [699319-000](#) [70.362.1628.0](#) [70-4210](#) [70-4226B](#) [70-](#)
[4853B](#) [71.350.2428.0](#) [733-134](#) [733-162](#) [760-3052](#) [MHR-64-VUAL](#) [80.063.4001.1](#) [800-90-001-10-001000](#) [801-43-002-10-013000](#)
[801-43-006-10-002000](#) [803-43-024-10-001000](#) [803-93-012-10-001000](#) [8-1437020-4](#) [819-22-004-30-001101](#) [820-22-006-30-001101](#)
[820-22-008-30-001101](#) [821-22-002-10-001101](#)