



深圳讯答科技有限公司

物料承认书

SPECIFICATION FOR APPROVAL

系列号:
Description: XD XA (2.5) 系列

间距型号:
CONN TYPE: 2.5 mm WTB SMT CONN

承认签章 CUSTOMER

校对 Issuer

审核 Engineer

批准 Approver

| | | |
|-----|---|-----|
| 李攀进 | / | 罗观彬 |
|-----|---|-----|

地址：深圳市宝安区新安街道安乐社区40区安乐工业园2号厂房B713-2

[Http://www.chxunda.com](http://www.chxunda.com)

产 品 承 认 书 目 录

| | |
|--------|-------|
| 1、封面 | 1-1 |
| 2、目录 | 2-2 |
| 3、技术规范 | 3-14 |
| 4、产品图纸 | 15-** |



TITLE: 2.50MM PITCH XA CONNECTOR DOUBLE ROW TYPE

PART No. : XD- XA - ****

RELEASE DATE: 2019/7/25

REVISION: A

ECN No. :

PAGE: 3 OF 14

1、Scope

适用范围

The contents of specifications for XA series connector strip including product performance, test methods and inspection requirements

本规格书内容适用于 XA 形连接器，包含了产品的性能，试验方法和试验要求

2、APPLICABLE STANDARDS

适用的标准

- | | | |
|-----|----------|---|
| 2.1 | GB/T2421 | Testing method for Environmental of Electrical Connectors Class 1: General Principles |
| | GB/T2421 | 电工电子产品环境试验 第一部分 总则 |
| 2.2 | GB/T2423 | Testing method for Environmental of Electrical Connectors |
| | GB/T2423 | 电工电子产品环境试验方法 |
| 2.3 | GB/T2424 | Testing method for Environmental of Electrical Connectors |
| | GB/T2424 | 电工电子产品环境试验导则 |
| 2.4 | GB/T5095 | Testing procedure/method for components of electric equipment |
| | GB/T5095 | 电子设备用机电元件基本试验规则及测量方法 |

3、USE CONDITION

使用条件

- 3.1 Ambient temperature Range: $-25^{\circ}\text{C} \sim +85^{\circ}\text{C}$
环境温度: $-25^{\circ}\text{C} \sim +85^{\circ}\text{C}$
- 3.2 Applicable Wire Sizes: AWG #22~#28
适用线规: AWG 22~#28
- 3.3 Applicable PC board thickness: 1.6mm
适用PC板厚度: 1.6mm

4、Appearance and Dimension

外观尺寸

- 4.1 Appearance : Product surface without defect 、 dirt、 crack、 and mechanical damage, Contact without rust plating not oxides and not peeled
产品表面不应有对制品有害的缺陷、污垢、裂痕及机械损伤；接触件无锈蚀、镀层氧化、脱落等现象。
- 4.2 Dimension: According to drawings
外观尺寸: 依照附图
- 4.3 Exchangeable: Exchangeable with same specification products.
互换性: 相同规格应能互换



TITLE: 2.50MM PITCH XA CONNECTOR DOUBLE ROW TYPE

PART No. : XD- XA - ****

RELEASE DATE: 2019/7/25

REVISION: A

ECN No. :

PAGE: 4 OF 14

5、Material

材料

| No. 序号 | P/N 零件名称 | Type 类型 | Material 材料 | Finish 表面处理 | Explain 说明 |
|-----------|-------------------|-------------------|-------------------------------|--------------------------------------|---------------|
| 5.1 | Terminal 端子-PT | Contact 插簧 | Phosphor bronze 锡青磷铜厚0.2mm | Tin plating:3~5μ m 镀锡: 3~5μ m | ROHS |
| 5.2 | Housing 孔座-P | Plastic 塑壳 | Nylon66 UL94V-0 | Color: White 颜色: 白色 | |
| 5.3 | Wafer 针座 | Plastic 塑壳 | Nylon66 UL94V-0 | Color: Beige 颜色: 米色 | |
| | | Contact 插针 | Brass 黄铜 厚 0.60mm | Tin plating:2.5~5μ m 镀锡: 2.5~5μ m | |
| 5.4 | Wafer 立/卧贴针座 | Plastic 塑壳 | LCP UL94V-0 | Color: Beige 颜色: 米色 | |
| | | Contact 插针 | Brass 黄铜 厚0.60mm | Tin plating:2.5~5 μ m 镀锡2.5~5 μm | |
| | | Solder tab 焊护耳 | Brass 黄铜 厚0.40mm | Tin plating:2.5~5 μ m 镀锡2.5~5 μm | |



TITLE: 2.50MM PITCH XA CONNECTOR DOUBLE ROW TYPE

PART No. : XD- XA - ****

RELEASE DATE: 2019/7/25

REVISION: A

ECN No. :

PAGE: 5 OF 14

6、Electrical Performance

电气性能

| No. 序号 | Item 项目 | Test mode 试验方法 | Requirement 技术要求 |
|-----------|-------------------------------|--|---|
| 6.1 | Current Rated 额定电流 | | 3A AC DC |
| 6.2 | Voltage Rated 额定电压 | | 250V AC DC |
| 6.3 | Contact Resistance 接触电阻 | <p>A maximum voltage of 20mV and maximum current of 100mA are applied to the Mate connector</p> <p>组合状态下的连接器，两端施以最大测试电压 20mV以及最大测试电流 100 mA</p> <p>Does not include wire resistance</p> <p>不包含电线阻抗</p> | <p>Initial value less than 20mΩ</p> <p>初始值 ≤ 20mΩ</p> |
| 6.4 | Withstand voltage 耐电压 | <p>Apply 1000V AC(rms) for 1 minute and the leakage current shall not exceed 0.5mA to the adjacent terminal and ground of the mate connectors</p> <p>组合状态下的连接器，相邻两导体末端各施以电压1000V AC（有效值）时间1分钟，且漏电流必须小于0.5mA（毫安培）</p> | <p>No breakdown or flashover</p> <p>无击穿或者产生火花</p> |
| 6.5 | Insulation Resistance 绝缘电阻 | <p>Apply 500V DC(rms) for 1 minute between adjacent contacts to measure the insulation resistance</p> <p>相邻两接触导体，一分钟内施以 500V DC电压，测量期间的绝缘阻抗值</p> | <p>More than 1000 MΩ</p> <p>≥1000M Ω</p> |



TITLE: 2.50MM PITCH XA CONNECTOR DOUBLE ROW TYPE

PART No. : XD- XA - ****

RELEASE DATE: 2019/7/25

REVISION: A

ECN No. :

PAGE: 6 OF 14

7、 Mechanical Performance:

机械性能

| No. 序号 | Item 项目 | Test mode 试验方法 | Requirement 技术要求 |
|-----------|--|---|---|
| 7.1 | Terminal crimping Wire strength 端子压接导线强度 | Terminal crimping wire Axial per minute to 25 ±3mm rate of the pullout force 端子所压接电线，以每分钟 25±3mm 速之轴向拔出力 | AWG#22wire AWG#22导线 More than 50N ≥50N |
| | | | AWG#24wire AWG#24导线 More than 30N ≥30N |
| | | | AWG#26wire AWG#26导线 More than 20N ≥20N |
| | | | AWG#28wire AWG#28导线 More than 13N ≥13N |
| 7.2 | Fixed terminals And hole seat 端子与孔座固定力 | The terminal and the hole seat at a react per minute to 25 ±3mm along the write direction are pulled out from the hole in the seat capacity 端子与孔座配合以每分钟 25±3mm 的速度 沿导线方向,将端子从孔座中拔出的力 | Percontact 单一接触点 More than 15N ≥15N |
| 7.3 | Single contact insertion force 单接触插入力 | The housing together with the terminal ends with wafer matched at a rate per minute to 25±3mm inserting force test 孔座连同端子与针座两端互配以每分钟 25 ±3mm 的速度作插入力测试 | Less than 7N ≤7N |
| 7.4 | Single contact Withdrawal force 单接触拔出力 | The housing together with the terminal ends with wafer matched at a rate per minute to 25±3mm inserting force test 孔座连同端子与针座两端互配以每分钟 25 ±3mm 的速度作拔出力测试 | More than 1N ≥1N |
| 7.5 | Pin Retention Force pin Pin针固定力 | Exerts a force on the pin end at a rate per Minute 25±3mm until the needle exit Seat pull-out force 在脚端施加力以每分钟 25±3mm 的速度直到 针退出针座的拔出力 | Percontact 单一接触点 More than 15N ≥15N |



深圳讯答科技有限公司

TITLE: 2.50MM PITCH XA CONNECTOR DOUBLE ROW TYPE

PART No. : XD- PH - ****

RELEASE DATE: 2019/7/25

REVISION: A

ECN No. :

PAGE: 7 OF 14

7、 Mechanical Performance:

机械性能

| No. 序号 | Item 项目 | Test mode 试验方法 | Requirement 技术要求 |
|-----------|-------------------|--|--|
| 7.6 | Durability 耐久性 | <p>Mate connectors up 30 cycles at a Maximum rate of 10 cycles per minute prior to environmental test</p> <p>组合状态下的连接器且未经环境测试每分钟内进行10次嵌入与拔出，连续30次嵌入与拔出往返测试</p> | <p>Contact Resistance $\leq 30m \Omega$</p> <p>接触电阻 $\leq 30m \Omega$</p> |
| 7.7 | Vibration 振动 | <p>Mate connector combination state of the welding circuit board as test samples the request in accordance with the following specification resistance to vibration test whether to produce discontinuous current determined during the experiment (off) phenomenon after the experiment measuring contact resistance</p> <p>组合状态下的连接器焊接电路板上作为实验样品，依照如下规格要求，进行耐震动实验，实验过程中确定是否产生不连续电流（断电）现象，实验过后测量接触电阻值</p> <p>Frequency (频率) :10-55-10 Hz/minute Amplitude (振幅) : 1.5mm p-p Direction (方向) : 1、 Axis of up and down 上下轴向 (Y轴) 2、 Axis of right the left 左右轴向 (X轴) 3、 Axis of front and back 前后轴向 (Z轴)</p> <p>Period (周期) : 2hour for each direction 每一个轴向持续2小时</p> | <p>Appearance: No damage 外观: 无损伤</p> <p>Contact Resistance $\leq 30m \Omega$ 接触电阻 $\leq 30m \Omega$</p> <p>Current Discontinuity I micro second Max 电流中断: 1 μ sec Max</p> |



TITLE: 2.50MM PITCH XA CONNECTOR DOUBLE ROW TYPE

PART No. : XD- XA - ****

RELEASE DATE: 2019/7/25

REVISION: A

ECN No. :

PAGE: 8 OF 14

8、 Endurance Characteristics:

环境性能

| No. 序号 | Item 项目 | Test mode 试验方法 | Requirement 技术要求 |
|-----------|-------------------------|--|---|
| 8.1 | Thermal Aging 高温老化实验 | <p>Connector combination condition is placed in the accordance with the following specifications high temperature aging test after the test and measurement of contact resistance</p> <p>组合状态下的连接器放置与加热烤箱中，依照如下规格要求，进行高温老化实验，试验后并测量接触电阻值</p> <p>Temperature: 85± 2°C Period: 96 hours continuously 温度: 85±2°C 周期: 持续96小时</p> | <p>Appearance: No damage 外观: 无损伤</p> <p>Contact Resistance ≤30m Ω 接触电阻 ≤30m Ω</p> |
| 8.2 | Temperature 温升 | <p>Mate connector measure the temperature rise of contact when the maximum rated current is passed</p> <p>组舍状态下的连接器，通过最大容许电流测量导体温度上升值</p> | 30°C Max |



TITLE: 2.50MM PITCH XA CONNECTOR DOUBLE ROW TYPE

PART No. : XD- XA - ****

RELEASE DATE: 2019/7/25

REVISION: A

ECN No. :

PAGE: 9 OF 14

8、 Endurance Characteristics:

环境性能

| No. 序号 | Item 项目 | Test mode 试验方法 | Requirement 技术要求 |
|-----------|-----------------------------|--|--|
| 8.3 | Humidity 恒定潮湿 | <p>Connector combination under the condition of constant temperature of the following specifications constant temperature and humidity test after the experiment measuring contact resistance insulation resistance and withstand voltage test</p> <p>组合状态下的连接器放置恒定温度的湿气空间，依照如下规格要求，进行恒温恒湿实验，实验过后测量接触电阻、绝缘电阻以及耐电压测试</p> <p>Temperature: 40±2 °C (温度: 40±2 °C) Relative humidity: 90-95% (RH 相对湿度: 90-95%) Period: 96 hours continuously (周期: 持续96小时)</p> | <p>Appearance: No damage 外观: 无损伤</p> <p>Contact Resistance ≤30m Ω 接触电阻 ≤30m Ω</p> <p>Insulation Resistance ≥500m Ω</p> <p>No breakdown or flashover 无击穿或者产生火</p> |
| 8.4 | Temperature cycling 温度循环 | <p>The combined state of connectors as test samples in accordance with the requirements of the following specifications thermal shock test after the test measuring contact resistance insulation resistance and resistance to voltage</p> <p>组合状态下的连接器作为实验样品，依照如下规格要求进行冷热冲击实验，试验后测量接触电阻、绝缘电阻、以及耐电压测试</p> <p>One cycle consists of -55±3 °C 30min, room temp 10-15min 85±3 °C 30min, room temp 10-15min Total cycle :5cycle -55±3°C 30分钟，放置转换时间10-15分钟 85±3°C 30分钟，放置转换时间10-15分钟 钟循环次数: 5次</p> | <p>Same as paragraph 8.3 同8.3章节</p> |



TITLE: 2.50MM PITCH XA CONNECTOR DOUBLE ROW TYPE

PART No. : XD- XA - ****

RELEASE DATE: 2019/7/25

REVISION: A

ECN No. :

PAGE: 10 OF 14

8、 Endurance Characteristics:

环境性能

| No. 序号 | Item 项目 | Test mode 试验方法 | Requirement 技术要求 |
|-----------|-----------------------|---|--|
| 8.5 | Salt spray 盐雾 | <p>The combined state of connector as test samples salt spray test according to the following specifications test samples will be clean again with the water to dry naturally measurement of contact resistance</p> <p>组合状态下的连接器作为实验样品，依照如下规格要求进行盐水喷雾实验，实验后将样品用清水冲干净自然晾干，测量接触电阻值</p> <p>Temperature : 35 ±3 °C Solution: 5± 1 % Period: Stamping after tin plated for 8 hours Stamping before tin plated for 24 hours</p> <p>温度： 35±3 °C 浓度： 5±1% 周期： 先电镀后冲压8 小时 先冲压后电镀24 小时（接触区）</p> | <p>Appearance: No damage 外观：无损伤</p> <p>Contact Resistance ≤30m Ω 接触电阻 ≤30m Ω</p> |
| 8.6 | Solder ability 可焊性 | <p>In accordance with the following specifications were placed tin soldering test</p> <p>放置锡炉中依照如下规格进行焊锡实验</p> <p>Solder temperature : 245± 5° C Immersion period: 3 ± 0.5S 焊锡温度： 245±5° C 沉浸周期： 3±0.5S</p> | <p>Area of soldering: ≥90 % 焊锡面积： ≥90 %</p> |



TITLE: 2.50MM PITCH XA CONNECTOR DOUBLE ROW TYPE

PART No. : XD- XA - ****

RELEASE DATE: 2019/7/25

REVISION: A

ECN No. :

PAGE: 11 OF 14

8、 Endurance Characteristics:

环境性能

| No. 序号 | Item 项目 | Test mode 试验方法 | Requirement 技术要求 |
|-----------|--------------------------------------|---|--|
| 8.7.1 | Resistance to soldering heat 耐焊接热 | <p>Manual soldering tin process Soldering time: 3±0.5S Soldering pot: 350±5℃ 手工烙铁焊锡工艺 焊接时间: 3±0.5S 焊接温度: 350±5℃</p> <p>Mode of operation: 操作方式: Position DIP type needle solder conducto or a fixed piece at the end of the 1.5mm distance DIP型针座焊锡位置, 距离导体或固定片末端 1.5mm</p> <p>Wave soldering tin soldering process Soldering time : 5± 0.5S Soldering pot: 260 ± 5 ° C 波峰焊焊锡工艺 焊接时间: 5±0.5S 焊接温度: 260±5℃</p> | <p>Appearance: No damage 外观: 无损伤</p> |



TITLE: 2.50MM PITCH XA CONNECTOR DOUBLE ROW TYPE

PART No. : XD- XA - ****

RELEASE DATE: 2019/7/25

REVISION: A

ECN No. :

PAGE: 12 OF 14

8、 Endurance Characteristics:

环境性能

| No. 序号 | Item 项目 | Test mode 试验方法 | Requirement 技术要求 |
|-----------|--------------------------------------|---|--------------------------------------|
| 8.7.2 | Resistance to soldering heat 耐焊接热 | Reflow soldering process Soldering time 20 S Max. Soldering pot: 255 ± 5°C 回流焊焊锡工艺 焊接时间: 20S最大 焊接温度: 255±5° C Please refer to the 9.1 solder reflow temperature curve 回流焊请参考9.1温度曲线图 | Appearance: No damage 外观: 无损伤 |



TITLE: 2.50MM PITCH XA CONNECTOR DOUBLE ROW TYPE

PART No. : XD- XA - ****

RELEASE DATE: 2019/7/25

REVISION: A

ECN No. :

PAGE: 13 OF 14

9、The reflow temperature curve

回流焊温度曲线

9.1 SMT lead-free process temperature curve

SMT无铅工艺温度曲线

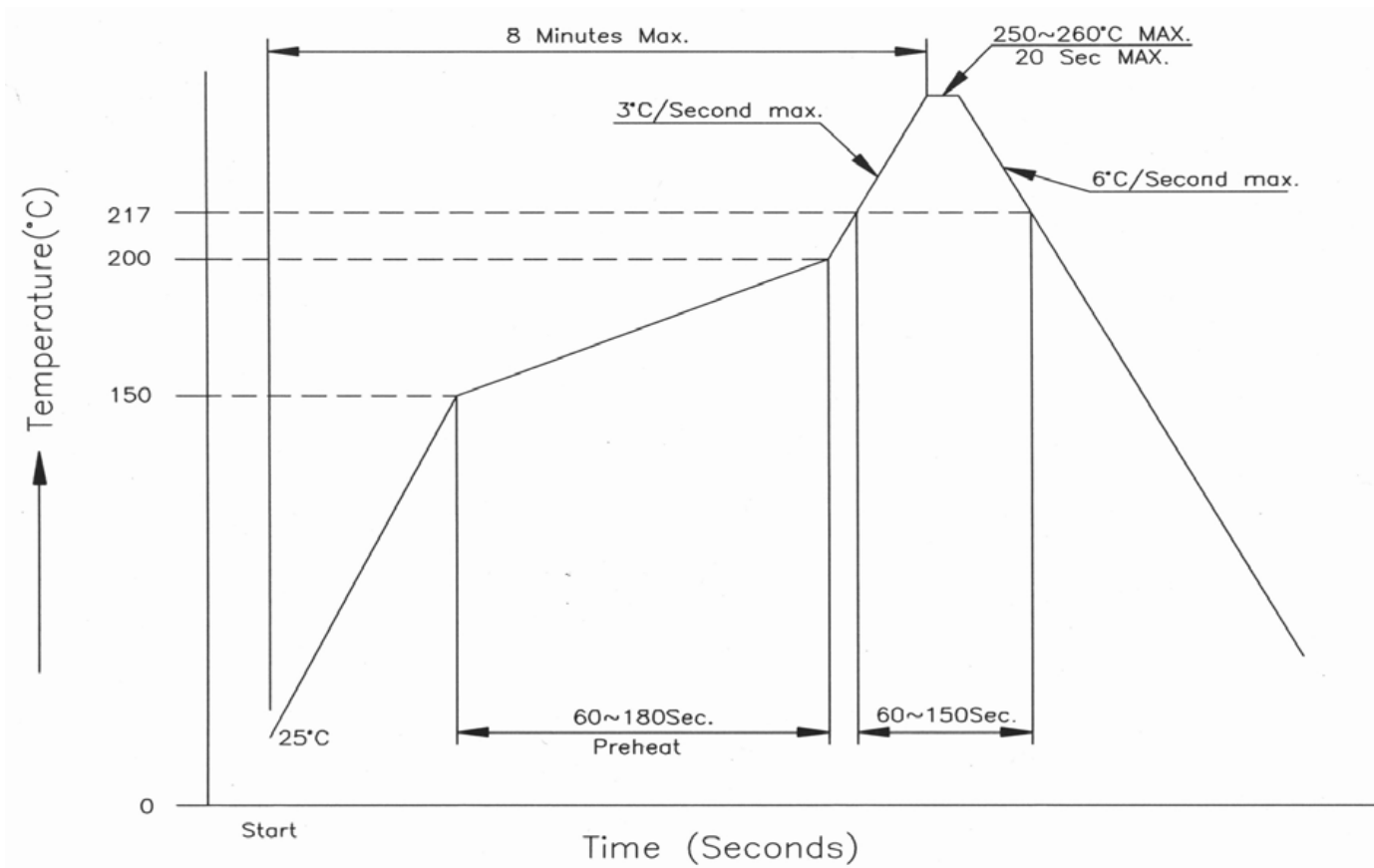

10、Caution

注意事项

10.1 plastic because of characteristics exposure to the temperature is higher than 30°C , humidity is higher than 60% RH in the environment, and in the 24 hours after soldering process to produce foaming ter package is opened should avoid event subsequent reflow wave ion

塑料因具有吸水之特性包装拆封后应避免暴露于，高温于 30°C,湿度高于 60%RH 的环境中，并在封后24小时内全数使用完毕，防止后续回流焊、波峰焊制程产生起泡变形现象



TITLE: 2.50MM PITCH HY CONNECTOR DOUBLE ROW TYPE

PART No. : XD- XA - ****

RELEASE DATE: 2019/7/25

REVISION: A

ECN No. :

PAGE: 14 OF 14

11、Packaging Transportation Storage

包装、运输、储存

11.1 Packaging

包装

(1) Terminal within the Packaging for disc loading material Packaging plastic shell packaging for plastic has seat plates tubes mounted (paste) into the certificate indicate the product name specifications quantity production date and other information

端子内包装为盘装带料包装、胶壳内包装为塑料带，针座包装为盘装，袋装，(贴) 装入合格证，注明产品名称、规格型号、数量、出货日期等信息。

(2) Exterior package is carton facing the packing list the packing list marked with product name specification model quantity date of dispatch

外包装为纸箱，贴装箱单，装箱单上注明产品名称、规格型号、数量、出货日期

(3) The product in the box must not rock

产品在箱内不晃动

11.2 Transportation

运输

Any vehicle can be adopted for the transportation but moisture-proof and no mechanical damage Transport temperature to $-20\text{ }^{\circ}\text{C} \sim +50\text{ }^{\circ}\text{C}$

允许用任何方式运输，但须避免雨雪直淋和阳光照射。不能有碰撞和挤压等机械损伤，运输环境温度为 $-20\text{ }^{\circ}\text{C} \sim +50\text{ }^{\circ}\text{C}$

11.3 Storage

贮存

(1) The connector of packing finished should be in the ambient temperature between $-20\text{ }^{\circ}\text{C} \sim +40\text{ }^{\circ}\text{C}$ relative humidity $\leq 80\%$ to store in storehouse air and other corrosive gas in the ambient air

包装完毕的连接器应在环境温度为 $-20\text{ }^{\circ}\text{C} \sim +40\text{ }^{\circ}\text{C}$ ，相对湿度 $\leq 80\%$ ，周围空气中没有酸性，碱性及其它腐蚀性气体的库房中贮存

(2) Re-qualification test shall be conducted immediately while the storing duration exceed 6 mouths

贮存期为6个月，超期6个月需从新检查

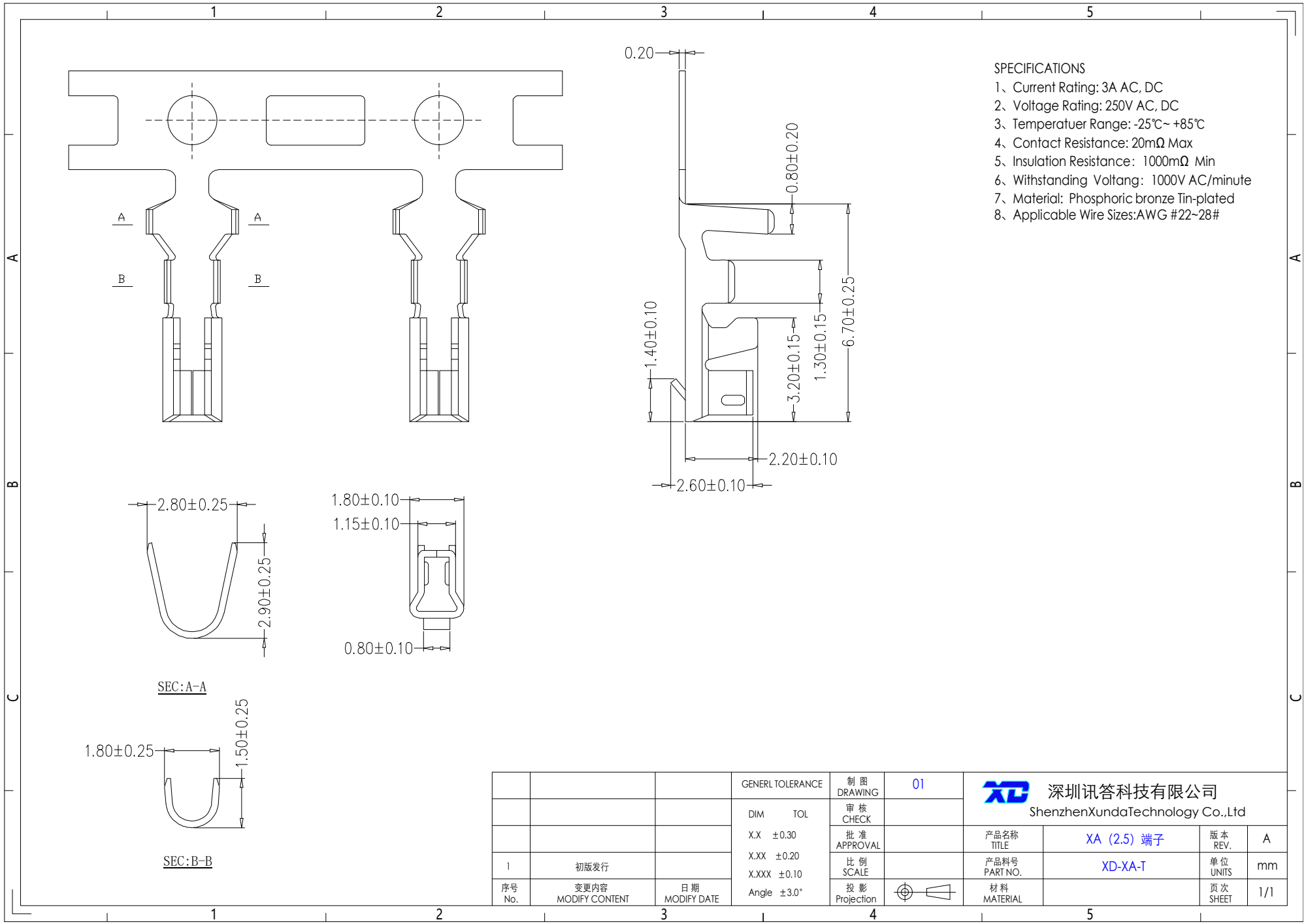

SPECIFICATIONS

- 1、Current Rating: 3A AC, DC
- 2、Voltage Rating: 250V AC, DC
- 3、Temperatuer Range: -25°C~ +85°C
- 4、Contact Resistance: 20mΩ Max
- 5、Insulation Resistance: 1000mΩ Min
- 6、Withstanding Voltang: 1000V AC/minute
- 7、Material: Phosphoric bronze Tin-plated
- 8、Applicable Wire Sizes:AWG #22~28#

| | | | | | | | | | | |
|-----------|------------------------|-------------------|------------------|------------------|------------------|--|-------------|--|-------------|-----|
| | | | GENERL TOLERANCE | 制图 DRAWING | 01 | | | | | |
| | | | DIM TOL | 审核 CHECK | | | | | | |
| | | | X.X ±0.30 | 批准 APPROVAL | 产品名称 TITLE | | XA (2.5) 端子 | | 版本 REV. | A |
| 1 初版发行 | | | X.XX ±0.20 | 比例 SCALE | 产品料号 PART NO. | | XD-XA-T | | 单位 UNITS | mm |
| 序号 No. | 变更内容 MODIFY CONTENT | 日期 MODIFY DATE | X.XXX ±0.10 | 投影 Projection | 材料 MATERIAL | | | | 页次 SHEET | 1/1 |
| | | | Angle ±3.0° | | | | | | | |

XD 深圳讯答科技有限公司
ShenzhenXundaTechnology Co.,Ltd

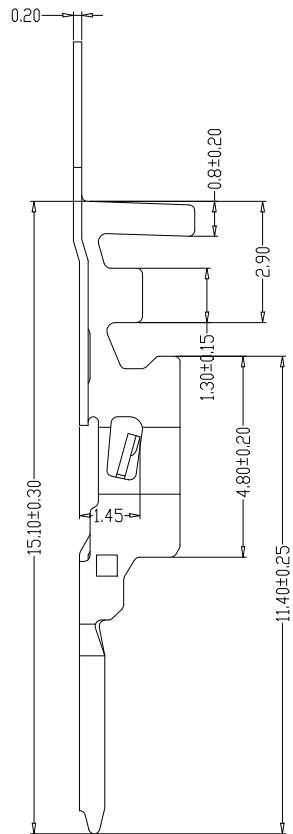
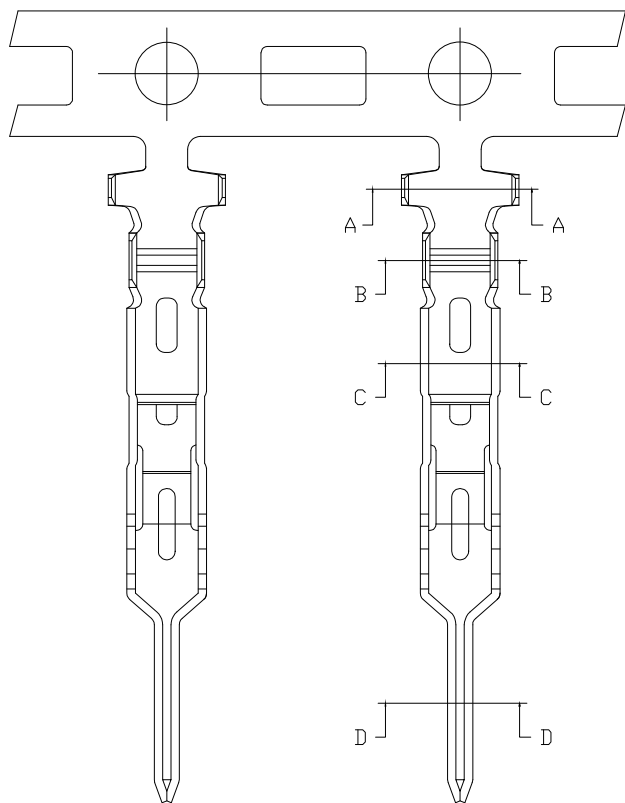

SPECIFICATIONS

- 1、 Current Rating: 3A AC, DC
- 2、 Voltage Rating: 250V AC, DC
- 3、 Temperature Range: -25°C~ +85°C
- 4、 Contact Resistance: 20mΩ Max
- 5、 Insulation Resistance: 1000mΩ Min
- 6、 Withstanding Voltage: 1500V AC/minute
- 7、 Material: Phosphoric bronze Tin-plated
- 8、 Applicable Wire Sizes: AWG #20~28#

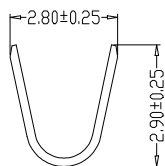

SEC: A-A

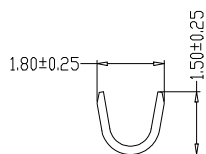

SEC: B-B

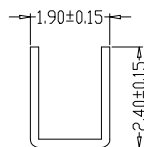

SEC: C-C

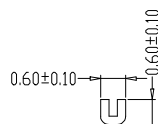

SEC: D-D

| | | | | | | | | | |
|-----------|------------------------|-------------------|-------------------|------------------|----|---|----------|-------------|---------------|
| | | | GENERAL TOLERANCE | 制图 DRAWING | 01 | 深圳讯答科技有限公司 ShenzhenXundaTechnology Co.,Ltd | | | |
| | | | DIM TOL | 审核 CHECK | | | | | 产品名称 TITLE |
| | | | X.X ±0.30 | 批准 APPROVAL | | 产品料号 PART NO. | XD-XA-PT | 单位 UNITS | mm |
| 1 | 初版发行 | | X.XX ±0.20 | 投影 Projection | | 材料 MATERIAL | | 页次 SHEET | 1/1 |
| 序号 No. | 变更内容 MODIFY CONTENT | 日期 MODIFY DATE | X.XXX ±0.10 | | | | | | |
| | | | Angle ±3.0° | | | | | | |

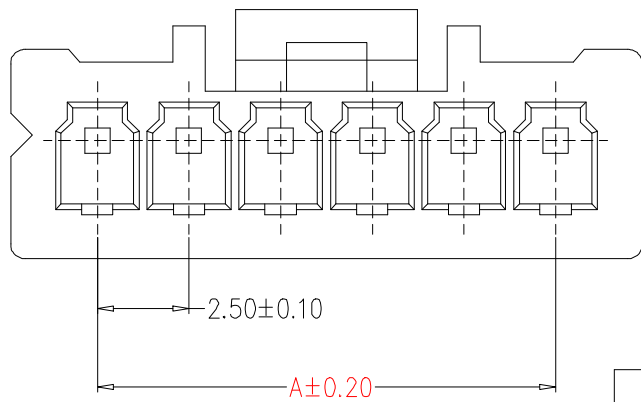
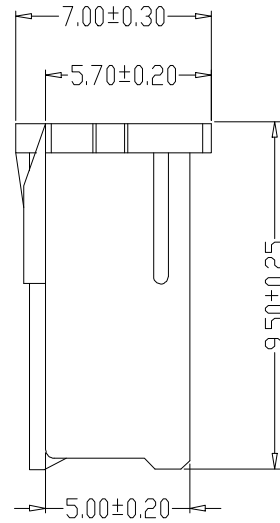
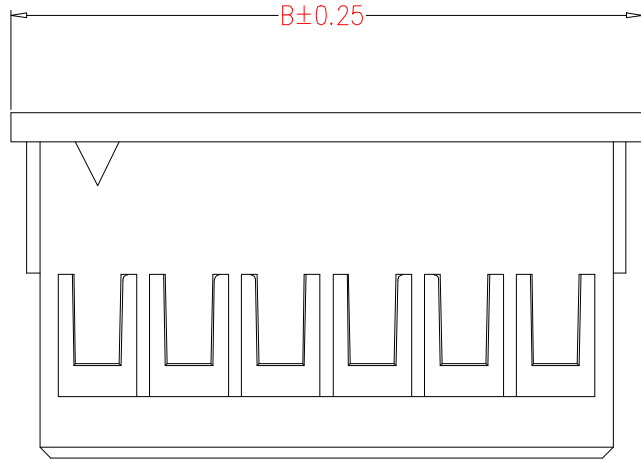

SPECIFICATIONS

- 1、 Current Rating: 3A AC, DC
- 2、 Voltage Rating: 250V AC, DC
- 3、 Temperature Range: -25°C~ +85°C
- 4、 Contact Resistance: 20mΩ Max
- 5、 Insulation Resistance: 1000mΩ Min
- 6、 Withstanding Voltage: 1000V AC/minute
- 7、 Material: Housing: Nylon66

| Circuit | Part NO. | Dimensions mm | |
|---------|-----------|---------------|-------|
| | | A | B |
| 2 | XD-XA-2Y | 2.50 | 7.50 |
| 3 | XD-XA-3Y | 5.00 | 10.00 |
| 4 | XD-XA-4Y | 7.50 | 12.50 |
| 5 | XD-XA-5Y | 10.00 | 15.00 |
| 6 | XD-XA-6Y | 12.50 | 17.50 |
| 7 | XD-XA-7Y | 15.00 | 20.00 |
| 8 | XD-XA-8Y | 17.50 | 22.50 |
| 9 | XD-XA-9Y | 20.00 | 25.00 |
| 10 | XD-XA-10Y | 22.50 | 27.50 |
| 11 | XD-XA-11Y | 25.00 | 30.00 |
| 12 | XD-XA-12Y | 27.50 | 32.50 |
| 13 | XD-XA-13Y | 30.00 | 35.00 |
| 14 | XD-XA-14Y | 32.50 | 37.50 |
| 15 | XD-XA-15Y | 35.00 | 40.00 |
| 16 | XD-XA-16Y | 37.50 | 42.50 |

Ordering Information

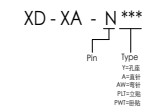

| | | | | | | | | | |
|-----------|------------------------|-------------------|-------------------|------------------|----|--|----------|-------------|---------------|
| | | | GENERAL TOLERANCE | 制图 DRAWING | 01 | 深圳讯答科技有限公司 Shenzhen Xunda Technology Co., Ltd | | | |
| | | | DIM TOL | 审核 CHECK | | | | | 产品名称 TITLE |
| | | | X.X ±0.30 | 批准 APPROVAL | | 产品料号 PART NO. | XD-XA-NY | 单位 UNITS | mm |
| | | | X.XX ±0.20 | 比例 SCALE | | 材料 MATERIAL | | 页次 SHEET | 1/1 |
| | | | X.XXX ±0.10 | 投影 Projection | | | | | |
| | | | Angle ±3.0° | | | | | | |
| 序号 No. | 变更内容 MODIFY CONTENT | 日期 MODIFY DATE | | | | | | | |

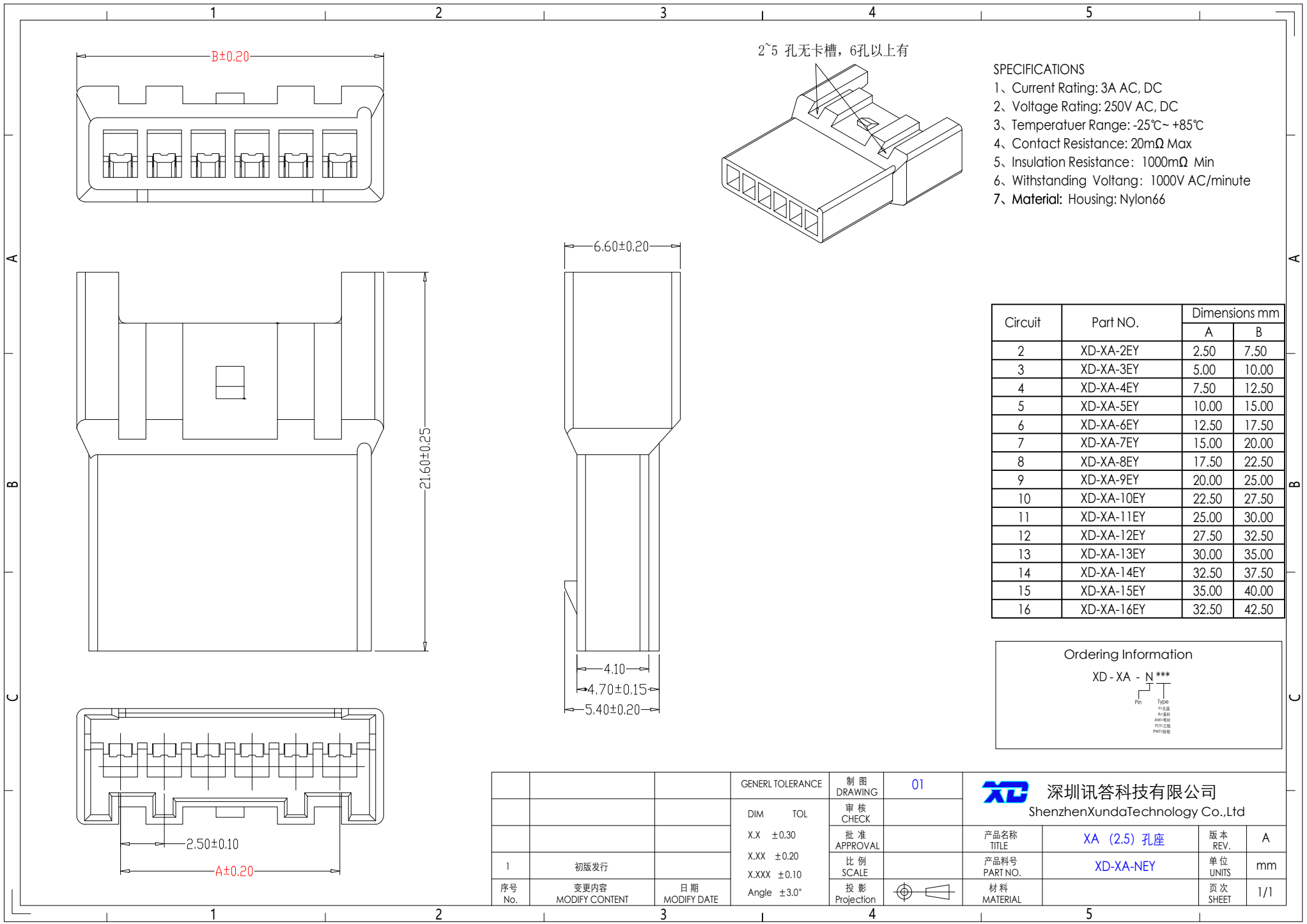

- SPECIFICATIONS**
- 1、Current Rating: 3A AC, DC
 - 2、Voltage Rating: 250V AC, DC
 - 3、Temperatuer Range: -25°C~ +85°C
 - 4、Contact Resistance: 20mΩ Max
 - 5、Insulation Resistance: 1000mΩ Min
 - 6、Withstanding Voltang: 1000V AC/minute
 - 7、Material: Housing: Nylon66

| Circuit | Part NO. | Dimensions mm | |
|---------|------------|---------------|-------|
| | | A | B |
| 2 | XD-XA-2EY | 2.50 | 7.50 |
| 3 | XD-XA-3EY | 5.00 | 10.00 |
| 4 | XD-XA-4EY | 7.50 | 12.50 |
| 5 | XD-XA-5EY | 10.00 | 15.00 |
| 6 | XD-XA-6EY | 12.50 | 17.50 |
| 7 | XD-XA-7EY | 15.00 | 20.00 |
| 8 | XD-XA-8EY | 17.50 | 22.50 |
| 9 | XD-XA-9EY | 20.00 | 25.00 |
| 10 | XD-XA-10EY | 22.50 | 27.50 |
| 11 | XD-XA-11EY | 25.00 | 30.00 |
| 12 | XD-XA-12EY | 27.50 | 32.50 |
| 13 | XD-XA-13EY | 30.00 | 35.00 |
| 14 | XD-XA-14EY | 32.50 | 37.50 |
| 15 | XD-XA-15EY | 35.00 | 40.00 |
| 16 | XD-XA-16EY | 32.50 | 42.50 |

Ordering Information

XD - XA - N ***

Pin Type
 N=间距
 A=间距
 A=间距
 A=间距
 P=间距

| | | | | | |
|-----------|------------------------|-------------------|------------------|------------------|----|
| | | | GENREL TOLERANCE | 制图 DRAWING | 01 |
| | | | DIM TOL | 审核 CHECK | |
| | | | X.X ±0.30 | 批准 APPROVAL | |
| | | | X.XX ±0.20 | 比例 SCALE | |
| | | | X.XXX ±0.10 | 投影 Projection | |
| | | | Angle ±3.0° | | |
| 1 | 初版发行 | | | | |
| 序号 No. | 变更内容 MODIFY CONTENT | 日期 MODIFY DATE | | | |

XD 深圳讯答科技有限公司
ShenzhenXundaTechnology Co.,Ltd

| | | | |
|------------------|-------------|-------------|-----|
| 产品名称 TITLE | XA (2.5) 孔座 | 版本 REV. | A |
| 产品料号 PART NO. | XD-XA-NEY | 单位 UNITS | mm |
| 材料 MATERIAL | | 页次 SHEET | 1/1 |

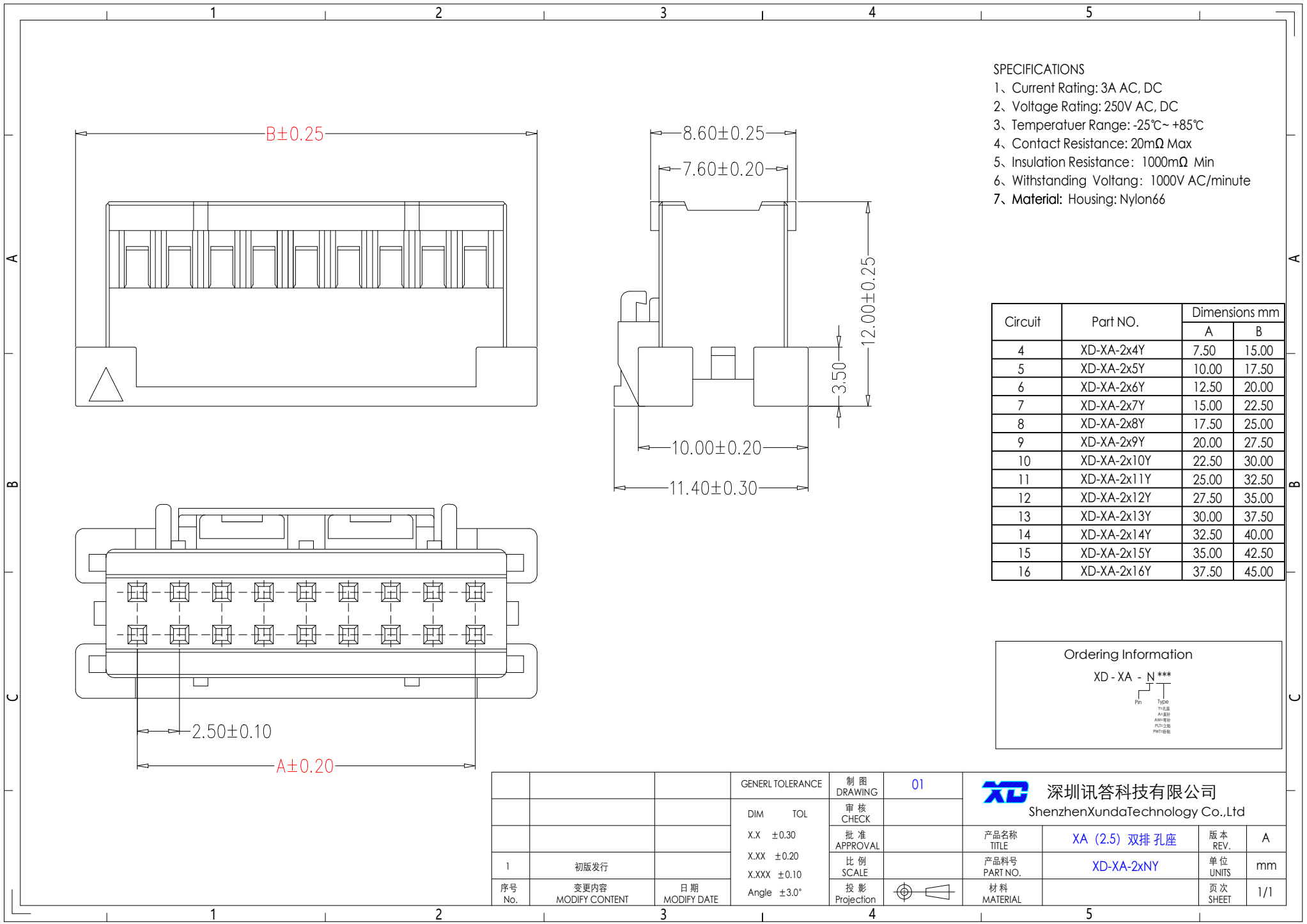

- SPECIFICATIONS**
- 1、Current Rating: 3A AC, DC
 - 2、Voltage Rating: 250V AC, DC
 - 3、Temperatuer Range: -25°C~ +85°C
 - 4、Contact Resistance: 20mΩ Max
 - 5、Insulation Resistance: 1000mΩ Min
 - 6、Withstanding Voltang: 1000V AC/minute
 - 7、Material: Housing: Nylon66

| Circuit | Part NO. | Dimensions mm | |
|---------|-------------|---------------|-------|
| | | A | B |
| 4 | XD-XA-2x4Y | 7.50 | 15.00 |
| 5 | XD-XA-2x5Y | 10.00 | 17.50 |
| 6 | XD-XA-2x6Y | 12.50 | 20.00 |
| 7 | XD-XA-2x7Y | 15.00 | 22.50 |
| 8 | XD-XA-2x8Y | 17.50 | 25.00 |
| 9 | XD-XA-2x9Y | 20.00 | 27.50 |
| 10 | XD-XA-2x10Y | 22.50 | 30.00 |
| 11 | XD-XA-2x11Y | 25.00 | 32.50 |
| 12 | XD-XA-2x12Y | 27.50 | 35.00 |
| 13 | XD-XA-2x13Y | 30.00 | 37.50 |
| 14 | XD-XA-2x14Y | 32.50 | 40.00 |
| 15 | XD-XA-2x15Y | 35.00 | 42.50 |
| 16 | XD-XA-2x16Y | 37.50 | 45.00 |

Ordering Information

XD - XA - N ***

Pin Type

 1=标准
 2=高脚
 3=带帽
 4=带帽
 5=带帽

| | | | | | | | | |
|-----------|------------------------|-------------------|------------------|----|---|---------------|-------------|-----|
| | | GENERAL TOLERANCE | 制图 DRAWING | 01 | 深圳讯答科技有限公司 ShenzhenXundaTechnology Co.,Ltd | | | |
| | | DIM TOL | 审核 CHECK | | | | | |
| | | X.X ±0.30 | 批准 APPROVAL | | 产品名称 TITLE | XA (2.5) 双排孔座 | 版本 REV. | A |
| | | X.XX ±0.20 | 比例 SCALE | | 产品料号 PART NO. | XD-XA-2xNY | 单位 UNITS | mm |
| | | X.XXX ±0.10 | 投影 Projection | | 材料 MATERIAL | | 页次 SHEET | 1/1 |
| | | Angle ±3.0° | | | | | | |
| 1 | 初版发行 | 日期 MODIFY DATE | | | | | | |
| 序号 No. | 变更内容 MODIFY CONTENT | 日期 MODIFY DATE | | | | | | |

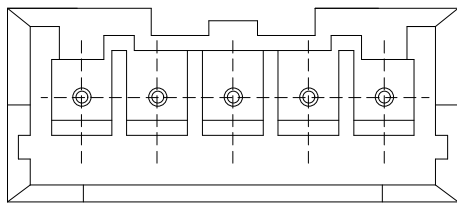
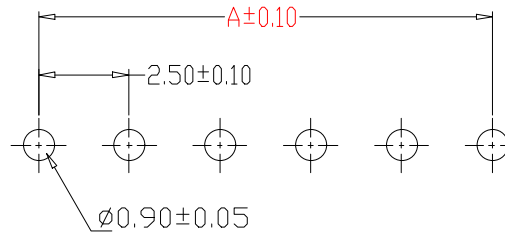
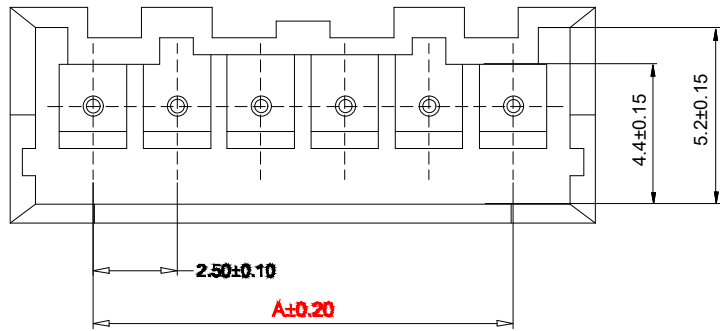
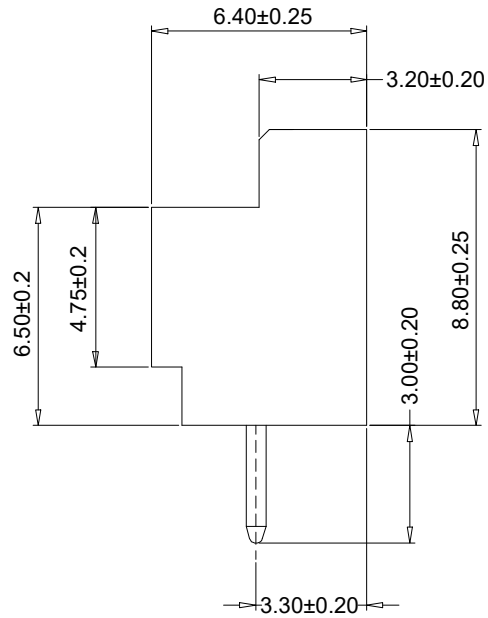
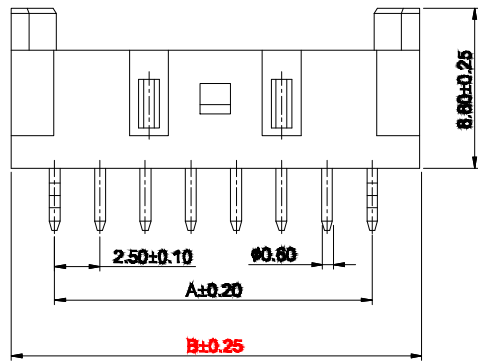

2~5A

SPECIFICATIONS

- 1、Current Rating: 3A AC, DC
- 2、Voltage Rating: 250V AC, DC
- 3、Temperatuer Range: -25°C~ +85°C
- 4、Contact Resistance: 20mΩ Max
- 5、Insulation Resistance: 1000mΩ Min
- 6、Withstanding Voltang: 1000V AC/minute
- 7、Material: Wafer Nylon66 UL94V-0
PIN Brass Tin-plated

| Circuit | Part NO. | Dimensions mm | |
|---------|-----------|---------------|-------|
| | | A | B |
| 2 | XD-XA-2A | 2.50 | 7.50 |
| 3 | XD-XA-3A | 5.00 | 10.00 |
| 4 | XD-XA-4A | 7.50 | 12.50 |
| 5 | XD-XA-5A | 10.00 | 15.00 |
| 6 | XD-XA-6A | 12.50 | 17.50 |
| 7 | XD-XA-7A | 15.00 | 20.00 |
| 8 | XD-XA-8A | 17.50 | 22.50 |
| 9 | XD-XA-9A | 20.00 | 25.00 |
| 10 | XD-XA-10A | 22.50 | 27.50 |
| 11 | XD-XA-11A | 25.00 | 30.00 |
| 12 | XD-XA-12A | 27.50 | 32.50 |
| 13 | XD-XA-13A | 30.00 | 35.00 |
| 14 | XD-XA-14A | 32.50 | 37.50 |
| 15 | XD-XA-15A | 35.00 | 40.00 |
| 16 | XD-XA-16A | 37.50 | 42.50 |

Ordering Information

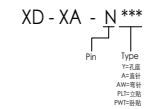

PCB LAYOUT

| GENERAL TOLERANCE | | | 制图 DRAWING | 01 | 深圳讯答科技有限公司 ShenzhenXundaTechnology Co.,Ltd | | | |
|-------------------|------------------------|-------------------|------------------|----|---|-------------|-------------|-----|
| | | | 审核 CHECK | | 产品名称 TITLE | XA (2.5) 直针 | 版本 REV. | A |
| | | | 批准 APPROVAL | | 产品料号 PART NO. | XD-XA-NA | 单位 UNITS | mm |
| 1 | 初版发行 | | 比例 SCALE | | 材料 MATERIAL | | 页次 SHEET | 1/1 |
| 序号 No. | 变更内容 MODIFY CONTENT | 日期 MODIFY DATE | 投影 Projection | | | | | |

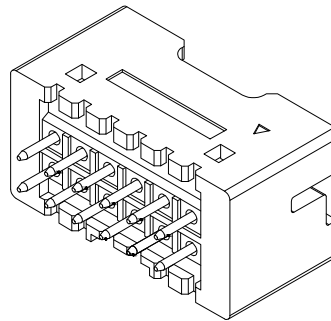
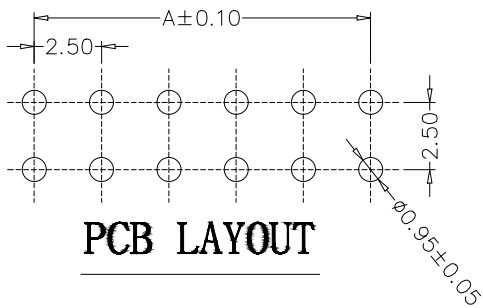
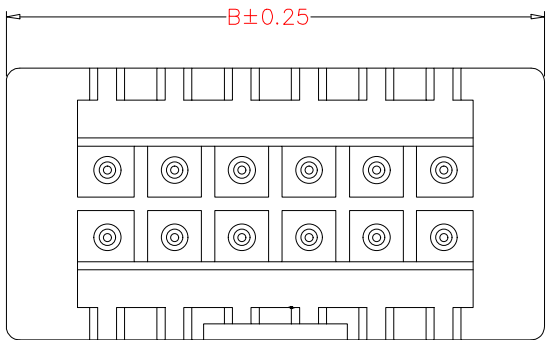

SPECIFICATIONS

- 1、 Current Rating: 3A AC, DC
- 2、 Voltage Rating: 250V AC, DC
- 3、 Temperatuer Range: -25°C~ +85°C
- 4、 Contact Resistance: 20mΩ Max
- 5、 Insulation Resistance: 1000mΩ Min
- 6、 Withstanding Voltang: 1000V AC/minute
- 7、 Material: Wafer Nylon66 UL94V-0
PIN Brass Tin-plated

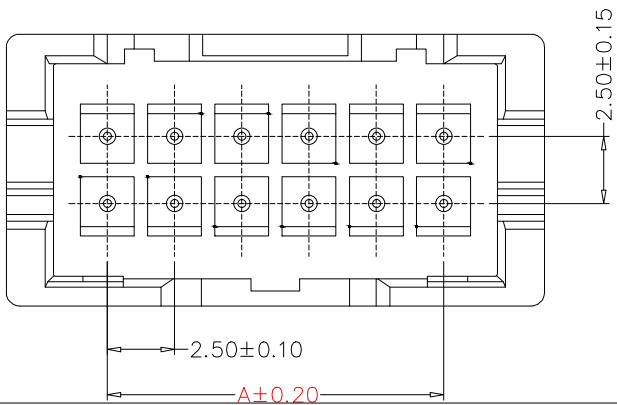
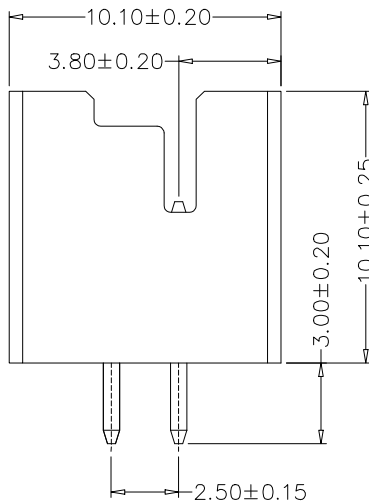
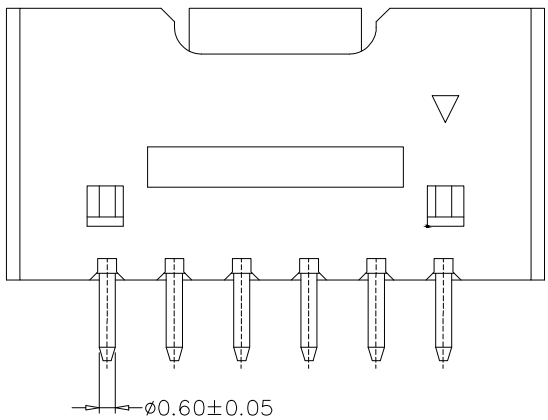

| Circuit | Part NO. | Dimensions mm | |
|---------|-------------|---------------|-------|
| | | A | B |
| 4 | XD-XA-2x4A | 7.50 | 15.00 |
| 5 | XD-XA-2x5A | 10.00 | 17.50 |
| 6 | XD-XA-2x6A | 12.50 | 20.00 |
| 7 | XD-XA-2x7A | 15.00 | 22.50 |
| 8 | XD-XA-2x8A | 17.50 | 25.00 |
| 9 | XD-XA-2x9A | 20.00 | 27.50 |
| 10 | XD-XA-2x10A | 22.50 | 30.00 |
| 11 | XD-XA-2x11A | 25.00 | 32.50 |
| 12 | XD-XA-2x12A | 27.50 | 35.00 |
| 13 | XD-XA-2x13A | 30.00 | 37.50 |
| 14 | XD-XA-2x14A | 32.50 | 40.00 |
| 15 | XD-XA-2x15A | 35.00 | 42.50 |
| 16 | XD-XA-2x16A | 37.50 | 45.00 |

Ordering Information

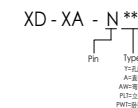

| | | | | | | | | |
|-----------|------------------------|-------------------|------------------|----|---|---------------|-------------|-----|
| | | GENERAL TOLERANCE | 制图 DRAWING | 01 | 深圳讯答科技有限公司 ShenzhenXundaTechnology Co.,Ltd | | | |
| | | DIM TOL | 审核 CHECK | | | | | |
| | | X.X ±0.30 | 批准 APPROVAL | | 产品名称 TITLE | XA (2.5) 双排直针 | 版本 REV. | A |
| | | X.XX ±0.20 | 比例 SCALE | | 产品料号 PART NO. | XD-XA-2xNA | 单位 UNITS | mm |
| | | X.XXX ±0.10 | 投影 Projection | | 材料 MATERIAL | | 页次 SHEET | 1/1 |
| 1 | 初版发行 | 日期 MODIFY DATE | | | | | | |
| 序号 No. | 变更内容 MODIFY CONTENT | 日期 MODIFY DATE | | | | | | |

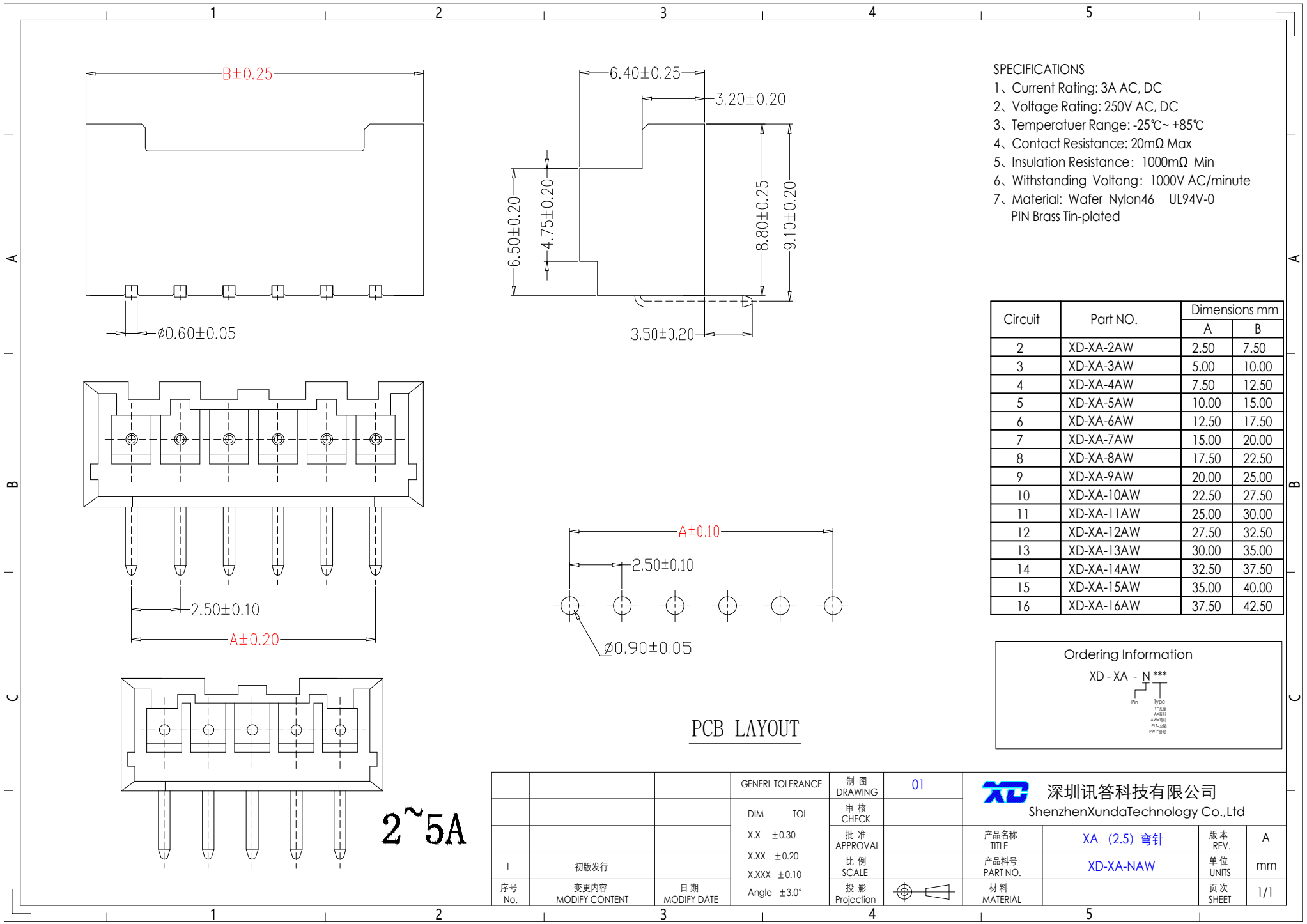

- SPECIFICATIONS
- 1、 Current Rating: 3A AC, DC
 - 2、 Voltage Rating: 250V AC, DC
 - 3、 Temperatuer Range: -25°C~ +85°C
 - 4、 Contact Resistance: 20mΩ Max
 - 5、 Insulation Resistance: 1000mΩ Min
 - 6、 Withstanding Voltang: 1000V AC/minute
 - 7、 Material: Wafer Nylon46 UL94V-0
PIN Brass Tin-plated

| Circuit | Part NO. | Dimensions mm | |
|---------|------------|---------------|-------|
| | | A | B |
| 2 | XD-XA-2AW | 2.50 | 7.50 |
| 3 | XD-XA-3AW | 5.00 | 10.00 |
| 4 | XD-XA-4AW | 7.50 | 12.50 |
| 5 | XD-XA-5AW | 10.00 | 15.00 |
| 6 | XD-XA-6AW | 12.50 | 17.50 |
| 7 | XD-XA-7AW | 15.00 | 20.00 |
| 8 | XD-XA-8AW | 17.50 | 22.50 |
| 9 | XD-XA-9AW | 20.00 | 25.00 |
| 10 | XD-XA-10AW | 22.50 | 27.50 |
| 11 | XD-XA-11AW | 25.00 | 30.00 |
| 12 | XD-XA-12AW | 27.50 | 32.50 |
| 13 | XD-XA-13AW | 30.00 | 35.00 |
| 14 | XD-XA-14AW | 32.50 | 37.50 |
| 15 | XD-XA-15AW | 35.00 | 40.00 |
| 16 | XD-XA-16AW | 37.50 | 42.50 |

Ordering Information

XD - XA - N ***

Pin Type
 N=尼龙
 AW=弯针
 P=平针
 PW=带盖

PCB LAYOUT

2~5A

| | | | | | | | | |
|-----------|------------------------|-------------------|------------------|----|---|-----------|-------------|---------------|
| | | GENERAL TOLERANCE | 制图 DRAWING | 01 | 深圳讯答科技有限公司 ShenzhenXundaTechnology Co.,Ltd | | | |
| | | DIM TOL | 审核 CHECK | | | | | 产品名称 TITLE |
| | | X.X ±0.30 | 批准 APPROVAL | | 产品料号 PART NO. | XD-XA-NAW | 单位 UNITS | mm |
| | | X.XX ±0.20 | 比例 SCALE | | 材料 MATERIAL | | 页次 SHEET | 1/1 |
| | | X.XXX ±0.10 | 投影 Projection | | | | | |
| 1 | 初版发行 | 日期 MODIFY DATE | | | | | | |
| 序号 No. | 变更内容 MODIFY CONTENT | 日期 MODIFY DATE | | | | | | |

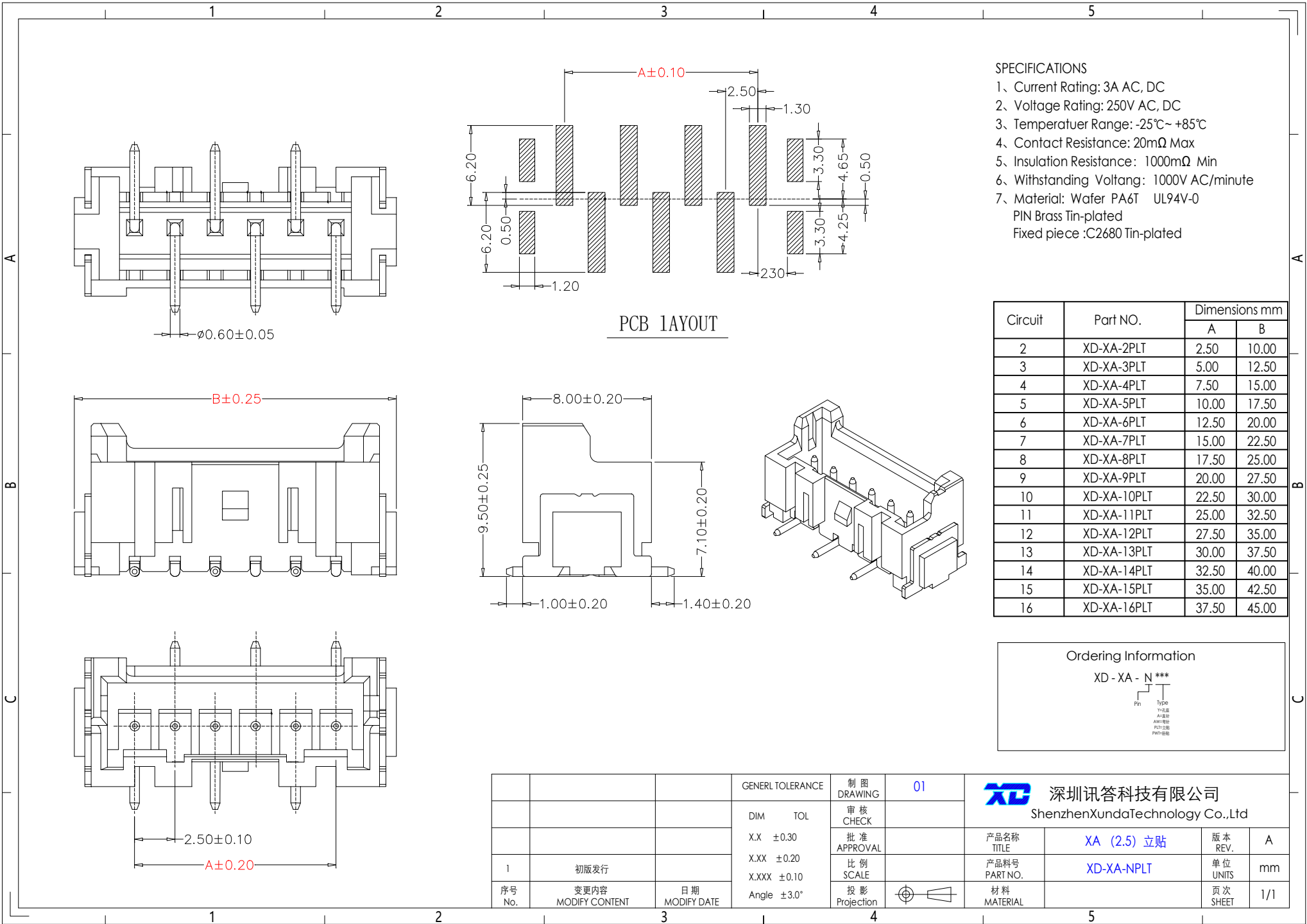

- SPECIFICATIONS**
- 1、 Current Rating: 3A AC, DC
 - 2、 Voltage Rating: 250V AC, DC
 - 3、 Temperatuer Range: -25°C~ +85°C
 - 4、 Contact Resistance: 20mΩ Max
 - 5、 Insulation Resistance: 1000mΩ Min
 - 6、 Withstanding Voltang: 1000V AC/minute
 - 7、 Material: Wafer PA6T UL94V-0
PIN Brass Tin-plated
Fixed piece :C2680 Tin-plated

| Circuit | Part NO. | Dimensions mm | |
|---------|-------------|---------------|-------|
| | | A | B |
| 2 | XD-XA-2PLT | 2.50 | 10.00 |
| 3 | XD-XA-3PLT | 5.00 | 12.50 |
| 4 | XD-XA-4PLT | 7.50 | 15.00 |
| 5 | XD-XA-5PLT | 10.00 | 17.50 |
| 6 | XD-XA-6PLT | 12.50 | 20.00 |
| 7 | XD-XA-7PLT | 15.00 | 22.50 |
| 8 | XD-XA-8PLT | 17.50 | 25.00 |
| 9 | XD-XA-9PLT | 20.00 | 27.50 |
| 10 | XD-XA-10PLT | 22.50 | 30.00 |
| 11 | XD-XA-11PLT | 25.00 | 32.50 |
| 12 | XD-XA-12PLT | 27.50 | 35.00 |
| 13 | XD-XA-13PLT | 30.00 | 37.50 |
| 14 | XD-XA-14PLT | 32.50 | 40.00 |
| 15 | XD-XA-15PLT | 35.00 | 42.50 |
| 16 | XD-XA-16PLT | 37.50 | 45.00 |

Ordering Information

XD - XA - N ***

Pin Type
 Y=任意
 A=铝基板
 AW=陶瓷
 P=PCB
 PW=树脂

| GENERAL TOLERANCE | | 制图 DRAWING | 01 |
|-------------------|-------|---------------|----|
| DIM | TOL | 审核 CHECK | |
| X.X | ±0.30 | 批准 APPROVAL | |
| X.XX | ±0.20 | 比例 SCALE | |
| X.XXX | ±0.10 | 投影 Projection | |
| Angle | ±3.0° | | |

XD 深圳讯答科技有限公司
ShenzhenXundaTechnology Co.,Ltd

| | | | |
|---------------|-------------|----------|-----|
| 产品名称 TITLE | XA (2.5) 立贴 | 版本 REV. | A |
| 产品料号 PART NO. | XD-XA-NPLT | 单位 UNITS | mm |
| 材料 MATERIAL | | 页次 SHEET | 1/1 |

| 序号 No. | 变更内容 MODIFY CONTENT | 日期 MODIFY DATE |
|--------|---------------------|----------------|
| 1 | 初版发行 | |

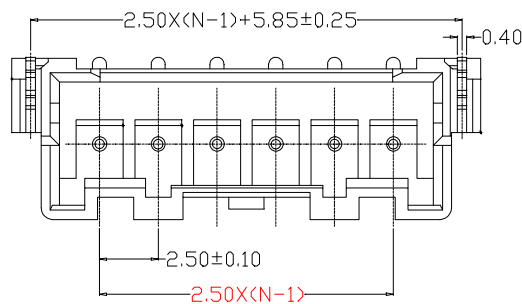
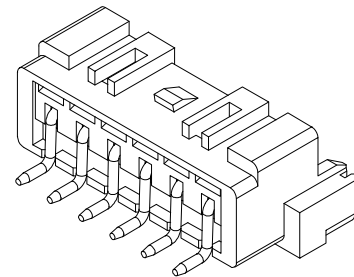
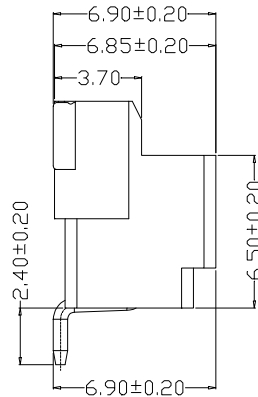
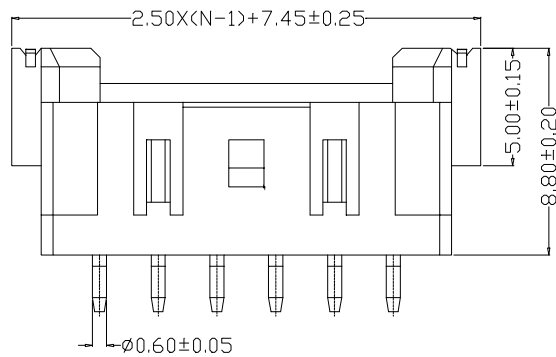
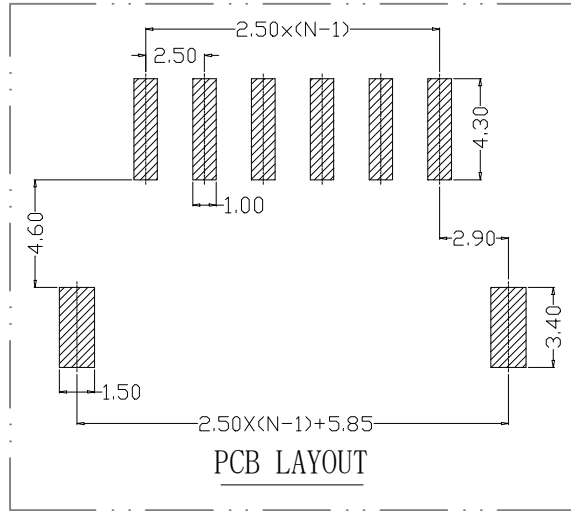
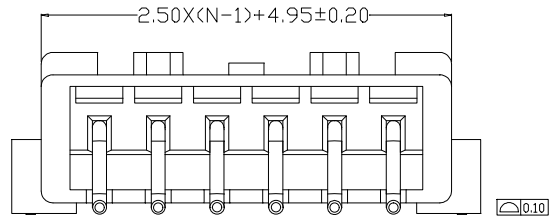

SPECIFICATIONS

- 1、 Current Rating: 3A AC, DC
- 2、 Voltage Rating: 250V AC, DC
- 3、 Temperatuer Range: -25°C~ +85°C
- 4、 Contact Resistance: 20mΩ Max
- 5、 Insulation Resistance: 1000mΩ Min
- 6、 Withstanding Voltang: 1000V AC/minute
- 7、 Material: PA6T UL94V-0
PIN : C2680 Tin-plated
Fixed piece: C2680 Tin-plated

| Circuit | Part NO. | Dimensions mm | |
|---------|-------------|---------------|-------|
| | | A | B |
| 2 | XD-XA-2PWT | 2.50 | 10.00 |
| 3 | XD-XA-3PWT | 5.00 | 12.50 |
| 4 | XD-XA-4PWT | 7.50 | 15.00 |
| 5 | XD-XA-5PWT | 10.00 | 17.50 |
| 6 | XD-XA-6PWT | 12.50 | 20.00 |
| 7 | XD-XA-7PWT | 15.00 | 22.50 |
| 8 | XD-XA-8PWT | 17.50 | 25.00 |
| 9 | XD-XA-9PWT | 20.00 | 27.50 |
| 10 | XD-XA-10PWT | 22.50 | 30.00 |
| 11 | XD-XA-11PWT | 25.00 | 32.50 |
| 12 | XD-XA-12PWT | 27.50 | 35.00 |
| 13 | XD-XA-13PWT | 30.00 | 37.50 |
| 14 | XD-XA-14PWT | 32.50 | 40.00 |
| 15 | XD-XA-15PWT | 35.00 | 42.50 |
| 16 | XD-XA-16PWT | 37.50 | 45.00 |

Ordering Information

XD - XA - N ***



| | | | GENERAL TOLERANCE | 制图 DRAWING | 01 | 深圳讯答科技有限公司 ShenzhenXundaTechnology Co.,Ltd | | | |
|-----------|------------------------|-------------------|-------------------|------------------|----|---|-------------|-------------|-----|
| | | | DIM TOL | 审核 CHECK | | 产品名称 TITLE | XA (2.5) 卧贴 | 版本 REV. | A |
| | | | X.X ±0.30 | 批准 APPROVAL | | 产品料号 PART NO. | XD-XA-NPWT | 单位 UNITS | mm |
| | | | X.XX ±0.20 | 比例 SCALE | | 材料 MATERIAL | | 页次 SHEET | 1/1 |
| | | | X.XXX ±0.10 | 投影 Projection | | | | | |
| | | | Angle ±3.0° | | | | | | |
| 1 | 初版发行 | | | | | | | | |
| 序号 No. | 变更内容 MODIFY CONTENT | 日期 MODIFY DATE | | | | | | | |

X-ON Electronics

Largest Supplier of Electrical and Electronic Components

Click to view similar products for [Headers & Wire Housings](#) category:

Click to view products by [chxunda](#) manufacturer:

Other Similar products are found below :

[0015917161](#) [0022155065](#) [57102-F02-18ULF](#) [58102-G61-06LF](#) [582553-1](#) [01.001.5753.1](#) [0050291907](#) [02.125.8002.8](#) [609-3404](#) [61062-3](#)
[CSU011177004](#) [622-0430](#) [622-3653LF](#) [63453-116](#) [636-1030](#) [636-1427](#) [636-3427](#) [636-4007](#) [641938-9](#) [65495-038](#) [65692-001LF](#) [65781-018](#)
[65781-047](#) [65817-010LF](#) [65817-015LF](#) [67095-007LF](#) [67601157](#) [68631-112](#) [68645-018](#) [699319-000](#) [70.362.1628.0](#) [70-4210](#) [70-4226B](#) [70-](#)
[4853B](#) [71.350.2428.0](#) [733-134](#) [733-162](#) [760-3052](#) [MHR-64-VUAL](#) [80.063.4001.1](#) [800-90-001-10-001000](#) [801-43-002-10-013000](#)
[801-43-006-10-002000](#) [803-43-024-10-001000](#) [803-93-012-10-001000](#) [8-1437020-4](#) [819-22-004-30-001101](#) [820-22-006-30-001101](#)
[820-22-008-30-001101](#) [821-22-002-10-001101](#)