

2023



深圳市讯答科技有限公司

线对板连接器 产品介绍

# 线对板连接器 产品目录

- 1 • 间距 PITCH: 0.8mm (5~6页)  
0.8单排条形连接器 XD-0.8 系列 (XXXX-SURS-TF)

- 2 • 间距 PITCH: 1.0mm (7~12页)  
1.0单排条形连接器 XD-1.0 系列 (XXX-SRSS-TB)  
1.0超薄条形连接器 XD-CB1.0 系列  
1.0普通带钩条形连接器 XD-G1.0 系列  
1.0双排条形连接器 XD-SHD 系列 (XX SHD系列)  
1.0双排条形连接器 XD-SHC 系列 (X-SHLDS-G-TF)

- 3 • 间距 PITCH: 1.25mm (13~20页)  
1.25单排条形连接器 XD-1.25 系列 (53261/53398)  
1.25超薄条形连接器 XD-CB1.25 系列 (53780)  
1.25双排条形连接器 XD-A1250 (DF13) 系列 (DF13)  
1.25带扣条形连接器 XD-GH 系列 (X-GHS-TB)  
1.25双排条形连接器 XD-GHD 系列  
1.25空中对接条形连接器 XD-1.25 系列

- 4 • 间距 PITCH: 1.5mm (21~25页)  
1.5单排条形连接器 XD-ZH 系列 (XX-ZR-SM4-TFT)  
1.5单排条形连接器 XD-ZE 系列 (XX-ZESS-TBT)  
1.5单排条形连接器 XD-ZA 系列 (87438/87438)

- 5 • 间距 PITCH: 2.0mm (26~39页)  
2.0单排条形连接器 XD-PH 系列 (PH)  
2.0双排条形连接器 XD-PHD 系列 (XX-PHDSS)  
2.0双排带扣条形连接器 XD-PHB 系列  
2.0单排条形连接器 XD-PA 系列  
2.0单排条形连接器 XD-PAE 系列 (XX-PA)  
2.0单排带扣条形连接器 XD-HY 系列 (YEONHO-20037-HNN)  
2.0单排带扣(加高)条形连接器 XD-HYH 系列  
2.0双排条形连接器 XD-SPH 系列 (XX-PADSS)  
2.0空中对接条形连接器 XD-PH 系列  
2.0空中对接条形连接器 XD-HY 系列  
2.0杜邦连接器 XD-2008 系列

# 线对板连接器 产品目录

## 6 • 间距 PITCH: 2.50mm (40~52页)

2.5单排条形连接器 XD-XH (TJC3) 系列 (XH)

2.5单排条形连接器 XD-XHB 系列

2.5双排条形连接器 XD-XHD 系列 (DF1B)

2.5单排(加高)条形连接器 XD-XHL 系列

2.5单排条形连接器 XD-XA 系列 (XX-XASS)

2.5单排条形连接器 XD-HA 系列

2.5单排条形连接器 XD-5264 系列

2.5双排条形连接器 XD-XAD 系列

2.54双排条形连接器 XD-2510 系列

2.54刺破条形连接器 XD-A2510 系列

## 7 • 间距 PITCH: 3.00mm (53~55页)

3.00双排条形连接器 XD-MX 系列 (43650)

## 8 • 间距 PITCH: 3.81mm (56~57页)

3.81单排条形连接器 XD-3.81 系列

## 9 • 间距 PITCH: 3.96mm (58~63页)

3.96单排条形连接器 XD-3.96 系列 (0965)

3.96单排条形连接器 XD-VH 系列 (VH)

3.96单排(加高)条形连接器 XD-VHL 系列 (BH2P-VH)

3.96单排(加高)条形连接器 XD-VHH

## 10 • 间距 PITCH: 4.20mm (64~67页)

4.20单、双排条形连接器 XD-5557 系列

4.20双排 防水条形连接器 XD-5557R 系列

## 11 • 间距 PITCH: 5.00mm (68~70页)

5.00单排条形连接器 XD-5003 系列 (XX-NV)

5.00单排条形连接器 XD-C2 系列

# 线对板连接器 产品目录

## 12 · 间距 PITCH: 5.08mm (71~76页)

- 5.08单排条形连接器 XD-5.08 系列
- 5.08单排条形连接器 XD-C5080 系列
- 5.08单排条形连接器 XD-5083 系列
- 5.08双排条形连接器 XD-5084 系列

## 13 · 间距 PITCH: 6.20mm (77~79页)

- 6.20单、双排条形连接器 XD-C6200 系列 (XX-VL)

## 14 · 间距 PITCH: 6.35mm (80~82页)

- 6.35单排条形连接器 XD-C6350 系列

## 15 · 间距 PITCH: 8.00mm (83~84页)

- 8.00单排条形连接器 XD-8001 系列

## 16 · 间距 PITCH: 10.16mm (85~88页)

- 10.16单排条形连接器 XD-10.16 系列
- 10.16双排条形连接器 XD-10.16 系列



# 0.8mm 系列

1

• 间距 PITCH: 0.8mm (5~6页)

0.8单排条形连接器 XD-0.8 系列

# 主要技术特征 MAIN SPECIFICATIONS

间距 Pitch: 0.8mm

线数 Poles: 2~16

适用线规 APPLICable Wire: AWG#32- #36

适用基板厚度 APPLICable PC board thickness: 0.6~1.2mm

温度范围 Temperatuer Range: -25°C~ +85°C

额定电压 Voltage Rating: 30V AC, DC

额定电流 Current Rating: 0.5A AC, DC

接触电阻 Contract Resistance: 30mΩ Max

绝缘电阻 Insulation Resistance: 100mΩ Min

耐压 Withstanding Voltang: 200V

# 材料 MATERIAL

端子 Terminal: Phosphor bronz

孔座 Housing: PA46 UL94V-0

针座 Wafer: LCP UL94V-0

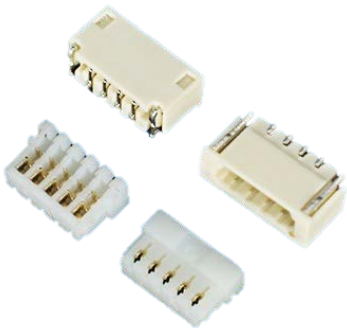

# XD-0.8 系列

Terminal XD-0.8-T

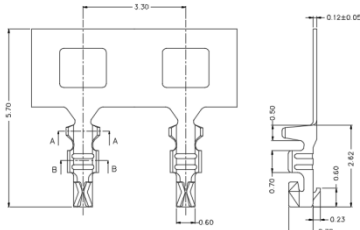

Housing XD-0.8-NY

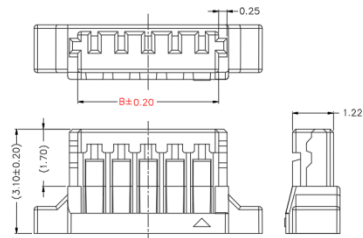

Wafer XD-0.8-NPLT

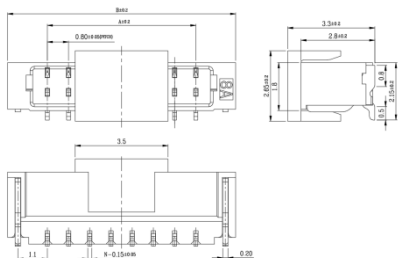

Wafer XD-0.8-NPWT

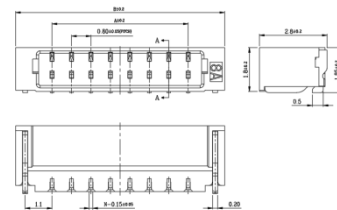

Housing

Wafer

型号Type-	尺寸(mm).		
	A.	B.	C.
XD-0.8-2Y.	0.20	1.80	4.40
XD-0.8-3Y.	1.40	2.60	5.20
XD-0.8-4Y.	2.40	3.40	6.00
XD-0.8-5Y.	3.20	4.20	6.80
XD-0.8-6Y.	4.00	5.00	7.60
XD-0.8-7Y.	4.80	5.80	8.40
XD-0.8-8Y.	5.60	6.60	9.20
XD-0.8-9Y.	6.40	7.40	10.00
XD-0.8-10Y.	7.20	8.20	10.80
XD-0.8-11Y.	8.00	9.00	11.60
XD-0.8-12Y.	8.80	9.80	12.40
XD-0.8-13Y.	9.60	10.60	13.20
XD-0.8-14Y.	10.40	11.40	14.00
XD-0.8-15Y.	11.20	12.20	14.80
XD-0.8-16Y.	12.00	13.00	15.60

型号Type-	尺寸(mm).	
	A.	B.
XD-0.8-2P/LT/PWT.	0.80	3.80
XD-0.8-3P/LT/PWT.	1.60	4.60
XD-0.8-4P/LT/PWT.	2.40	5.40
XD-0.8-5P/LT/PWT.	3.20	6.20
XD-0.8-6P/LT/PWT.	4.00	7.00
XD-0.8-7P/LT/PWT.	4.80	7.80
XD-0.8-8P/LT/PWT.	5.60	8.60
XD-0.8-9P/LT/PWT.	6.40	9.40
XD-0.8-10P/LT/PWT.	7.20	10.20
XD-0.8-11P/LT/PWT.	8.00	11.00
XD-0.8-12P/LT/PWT.	8.80	11.80
XD-0.8-13P/LT/PWT.	9.60	12.60
XD-0.8-14P/LT/PWT.	10.40	13.40
XD-0.8-15P/LT/PWT.	11.20	14.20
XD-0.8-16P/LT/PWT.	12.00	15.00

# 1.0mm 系列

2

- 间距 PITCH: 1.0mm (7~12页)

- 1.0单排条形连接器 XD-1.0 系列

- 1.0超薄条形连接器 XD-CB1.0 系列

- 1.0普通带钩条形连接器 XD-G1.0 系列

- 1.0双排条形连接器 XD-SHD 系列

- 1.0双排条形连接器 XD-SHC 系列

# 主要技术特征 MAIN SPECIFICATIONS

间距 Pitch: 1.0mm

线数 Poles: 2~16

适用线规 APPLICable Wire: AWG#28- #32

适用基板厚度 APPLICable PC board thickness: 0.6~1.2mm

温度范围 Temperatuer Range: -25°C~ +85°C

额定电压 Voltage Rating: 125V AC, DC

额定电流 Current Rating: 1A AC, DC

接触电阻 Contract Resistance: 20mΩ Max

绝缘电阻 Insulation Resistance: 100mΩ Min

耐压 Withstanding Voltang: 500V

# XD-1.0 系列

● Terminal

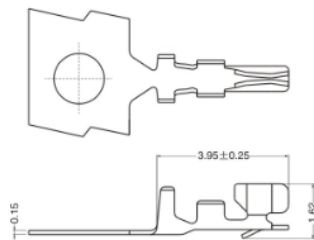

1.0-T

● Housing

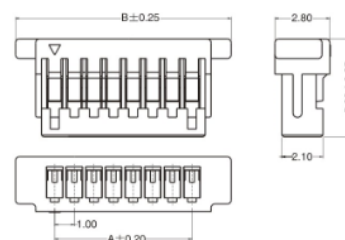

1.0-Y

● Wafer

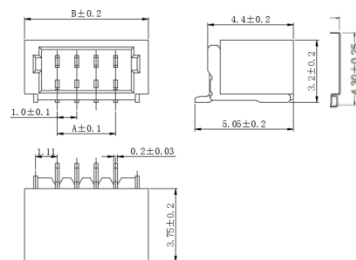

1.0(卧贴)

● Wafer

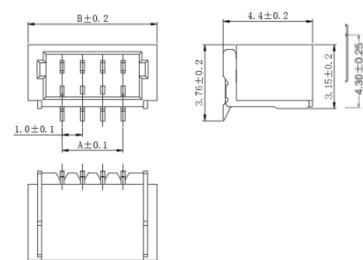

1.0(立贴)

# 材料 MATERIAL

端子 Terminal: Phosphor bronz

孔座 Housing: PBT UL94V-0

针座 Wafer: LCP UL94V-0

● Housing

型号Type <sup>①</sup>	尺寸(mm) <sup>②</sup>	
	A <sup>③</sup>	B <sup>④</sup>
XD-1.0-2Y <sup>⑤</sup>	1.00 <sup>⑥</sup>	5.00 <sup>⑦</sup>
XD-1.0-3Y <sup>⑤</sup>	2.00 <sup>⑥</sup>	6.00 <sup>⑦</sup>
XD-1.0-4Y <sup>⑤</sup>	3.00 <sup>⑥</sup>	7.00 <sup>⑦</sup>
XD-1.0-5Y <sup>⑤</sup>	4.00 <sup>⑥</sup>	8.00 <sup>⑦</sup>
XD-1.0-6Y <sup>⑤</sup>	5.00 <sup>⑥</sup>	9.00 <sup>⑦</sup>
XD-1.0-7Y <sup>⑤</sup>	6.00 <sup>⑥</sup>	10.00 <sup>⑦</sup>
XD-1.0-8Y <sup>⑤</sup>	7.00 <sup>⑥</sup>	11.00 <sup>⑦</sup>
XD-1.0-16Y <sup>⑤</sup>	15.00 <sup>⑥</sup>	19.00 <sup>⑦</sup>

● Wafer

型号Type <sup>①</sup>	尺寸(mm) <sup>②</sup>	
	A <sup>③</sup>	B <sup>④</sup>
XD-1.0-2PWT/LT <sup>⑤</sup>	1.00 <sup>⑥</sup>	4.30 <sup>⑦</sup>
XD-1.0-3PWT/LT <sup>⑤</sup>	2.00 <sup>⑥</sup>	5.30 <sup>⑦</sup>
XD-1.0-4PWT/LT <sup>⑤</sup>	3.00 <sup>⑥</sup>	6.30 <sup>⑦</sup>
XD-1.0-5PWT/LT <sup>⑤</sup>	4.00 <sup>⑥</sup>	7.30 <sup>⑦</sup>
XD-1.0-6PWT/LT <sup>⑤</sup>	5.00 <sup>⑥</sup>	8.30 <sup>⑦</sup>
XD-1.0-7PWT/LT <sup>⑤</sup>	6.00 <sup>⑥</sup>	9.30 <sup>⑦</sup>
XD-1.0-8PWT/LT <sup>⑤</sup>	7.00 <sup>⑥</sup>	10.30 <sup>⑦</sup>
XD-1.0-16PWT/LT <sup>⑤</sup>	15.00 <sup>⑥</sup>	18.30 <sup>⑦</sup>

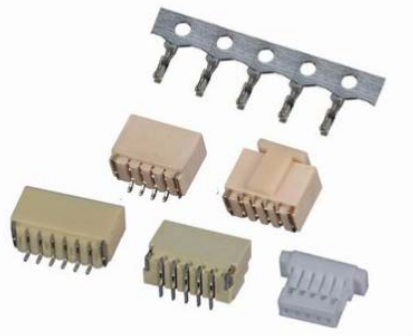

# 主要技术特征 MAIN SPECIFICATIONS

间距 Pitch: 1.0mm

线数 Poles: 2~20

适用线规 APPLICable Wire: AWG#28- #32

适用基板厚度 APPLICable PC board thickness: 0.6~1.2mm

温度范围 Temperatuer Range: -25°C~ +85°C

额定电压 Voltage Rating: 50V AC, DC

额定电流 Current Rating: 1A AC, DC

接触电阻 Contact Resistance: 20mΩ Max

绝缘电阻 Insulation Resistance: 100mΩ Min

耐压 Withstanding Voltang: 500V

# XD-CB1.0 超薄系列

● Terminal XD-CB1.0-T

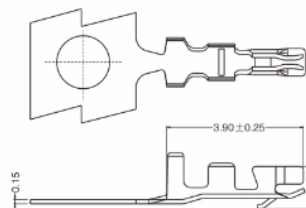

● Housing XD-CB1.0-NY

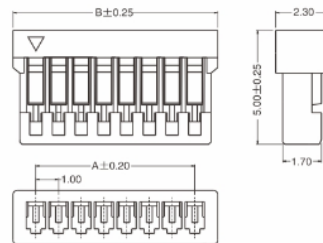

● Wafer XD-CB1.0-NPWT (卧贴)

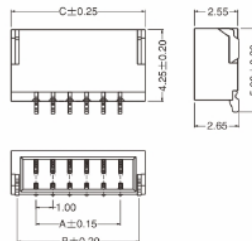

# 材料 MATERIAL

端子 Terminal: Phosphor bronz

孔座 Housing: PA66 UL94V-0

针座 Wafer: PA6T UL94V-0

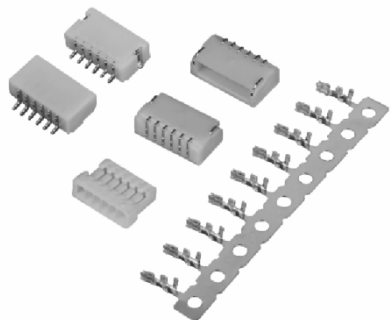

● Housing

型号Type	尺寸 (mm)		
	A	B	C
XD-CB1.0-2PWT	1.00	3.20	4.00
XD-CB1.0-3PWT	2.00	4.20	5.00
XD-CB1.0-4PWT	3.00	5.20	6.00
XD-CB1.0-5PWT	4.00	6.20	7.00
XD-CB1.0-6PWT	5.00	7.20	8.00
XD-CB1.0-7PWT	6.00	8.20	9.00
XD-CB1.0-8PWT	7.00	9.20	10.00
XD-CB1.0-20PWT	19.00	21.20	22.00

● Wafer

型号Type	尺寸 (mm)	
	A	B
XD-CB1.0-2Y	1.00	3.00
XD-CB1.0-3Y	2.00	4.00
XD-CB1.0-4Y	3.00	5.00
XD-CB1.0-5Y	4.00	6.00
XD-CB1.0-6Y	5.00	7.00
XD-CB1.0-7Y	6.00	8.00
XD-CB1.0-8Y	7.00	9.00
XD-CB1.0-20Y	19.00	21.00

# 主要技术特征 MAIN SPECIFICATIONS

间距 Pitch: 1.0mm

线数 Poles: 2~20

适用线规 APPLICable Wire: AWG#28- #32

适用基板厚度 APPLICable PC board thickness: 0.6~1.2mm

温度范围 Temperatuer Range: -25°C~ +85°C

额定电压 Voltage Rating: 50V AC, DC

额定电流 Current Rating: 1A AC, DC

接触电阻 Contract Resistance: 20mΩ Max

绝缘电阻 Insulation Resistance: 100mΩ Min

耐压 Withstanding Voltang: 500V

# 材料 MATERIAL

端子 Terminal: Phosphor bronz

孔座 Housing: PA66 UL94V-0

针座 Wafer: LCP UL94V-0



# XD-G1.0 带钩系列

## Terminal

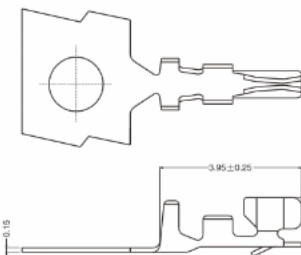

## G1.0带钩-T

## Housing

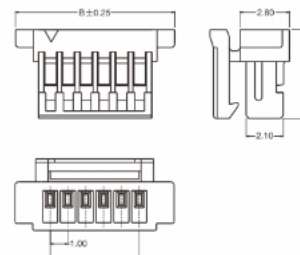

## G1.0带钩-Y

## Wafer

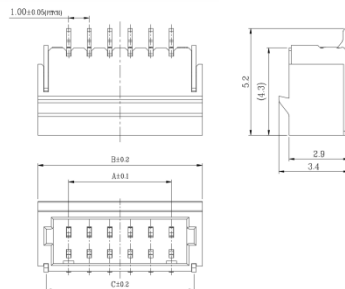

## G1.0带钩-PWT(卧贴)

## G1.0带钩-PLT(立贴)

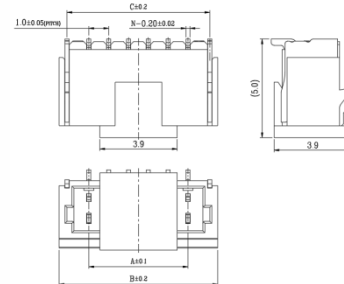

## Housing

型号Type	尺寸(mm)	
	A	B
XD-G1.0-2Y	1.00	5.00
XD-G1.0-3Y	2.00	6.00
XD-G1.0-4Y	3.00	7.00
XD-G1.0-5Y	4.00	8.00
XD-G1.0-6Y	5.00	9.00
XD-G1.0-20Y	19.00	23.00

## Wafer

型号Type	尺寸(mm)		
	A	B	C
XD-G1.0-2PWT/LT	1.00	4.00	3.20
XD-G1.0-3PWT/LT	2.00	5.00	4.20
XD-G1.0-4PWT/LT	3.00	6.00	5.20
XD-G1.0-5PWT/LT	4.00	7.00	6.20
XD-G1.0-6PWT/LT	5.00	8.00	7.20
XD-G1.0-20PWT/LT	19.00	22.00	21.20

## 主要技术特征 MAIN SPECIFICATIONS

间距 Pitch: 1.0mm

线数 Poles: 4~50

适用线规 APPLICable Wire: AWG#28

适用基板厚度 APPLICable PC board thickness: 0.6~1.2mm

温度范围 Temperatuer Range: -25°C~ +85°C

额定电压 Voltage Rating: 50V AC, DC

额定电流 Current Rating: 1A AC, DC

接触电阻 Contact Resistance: 20mΩ Max

绝缘电阻 Insulation Resistance: 100mΩ Min

耐压 Withstanding Voltang: 500V

## 材料 MATERIAL

针座 Wafer: LCP UL94V-0

## XD-SHD1.0 双排系列

### ● Wafer

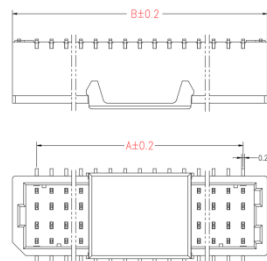

### SHD-PLT(立贴)

### ● Wafer

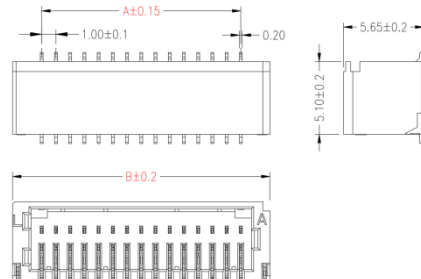

### SHD-PWT(卧贴)

### ● Wafer

型号Type.	尺寸(mm).	
	A.	B.
XD-SHD-2x2PLT-G-04.	1.00.	4.30.
XD-SHD-2x3PLT-G-04.	2.00.	5.30.
XD-SHD-2x4PLT-G-04.	3.00.	6.30.
XD-SHD-2x5PLT-G-04.	4.00.	7.30.
XD-SHD-2x6PLT-G-04.	5.00.	8.30.
XD-SHD-2x25PLT-G-04.	24.00.	27.30.

### ● Wafer

型号Type.	尺寸(mm).	
	A.	B.
XD-SHD-2x5PWT-G-04.	4.00.	8.10.
XD-SHD-2x6PWT-G-04.	5.00.	9.10.
XD-SHD-2x7PWT-G-04.	6.00.	10.10.
XD-SHD-2x8PWT-G-04.	7.00.	12.10.
XD-SHD-2x9PWT-G-04.	8.00.	13.10.
XD-SHD-2x25PWT-G-04.	24.00.	28.10.

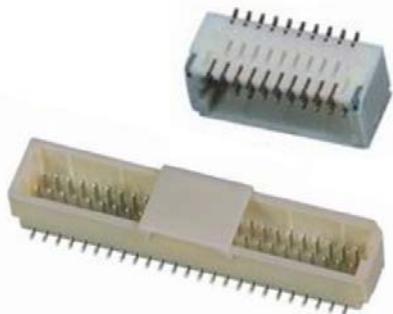

# 主要技术特征 MAIN SPECIFICATIONS

间距 Pitch: 1.0mm

线数 Poles: 4~50

适用线规 APPLICable Wire: AWG#28- #32

适用基板厚度 APPLICable PC board thickness: 0.6~1.2mm

温度范围 Temperatuer Range: -25°C~ +85°C

额定电压 Voltage Rating: 50V AC, DC

额定电流 Current Rating: 1A AC, DC

接触电阻 Contract Resistance: 30mΩ Max

绝缘电阻 Insulation Resistance: 100mΩ Min

耐压 Withstanding Voltang: 500V

# XD-SHC1.0 双排系列

## Terminal XD-SHC-T

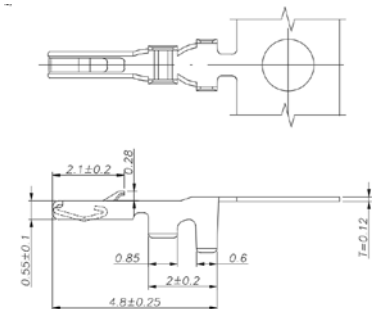

## Housing XD-SHC-2xNY

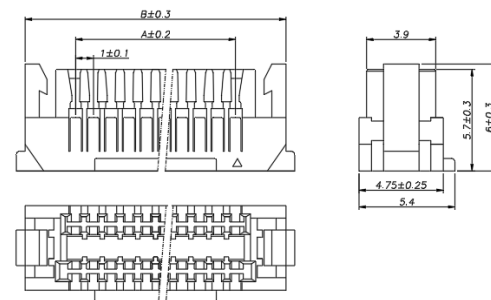

## Wafer XD-SHC-2xNPLT(立贴)

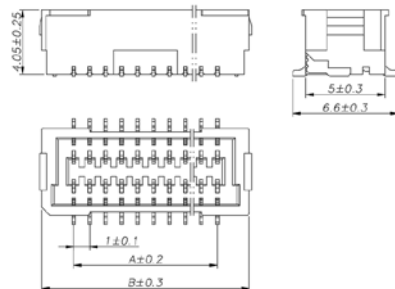

## Wafer XD-SHC-2xNPWT(卧贴)

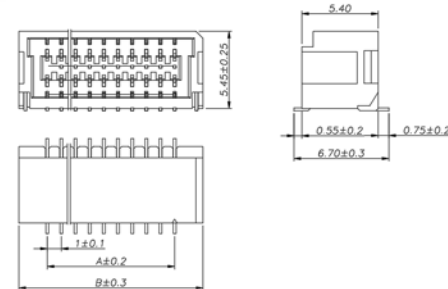

## Housing

型号Type	尺寸(mm)	
	A	B
XD-SHC-2x2Y	1.00	6.70
XD-SHC-2x3Y	2.00	7.70
XD-SHC-2x4Y	3.00	8.70
XD-SHC-2x5Y	4.00	9.70
XD-SHC-2x6Y	5.00	10.70
XD-SHC-2x7Y	6.00	11.70
XD-SHC-2x8Y	7.00	12.70
XD-SHC-2x30Y	29.00	34.70

## Wafer

型号Type	尺寸(mm)	
	A	B
XD-SHC-2x2PLT/PWT	1.00	5.00/5.50
XD-SHC-2x3PLT/PWT	2.00	6.00/6.50
XD-SHC-2x4PLT/PWT	3.00	7.00/7.50
XD-SHC-2x5PLT/PWT	4.00	8.00/8.50
XD-SHC-2x6PLT/PWT	5.00	9.00/9.50
XD-SHC-2x7PLT/PWT	6.00	10.00/10.50
XD-SHC-2x8PLT/PWT	7.00	11.00/11.50
XD-SHC-2x30PLT/PWT	29.00	33.00/33.50

# 材料 MATERIAL

端子 Terminal: Phosphor bronz

孔座 Housing: PA66 UL94V-0

针座 Wafer: PA66 UL94V-0

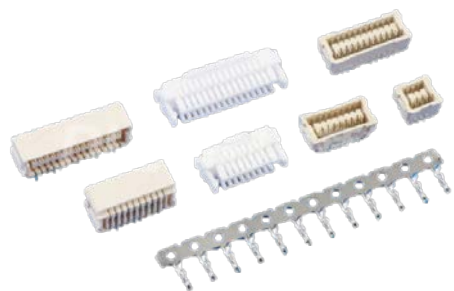



# 1.25mm 系列

3

- 间距 PITCH: 1.25mm (13~20页)

- 1.25单排条形连接器 XD-1.25 系列

- 1.25超薄条形连接器 XD-CB1.25 系列

- 1.25双排条形连接器 XD-A1250 (DF13) 系列

- 1.25带扣条形连接器 XD-GH1.25 系列

- 1.25空中对接条形连接器 XD-1.25 系列

## 主要技术特征 MAIN SPECIFICATIONS

间距 Pitch: 1.25mm

线数 Poles: 2~16

适用线规 APPLICable Wire: AWG#28- #32

适用基板厚度 APPLICable PC board thickness: 0.6~1.2mm

温度范围 Temperatuer Range: -25°C~ +85°C

额定电压 Voltage Rating: 125V AC, DC

额定电流 Current Rating: 1A AC, DC

接触电阻 Contract Resistance: 20mΩ Max

绝缘电阻 Insulation Resistance: 100mΩ Min

耐压 Withstanding Voltang: 500V

## 材料 MATERIAL

端子 Terminal: Phosphor bronz

孔座 Housing: Nylon66 UL94V-0

针座 Wafer: Nylon46 UL94V-0

针座(立/卧贴) Wafer: LCP UL94V-0



## XD-1.25 系列 (1)

● Terminal

XD-1.25-T

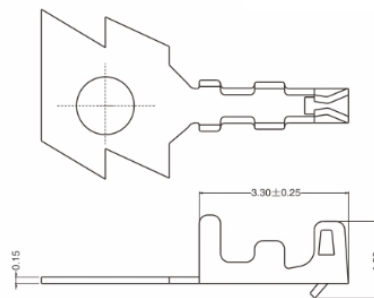

● Housing

XD-1.25-NY

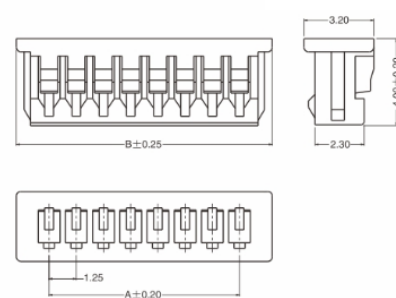

● Wafer

XD-1.25-NA

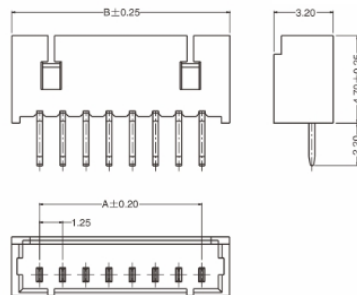

● Wafer

XD-1.25-NAW

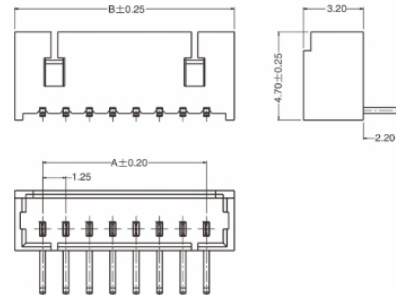

## 主要技术特征 MAIN SPECIFICATIONS

间距 Pitch: 1.25mm

线数 Poles: 2~16

适用线规 APPLICable Wire: AWG#28- #32

适用基板厚度 APPLICable PC board thickness: 0.6~1.2mm

温度范围 Temperatuer Range: -25°C~ +85°C

额定电压 Voltage Rating: 125V AC, DC

额定电流 Current Rating: 1A AC, DC

接触电阻 Contract Resistance: 20mΩ Max

绝缘电阻 Insulation Resistance: 100mΩ Min

耐压 Withstanding Voltang: 500V

## XD-1.25 系列 (2)

● Wafer

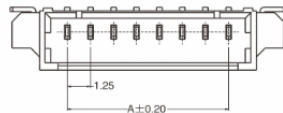
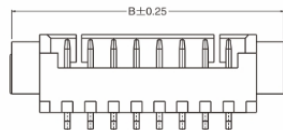

XD-1.25-NPWT

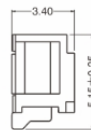

● Wafer

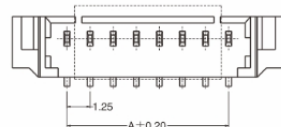
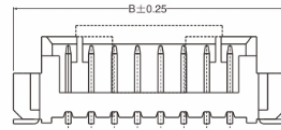

XD-1.25-NPLT

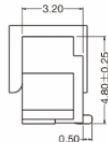

## 材料 MATERIAL

端子 Terminal: Phosphor bronz

孔座 Housing: Nylon66 UL94V-0

针座 Wafer: Nylon46 UL94V-0

针座(立/卧贴) Wafer: LCP UL94V-0



Housing

型号Type	尺寸(mm)	
	A	B
XD-1.25-2Y	1.25	4.25
XD-1.25-3Y	2.50	5.50
XD-1.25-4Y	3.75	6.75
XD-1.25-5Y	5.00	8.00
XD-1.25-6Y	6.25	9.25
XD-1.25-7Y	7.50	10.50
XD-1.25-8Y	8.75	11.75
XD-1.25-9Y	10.00	13.00
XD-1.25-10Y	11.25	14.25
XD-1.25-11Y	12.50	15.50
XD-1.25-12Y	13.75	16.75
XD-1.25-13Y	15.00	18.00
XD-1.25-14Y	16.25	19.25
XD-1.25-15Y	17.50	20.50
XD-1.25-20Y	23.75	26.75

Wafer

型号Type	尺寸(mm)	
	A	B
XD-1.25-2A/AW	1.25	4.25
XD-1.25-3A/AW	2.50	5.50
XD-1.25-4A/AW	3.75	6.75
XD-1.25-5A/AW	5.00	8.00
XD-1.25-6A/AW	6.25	9.25
XD-1.25-7A/AW	7.50	10.50
XD-1.25-8A/AW	8.75	11.75
XD-1.25-9A/AW	10.00	13.00
XD-1.25-10A/AW	11.25	14.25
XD-1.25-11A/AW	12.50	15.50
XD-1.25-12A/AW	13.75	16.75
XD-1.25-13A/AW	15.00	18.00
XD-1.25-14A/AW	16.25	19.25
XD-1.25-15A/AW	17.50	20.50
XD-1.25-20A/AW	23.75	26.75

Wafer

型号Type	尺寸(mm)	
	A	B
XD-1.25-2PWT/LT	1.25	7.35
XD-1.25-3PWT/LT	2.50	8.60
XD-1.25-4PWT/LT	3.75	9.85
XD-1.25-5PWT/LT	5.00	11.10
XD-1.25-6PWT/LT	6.25	12.35
XD-1.25-7PWT/LT	7.50	13.60
XD-1.25-8PWT/LT	8.75	14.85
XD-1.25-9PWT/LT	10.00	16.10
XD-1.25-10PWT/LT	11.25	17.35
XD-1.25-11PWT/LT	12.50	18.60
XD-1.25-12PWT/LT	13.75	19.85
XD-1.25-13PWT/LT	15.00	21.10
XD-1.25-14PWT/LT	16.25	22.35
XD-1.25-15PWT/LT	17.50	23.60
XD-1.25-20PWT/LT	23.75	29.85

# 主要技术特征 MAIN SPECIFICATIONS

间距 Pitch: 1.25mm

线数 Poles: 2~30

适用线规 APPLICable Wire: AWG#28- #32

适用基板厚度 APPLICable PC board thickness: 0.6~1.2mm

温度范围 Temperatuer Range: -25°C~ +85°C

额定电压 Voltage Rating: 125V AC, DC

额定电流 Current Rating: 1A AC, DC

接触电阻 Contact Resistance: 20mΩ Max

绝缘电阻 Insulation Resistance: 100mΩ Min

耐压 Withstanding Voltang: 500V

# XD-CB1.25 系列

● Terminal

XD-CB1.25-NT

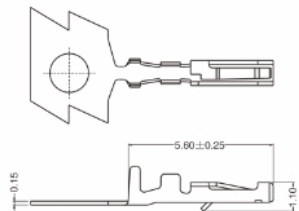

● Housing

XD-CB1.25-NY

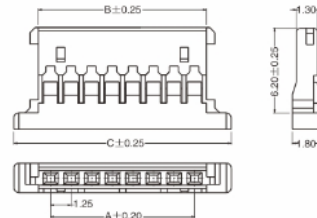

● Wafer

XD-CB1.25-NAWT

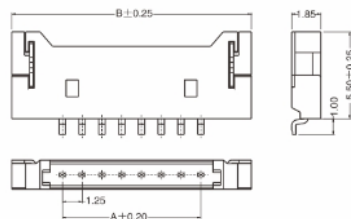

# 材料 MATERIAL

端子 Terminal: Phosphor bronz

孔座 Housing: PBT UL94V-0

针座 Wafer: Nylon6T UL94V-0

● Housing

型号 Type <sup>o</sup>	尺寸 (mm) <sup>o</sup>		
	A <sup>o</sup>	B <sup>o</sup>	C <sup>o</sup>
XD-CB1.25-2Y <sup>o</sup>	1.25 <sup>o</sup>	2.72 <sup>o</sup>	5.72 <sup>o</sup>
XD-CB1.25-3Y <sup>o</sup>	2.50 <sup>o</sup>	3.97 <sup>o</sup>	6.97 <sup>o</sup>
XD-CB1.25-4Y <sup>o</sup>	3.75 <sup>o</sup>	5.22 <sup>o</sup>	8.22 <sup>o</sup>
XD-CB1.25-5Y <sup>o</sup>	5.00 <sup>o</sup>	6.47 <sup>o</sup>	9.47 <sup>o</sup>
XD-CB1.25-6Y <sup>o</sup>	6.25 <sup>o</sup>	7.72 <sup>o</sup>	10.72 <sup>o</sup>
XD-CB1.25-7Y <sup>o</sup>	7.50 <sup>o</sup>	8.97 <sup>o</sup>	11.97 <sup>o</sup>
XD-CB1.25-8Y <sup>o</sup>	8.75 <sup>o</sup>	10.22 <sup>o</sup>	13.22 <sup>o</sup>
XD-CB1.25-30Y <sup>o</sup>	36.25 <sup>o</sup>	37.72 <sup>o</sup>	40.72 <sup>o</sup>

● Wafer

型号 Type <sup>o</sup>	尺寸 (mm) <sup>o</sup>	
	A <sup>o</sup>	B <sup>o</sup>
XD-CB1.25-2AWT <sup>o</sup>	1.25 <sup>o</sup>	7.65 <sup>o</sup>
XD-CB1.25-3AWT <sup>o</sup>	2.50 <sup>o</sup>	8.90 <sup>o</sup>
XD-CB1.25-4AWT <sup>o</sup>	3.75 <sup>o</sup>	10.15 <sup>o</sup>
XD-CB1.25-5AWT <sup>o</sup>	5.00 <sup>o</sup>	11.40 <sup>o</sup>
XD-CB1.25-6AWT <sup>o</sup>	6.25 <sup>o</sup>	12.65 <sup>o</sup>
XD-CB1.25-7AWT <sup>o</sup>	7.50 <sup>o</sup>	13.90 <sup>o</sup>
XD-CB1.25-8AWT <sup>o</sup>	8.75 <sup>o</sup>	15.15 <sup>o</sup>
XD-CB1.25-30AWT <sup>o</sup>	36.25 <sup>o</sup>	42.65 <sup>o</sup>

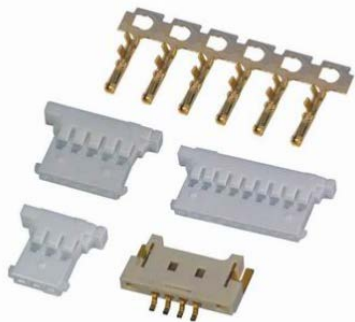

# 主要技术特征 MAIN SPECIFICATIONS

间距 Pitch: 1.25mm

线数 Poles: 2~40

适用线规 APPLICable Wire: AWG#28- #32

适用基板厚度 APPLICable PC board thickness: 0.6~1.2mm

温度范围 Temperatuer Range: -25°C~ +85°C

额定电压 Voltage Rating: 150V AC, DC

额定电流 Current Rating: 1A AC, DC

接触电阻 Contract Resistance: 20mΩ Max

绝缘电阻 Insulation Resistance: 500mΩ Min

耐压 Withstanding Voltang: 500V

# XD-A1250 (DF13)系列

● Terminal

XD-A1250-T

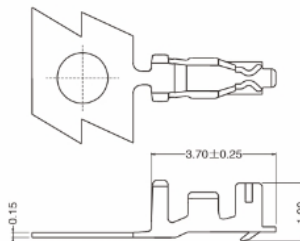

● Housing

XD-A1250-NY

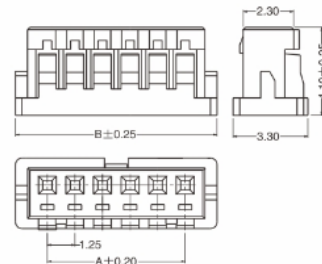

● Housing

XD-A1250-2xNY

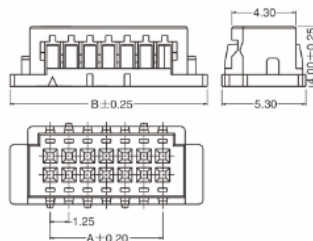

● Wafer

XD-A1250-2xNPLT

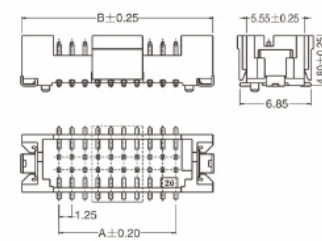

# 材料 MATERIAL

端子 Terminal: Phosphor bronz

孔座 Housing: Nylon66 UL94V-0

针座 Wafer: Nylon46 UL94V-0

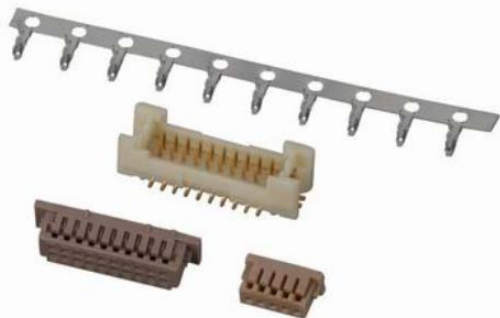

● Housing/Wafer

型号Type.	尺寸(mm).	
	A-	B-
XD-A1250-2Y.	1.25.	4.15.
XD-A1250-3Y.	2.50.	5.40.
XD-A1250-4Y.	3.75.	6.65.
XD-A1250-5Y.	5.00.	7.90.
XD-A1250-6Y.	6.25.	9.15.
XD-A1250-7Y.	7.50.	10.40.
XD-A1250-8Y.	8.75.	11.65.
XD-A1250-15Y.	17.50.	20.40.

● Housing

型号Type.	尺寸(mm).	
	A-	B-
XD-A1250-2x5Y.	5.00.	10.40.
XD-A1250-2x7Y.	7.50.	12.90.
XD-A1250-2x10Y.	11.25.	16.65.
XD-A1250-2x15Y.	17.50.	22.90.
XD-A1250-2x20Y.	23.75.	29.15.

● Wafer

型号Type.	尺寸(mm).	
	A-	B-
XD-A1250-2x5PLT.	5.00.	10.40.
XD-A1250-2x7PLT.	7.50.	12.90.
XD-A1250-2x10PLT.	11.25.	16.65.
XD-A1250-2x15PLT.	17.50.	22.90.
XD-A1250-2x20PLT.	23.75.	29.15.

# 主要技术特征 MAIN SPECIFICATIONS

间距 Pitch: 1.25mm

线数 Poles: 2~15

适用线规 APPLICable Wire: AWG#28- #32

适用基板厚度 APPLICable PC board thickness: 0.6~1.2mm

温度范围 Temperatuer Range: -25°C~ +85°C

额定电压 Voltage Rating: 50V AC, DC

额定电流 Current Rating: 1A AC, DC

接触电阻 Contract Resistance: 20mΩ Max

绝缘电阻 Insulation Resistance: 100mΩ Min

耐压 Withstanding Voltang: 500V

# 材料 MATERIAL

端子 Terminal: Phosphor bronz

孔座 Housing: PA66 UL94V-0

针座 Wafer: Nylon/LCP UL94V-0

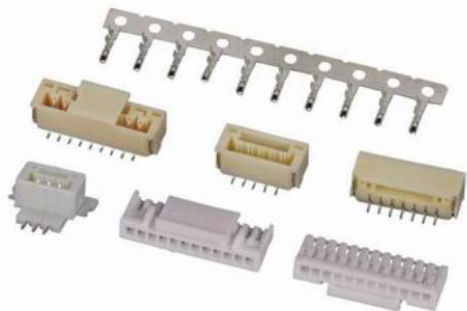

# XD-GH 系列

● Terminal

XD-GH-T

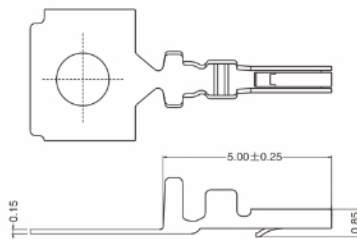

● Housing

XD-GH-NY

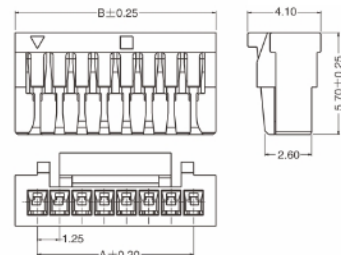

● Wafer

XD-GH-NPWT

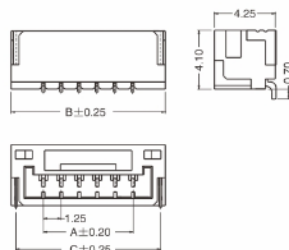

● Wafer

XD-GH-NPLT

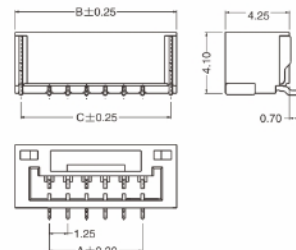

● Housing

型号 Type	尺寸 (mm)	
	A	B
XD-GH-2Y	1.25	3.75
XD-GH-3Y	2.50	5.00
XD-GH-4Y	3.75	6.25
XD-GH-5Y	5.00	7.50
XD-GH-6Y	6.25	8.75
XD-GH-7Y	7.50	10.00
XD-GH-8Y	8.75	11.25
XD-GH-15Y	17.50	20.00

● Wafer

型号 Type	尺寸 (mm)		
	A	B	C
XD-GH-2PWT/LT	1.25	5.75	5.00
XD-GH-3PWT/LT	2.50	7.00	6.25
XD-GH-4PWT/LT	3.75	8.25	7.50
XD-GH-5PWT/LT	5.00	9.50	8.75
XD-GH-6PWT/LT	6.25	10.75	10.00
XD-GH-7PWT/LT	7.50	12.00	11.25
XD-GH-8PWT/LT	8.75	13.25	12.50
XD-GH-15PWT/LT	17.50	22.00	21.25

# 主要技术特征 MAIN SPECIFICATIONS

间距 Pitch: 1.25mm

线数 Poles: 2~15

适用线规 APPLICable Wire: AWG#26- #30

适用基板厚度 APPLICable PC board thickness: 0.6~1.2mm

温度范围 Temperatuer Range: -25°C~ +85°C

额定电压 Voltage Rating: 50V AC, DC

额定电流 Current Rating: 1.25A AC, DC

接触电阻 Contract Resistance: 50mΩ Max

绝缘电阻 Insulation Resistance: 100mΩ Min

耐压 Withstanding Voltang: 500V

# XD-GHD 系列

- Terminal XD-GHD-T

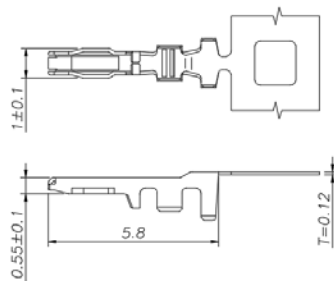

- Housing XD-GHD-2xNY

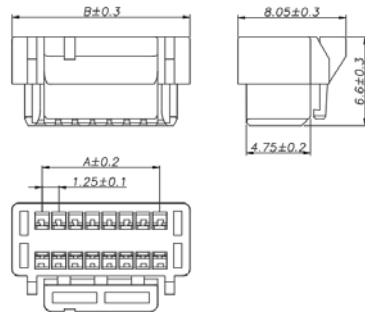

- Wafer XD-GHD-2xNPLT(立贴)

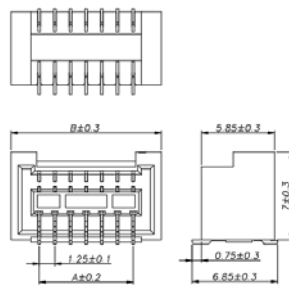

- Wafer XD-GHD-2xNPWT(卧贴)

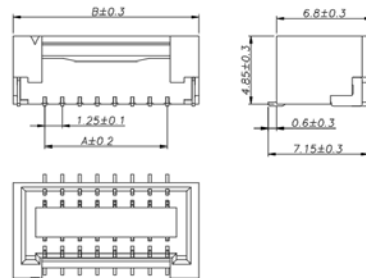

- Housing

型号Type.	尺寸(mm).	
	A.	B.
XD-GHD-2x2Y-X-05.	1.25.	5.75.
XD-GHD-2x3Y-X-05.	2.50.	7.00.
XD-GHD-2x4Y-X-05.	3.75.	8.25.
XD-GHD-2x5Y-X-05.	5.00.	9.50.
XD-GHD-2x20Y-X-05.	23.75.	28.25.

- Wafer

型号Type.	尺寸(mm).	
	A.	B.
XD-GHD-2x2PLT/PWT-X-05.	1.25.	5.75.
XD-GHD-2x3PLT/PWT-X-05.	2.50.	7.00.
XD-GHD-2x4PLT/PWT-X-05.	3.75.	8.25.
XD-GHD-2x5PLT/PWT-X-05.	5.00.	9.50.
XD-GHD-2x6PLT/PWT-X-05.	23.75.	28.25.

# 材料 MATERIAL

端子 Terminal: Phosphor bronz

孔座 Housing: Nylon66 UL94V-0

针座 Wafer: LCP UL94V-0

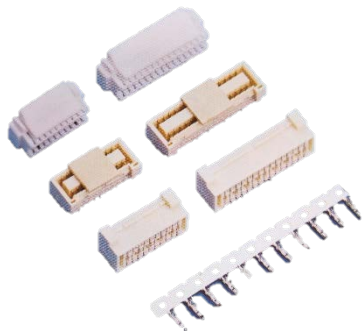

## 主要技术特征 MAIN SPECIFICATIONS

间距 Pitch: 1.25mm

线数 Poles: 2~15

适用线规 APPLICABLE WIRE: AWG#28- #32

温度范围 Temperature Range: -25°C~ +85°C

额定电压 Voltage Rating: 125V AC, DC

额定电流 Current Rating: 1A AC, DC

接触电阻 Contact Resistance: 20mΩ Max

绝缘电阻 Insulation Resistance: 100mΩ Min

耐压 Withstanding Voltage: 500V

## 材料 MATERIAL

端子 Terminal: Phosphor bronze

孔座 Housing: PA66 UL94V-0

针座 Wafer: Nylon/LCP UL94V-0



## XD-1.25 空中对接系列

### Terminal

XD-1.25-PT

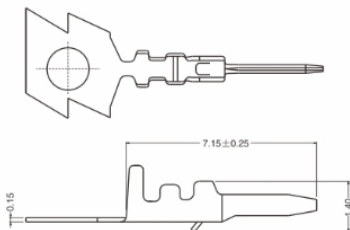

### Housing

XD-1.25-EY

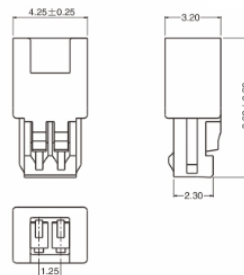

### Housing

XD-1.25-SY

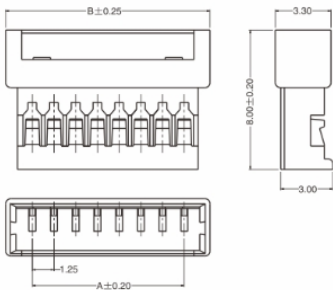

### Housing

型号Type	尺寸(mm)	
	A <sub>e</sub>	B <sub>e</sub>
XD-1.25-2SY/EY <sub>e</sub>	1.25 <sub>e</sub>	4.25 <sub>e</sub>
XD-1.25-3SY/EY <sub>e</sub>	2.50 <sub>e</sub>	5.50 <sub>e</sub>
XD-1.25-4SY/EY <sub>e</sub>	3.75 <sub>e</sub>	6.75 <sub>e</sub>
XD-1.25-5SY/EY <sub>e</sub>	5.00 <sub>e</sub>	8.00 <sub>e</sub>
XD-1.25-6SY/EY <sub>e</sub>	6.25 <sub>e</sub>	9.25 <sub>e</sub>
XD-1.25-7SY/EY <sub>e</sub>	7.50 <sub>e</sub>	10.50 <sub>e</sub>
XD-1.25-8SY/EY <sub>e</sub>	7.50 <sub>e</sub>	11.75 <sub>e</sub>
XD-1.25-9SY/EY <sub>e</sub>	8.75 <sub>e</sub>	13.00 <sub>e</sub>
XD-1.25-10SY/EY <sub>e</sub>	10.00 <sub>e</sub>	14.25 <sub>e</sub>
XD-1.25-11SY/EY <sub>e</sub>	11.25 <sub>e</sub>	15.50 <sub>e</sub>
XD-1.25-12SY/EY <sub>e</sub>	12.50 <sub>e</sub>	16.75 <sub>e</sub>
XD-1.25-15SY/EY <sub>e</sub>	17.50 <sub>e</sub>	20.50 <sub>e</sub>



# 1.5mm 系列

4

• 间距 PITCH: 1.5mm (21~25页)

1.5单排条形连接器 XD-ZH 系列

1.5单排条形连接器 XD-ZE 系列

1.5单排条形连接器 XD-ZA 系列

## 主要技术特征 MAIN SPECIFICATIONS

间距 Pitch: 1.5mm

线数 Poles: 2~16

适用线规 APPLICable Wire: AWG#26- #32

适用基板厚度 APPLICable PC board thickness: 0.6~1.2mm

温度范围 Temperatuer Range: -25°C~ +85°C

额定电压 Voltage Rating: 100V AC, DC

额定电流 Current Rating: 1A AC, DC

接触电阻 Contract Resistance: 20mΩ Max

绝缘电阻 Insulation Resistance: 500mΩ Min

耐压 Withstanding Voltang: 500V AC/1分钟 minute

## 材料 MATERIAL

端子 Terminal: Phosphor bronz

孔座 Housing: Nylon66 UL94V-0

针座 Wafer: Nylon46 UL94V-0

针座(立/卧贴) Wafer: Nylon6T UL94V-0



## XD-ZH 系列 (1)

● Terminal

XD-ZH-T

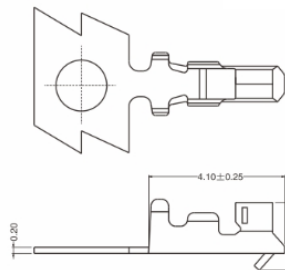

● Housing

XD-ZH-NY

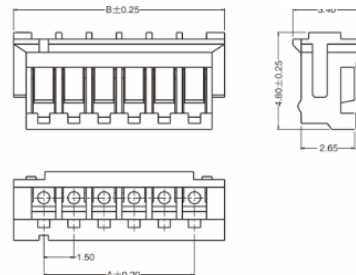

● Housing

XD-ZH1.5-NA

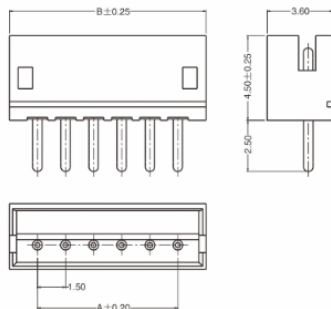

● Wafer

XD-ZH1.5-NAWD

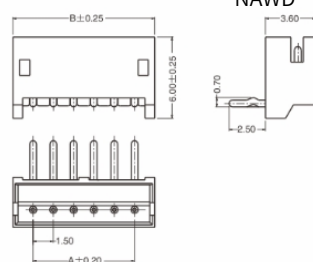

# 主要技术特征 MAIN SPECIFICATIONS

间距 Pitch: 1.5mm  
 线数 Poles: 2~16  
 适用线规 APplicable Wire: AWG#26- #32  
 适用基板厚度 APplicable PC board thickness: 0.6~1.2mm  
 温度范围 Temperatuer Range: -25°C~ +85°C  
 额定电压 Voltage Rating: 100V AC, DC  
 额定电流 Current Rating: 1A AC, DC  
 接触电阻 Contract Resistance: 20mΩ Max  
 绝缘电阻 Insulation Resistance: 500mΩ Min  
 耐压 Withstanding Voltang: 500V AC/1分钟 minute

# XD-ZH 系列 (2)

● Wafer

XD-ZH-NAWT

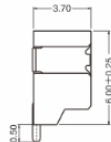
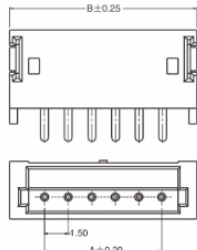

● Wafer

XD-ZH-NPLT

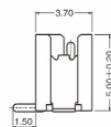
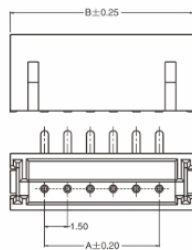

● Housing

● Waf

● Wafer

型号Type	尺寸 (mm)	
	A	B
XD-ZH-2Y	1.50	4.50
XD-ZH-3Y	3.00	6.00
XD-ZH-4Y	4.50	7.50
XD-ZH-5Y	6.00	9.00
XD-ZH-6Y	7.50	10.50
XD-ZH-7Y	9.00	12.00
XD-ZH-8Y	10.50	13.50
XD-ZH-9Y	12.00	15.00
XD-ZH-10Y	13.50	16.50
XD-ZH-11Y	15.00	18.00
XD-ZH-12Y	16.50	19.50
XD-ZH-13Y	18.00	21.00
XD-ZH-14Y	19.50	22.50
XD-ZH-20Y	28.50	31.50

型' ype	尺寸 (mm)	
	A	B
XD-ZH-2A/AW	1.50	4.50
XD-ZH-3A/AW	3.00	6.00
XD-ZH-4A/AW	4.50	7.50
XD-ZH-5A/AW	6.00	9.00
XD-ZH-6A/AW	7.50	10.50
XD-ZH-7A/AW	9.00	12.00
XD-ZH-8A/AW	10.50	13.50
XD-ZH-9A/AW	12.00	15.00
XD-ZH-10A/AW	13.50	16.50
XD-ZH-11A/AW	15.00	18.00
XD-ZH-12A/AW	16.50	19.50
XD-ZH-13A/AW	18.00	21.00
XD-ZH-14A/AW	19.50	22.50
XD-ZH-20A/AW	28.50	31.50

型号Type	尺寸 (mm)	
	A	B
XD-ZH-2AWT/PLT	1.50	6.00
XD-ZH-3AWT/PLT	3.00	7.50
XD-ZH-4AWT/PLT	4.50	9.00
XD-ZH-5AWT/PLT	6.00	10.50
XD-ZH-6AWT/PLT	7.50	12.00
XD-ZH-7AWT/PLT	9.00	13.50
XD-ZH-8AWT/PLT	10.50	15.00
XD-ZH-9AWT/PLT	12.00	16.50
XD-ZH-10AWT/PLT	13.50	18.00
XD-ZH-11AWT/PLT	15.00	19.50
XD-ZH-12AWT/PLT	16.50	21.00
XD-ZH-13AWT/PLT	18.00	22.50
XD-ZH-14AWT/PLT	19.50	24.00
XD-ZH-20AWT/PLT	28.50	33.00

# 材料 MATERIAL

端子 Terminal: Phosphor bronz  
 孔座 Housing: Nylon66 UL94V-0  
 针座 Wafer: Nylon46 UL94V-0  
 针座(立/卧贴) Wafer: Nylon6T UL94V-0



# 主要技术特征 MAIN SPECIFICATIONS

间距 Pitch: 1.5mm

线数 Poles: 2~16

适用线规 APplicable Wire: AWG#28- #32

适用基板厚度 APplicable PC board thickness: 0.6~1.6mm

温度范围 Temperatuer Range: -25°C~ +85°C

额定电压 Voltage Rating: 100V AC, DC

额定电流 Current Rating: 2A AC, DC

接触电阻 Contact Resistance: 20mΩ Max

绝缘电阻 Insulation Resistance: 500mΩ Min

耐压 Withstanding Voltang: 500V

# XD-ZE 系列

## Terminal

XD-ZE-T

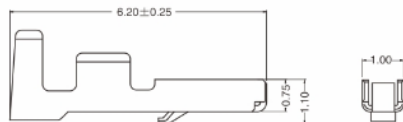

## Housing

XD-ZE-NY

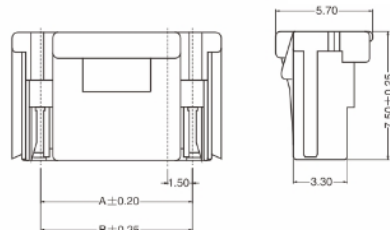

## Wafer

XD-ZE-NPWT

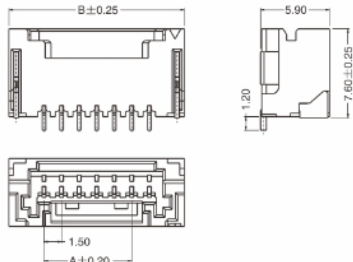

# 材料 MATERIAL

端子 Terminal: Phosphor bronz

孔座 Housing: Nylon66 UL94V-0

针座 Wafer: Nylon46 UL94V-0

针座(立/卧贴) Wafer: Nylon6T UL94V-0

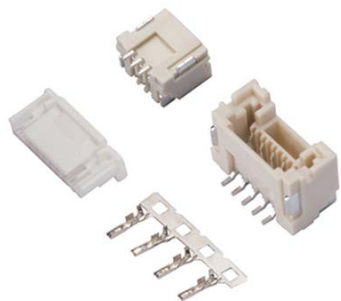

## Housing

型号Type <sup>μ</sup>	尺寸 (mm) <sup>μ</sup>	
	A <sup>μ</sup>	R <sup>μ</sup>
XD-ZE-2Y <sup>μ</sup>	1.50 <sup>μ</sup>	5.00 <sup>μ</sup>
XD-ZE-3Y <sup>μ</sup>	3.00 <sup>μ</sup>	6.50 <sup>μ</sup>
XD-ZE-4Y <sup>μ</sup>	4.50 <sup>μ</sup>	8.00 <sup>μ</sup>
XD-ZE-5Y <sup>μ</sup>	6.00 <sup>μ</sup>	9.50 <sup>μ</sup>
XD-ZE-6Y <sup>μ</sup>	7.50 <sup>μ</sup>	11.00 <sup>μ</sup>
XD-ZE-7Y <sup>μ</sup>	9.00 <sup>μ</sup>	12.50 <sup>μ</sup>
XD-ZE-8Y <sup>μ</sup>	10.50 <sup>μ</sup>	14.00 <sup>μ</sup>
XD-ZE-16Y <sup>μ</sup>	22.50 <sup>μ</sup>	26.00 <sup>μ</sup>

## Wafer

型号Type <sup>μ</sup>	尺寸 (mm) <sup>μ</sup>	
	A <sup>μ</sup>	R <sup>μ</sup>
XD-ZE-2PWT <sup>μ</sup>	1.50 <sup>μ</sup>	7.50 <sup>μ</sup>
XD-ZE-3PWT <sup>μ</sup>	3.00 <sup>μ</sup>	9.00 <sup>μ</sup>
XD-ZE-4PWT <sup>μ</sup>	4.50 <sup>μ</sup>	10.50 <sup>μ</sup>
XD-ZE-5PWT <sup>μ</sup>	6.00 <sup>μ</sup>	12.00 <sup>μ</sup>
XD-ZE-6PWT <sup>μ</sup>	7.50 <sup>μ</sup>	13.50 <sup>μ</sup>
XD-ZE-7PWT <sup>μ</sup>	9.00 <sup>μ</sup>	15.00 <sup>μ</sup>
XD-ZE-8PWT <sup>μ</sup>	10.50 <sup>μ</sup>	16.50 <sup>μ</sup>
XD-ZE-16PWT <sup>μ</sup>	22.50 <sup>μ</sup>	28.50 <sup>μ</sup>

# 主要技术特征 MAIN SPECIFICATIONS

间距 Pitch: 1.5mm

线数 Poles: 2~16

适用线规 APPLICable Wire: AWG#28- #32

适用基板厚度 APPLICable PC board thickness: 0.6~1.6mm

温度范围 Temperatuer Range: -25°C~ +85°C

额定电压 Voltage Rating: 100V AC, DC

额定电流 Current Rating: 2A AC, DC

接触电阻 Contract Resistance: 20mΩ Max

绝缘电阻 Insulation Resistance: 500mΩ Min

耐压 Withstanding Voltang: 500V

# 材料 MATERIAL

端子 Terminal: Phosphor bronz

孔座 Housing: Nylon66 UL94V-0

针座 Wafer: Nylon46 UL94V-0

针座(立/卧贴) Wafer: Nylon6T UL94V-0

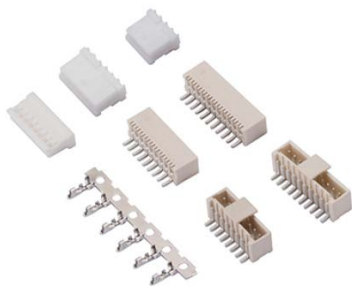

# XD-ZA 系列

## Terminal

XD-ZA-T

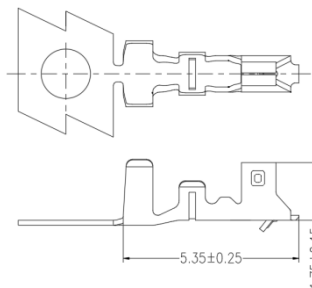

## Housing

XD-ZA-NY

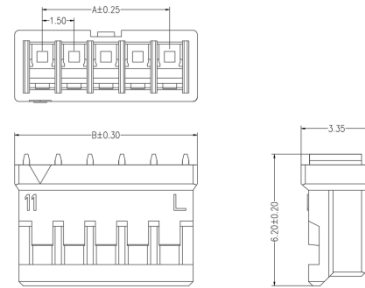

## Wafer

XD-ZA-NPLT

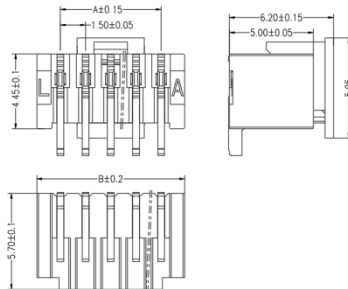

## Wafer

XD-ZA-NPWT

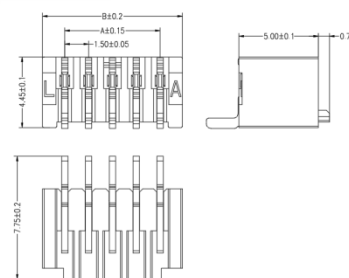

## Housing

型号Type <sub>0</sub>	尺寸(mm) <sub>0</sub>	
	A <sub>0</sub>	B <sub>0</sub>
XD-ZA-2Y-04 <sub>0</sub>	1.50 <sub>0</sub>	4.10 <sub>0</sub>
XD-ZA-3Y-04 <sub>0</sub>	3.00 <sub>0</sub>	5.60 <sub>0</sub>
XD-ZA-4Y-04 <sub>0</sub>	4.50 <sub>0</sub>	7.10 <sub>0</sub>
XD-ZA-5Y-04 <sub>0</sub>	6.00 <sub>0</sub>	8.60 <sub>0</sub>
XD-ZA-6Y-04 <sub>0</sub>	7.50 <sub>0</sub>	10.10 <sub>0</sub>
XD-ZA-7Y-04 <sub>0</sub>	9.00 <sub>0</sub>	11.60 <sub>0</sub>
XD-ZA-8Y-04 <sub>0</sub>	10.50 <sub>0</sub>	13.10 <sub>0</sub>
XD-ZA-15Y-04 <sub>0</sub>	21.00 <sub>0</sub>	23.60 <sub>0</sub>

## Wafer

型号Type <sub>0</sub>	尺寸(mm) <sub>0</sub>	
	A <sub>0</sub>	B <sub>0</sub>
XD-ZA-2PWT/LT-04 <sub>0</sub>	1.50 <sub>0</sub>	4.30 <sub>0</sub>
XD-ZA-3PWT/LT-04 <sub>0</sub>	3.00 <sub>0</sub>	5.80 <sub>0</sub>
XD-ZA-4PWT/LT-04 <sub>0</sub>	4.50 <sub>0</sub>	7.30 <sub>0</sub>
XD-ZA-5PWT/LT-04 <sub>0</sub>	6.00 <sub>0</sub>	8.80 <sub>0</sub>
XD-ZA-6PWT/LT-04 <sub>0</sub>	7.50 <sub>0</sub>	10.30 <sub>0</sub>
XD-ZA-7PWT/LT-04 <sub>0</sub>	9.00 <sub>0</sub>	11.80 <sub>0</sub>
XD-ZA-8PWT/LT-04 <sub>0</sub>	10.50 <sub>0</sub>	13.30 <sub>0</sub>
XD-ZA-15PWT/LT-04 <sub>0</sub>	21.00 <sub>0</sub>	23.80 <sub>0</sub>

## 2.0mm 系列

5

### • 间距 PITCH: 2.0mm (26~39页)

2.0单排条形连接器 XD-PH 系列

2.0双排条形连接器 XD-PHD 系列

2.0双排条形连接器 XD-PHB 系列

2.0单排条形连接器 XD-PA 系列

2.0单排条形连接器 XD-PAE 系列

2.0单排条形连接器 XD-HY 系列

2.0单排带扣(加高)条形连接器 XD-HYH 系列

2.0双排条形连接器 XD-SPH 系列

2.0空中对接条形连接器 XD-PH 系列

2.0空中对接条形连接器 XD-HY 系列

2.0杜邦连接器 XD-2008 系列

2.0杜邦连接器 XD-2008 系列

# 主要技术特征 MAIN SPECIFICATIONS

间距 Pitch: 2.0mm

线数 Poles: 2~16

适用线规 APPLICable Wire: AWG#24- #30

适用基板厚度 APPLICable PC board thickness: 0.8~1.6mm

温度范围 Temperatuer Range: -25°C~ +85°C

额定电压 Voltage Rating: 250V AC, DC

额定电流 Current Rating: 2A AC, DC

接触电阻 Contract Resistance: 20mΩ Max

绝缘电阻 Insulation Resistance: 1000mΩ Min

耐压 Withstanding Voltang: 800V AC/1分钟minute

# 材料 MATERIAL

端子 Terminal: Phosphor bronz

孔座 Housing: Nylon66 UL94V-0

针座 Wafer: Nylon66 UL94V-0

针座(立/卧贴) Wafer: Nylon6T UL94V-0



# XD-PH 系列 (1)

## Terminal XD-PH-T

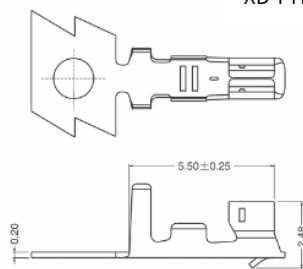

## Housing XD-PH-NY

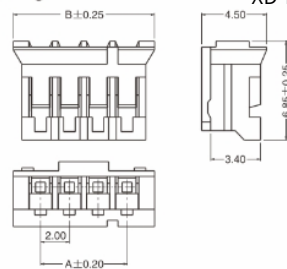

## Wafer XD-PH-PY

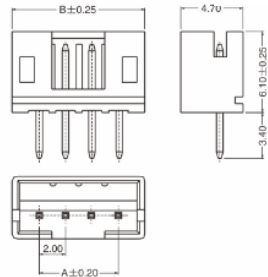

## Terminal XD-PH-NA

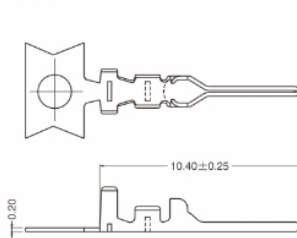

## Housing XD-PH-EY

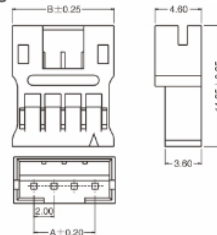

# 主要技术特征 MAIN SPECIFICATIONS

间距 Pitch: 2.0mm

线数 Poles: 2~16

适用线规 APPLICable Wire: AWG#24- #30

适用基板厚度 APPLICable PC board thickness: 0.8~1.6mm

温度范围 Temperatuer Range: -25°C~ +85°C

额定电压 Voltage Rating: 250V AC, DC

额定电流 Current Rating: 2A AC, DC

接触电阻 Contract Resistance: 20mΩ Max

绝缘电阻 Insulation Resistance: 1000mΩ Min

耐压 Withstanding Voltang: 800V AC/1分钟minute

# 材料 MATERIAL

端子 Terminal: Phosphor bronz

孔座 Housing: Nylon66 UL94V-0

针座 Wafer: Nylon66 UL94V-0

针座(立/卧贴) Wafer: Nylon6T UL94V-0

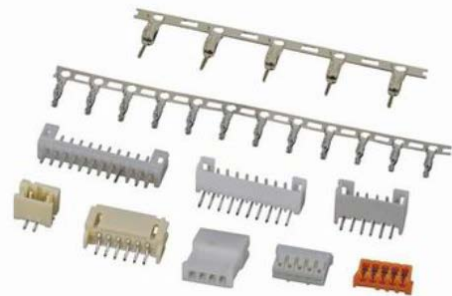

# XD-PH 系列 (2)

● Wafer

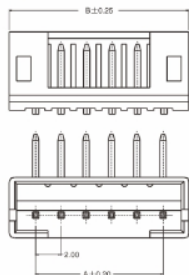

XD-PH-NAW

● Wafer

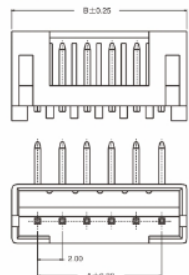

XD-PH-NAWD

● Wafer

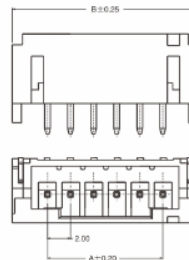

XD-PH-NAT

● Wafer

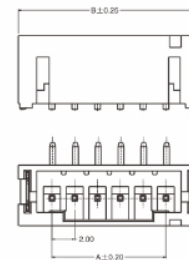

XD-PH-NALT

● Housing

型号 Type	尺寸 (mm)	
	A	B
XD-PH-2Y/PY/EY	2.00	6.00
XD-PH-3Y/PY/EY	4.00	8.00
XD-PH-4Y/PY/EY	6.00	10.00
XD-PH-5Y/PY/EY	8.00	12.00
XD-PH-6Y/PY/EY	10.00	14.00
XD-PH-7Y/PY/EY	12.00	16.00
XD-PH-8Y/PY/EY	14.00	18.00
XD-PH-16Y/PY/EY	30.00	34.00

● Wafer

型号 Type	尺寸 (mm)	
	A	B
XD-PH-2A/AW/AWD	2.00	6.00
XD-PH-3A/AW/AWD	4.00	8.00
XD-PH-4A/AW/AWD	6.00	10.00
XD-PH-5A/AW/AWD	8.00	12.00
XD-PH-6A/AW/AWD	10.00	14.00
XD-PH-7A/AW/AWD	12.00	16.00
XD-PH-8A/AW/AWD	14.00	18.00
XD-PH-16A/AW/AWD	30.00	34.00

● Wafer

型号 Type	尺寸 (mm)	
	A	B
XD-PH-2AW/LT	2.00	8.00
XD-PH-3AW/LT	4.00	10.00
XD-PH-4AW/LT	6.00	12.00
XD-PH-5AW/LT	8.00	14.00
XD-PH-6AW/LT	10.00	16.00
XD-PH-7AW/LT	12.00	18.00
XD-PH-8AW/LT	14.00	20.00
XD-PH-16AW/LT	30.00	36.00



# 主要技术特征 MAIN SPECIFICATIONS

间距 Pitch: 2.0mm

线数 Poles: 4~40

适用线规 APPLICable Wire: AWG#22- #28

适用基板厚度 APPLICable PC board thickness: 1.6mm

温度范围 Temperatuer Range: -25°C~ +85°C

额定电压 Voltage Rating: 250V AC, DC

额定电流 Current Rating: 3A AC, DC

接触电阻 Contract Resistance: 20mΩ Max

绝缘电阻 Insulation Resistance: 1000mΩ Min

耐压 Withstanding Voltang: 800V

# XD-PHD 系列

● Terminal

XD-PHD-T

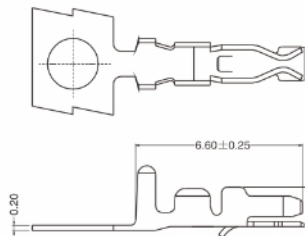

● Housing

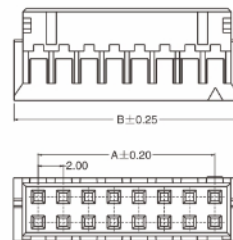

┆ XD-PHD-



● Housing

XD-PHD-2\*NA

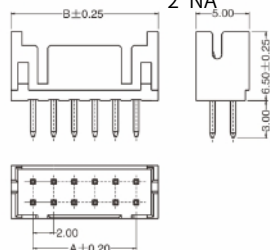

● Wafer

XD-PHD-2\*NAW

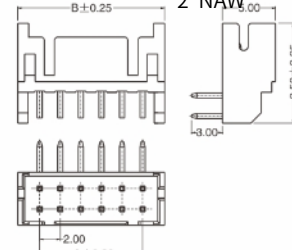

● Wafer

XD-PHDS-2\*NY

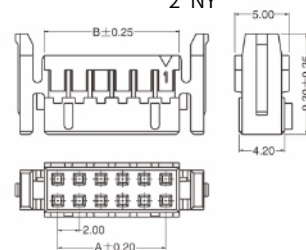

# 材料 MATERIAL

端子 Terminal: Phosphor bronz

孔座 Housing: Nylon66 UL94V-0

针座 Wafer: Nylon66 UL94V-0



● Housing

型号Type	尺寸(mm)	
	A	B
XD-PHD-2*2Y	2.00	6.00
XD-PHD-2*3Y	4.00	8.00
XD-PHD-2*4Y	6.00	10.00
XD-PHD-2*5Y	8.00	12.00
XD-PHD-2*6Y	10.00	14.00
XD-PHD-2*7Y	12.00	16.00
XD-PHD-2*8Y	14.00	18.00
XD-PHD-2*20Y	38.00	42.00

● Wafer

型号Type	尺寸(mm)	
	A	B
XD-PHD-2*2A/AW	2.00	6.00
XD-PHD-2*3A/AW	4.00	8.00
XD-PHD-2*4A/AW	6.00	10.00
XD-PHD-2*5A/AW	8.00	12.00
XD-PHD-2*6A/AW	10.00	14.00
XD-PHD-2*7A/AW	12.00	16.00
XD-PHD-2*8A/AW	14.00	18.00
XD-PHD-2*20A/AW	38.00	42.00

# 主要技术特征 MAIN SPECIFICATIONS

间距 Pitch: 2.0mm

线数 Poles: 10~40

适用线规 APPLICable Wire: AWG#22- #28

适用基板厚度 APPLICable PC board thickness: 1.6mm

温度范围 Temperatuer Range: -25°C~ +85°C

额定电压 Voltage Rating: 250V AC, DC

额定电流 Current Rating: 3A AC, DC

接触电阻 Contract Resistance: 20mΩ Max

绝缘电阻 Insulation Resistance: 1000mΩ Min

耐压 Withstanding Voltang: 800V

# XD-PHB 系列

● Terminal XD-PHB-T

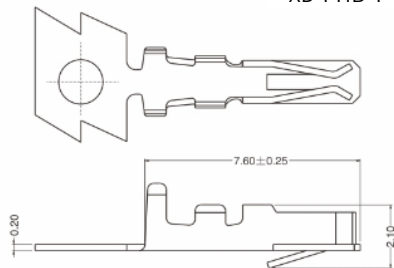

● Housing

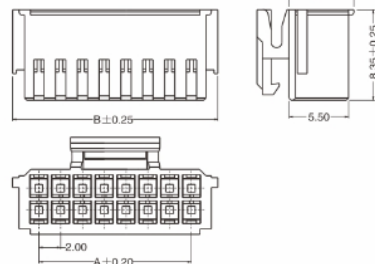

● Wafer

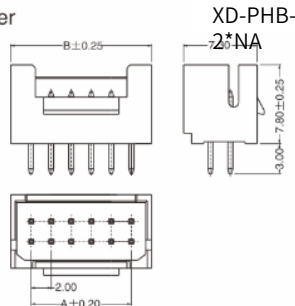

● Wafer

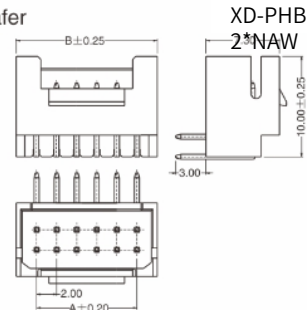

● Housing

型号Type <sup>o</sup>	尺寸(mm) <sup>o</sup>	
	A <sup>o</sup>	B <sup>o</sup>
XD-PHB-2*5Y <sup>o</sup>	8.00 <sup>o</sup>	13.00 <sup>o</sup>
XD-PHB-2*6Y <sup>o</sup>	10.00 <sup>o</sup>	15.00 <sup>o</sup>
XD-PHB-2*7Y <sup>o</sup>	12.00 <sup>o</sup>	17.00 <sup>o</sup>
XD-PHB-2*8Y <sup>o</sup>	14.00 <sup>o</sup>	19.00 <sup>o</sup>
XD-PHB-2*9Y <sup>o</sup>	16.00 <sup>o</sup>	21.00 <sup>o</sup>
XD-PHB-2*10Y <sup>o</sup>	18.00 <sup>o</sup>	23.00 <sup>o</sup>
XD-PHB-2*11Y <sup>o</sup>	20.00 <sup>o</sup>	25.00 <sup>o</sup>
XD-PHB-2*20Y <sup>o</sup>	38.00 <sup>o</sup>	43.00 <sup>o</sup>

● Wafer

型号Type <sup>o</sup>	尺寸(mm) <sup>o</sup>	
	A <sup>o</sup>	B <sup>o</sup>
XD-PHB-2*5A/AW <sup>o</sup>	8.00 <sup>o</sup>	12.00 <sup>o</sup>
XD-PHB-2*6A/AW <sup>o</sup>	10.00 <sup>o</sup>	14.00 <sup>o</sup>
XD-PHB-2*7A/AW <sup>o</sup>	12.00 <sup>o</sup>	16.00 <sup>o</sup>
XD-PHB-2*8A/AW <sup>o</sup>	14.00 <sup>o</sup>	18.00 <sup>o</sup>
XD-PHB-2*9A/AW <sup>o</sup>	16.00 <sup>o</sup>	20.00 <sup>o</sup>
XD-PHB-2*10A/AW <sup>o</sup>	18.00 <sup>o</sup>	22.00 <sup>o</sup>
XD-PHB-2*11A/AW <sup>o</sup>	20.00 <sup>o</sup>	24.00 <sup>o</sup>
XD-PHB-2*20A/AW <sup>o</sup>	38.00 <sup>o</sup>	42.00 <sup>o</sup>

# 材料 MATERIAL

端子 Terminal: Phosphor bronz

孔座 Housing: Nylon66 UL94V-0

针座 Wafer: Nylon66 UL94V-0



# 主要技术特征 MAIN SPECIFICATIONS

间距 Pitch: 2.0mm

线数 Poles: 2~16

适用线规 APplicable Wire: AWG#22- #28

适用基板厚度 APplicable PC board thickness: 1.6mm

温度范围 Temperatuer Range: -25°C~ +85°C

额定电压 Voltage Rating: 100V AC, DC

额定电流 Current Rating: 3A AC, DC

接触电阻 Contract Resistance: 20mΩ Max

绝缘电阻 Insulation Resistance: 1000mΩ Min

耐压 Withstanding Voltang: 800V

# 材料 MATERIAL

端子 Terminal: Phosphor bronz

孔座 Housing: Nylon66 UL94V-0

针座 Wafer: PBT UL94V-0



# XD-PA 系列

## Terminal XD-PA-T

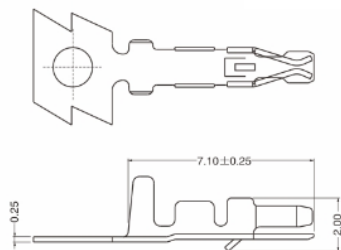

## Housing XD-PA-Y

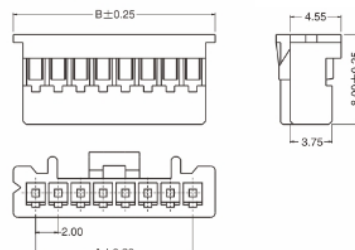

## Wafer XD-PA-NA

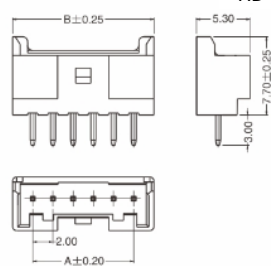

## Wafer XD-PA-NAWD

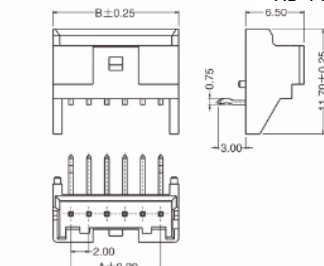

## Housing

型号 Type	尺寸 (mm)	
	A	B
XD-PA-2Y	2.00	6.00
XD-PA-3Y	4.00	8.00
XD-PA-4Y	6.00	10.00
XD-PA-5Y	8.00	12.00
XD-PA-6Y	10.00	14.00
XD-PA-7Y	12.00	16.00
XD-PA-8Y	14.00	18.00
XD-PA-16Y	30.00	34.00

## Wafer

型号 Type	尺寸 (mm)	
	A	B
XD-PA-2A/AWD	2.00	6.00
XD-PA-3A/AWD	4.00	8.00
XD-PA-4A/AWD	6.00	10.00
XD-PA-5A/AWD	8.00	12.00
XD-PA-6A/AWD	10.00	14.00
XD-PA-7A/AWD	12.00	16.00
XD-PA-8A/AWD	14.00	18.00
XD-PA-16A/AWD	30.00	34.00

# 主要技术特征 MAIN SPECIFICATIONS

间距 Pitch: 2.0mm

线数 Poles: 2~12

适用线规 APplicable Wire: AWG#22- #28

适用基板厚度 APplicable PC board thickness: 1.6mm

温度范围 Temperatuer Range: -25°C~ +85°C

额定电压 Voltage Rating: 300V AC, DC

额定电流 Current Rating: 3A AC, DC

接触电阻 Contract Resistance: 20mΩ Max

绝缘电阻 Insulation Resistance: 1000mΩ Min

耐压 Withstanding Voltang: 800V

# 材料 MATERIAL

端子 Terminal: Phosphor bronz

孔座 Housing: Nylon66 UL94V-0

针座 Wafer: Nylon6T UL94V-0

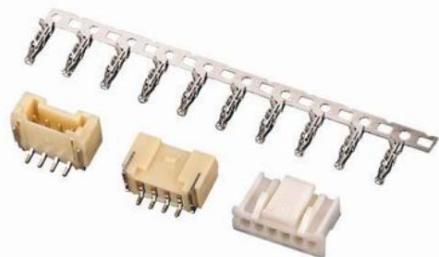

# XD-PAE 系列

## ● Terminal XD-PA-T

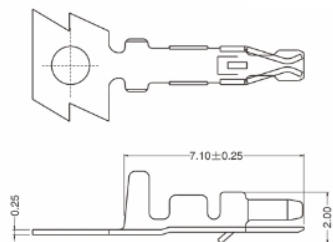

## ● Housing XD-PA-Y

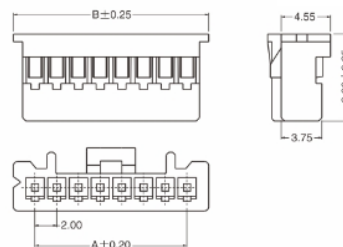

## ● Wafer XD-PAE-NAWT

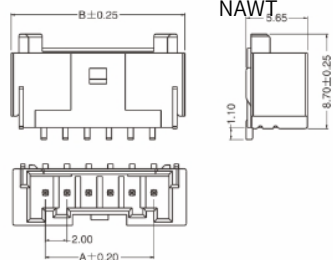

## ● Wafer XD-PAE-NALT

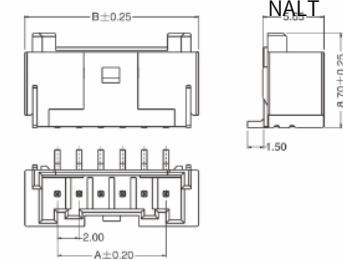

## ● Housing

型号Type <sub>v</sub>	尺寸(mm) <sub>v</sub>	
	A <sub>v</sub>	B <sub>v</sub>
XD-PAE-2Y <sub>v</sub>	2.00 <sub>v</sub>	6.00 <sub>v</sub>
XD-PAE-3Y <sub>v</sub>	4.00 <sub>v</sub>	8.00 <sub>v</sub>
XD-PAE-4Y <sub>v</sub>	6.00 <sub>v</sub>	10.00 <sub>v</sub>
XD-PAE-5Y <sub>v</sub>	8.00 <sub>v</sub>	12.00 <sub>v</sub>
XD-PAE-6Y <sub>v</sub>	10.00 <sub>v</sub>	14.00 <sub>v</sub>
XD-PAE-7Y <sub>v</sub>	12.00 <sub>v</sub>	16.00 <sub>v</sub>
XD-PAE-8Y <sub>v</sub>	14.00 <sub>v</sub>	18.00 <sub>v</sub>
XD-PAE-12Y <sub>v</sub>	22.00 <sub>v</sub>	26.00 <sub>v</sub>

## ● Wafer

型号Type <sub>v</sub>	尺寸(mm) <sub>v</sub>	
	A <sub>v</sub>	B <sub>v</sub>
XD-PAE-2AWT/LT <sub>v</sub>	2.00 <sub>v</sub>	8.00 <sub>v</sub>
XD-PAE-3AWT/LT <sub>v</sub>	4.00 <sub>v</sub>	10.00 <sub>v</sub>
XD-PAE-4AWT/LT <sub>v</sub>	6.00 <sub>v</sub>	12.00 <sub>v</sub>
XD-PAE-5AWT/LT <sub>v</sub>	8.00 <sub>v</sub>	14.00 <sub>v</sub>
XD-PAE-6AWT/LT <sub>v</sub>	10.00 <sub>v</sub>	16.00 <sub>v</sub>
XD-PAE-7AWT/LT <sub>v</sub>	12.00 <sub>v</sub>	18.00 <sub>v</sub>
XD-PAE-8AWT/LT <sub>v</sub>	14.00 <sub>v</sub>	20.00 <sub>v</sub>
XD-PAE-12AWT/LT <sub>v</sub>	22.00 <sub>v</sub>	28.00 <sub>v</sub>

# 主要技术特征 MAIN SPECIFICATIONS

间距 Pitch: 2.0mm

线数 Poles: 2~20

适用线规 APPLICable Wire: AWG#24- #30

适用基板厚度 APPLICable PC board thickness: 0.8~1.6mm

温度范围 Temperatuer Range: -25°C~ +85°C

额定电压 Voltage Rating: 250V AC, DC

额定电流 Current Rating: 2A AC, DC

接触电阻 Contract Resistance: 20mΩ Max

绝缘电阻 Insulation Resistance: 1000mΩ Min

耐压 Withstanding Voltang: 1000V

# 材料 MATERIAL

端子 Terminal: Phosphor bronz

孔座 Housing: Nylon66 UL94V-0

针座 Wafer: Nylon66 UL94V-0

针座(立/卧贴) Wafer: LCP UL94V-0

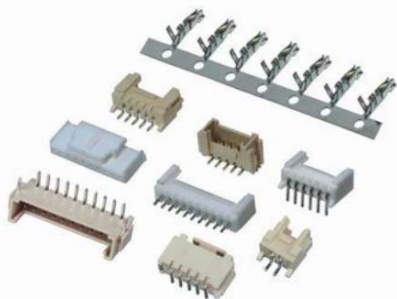

# XD-HY 系列 (1)

## Terminal

XD-HY-T

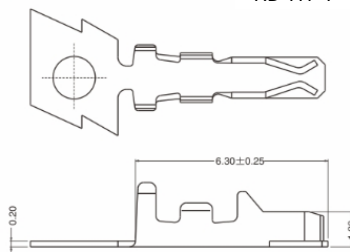

## Housing

XD-HY-NY

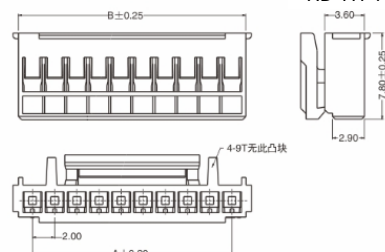

## Wafer

XD-HY-NA

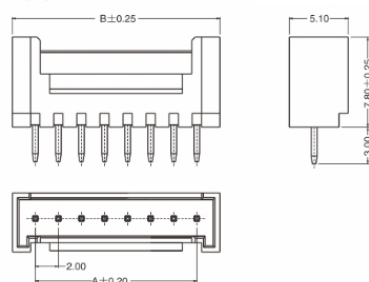

## Wafer

XD-HY-NAW

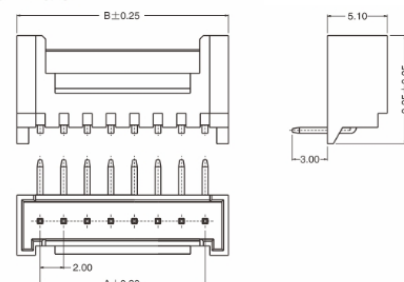

## Wafer

XD-HY-NAWT

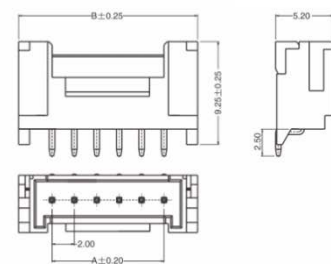

## Housing

XD-HY-NALT

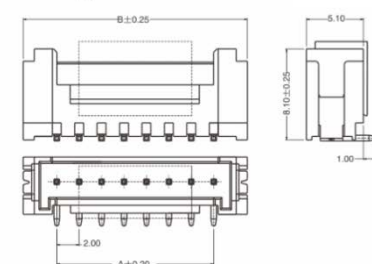

# 主要技术特征 MAIN SPECIFICATIONS

间距 Pitch: 2.0mm

线数 Poles: 2~20

适用线规 APPLICable Wire: AWG#24- #30

适用基板厚度 APPLICable PC board thickness: 0.8~1.6mm

温度范围 Temperatuer Range: -25°C~ +85°C

额定电压 Voltage Rating: 250V AC, DC

额定电流 Current Rating: 2A AC, DC

接触电阻 Contract Resistance: 20mΩ Max

绝缘电阻 Insulation Resistance: 1000mΩ Min

耐压 Withstanding Voltang: 1000V

# XD-HY 系列 (2)

## ● Wafer

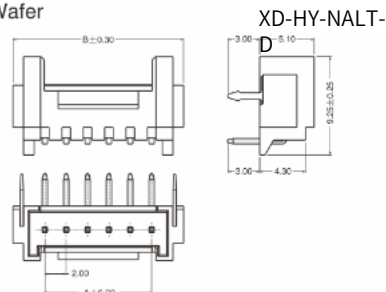

## ● Housing

型号 Type	尺寸 (mm)	
	A	B
XD-HY-2Y	2.00	4.80
XD-HY-3Y	4.00	6.80
XD-HY-4Y	6.00	8.80
XD-HY-5Y	8.00	10.80
XD-HY-6Y	10.00	12.80
XD-HY-7Y	12.00	14.80
XD-HY-20Y	38.00	40.80

## ● Wafer

型号 Type	尺寸 (mm)	
	A	B
XD-HY-2ALT-D	2.00	8.00
XD-HY-3ALT-D	4.00	10.00
XD-HY-4ALT-D	6.00	12.00
XD-HY-5ALT-D	8.00	14.00
XD-HY-6ALT-D	10.00	16.00
XD-HY-7ALT-D	12.00	18.00
XD-HY-20ALT-D	38.00	44.00

## ● Wafer

型号 Type	尺寸 (mm)	
	A	B
XD-HY-2A/AW	2.00	6.00
XD-HY-3A/AW	4.00	8.00
XD-HY-4A/AW	6.00	10.00
XD-HY-5A/AW	8.00	12.00
XD-HY-6A/AW	10.00	14.00
XD-HY-7A/AW	12.00	16.00
XD-HY-20A/AW	38.00	42.00

## ● Wafer

型号 Type	尺寸 (mm)	
	A	B
XD-HY-2AWT/LT	2.00	8.00
XD-HY-3AWT/LT	4.00	10.00
XD-HY-4AWT/LT	6.00	12.00
XD-HY-5AWT/LT	8.00	14.00
XD-HY-6AWT/LT	10.00	16.00
XD-HY-7AWT/LT	12.00	18.00
XD-HY-20AWT/LT	38.00	44.00

# 材料 MATERIAL

端子 Terminal: Phosphor bronz

孔座 Housing: Nylon66 UL94V-0

针座 Wafer: Nylon66 UL94V-0

针座(立/卧贴) Wafer: LCP UL94V-0

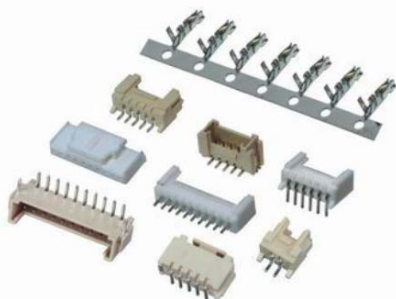

## 主要技术特征 MAIN SPECIFICATIONS

间距 Pitch: 2.0mm

线数 Poles: 2~20

适用线规 APPLICable Wire: AWG#24- #30

适用基板厚度 APPLICable PC board thickness: 0.8~1.6mm

温度范围 Temperatuer Range: -25°C~ +85°C

额定电压 Voltage Rating: 250V AC, DC

额定电流 Current Rating: 2A AC, DC

接触电阻 Contract Resistance: 20mΩ Max

绝缘电阻 Insulation Resistance: 1000mΩ Min

耐压 Withstanding Voltang: 1000V

## 材料 MATERIAL

针座 Wafer: Nylon66 UL94V-0

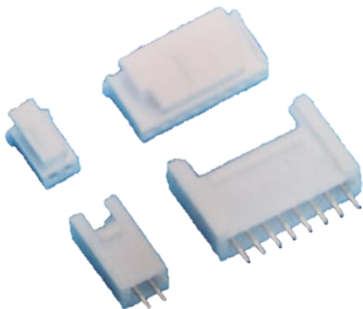

## XD-HYH 系列

### ● Wafer XD-HYH-NA-X

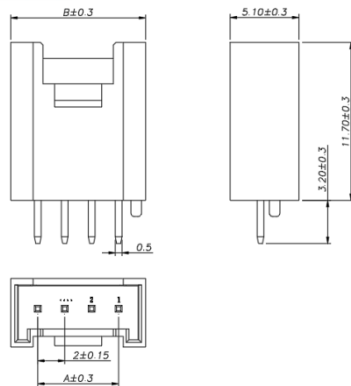

### ● Wafer

型号 Type	尺寸 (mm)	
	A	B
XD-HYH-2A-X	2.00	6.00
XD-HYH-3A-X	4.00	8.00
XD-HYH-4A-X	6.00	10.00
XD-HYH-5A-X	8.00	12.00
XD-HYH-6A-X	10.00	14.00
XD-HYH-7A-X	12.00	16.00
XD-HYH-8A-X	14.00	18.00
XD-HYH-20A-X	38.00	42.00



# 主要技术特征 MAIN SPECIFICATIONS

间距 Pitch: 2.0mm

线数 Poles: 4~40

适用线规 APPLICable Wire: AWG#28- #30

适用基板厚度 APPLICable PC board thickness: 1.6mm

温度范围 Temperatuer Range: -25°C~ +85°C

额定电压 Voltage Rating: 250V AC, DC

额定电流 Current Rating: 3A AC, DC

接触电阻 Contract Resistance: 20mΩ Max

绝缘电阻 Insulation Resistance: 1000mΩ Min

耐压 Withstanding Voltang: 800V

# XD-SPH 系列

## Terminal

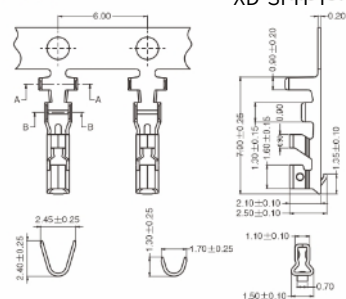

## Housing

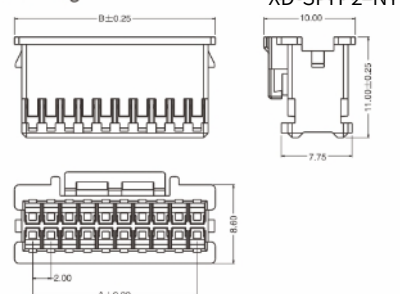

## Wafer

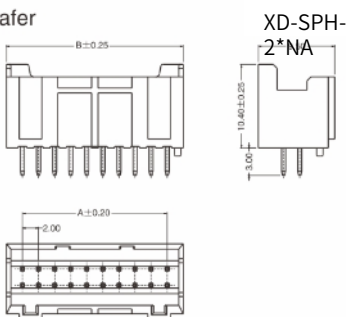

## Wafer

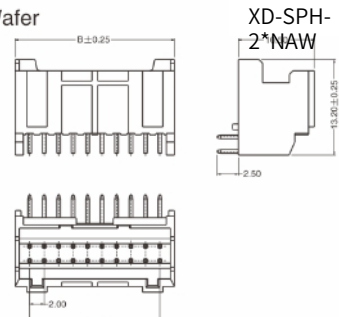

# 材料 MATERIAL

端子 Terminal: Phosphor bronz

孔座 Housing: Nylon66 UL94V-0

针座 Wafer: Nylon66 UL94V-0

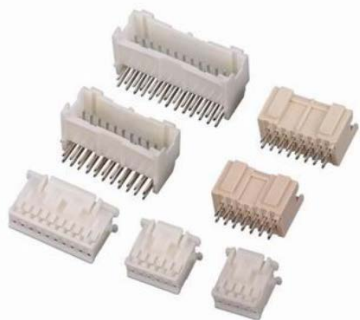

## Housing

型号Type	尺寸(mm)	
	A	B
XD-SPH-2*2Y	2.00	6.00
XD-SPH-2*3Y	4.00	8.00
XD-SPH-2*4Y	6.00	10.00
XD-SPH-2*5Y	8.00	12.00
XD-SPH-2*6Y	10.00	14.00
XD-SPH-2*7Y	12.00	16.00
XD-PHB-2*20Y	38.00	42.00

## Wafer

型号Type	尺寸(mm)	
	A	B
XD-SPH-2*2A/AW	2.00	6.00
XD-SPH-2*3A/AW	4.00	8.00
XD-SPH-2*4A/AW	6.00	10.00
XD-SPH-2*5A/AW	8.00	12.00
XD-SPH-2*6A/AW	10.00	14.00
XD-SPH-2*7A/AW	12.00	16.00
XD-PHB-2*20A/AW	32.00	42.00



# 主要技术特征 MAIN SPECIFICATIONS

间距 Pitch: 2.0mm

线数 Poles: 2~15

适用线规 APPLICABLE WIRE: AWG#24- #28

温度范围 Temperatuer Range: -25°C~ +85°C

额定电压 Voltage Rating: 125V AC, DC

额定电流 Current Rating: 2A AC, DC

接触电阻 Contact Resistance: 20mΩ Max

绝缘电阻 Insulation Resistance: 1000mΩ Min

耐压 Withstanding Voltang: 500V

# 材料 MATERIAL

端子 Terminal: Phosphor bronz

孔座 Housing: PBT UL94V-0



# XD-PH 空中对接 系列

● Terminal XD-PH-ST

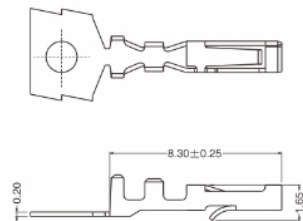

● Terminal XD-PH-PT

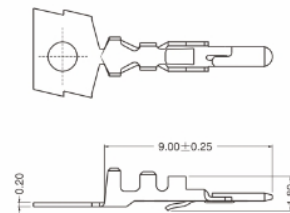

● Housing XD-PH-NSY

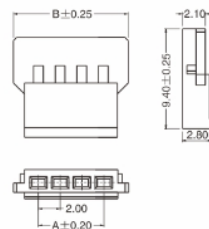

● Housing XD-PH-EY

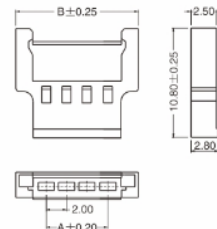

● Housing

型号 Type <sup>o</sup>	尺寸 (mm) <sup>o</sup>	
	A <sup>o</sup>	B <sup>o</sup>
XD-PH-2SY <sup>o</sup>	2.00 <sup>o</sup>	8.00 <sup>o</sup>
XD-PH-3SY <sup>o</sup>	4.00 <sup>o</sup>	10.00 <sup>o</sup>
XD-PH-4SY <sup>o</sup>	6.00 <sup>o</sup>	12.00 <sup>o</sup>
XD-PH-5SY <sup>o</sup>	8.00 <sup>o</sup>	14.00 <sup>o</sup>
XD-PH-6SY <sup>o</sup>	10.00 <sup>o</sup>	16.00 <sup>o</sup>
XD-PH-7SY <sup>o</sup>	12.00 <sup>o</sup>	18.00 <sup>o</sup>
XD-PH-8SY <sup>o</sup>	14.00 <sup>o</sup>	20.00 <sup>o</sup>
XD-PH-15SY <sup>o</sup>	28.00 <sup>o</sup>	34.00 <sup>o</sup>

● Housing

型号 Type <sup>o</sup>	尺寸 (mm) <sup>o</sup>	
	A <sup>o</sup>	B <sup>o</sup>
XD-PH-2EY <sup>o</sup>	2.00 <sup>o</sup>	8.00 <sup>o</sup>
XD-PH-3EY <sup>o</sup>	4.00 <sup>o</sup>	10.00 <sup>o</sup>
XD-PH-4EY <sup>o</sup>	6.00 <sup>o</sup>	12.00 <sup>o</sup>
XD-PH-5EY <sup>o</sup>	8.00 <sup>o</sup>	14.00 <sup>o</sup>
XD-PH-6EY <sup>o</sup>	10.00 <sup>o</sup>	16.00 <sup>o</sup>
XD-PH-7EY <sup>o</sup>	12.00 <sup>o</sup>	18.00 <sup>o</sup>
XD-PH-8EY <sup>o</sup>	14.00 <sup>o</sup>	20.00 <sup>o</sup>
XD-PH-15EY <sup>o</sup>	28.00 <sup>o</sup>	34.00 <sup>o</sup>

## 主要技术特征 MAIN SPECIFICATIONS

间距 Pitch: 2.0mm

线数 Poles: 2~15

适用线规 APPLICABLE WIRE: AWG#22- #30

温度范围 Temperatuer Range: -25°C~ +85°C

额定电压 Voltage Rating: 250V AC, DC

额定电流 Current Rating: 2A AC, DC

接触电阻 Contract Resistance: 20mΩ Max

绝缘电阻 Insulation Resistance: 1000mΩ Min

耐压 Withstanding Voltang: 1000V

## 材料 MATERIAL

端子 Terminal: Phosphor bronz

孔座 Housing: Nylon66 UL94V-0



## XD-HY 空中对接 系列

### ● Terminal XD-HY-PT

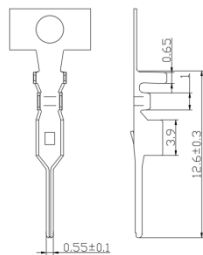

### ● Housing XD-HY-NEY

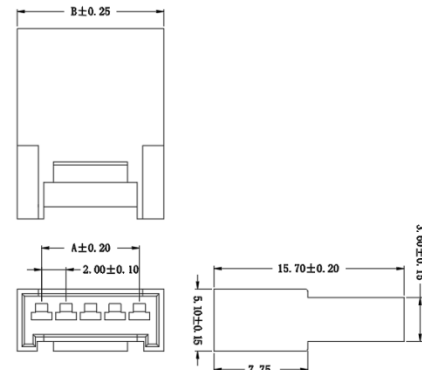

### ● Housing

型号 Type	尺寸 (mm)	
	A	B
XD-HY-2EY	2.00	6.00
XD-HY-3EY	4.00	8.00
XD-HY-4EY	6.00	10.00
XD-HY-5EY	8.00	12.00
XD-HY-6EY	10.00	14.00
XD-HY-7EY	12.00	16.00
XD-HY-8EY	14.00	18.00
XD-PAE-15Y	28.00	32.00

## 主要技术特征 MAIN SPECIFICATIONS

间距 Pitch: 2.0mm

线数 Poles: 2~42

适用线规 APPLICABLE WIRE: AWG#26- #30

温度范围 Temperatuer Range: -25°C~ +85°C

额定电压 Voltage Rating: 250V AC, DC

额定电流 Current Rating: 2A AC, DC

接触电阻 Contract Resistance: 20mΩ Max

绝缘电阻 Insulation Resistance: 1000mΩ Min

耐压 Withstanding Voltang: 500V

## 材料 MATERIAL

端子 Terminal: Phosphor bronz

孔座 Housing: Nylon66 UL94V-0

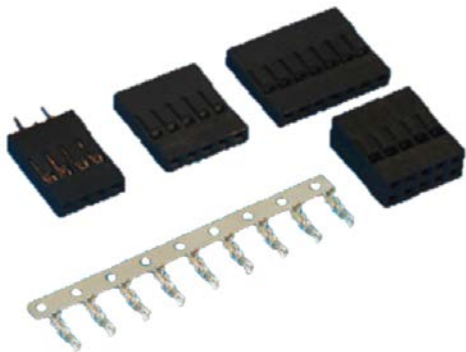

## XD-2008 杜邦 系列

● Terminal

XD-2008-T

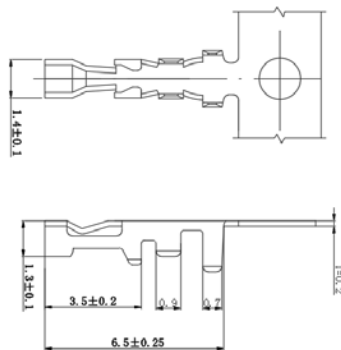

● Housing

XD-2008-2xNY

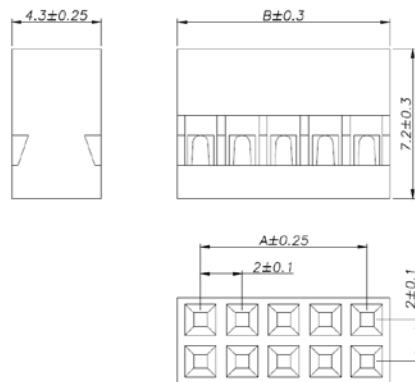

● Housing

型号Type.	尺寸(mm).	
	A.	B.
XD-2008-2x2Y-X.	2.00.	4.20.
XD-2008-2x3Y-X.	4.00.	6.20.
XD-2008-2x4Y-X.	6.00.	8.20.
XD-2008-2x5Y-X.	8.00.	10.20.
XD-2008-2x6Y-X.	10.00.	12.20.
XD-2008-2x7Y-X.	12.00.	14.20.
XD-2008-2x8Y-X.	14.00.	16.20.
XD-2008-2x42Y-X.	82.00.	84.20.

# 2.5mm 系列

6

## • 间距 PITCH: 2.5mm (40~52页)

2.5单排条形连接器 XD-XH (TJC3) 系列

2.5单排条形连接器 XD-XHB 系列

2.5双排条形连接器 XD-XHD 系列

2.5单排(加高)条形连接器 XD-XHL 系列

2.5单排条形连接器 XD-XA 系列

2.5单排条形连接器 XD-HA 系列

2.5单排条形连接器 XD-5264 系列

2.5双排条形连接器 XD-XAD 系列

2.54双排条形连接器 XD-2510 系列

2.54刺破条形连接器 XD-A2510 系列

## 主要技术特征 MAIN SPECIFICATIONS

间距 Pitch: 2.5mm

线数 Poles: 2~20

适用线规 APPLICable Wire: AWG#22- #28

适用基板厚度 APPLICable PC board thickness: 1.6mm

温度范围 Temperatuer Range: -25°C~ +85°C

额定电压 Voltage Rating: 250V AC, DC

额定电流 Current Rating: 3A AC, DC

接触电阻 Contract Resistance: 20mΩ Max

绝缘电阻 Insulation Resistance: 1000mΩ Min

耐压 Withstanding Voltang: 1000V AC/1分钟minute

## 材料 MATERIAL

端子 Terminal: Phosphor bronz

孔座 Housing: Nylon66 UL94V-0

针座 Wafer: Nylon66 UL94V-0

针座(立/卧贴) Wafer: LCP UL94V-0



## XD-XH 系列 (1)

### Terminal

XD-XH-T17.3

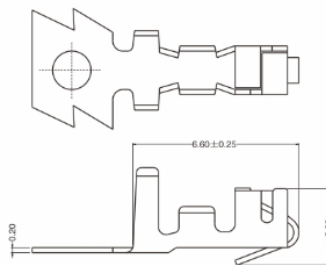

### Housing

XD-XH-Y

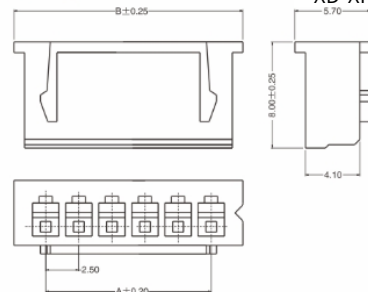

### Wafer

XD-XH-NA

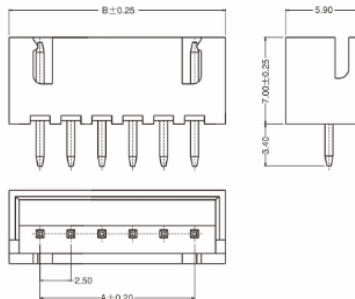

### Wafer

XD-XH-NAW

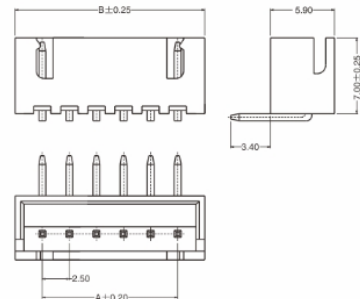

# 主要技术特征 MAIN SPECIFICATIONS

间距 Pitch: 2.5mm

线数 Poles: 2~20

适用线规 APPLICable Wire: AWG#22- #28

适用基板厚度 APPLICable PC board thickness: 1.6mm

温度范围 Temperatuer Range: -25°C~ +85°C

额定电压 Voltage Rating: 250V AC, DC

额定电流 Current Rating: 3A AC, DC

接触电阻 Contract Resistance: 20mΩ Max

绝缘电阻 Insulation Resistance: 1000mΩ Min

耐压 Withstanding Voltang: 1000V AC/1分钟minute

# XD-XH 系列 (2)

● Wafer

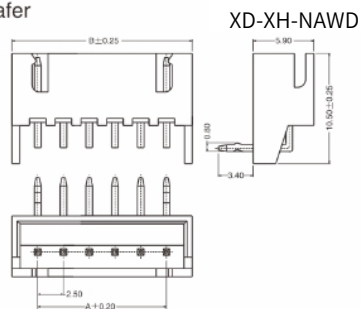

● Wafer

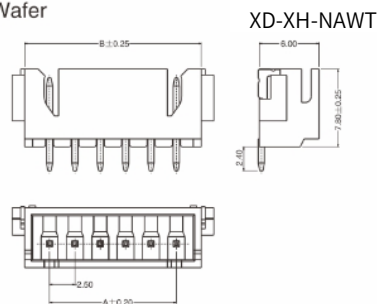

● Wafer

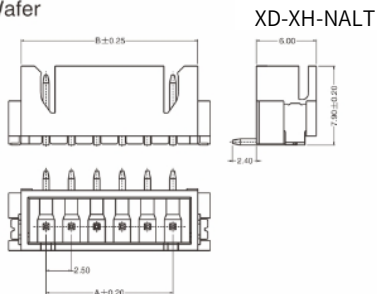

● Housing

型号Type <sub>0</sub>	尺寸(mm) <sub>0</sub>	
	A <sub>0</sub>	R <sub>0</sub>
XD-XH-2Y <sub>0</sub>	2.50 <sub>0</sub>	7.50 <sub>0</sub>
XD-XH-3Y <sub>0</sub>	5.00 <sub>0</sub>	10.00 <sub>0</sub>
XD-XH-4Y <sub>0</sub>	7.50 <sub>0</sub>	12.50 <sub>0</sub>
XD-XH-5Y <sub>0</sub>	10.00 <sub>0</sub>	15.00 <sub>0</sub>
XD-XH-6Y <sub>0</sub>	12.50 <sub>0</sub>	17.50 <sub>0</sub>
XD-XH-7Y <sub>0</sub>	15.00 <sub>0</sub>	20.00 <sub>0</sub>
XD-XH-8Y <sub>0</sub>	17.50 <sub>0</sub>	22.50 <sub>0</sub>
XD-XH-20Y <sub>0</sub>	47.50 <sub>0</sub>	52.50 <sub>0</sub>

● Wafer

型号Type <sub>0</sub>	尺寸(mm) <sub>0</sub>	
	A <sub>0</sub>	R <sub>0</sub>
XD-XH-2A/ AW/ AWD <sub>0</sub>	2.50 <sub>0</sub>	7.50 <sub>0</sub>
XD-XH-3A/ AW/ AWD <sub>0</sub>	5.00 <sub>0</sub>	10.00 <sub>0</sub>
XD-XH-4A/ AW/ AWD <sub>0</sub>	7.50 <sub>0</sub>	12.50 <sub>0</sub>
XD-XH-5A/ AW/ AWD <sub>0</sub>	10.00 <sub>0</sub>	15.00 <sub>0</sub>
XD-XH-6A/ AW/ AWD <sub>0</sub>	12.50 <sub>0</sub>	17.50 <sub>0</sub>
XD-XH-7A/ AW/ AWD <sub>0</sub>	15.00 <sub>0</sub>	20.00 <sub>0</sub>
XD-XH-8A/ AW/ AWD <sub>0</sub>	17.50 <sub>0</sub>	22.50 <sub>0</sub>
XD-XH-20A/ AW/ AWD <sub>0</sub>	47.50 <sub>0</sub>	52.50 <sub>0</sub>

● Wafer

型号Type <sub>0</sub>	尺寸(mm) <sub>0</sub>	
	A <sub>0</sub>	R <sub>0</sub>
XD-XH-2AWT/LI <sub>0</sub>	2.50 <sub>0</sub>	7.50 <sub>0</sub>
XD-XH-3AWT/LT <sub>0</sub>	5.00 <sub>0</sub>	10.00 <sub>0</sub>
XD-XH-4AWT/LT <sub>0</sub>	7.50 <sub>0</sub>	12.50 <sub>0</sub>
XD-XH-5AWT/LT <sub>0</sub>	10.00 <sub>0</sub>	15.00 <sub>0</sub>
XD-XH-6AWT/LT <sub>0</sub>	12.50 <sub>0</sub>	17.50 <sub>0</sub>
XD-XH-7AWT/LT <sub>0</sub>	15.00 <sub>0</sub>	20.00 <sub>0</sub>
XD-XH-8AWT/LI <sub>0</sub>	17.50 <sub>0</sub>	22.50 <sub>0</sub>
XD-XH-20AWTLI <sub>0</sub>	47.50 <sub>0</sub>	52.50 <sub>0</sub>

# 材料 MATERIAL

端子 Terminal: Phosphor bronz

孔座 Housing: Nylon66 UL94V-0

针座 Wafer: Nylon66 UL94V-0

针座(立/卧贴) Wafer: LCP UL94V-0

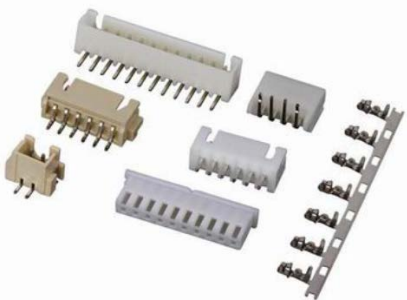

# 主要技术特征 MAIN SPECIFICATIONS

间距 Pitch: 2.5mm

线数 Poles: 2~20

适用线规 APPLICable Wire: AWG#22- #28

适用基板厚度 APPLICable PC board thickness: 1.6mm

温度范围 Temperatuer Range: -25°C~ +85°C

额定电压 Voltage Rating: 250V AC, DC

额定电流 Current Rating: 3A AC, DC

接触电阻 Contract Resistance: 20mΩ Max

绝缘电阻 Insulation Resistance: 1000mΩ Min

耐压 Withstanding Voltang: 1000V

# XD-XHB 系列

● Housing

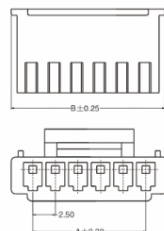

XD-XHB-Y

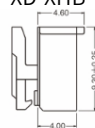

● Wafer

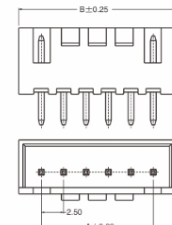

XD-XHB-NA

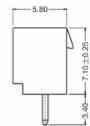

● Wafer

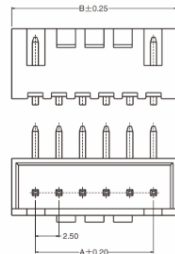

XD-XHB-NA

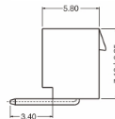

● Wafer

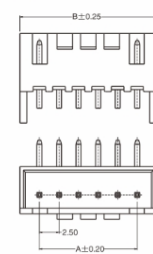

XD-XHB-NAWD



# 材料 MATERIAL

端子 Terminal: Phosphor bronz

孔座 Housing: Nylon66 UL94V-0

针座 Wafer: Nylon66 UL94V-0

针座(立/卧贴) Wafer: LCP UL94V-0



● Housing

型号 Type	尺寸 (mm)	
	A	B
XD-XHB-2Y	25.00	7.50
XD-XHB-3Y	5.00	10.00
XD-XHB-4Y	7.50	12.50
XD-XHB-5Y	10.00	15.00
XD-XHB-6Y	12.50	17.50
XD-XHB-7Y	15.00	20.00
XD-XHB-8Y	17.50	22.50
XD-XHB-9Y	20.00	25.00
XD-XHB-10Y	22.50	27.50
XD-XHB-11Y	25.00	30.00
XD-XHB-12Y	27.50	32.50
XD-XHB-13Y	30.00	35.00
XD-XHB-14Y	32.50	37.50
XD-XHB-15Y	35.00	40.00
XD-XHB-16Y	37.50	42.50
XD-XHB-20Y	47.50	52.50

● Wafer

型号 Type	尺寸 (mm)	
	A	B
XD-XHB-2A/AW/D; HC-HA-2AWT/LT	25.00	7.50
XD-XHB-3A/AW/D; HC-HA-3AWT/LT	5.00	10.00
XD-XHB-4A/AW/D; HC-HA-4AWT/LT	7.50	12.50
XD-XHB-5A/AW/D; HC-HA-5AWT/LT	10.00	15.00
XD-XHB-6A/AW/D; HC-HA-6AWT/LT	12.50	17.50
XD-XHB-7A/AW/D; HC-HA-7AWT/LT	15.00	20.00
XD-XHB-8A/AW/D; HC-HA-8AWT/LT	17.50	22.50
XD-XHB-9A/AW/D; HC-HA-9AWT/LT	20.00	25.00
XD-XHB-10A/AW/D; HC-HA-10AWT/LT	22.50	27.50
XD-XHB-11A/AW/D; HC-HA-11AWT/LT	25.00	30.00
XD-XHB-12A/AW/D; HC-HA-12AWT/LT	27.50	32.50
XD-XHB-13A/AW/D; HC-HA-13AWT/LT	30.00	35.00
XD-XHB-14A/AW/D; HC-HA-14AWT/LT	32.50	37.50
XD-XHB-15A/AW/D; HC-HA-15AWT/LT	35.00	40.00
XD-XHB-16A/AW/D; HC-HA-16AWT/LT	37.50	42.50
XD-XHB-20A/AW/D; HC-HA-20AWT/LT	47.50	52.50

# 主要技术特征 MAIN SPECIFICATIONS

间距 Pitch: 2.5mm

线数 Poles: 2~20

适用线规 APplicable Wire: AWG#22- #30

适用基板厚度 APplicable PC board thickness: 1.6mm

温度范围 Temperatuer Range: -25°C~ +85°C

额定电压 Voltage Rating: 250V AC, DC

额定电流 Current Rating: 3A AC, DC

接触电阻 Contract Resistance: 30mΩ Max

绝缘电阻 Insulation Resistance: 1000mΩ Min

耐压 Withstanding Voltang: 800V

# 材料 MATERIAL

端子 Terminal: Phosphor bronz

孔座 Housing: Nylon66 UL94V-0

针座 Wafer: Nylon66 UL94V-0



# XD-XHD 系列 (1)

## Terminal

XD-XHD-T

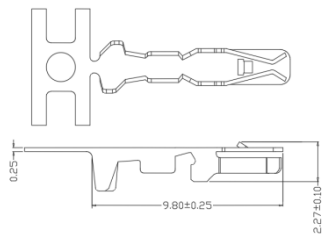

## Housing

XD-XHD-NY

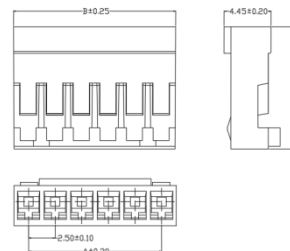

## Wafer

XD-XHD-NA

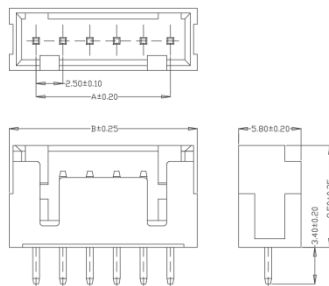

## Wafer

XD-XHD-NAW

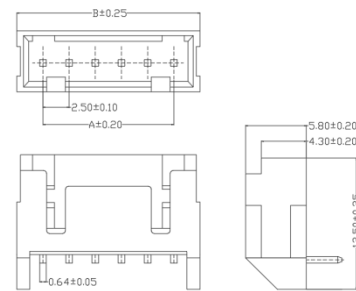

## Wafer

XD-XHD-2xNY

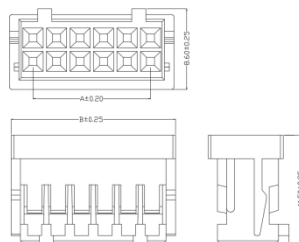



## 主要技术特征 MAIN SPECIFICATIONS

间距 Pitch: 2.5mm

线数 Poles: 2~20

适用线规 APPLICable Wire: AWG#22- #30

适用基板厚度 APPLICable PC board thickness: 1.6mm

温度范围 Temperatuer Range: -25°C~ +85°C

额定电压 Voltage Rating: 250V AC, DC

额定电流 Current Rating: 3A AC, DC

接触电阻 Contract Resistance: 30mΩ Max

绝缘电阻 Insulation Resistance: 1000mΩ Min

耐压 Withstanding Voltang: 800V

## 材料 MATERIAL

端子 Terminal: Phosphor bronz

孔座 Housing: Nylon66 UL94V-0

针座 Wafer: Nylon66 UL94V-0

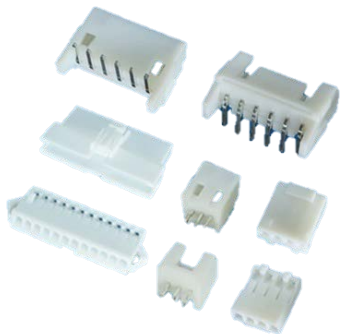

## XD-XHD 系列 (2)

### ● Wafer

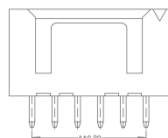
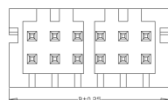

XD-XHD-  
2xNA

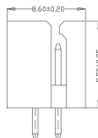

### ● Wafer

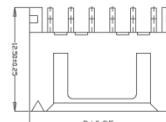
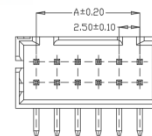

XD-XHD-  
2xNAW

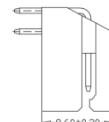

### ● Housing

型号Type.	尺寸 (mm)	
	A.	B.
XD-XHD-2Y.	2.50.	5.25.
XD-XHD-3Y.	5.00.	7.75.
XD-XHD-4Y.	7.50.	10.25.
XD-XHD-5Y.	10.00.	12.75.
XD-XHD-6Y.	12.50.	15.25.
XD-XHD-7Y.	15.00.	17.75.
XD-XHD-8Y.	17.50.	20.25.
XD-XHD-12Y.	27.50.	30.25.

### ● Wafer

型号Type.	尺寸 (mm)	
	A.	B.
XD-XHD-2A/AW.	2.50.	7.50.
XD-XHD-3A/AW.	5.00.	10.00.
XD-XHD-4A/AW.	7.50.	12.50.
XD-XHD-5A/AW.	10.00.	15.00.
XD-XHD-6A/AW.	12.50.	17.50.
XD-XHD-7A/AW.	15.00.	20.00.
XD-XHD-8A/AW.	17.50.	22.50.
XD-XHD-12A/AW.	27.50.	32.50.

### ● Wafer

型号Type.	尺寸 (mm)	
	A.	B.
XD-XHD-2x2A/AW/Y.	2.50.	7.50.
XD-XHD-2x3A/AW/Y.	5.00.	10.00.
XD-XHD-2x4A/AW/Y.	7.50.	12.50.
XD-XHD-2x5A/AW/Y.	10.00.	15.00.
XD-XHD-2x6A/AW/Y.	12.50.	17.50.
XD-XHD-2x7A/AW/Y.	15.00.	20.00.
XD-XHD-2x8A/AW/Y.	17.50.	22.50.
XD-XHD-2x12A/AW/Y.	27.50.	32.50.

## 主要技术特征 MAIN SPECIFICATIONS

间距 Pitch: 2.5mm

线数 Poles: 2~15

适用线规 APPLICable Wire: AWG#22- #28

适用基板厚度 APPLICable PC board thickness: 1.6mm

温度范围 Temperatuer Range: -25°C~ +85°C

额定电压 Voltage Rating: 250V AC, DC

额定电流 Current Rating: 3A AC, DC

接触电阻 Contract Resistance: 20mΩ Max

绝缘电阻 Insulation Resistance: 1000mΩ Min

耐压 Withstanding Voltang: 1000V

## 材料 MATERIAL

端子 Terminal: Phosphor bronz

孔座 Housing: Nylon66 UL94V-0

针座 Wafer: Nylon66 UL94V-0

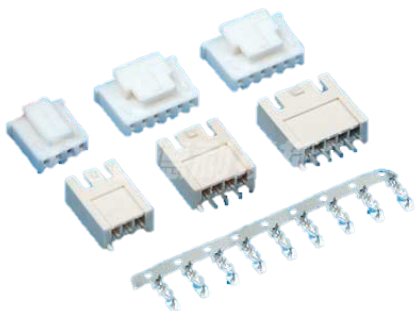

## XD-XHL 系列

### Terminal XD-XHL-T

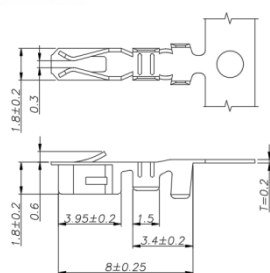

### Housing XD-XHL-NY-X

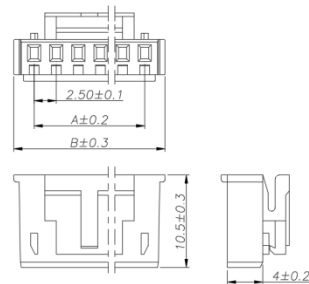

### Wafer XD-XHL-NA-X

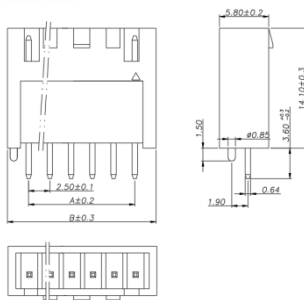

### Housing

型号Type.	尺寸(mm).	
	A.	B.
XD-XHL-2Y-X.	2.50.	7.00.
XD-XHL-3Y-X.	5.00.	9.50.
XD-XHL-4Y-X.	7.50.	12.00.
XD-XHL-5Y-X.	10.00.	14.50.
XD-XHL-6Y-X.	12.50.	17.00.
XD-XHL-7Y-X.	15.00.	19.50.
XD-XHL-8Y-X.	17.50.	22.00.
XD-XHL-15Y-X.	35.00.	39.50.

### Wafer

型号Type.	尺寸(mm).	
	A.	B.
XD-XHL-2A-X.	2.50.	7.50.
XD-XHL-3A-X.	5.00.	10.00.
XD-XHL-4A-X.	7.50.	12.50.
XD-XHL-5A-X.	10.00.	15.00.
XD-XHL-6A-X.	12.50.	17.50.
XD-XHL-7A-X.	15.00.	20.00.
XD-XHL-8A-X.	17.50.	22.50.
XD-XHL-15A-X.	35.00.	40.00.

# 主要技术特征 MAIN SPECIFICATIONS

间距 Pitch: 2.5mm

线数 Poles: 2~40

适用线规 APPLICable Wire: AWG#22- #28

适用基板厚度 APPLICable PC board thickness: 1.6mm

温度范围 Temperatuer Range: -25°C~ +85°C

额定电压 Voltage Rating: 250V AC, DC

额定电流 Current Rating: 3A AC, DC

接触电阻 Contact Resistance: 20mΩ Max

绝缘电阻 Insulation Resistance: 1000mΩ Min

耐压 Withstanding Voltang: 1000V

# 材料 MATERIAL

端子 Terminal: Phosphor bronz

孔座 Housing: Nylon66 UL94V-0

针座 Wafer: Nylon66 UL94V-0

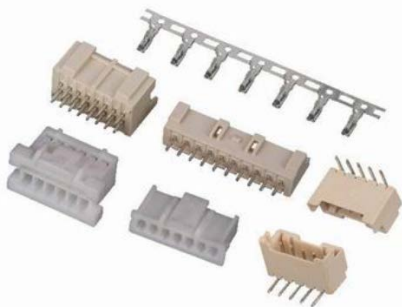

# XD-XA 系列

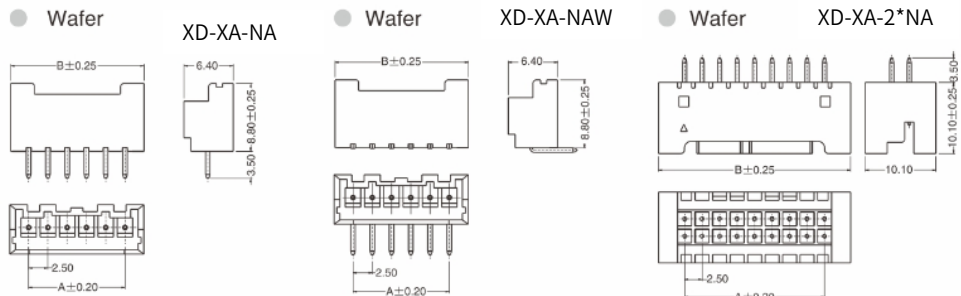
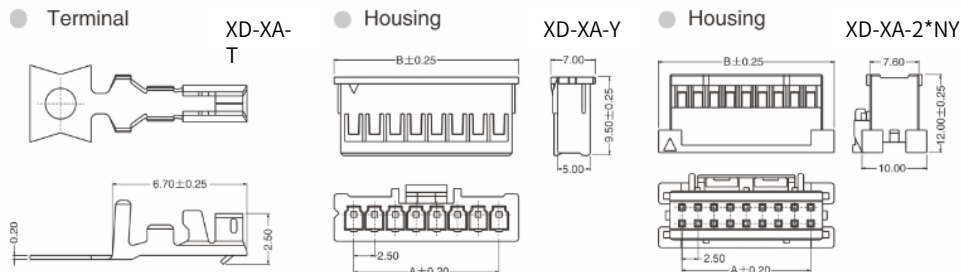

## ● Housing

型号 Type	尺寸 (mm)	
	A	B
XD-XA-2Y/2A/AW	2.50	7.50
XD-XA-3Y/3A/AW	5.00	10.00
XD-XA-4Y/4A/AW	7.50	12.50
XD-XA-5Y/5A/AW	10.00	15.00
XD-XA-6Y/6A/AW	12.50	17.50
XD-XA-7Y/7A/AW	15.00	20.00
XD-XA-8Y/8A/AW	17.50	22.50
XD-XA-20Y/20A/AW	47.50	52.50

## ● Wafer

型号 Type	尺寸 (mm)	
	A	B
XD-XA-2*4Y/4A	7.50	15.00
XD-XA-2*5Y/5A	10.00	17.50
XD-XA-2*6Y/6A	12.50	20.00
XD-XA-2*7Y/7A	15.00	22.50
XD-XA-2*8Y/8A	17.50	25.00
XD-XA-2*9Y/9A	20.00	27.50
XD-XA-2*10Y/10A	22.50	30.00
XD-XA-2*20Y/20A	47.50	55.00

# 主要技术特征 MAIN SPECIFICATIONS

间距 Pitch: 2.5mm

线数 Poles: 2~12

适用线规 APPLICable Wire: AWG#22- #30

适用基板厚度 APPLICable PC board thickness: 1.6mm

温度范围 Temperatuer Range: -25°C~ +85°C

额定电压 Voltage Rating: 250V AC, DC

额定电流 Current Rating: 3A AC, DC

接触电阻 Contract Resistance: 30mΩ Max

绝缘电阻 Insulation Resistance: 1000mΩ Min

耐压 Withstanding Voltang: 800V

# 材料 MATERIAL

端子 Terminal: Phosphor bronz

孔座 Housing: Nylon66 UL94V-0

针座 Wafer: Nylon66 UL94V-0

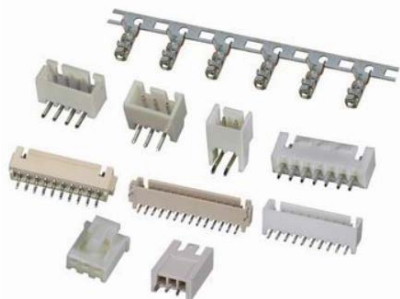

# XD-HA 系列

## Terminal

XD-HA-T

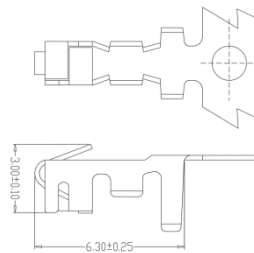

## Housing

XD-HA-NY

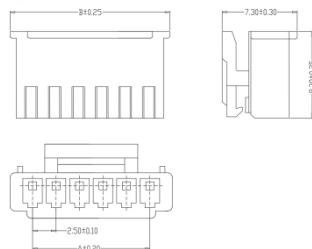

## Wafer

XD-HA-NALT

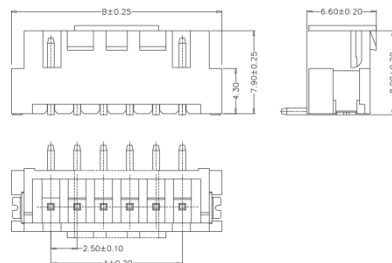

## Wafer

XD-HA-NIAWT

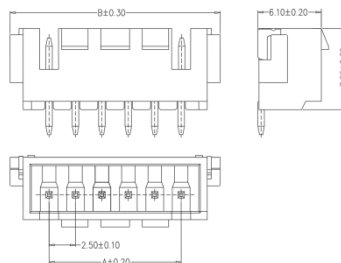

## Housing

型号Type	尺寸 (mm)	
	A	B
XD-HA-2Y	2.50	6.80
XD-HA-3Y	5.00	9.30
XD-HA-4Y	7.50	11.80
XD-HA-5Y	10.00	14.30
XD-HA-6Y	12.50	16.80
XD-HA-7Y	15.00	19.30
XD-HA-8Y	17.50	21.80
XD-HA-12Y	27.50	31.80

## Wafer

型号Type	尺寸 (mm)	
	A	B
XD-HA-2ALT/AWT	2.50	10.00
XD-HA-3ALT/AWT	5.00	12.50
XD-HA-4ALT/AWT	7.50	15.00
XD-HA-5ALT/AWT	10.00	17.50
XD-HA-6ALT/AWT	12.50	20.00
XD-HA-7ALT/AWT	15.00	22.50
XD-HA-8ALT/AWT	17.50	27.50
XD-HA-12ALT/AWT	27.50	35.00

# 主要技术特征 MAIN SPECIFICATIONS

间距 Pitch: 2.5mm

线数 Poles: 2~20

适用线规 APPLICable Wire: AWG#22- #28

适用基板厚度 APPLICable PC board thickness: 1.6mm

温度范围 Temperatuer Range: -25°C~ +85°C

额定电压 Voltage Rating: 250V AC, DC

额定电流 Current Rating: 3A AC, DC

接触电阻 Contract Resistance: 20mΩ Max

绝缘电阻 Insulation Resistance: 1000mΩ Min

耐压 Withstanding Voltang: 1000V

# XD-5264 系列

● Terminal XD-5264-T

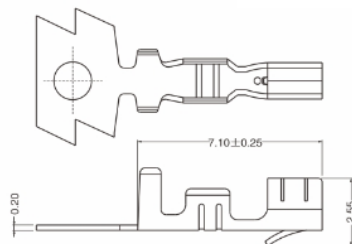

● Housing XD-5264-Y

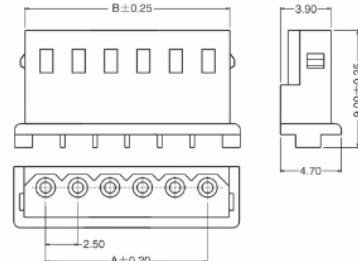

● Wafer XD-5264-NA

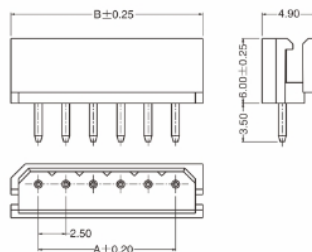

● Wafer XD-5264-NAW

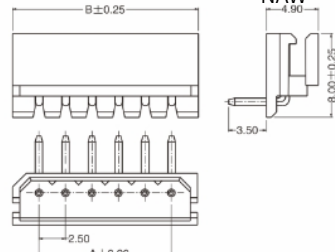

# 材料 MATERIAL

端子 Terminal: Phosphor bronz

孔座 Housing: Nylon66 UL94V-0

针座 Wafer: Nylon66 UL94V-0



● Housing

型号 Type <sup>①</sup>	尺寸 (mm) <sup>②</sup>	
	A <sup>③</sup>	B <sup>④</sup>
XD-5264-2Y <sup>⑤</sup>	2.50 <sup>⑥</sup>	5.80 <sup>⑦</sup>
XD-5264-3Y <sup>⑤</sup>	5.00 <sup>⑥</sup>	8.30 <sup>⑦</sup>
XD-5264-4Y <sup>⑤</sup>	7.50 <sup>⑥</sup>	10.80 <sup>⑦</sup>
XD-5264-5Y <sup>⑤</sup>	10.00 <sup>⑥</sup>	13.30 <sup>⑦</sup>
XD-5264-6Y <sup>⑤</sup>	12.50 <sup>⑥</sup>	15.80 <sup>⑦</sup>
XD-5264-7Y <sup>⑤</sup>	15.00 <sup>⑥</sup>	18.30 <sup>⑦</sup>
XD-5264-8Y <sup>⑤</sup>	17.50 <sup>⑥</sup>	20.80 <sup>⑦</sup>
XD-5264-20Y <sup>⑤</sup>	47.50 <sup>⑥</sup>	50.80 <sup>⑦</sup>

● Wafer

型号 Type <sup>①</sup>	尺寸 (mm) <sup>②</sup>	
	A <sup>③</sup>	B <sup>④</sup>
XD-5264-2A/AW <sup>⑤</sup>	2.50 <sup>⑥</sup>	7.50 <sup>⑦</sup>
XD-5264-3A/AW <sup>⑤</sup>	5.00 <sup>⑥</sup>	10.00 <sup>⑦</sup>
XD-5264-4A/AW <sup>⑤</sup>	7.50 <sup>⑥</sup>	12.50 <sup>⑦</sup>
XD-5264-5A/AW <sup>⑤</sup>	10.00 <sup>⑥</sup>	15.00 <sup>⑦</sup>
XD-5264-6A/AW <sup>⑤</sup>	12.50 <sup>⑥</sup>	17.50 <sup>⑦</sup>
XD-5264-7A/AW <sup>⑤</sup>	15.00 <sup>⑥</sup>	20.00 <sup>⑦</sup>
XD-5264-8A/AW <sup>⑤</sup>	17.50 <sup>⑥</sup>	22.50 <sup>⑦</sup>
XD-5264-20A/AW <sup>⑤</sup>	47.50 <sup>⑥</sup>	52.50 <sup>⑦</sup>

# 主要技术特征 MAIN SPECIFICATIONS

间距 Pitch: 2.5mm

线数 Poles: 2~20

适用线规 APPLICable Wire: AWG#22- #28

适用基板厚度 APPLICable PC board thickness: 1.6mm

温度范围 Temperatuer Range: -25°C~ +85°C

额定电压 Voltage Rating: 250V AC, DC

额定电流 Current Rating: 3A AC, DC

接触电阻 Contract Resistance: 20mΩ Max

绝缘电阻 Insulation Resistance: 1000mΩ Min

耐压 Withstanding Voltang: 1000V

# 材料 MATERIAL

端子 Terminal: Phosphor bronz

孔座 Housing: Nylon66 UL94V-0

针座 Wafer: Nylon66 UL94V-0



# XD-XAD 系列

● Terminal

XD-XAD-T-05

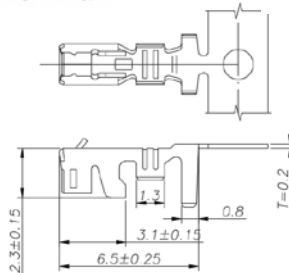

● Housing

XD-XAD-2xNY-05

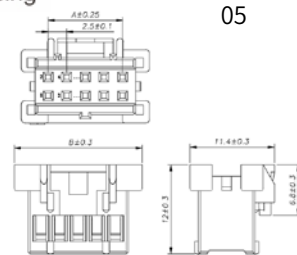

● Wafer

XD-XAD-2xNA-05

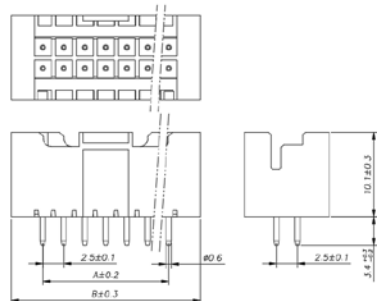

● Wafer

XD-XHD-2xNAWD-05

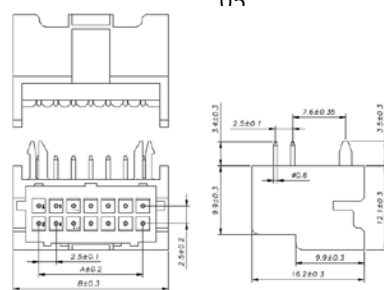

● Wafer

XD-XAD-2xNY

# 主要技术特征 MAIN SPECIFICATIONS

间距 Pitch: 2.54mm

线数 Poles: 2~20

适用线规 APPLICable Wire: AWG#24- #30

适用基板厚度 APPLICable PC board thickness: 1.6mm

温度范围 Temperatuer Range: -25°C~ +85°C

额定电压 Voltage Rating: 250V AC, DC

额定电流 Current Rating: 4A AC, DC

接触电阻 Contract Resistance: 20mΩ Max

绝缘电阻 Insulation Resistance: 1000mΩ Min

耐压 Withstanding Voltang: 1000V

# XD-2510 系列

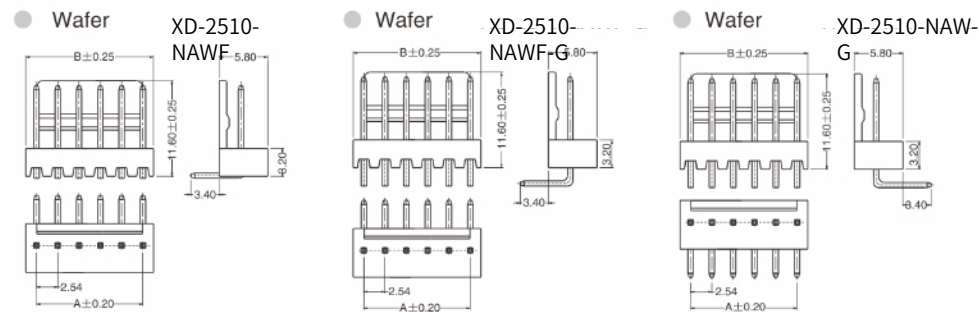
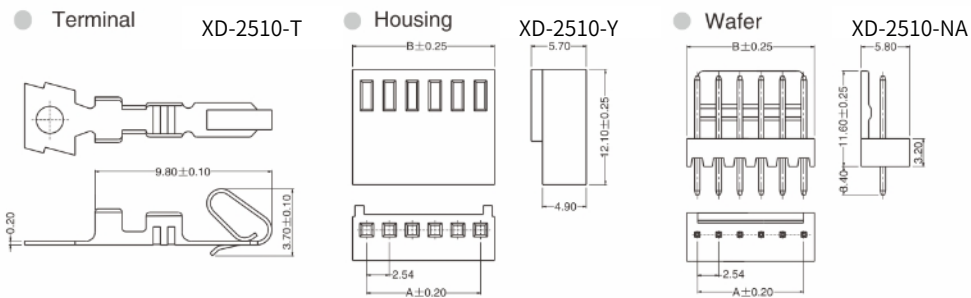

## ● Housing

型号 Type	尺寸 (mm)	
	A	B
XD-2510-2Y	2.54	5.68
XD-2510-3Y	5.08	8.22
XD-2510-4Y	7.62	10.76
XD-2510-5Y	10.16	13.30
XD-2510-6Y	12.70	15.84
XD-2510-7Y	15.24	18.38
XD-2510-8Y	17.78	20.92
XD-2510-20Y	48.26	51.40

## ● Wafer

型号 Type	尺寸 (mm)	
	A	B
XD-2510-2A/AWF/AWF-G/AW-G	2.54	5.08
XD-2510-3A/AWF/AWF-G/AW-G	5.08	7.62
XD-2510-4A/AWF/AWF-G/AW-G	7.62	10.16
XD-2510-5A/AWF/AWF-G/AW-G	10.16	12.70
XD-2510-6A/AWF/AWF-G/AW-G	12.70	15.24
XD-2510-7A/AWF/AWF-G/AW-G	15.24	17.78
XD-2510-8A/AWF/AWF-G/AW-G	17.78	20.32
XD-2510-20A/AWF/AWF-G/AW-G	48.26	50.80

# 材料 MATERIAL

端子 Terminal: Phosphor bronz

孔座 Housing: Nylon66 UL94V-0

针座 Wafer: Nylon66 UL94V-0



## 主要技术特征 MAIN SPECIFICATIONS

间距 Pitch: 2.54mm

线数 Poles: 2~30

适用线规 APPLICable Wire: AWG#22- #28

适用基板厚度 APPLICable PC board thickness: 1.6mm

温度范围 Temperatuer Range: -25°C~ +85°C

额定电压 Voltage Rating: 250V AC, DC

额定电流 Current Rating: 2A AC, DC

接触电阻 Contract Resistance: 20mΩ Max

绝缘电阻 Insulation Resistance: 1000mΩ Min

耐压 Withstanding Voltang: 1500V

## XD-A2510 刺破系列

● Terminal

XD-A2510-T

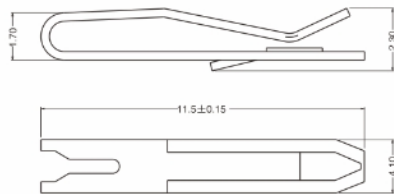

● Housing

XD-A2510-NY

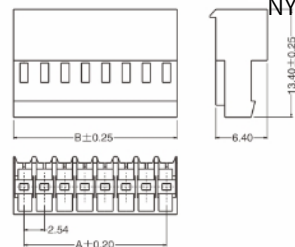

● Wafer

XD-A2510-NA

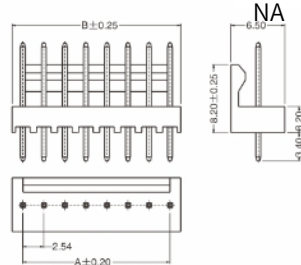

● Wafer

XD-A2510-NAW-G

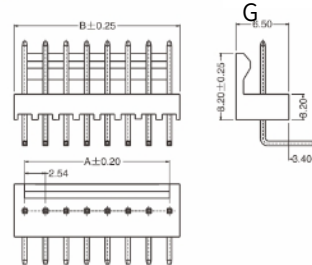

● Housing

● Wafer

## 材料 MATERIAL

端子 Terminal: Phosphor bronz

孔座 Housing: Nylon66 UL94V-0

针座 Wafer: Nylon66 UL94V-0

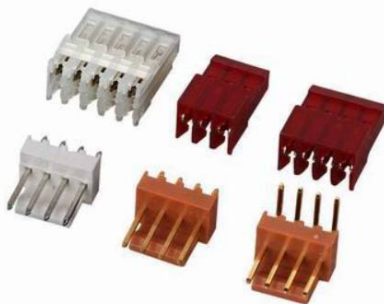

型号Type	尺寸 mm	
	A	B
XD-A2510-2Y	2.54	5.20
XD-A2510-3Y	5.08	7.72
HG A25104Y	7.62	10.28
XD-A2510-5Y	10.16	12.82
XD-A2510-6Y	12.70	15.36
XD-A2510-7Y	15.24	17.90
XD A2510 BY	17.78	20.44
XD-A2510-30Y	73.66	76.32

型号Type	尺寸 (mm)	
	A	B
XD-A2510-2A/AW-G	2.54	5.08
XD-A2510-3A/AW-G	5.08	7.72
XD-A2510-4A/AW-G	7.62	10.16
XD-A2510-5A/AW-G	10.16	12.70
XD-A2510-6A/AW-G	12.70	15.24
XD-A2510-7A/AW-G	15.24	17.78
XD-A2510-8A/AW-G	17.78	20.32
XD-A2510-30A/AW-C	73.66	76.20



## 3.00mm 系列

- 7 · 间距 PITCH: 3.00mm (53~55页)  
3.00双排条形连接器 XD-MX 系列

## 主要技术特征 MAIN SPECIFICATIONS

间距 Pitch: 3.0mm

线数 Poles: 2~24

适用线规 APPLICABLE Wire: AWG#20- #28

适用基板厚度 APPLICABLE PC board thickness: 1.6mm

温度范围 Temperatuer Range: -25°C~ +85°C

额定电压 Voltage Rating: 600V AC, DC

额定电流 Current Rating: 5A AC, DC

接触电阻 Contract Resistance: 20mΩ Max

绝缘电阻 Insulation Resistance: 1000mΩ Min

耐压 Withstanding Voltang: 1500V

## 材料 MATERIAL

端子 Terminal: Phosphor bronz

孔座 Housing: Nylon66 UL94V-0

针座 Wafer: Nylon66 UL94V-0



## XD-MX 系列(1)

Terminal

XD-MX-T

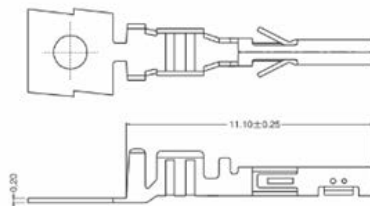

Terminal

XD-MX-PT

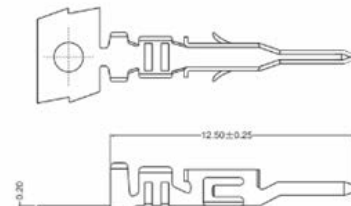

Housing

XD-MX-2xNY

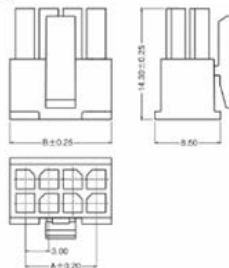

Housing

XD-MX-2xDY

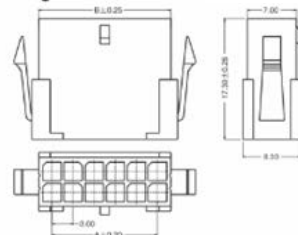

Wafer

XD-MX-2xNA

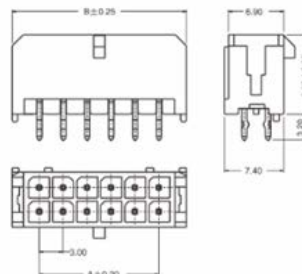

Wafer

XD-MX-2xNAW

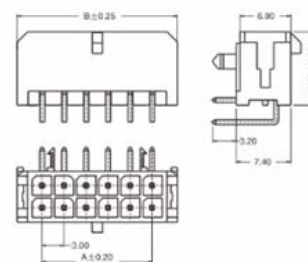

## 主要技术特征 MAIN SPECIFICATIONS

间距 Pitch: 3.0mm

线数 Poles: 2~24

适用线规 APPLICable Wire: AWG#20- #28

适用基板厚度 APPLICable PC board thickness: 1.6mm

温度范围 Temperatuer Range: -25°C~ +85°C

额定电压 Voltage Rating: 600V AC, DC

额定电流 Current Rating: 5A AC, DC

接触电阻 Contract Resistance: 20mΩ Max

绝缘电阻 Insulation Resistance: 1000mΩ Min

耐压 Withstanding Voltang: 1500V

## XD-MX 系列(2)

### ● Wafer

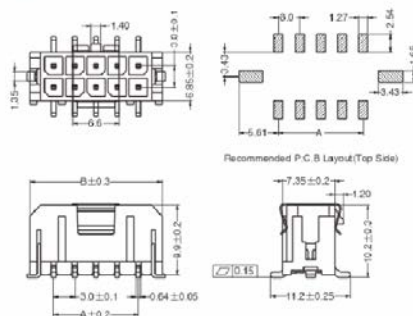

### ● Wafer

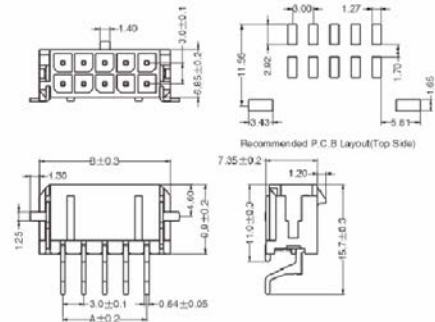

### ● Housing

型号Type	尺寸(mm)	
	A	B
XD-MX-2x2Y/DY	3.00	8.20
XD-MX-2x3Y/DY	6.00	11.20
XD-MX-2x4Y/DY	9.00	14.20
XD-MX-2x5Y/DY	12.00	17.20
XD-MX-2x6Y/DY	15.00	20.20
XD-MX-2x7Y/DY	18.00	23.20
XD-MX-2x8Y/DY	21.00	26.20
XD-MX-2x12Y/DY	33.00	38.20

### ● Wafer

型号Type	尺寸(mm)	
	A	B
XD-MX-2x2A/AW/ALT/AWT	3.00	9.00
XD-MX-2x3A/AW/ALT/AWT	6.00	12.00
XD-MX-2x4A/AW/ALT/AWT	9.00	15.00
XD-MX-2x5A/AW/ALT/AWT	12.00	18.00
XD-MX-2x6A/AW/ALT/AWT	15.00	21.00
XD-MX-2x7A/AW/ALT/AWT	18.00	24.00
XD-MX-2x8A/AW/ALT/AWT	21.00	27.00
XD-MX-2x12A/AW/ALT/AWT	33.00	39.00

## 材料 MATERIAL

端子 Terminal: Phosphor bronz

孔座 Housing: Nylon66 UL94V-0

针座 Wafer: Nylon66 UL94V-0



## 3.81mm 系列

8

• 间距 PITCH: 3.81mm (56~57页)

3.81双排条形连接器 XD-MX 系列

# 主要技术特征 MAIN SPECIFICATIONS

间距 Pitch: 3.81mm

线数 Poles: 2~12

适用线规 APPLICable Wire: AWG#14- #24

适用基板厚度 APPLICable PC board thickness: 1.6mm

温度范围 Temperatuer Range: -25°C~ +85°C

额定电压 Voltage Rating: 250V AC, DC

额定电流 Current Rating: 15A AC, DC

接触电阻 Contract Resistance: 10mΩ Max

绝缘电阻 Insulation Resistance: 1000mΩ Min

耐压 Withstanding Voltang: 1500V

# 材料 MATERIAL

端子 Terminal: Phosphor bronz

孔座 Housing: PBT UL94V-0

针座 Wafer: PBT UL94V-0

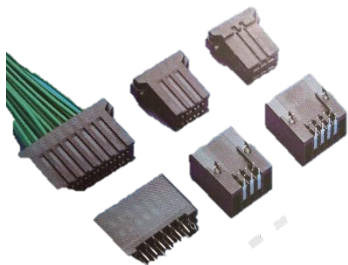

# XD-3.81 系列

- Terminal XD-3.81-T-05

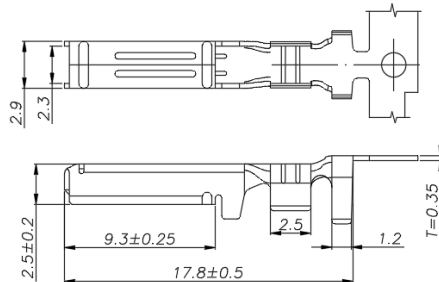

- Housing XD-3.81-2xNY-05

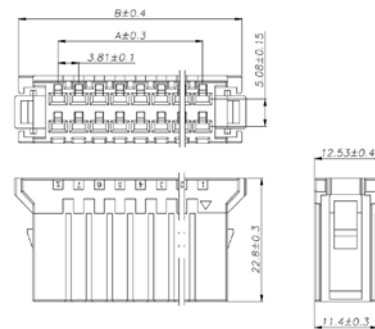

- Wafer XD-3.81-2xNA-05

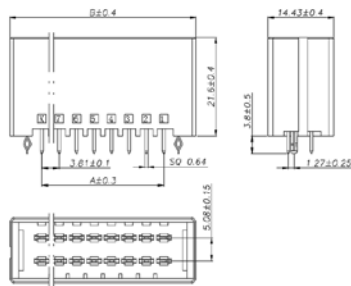

- Wafer XD-3.81-2xNAW-05

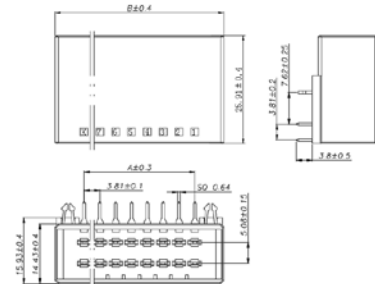

- Housing

型号 Type	尺寸 (mm)	
	A	B
XD-3.81-2x2Y-X-05	3.81	18.35
XD-3.81-2x3Y-X-05	7.62	22.16
XD-3.81-2x4Y-X-05	11.43	25.97
XD-3.81-2x5Y-X-05	15.24	29.78
XD-3.81-2x12Y-X-05	41.91	56.45

- Wafer

型号 Type	尺寸 (mm)	
	A	B
XD-3.81-2x2A/AW-X-05	3.81	17.81
XD-3.81-2x3A/AW-X-05	7.62	21.62
XD-3.81-2x4A/AW-X-05	11.43	25.43
XD-3.81-2x5A/AW-X-05	15.24	29.24
XD-3.81-2x12A/AW-X-05	41.91	55.91

## 3.96mm 系列

9

• 间距 PITCH: 3.96mm (58~63页)

3.96单排条形连接器 XD-3.96 系列

3.96单排条形连接器 XD-VH 系列

3.96单排条形连接器 XD-VHL 系列

3.96单排条形连接器 XD-VHH系列

# 主要技术特征 MAIN SPECIFICATIONS

间距 Pitch: 3.96mm

线数 Poles: 2~12

适用线规 APPLICable Wire: AWG#18- #24

适用基板厚度 APPLICable PC board thickness: 1.6mm

温度范围 Temperatuer Range: -25°C~ +85°C

额定电压 Voltage Rating: 250V AC, DC

额定电流 Current Rating: 6A AC, DC

接触电阻 Contract Resistance: 20mΩ Max

绝缘电阻 Insulation Resistance: 1000mΩ Min

耐压 Withstanding Voltang: 1500V

# XD-3.96 系列

● Terminal XD-3,96-T

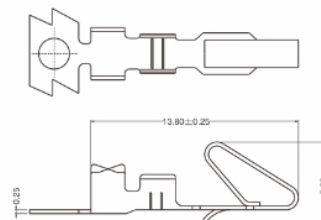

● Housing XD-3,96-Y

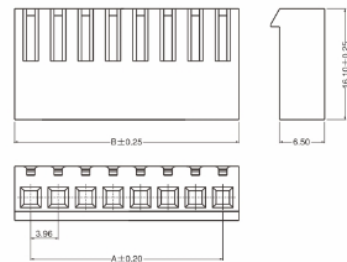

● Wafer XD-3,96-NA

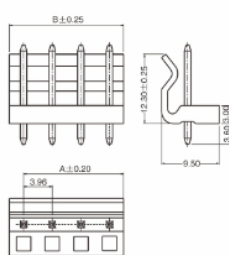

● Wafer XD-3,96-NAW

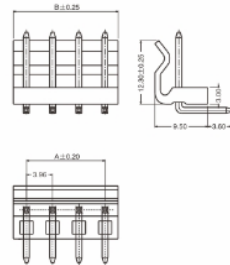

● Wafer XD-3,96-NAW-G

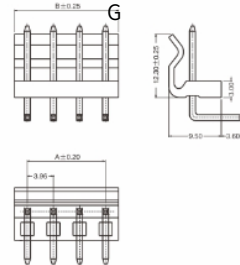

# 材料 MATERIAL

端子 Terminal: Phosphor bronz

孔座 Housing: Nylon66 UL94V-0

针座 Wafer: Nylon66 UL94V-0

● Housing

型号Type	尺寸 (mm)	
	A	B
XD-3.96-2Y	3.96	8.80
XD-3.96-3Y	7.92	12.76
XD-3.96-4Y	11.88	16.72
XD-3.96-5Y	15.84	20.68
XD-3.96-6Y	19.80	24.64
XD-3.96-7Y	23.76	28.60
XD-3.96-8Y	27.72	32.56
XD-3.96-9Y	31.68	36.52
XD-3.96-10Y	35.64	40.48
XD-3.96-11Y	39.60	44.44
XD-3.96-12Y	43.56	47.62

● Wafer

型号Type	尺寸 (mm)	
	A	B
XD-3.96-2A/AW/AW-G	3.96	7.92
XD-3.96-3A/AW/AW-G	7.92	11.88
XD-3.96-4A/AW/AW-G	11.88	15.84
XD-3.96-5A/AW/AW-G	15.84	19.80
XD-3.96-6A/AW/AW-G	19.80	23.76
XD-3.96-7A/AW/AW-G	23.76	27.72
XD-3.96-8A/AW/AW-G	27.72	31.68
XD-3.96-9A/AW/AW-G	31.68	35.64
XD-3.96-10A/AW/AW-G	35.64	39.60
XD-3.96-11A/AW/AW-G	39.60	43.56
XD-3.96-12A/AW/AW-G	43.56	47.52



## 主要技术特征 MAIN SPECIFICATIONS

间距 Pitch: 3.96mm

线数 Poles: 2~12

适用线规 APPLICable Wire: AWG#18- #22

适用基板厚度 APPLICable PC board thickness: 1.6mm

温度范围 Temperatuer Range: -25°C~ +85°C

额定电压 Voltage Rating: 250V AC, DC

额定电流 Current Rating: 7A AC, DC

接触电阻 Contract Resistance: 20mΩ Max

绝缘电阻 Insulation Resistance: 1000mΩ Min

耐压 Withstanding Voltang: 1500V

## 材料 MATERIAL

端子 Terminal: Phosphor bronz

孔座 Housing: Nylon66 UL94V-0

针座 Wafer: Nylon66 UL94V-0

针座(立/卧贴) Wafer: LCP UL94V-0 UL94V-0



## XD-VH 系列 (1)

### Terminal

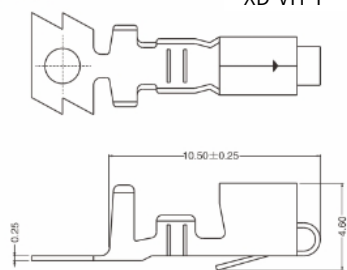

### Housing

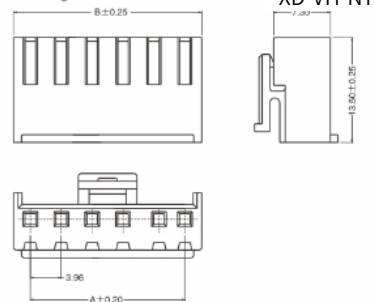

### Wafer

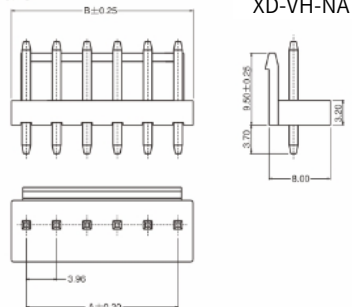

### Wafer

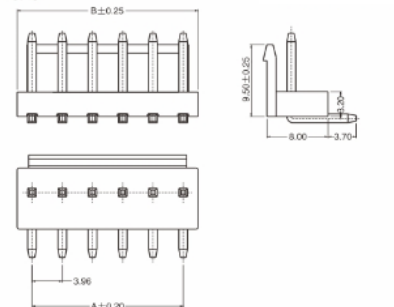



# 主要技术特征 MAIN SPECIFICATIONS

间距 Pitch: 3.96mm

线数 Poles: 2~12

适用线规 APPLICable Wire: AWG#18- #22

适用基板厚度 APPLICable PC board thickness: 1.6mm

温度范围 Temperatuer Range: -25°C~ +85°C

额定电压 Voltage Rating: 250V AC, DC

额定电流 Current Rating: 7A AC, DC

接触电阻 Contract Resistance: 20mΩ Max

绝缘电阻 Insulation Resistance: 1000mΩ Min

耐压 Withstanding Voltang: 1500V

# XD-VH 系列 (2)

● Wafer

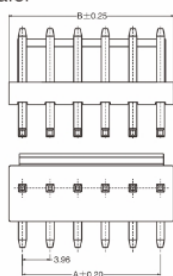

XD-VH-NAW-G

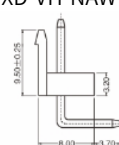

● Wafer

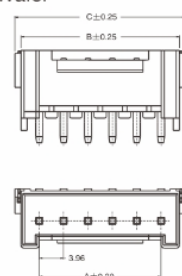

XD-VH-NAWT



● Wafer

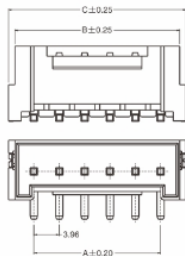

XD-VH-NALT

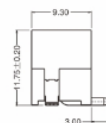

# 材料 MATERIAL

端子 Terminal: Phosphor bronz

孔座 Housing: Nylon66 UL94V-0

针座 Wafer: Nylon66 UL94V-0

针座(立/卧贴) Wafer: LCP UL94V-0 UL94V-0



● Housing

型号 Type	尺寸 (mm)	
	A	B
XD-VH-2Y	3.96	8.02
XD-VH-3Y	7.92	11.98
XD-VH-4Y	11.88	15.94
XD-VH-5Y	15.84	19.90
XD-VH-6Y	19.80	23.86
XD-VH-7Y	23.76	27.82
XD-VH-8Y	27.72	31.78
XD-VH-9Y	31.68	35.74
XD-VH-10Y	35.64	39.70
XD-VH-11Y	39.60	43.66
XD-VH-12Y	43.56	47.62

● Wafer

型号 Type	尺寸 (mm)	
	A	B
XD-VH-2A/AW/AW-G	3.96	7.92
XD-VH-3A/AW/AW-G	7.92	11.88
XD-VH-4A/AW/AW-G	11.88	15.84
XD-VH-5A/AW/AW-G	15.84	19.80
XD-VH-6A/AW/AW-G	19.80	23.76
XD-VH-7A/AW/AW-G	23.76	27.72
XD-VH-8A/AW/AW-G	27.72	31.68
XD-VH-9A/AW/AW-G	31.68	35.64
XD-VH-10A/AW/AW-G	35.64	39.60
XD-VH-11A/AW/AW-G	39.60	43.56
XD-VH-12A/AW/AW-G	43.56	47.52

● Wafer

型号 Type	尺寸 (mm)		
	A	B	C
XD-VH-2AWT/LT	3.96	9.90	11.88
XD-VH-3AWT/LT	7.92	13.86	15.84
XD-VH-4AWT/LT	11.88	17.82	19.80
XD-VH-5AWT/LT	15.84	21.78	23.76
XD-VH-6AWT/LT	19.80	25.74	27.72
XD-VH-7AWT/LT	23.76	29.70	31.68
XD-VH-8AWT/LT	27.72	33.66	35.64
XD-VH-9AWT/LT	31.68	37.62	39.60
XD-VH-10AWT/LT	35.64	41.58	43.56
XD-VH-11AWT/LT	39.60	45.54	47.52
XD-VH-12AWT/LT	43.56	49.50	51.48

# 主要技术特征 MAIN SPECIFICATIONS

间距 Pitch: 3.96mm

线数 Poles: 2~15

适用线规 APPLICable Wire: AWG#18- #22

适用基板厚度 APPLICable PC board thickness: 1.6mm

温度范围 Temperatuer Range: -25°C~ +85°C

额定电压 Voltage Rating: 250V AC, DC

额定电流 Current Rating: 7A AC, DC

接触电阻 Contract Resistance: 20mΩ Max

绝缘电阻 Insulation Resistance: 1000mΩ Min

耐压 Withstanding Voltang: 1500V

# 材料 MATERIAL

端子 Terminal: Phosphor bronz

孔座 Housing: Nylon66 UL94V-0

针座 Wafer: Nylon66 UL94V-0



# XD-VHL 系列

## Terminal XD-VHL-T

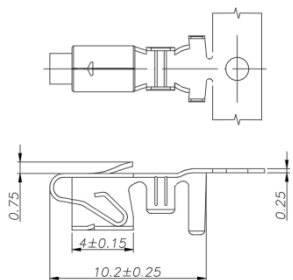

## Housing XD-VHL-NY-X

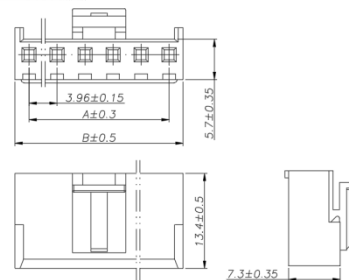

## Wafer XD-VHL-NA-X

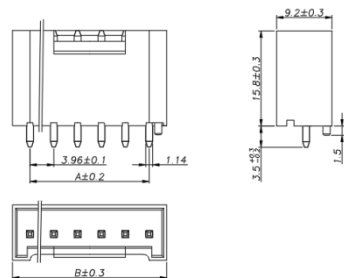

## Housing

型号Type	尺寸(mm)	
	A	B
XD-VHL-2Y-X	3.96	7.92
XD-VHL-3Y-X	7.92	11.88
XD-VHL-4Y-X	11.88	15.84
XD-VHL-5Y-X	15.84	19.80
XD-VHL-6Y-X	19.80	23.76
XD-VHL-7Y-X	23.76	27.72
XD-VHL-8Y-X	27.72	31.68
XD-VHL-15Y-X	55.44	59.40

## Wafer

型号Type	尺寸(mm)	
	A	B
XD-VHL-2A-X	3.96	8.80
XD-VHL-3A-X	7.92	13.76
XD-VHL-4A-X	11.88	17.72
XD-VHL-5A-X	15.84	21.68
XD-VHL-6A-X	19.80	25.64
XD-VHL-7A-X	23.76	29.60
XD-VHL-8A-X	27.72	33.56
XD-VHL-15A-X	55.44	61.28

# 主要技术特征 MAIN SPECIFICATIONS

间距 Pitch: 3.96mm

线数 Poles: 2~15

适用线规 APPLICable Wire: AWG#18- #22

适用基板厚度 APPLICable PC board thickness: 1.6mm

温度范围 Temperatuer Range: -25°C~ +85°C

额定电压 Voltage Rating: 250V AC, DC

额定电流 Current Rating: 7A AC, DC

接触电阻 Contract Resistance: 20mΩ Max

绝缘电阻 Insulation Resistance: 1000mΩ Min

耐压 Withstanding Voltang: 1500V

# 材料 MATERIAL

端子 Terminal: Phosphor bronz

孔座 Housing: Nylon66 UL94V-0

针座 Wafer: Nylon66 UL94V-0

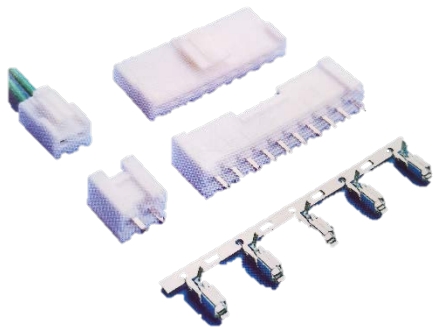

# XD-VHH系列

- Terminal XD-VHL-T (共享型号)

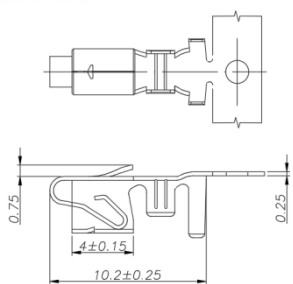

- Housing XD-VHL-NY-X (共享型号)

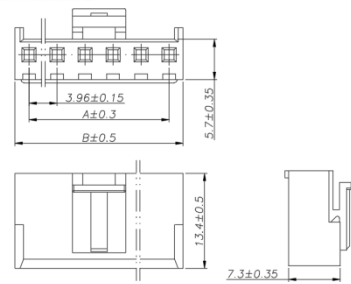

- Wafer XD-VHH-NA-X

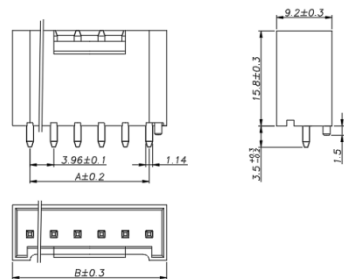

- Wafer XD-VHH-NAWD-X

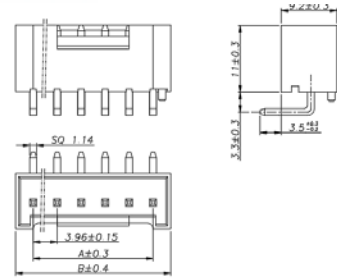

- Housing

型号Type	尺寸(mm)	
	A	B
XD-VHL-2Y-X	3.96	7.92
XD-VHL-3Y-X	7.92	11.88
XD-VHL-4Y-X	11.88	15.84
XD-VHL-5Y-X	15.84	19.80
XD-VHL-6Y-X	19.80	23.76
XD-VHL-7Y-X	23.76	27.72
XD-VHL-8Y-X	27.72	31.68
XD-VHL-15Y-X	55.44	59.40

- Wafer

型号Type	尺寸(mm)	
	A	B
XD-VHH-2A/AWD-X	3.96	9.80
XD-VHH-3A/AWD-X	7.92	13.76
XD-VHH-4A/AWD-X	11.88	17.72
XD-VHH-5A/AWD-X	15.84	21.68
XD-VHH-6A/AWD-X	19.80	25.64
XD-VHH-7A/AWD-X	23.76	29.60
XD-VHH-8A/AWD-X	27.72	33.56
XD-VHH-17A/AWD-X	63.36	69.20

## 4.20mm 系列

10

• 间距 PITCH: 4.20mm (64~67页)

4.20单、双排条形连接器 XD-5557 系列

4.20双排条形连接器 XD-5557R 系列

# 主要技术特征 MAIN SPECIFICATIONS

间距 Pitch: 4.20mm

线数 Poles: 2~24

适用线规 APPLICable Wire: AWG#20- #26

适用基板厚度 APPLICable PC board thickness: 1.6mm

温度范围 Temperatuer Range: -25°C~ +85°C

额定电压 Voltage Rating: 600V AC, DC

额定电流 Current Rating: 9A AC, DC

接触电阻 Contact Resistance: 20mΩ Max

绝缘电阻 Insulation Resistance: 1000mΩ Min

耐压 Withstanding Voltang: 1500V

# 材料 MATERIAL

端子 Terminal: Phosphor bronz

孔座 Housing: Nylon66 UL94V-0

针座 Wafer: Nylon66 UL94V-0



# XD-5557 系列 (1)

Terminal XD-5557-T

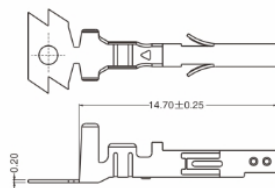

Terminal XD-5557-PT

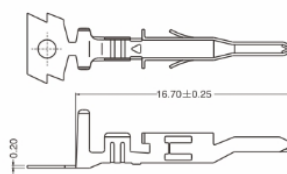

Housing XD-5557-NY

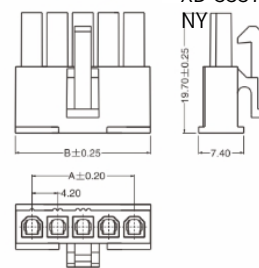

Housing XD-5557-EY

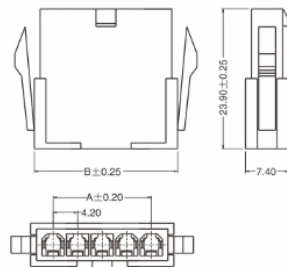

Wafer XD-5557-NA

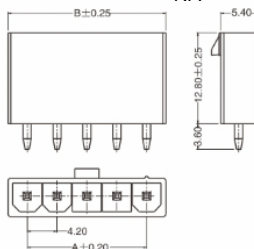

Wafer XD-5557-NAW

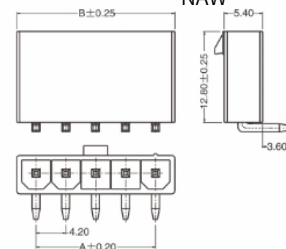

Housing

型号Type	尺寸 (mm)	
	A	B
XD-5557-2/2*2Y	4.20	9.60
XD-5557-3/2*3Y	8.40	13.80
XD-5557-4/2*4Y	12.60	18.00
XD-5557-12/2*12Y	46.20	51.60

Housing

型号Type	尺寸 (mm)	
	A	B
XD-5557-2/2*2EY	4.20	11.80
XD-5557-3/2*3EY	8.40	16.00
XD-5557-4/2*4EY	12.60	20.20
XD-5557-12/2*12EY	46.20	53.80

# 主要技术特征 MAIN SPECIFICATIONS

间距 Pitch: 4.20mm

线数 Poles: 2~24

适用线规 APPLICable Wire: AWG#20- #26

适用基板厚度 APPLICable PC board thickness: 1.6mm

温度范围 Temperatuer Range: -25°C~ +85°C

额定电压 Voltage Rating: 600V AC, DC

额定电流 Current Rating: 9A AC, DC

接触电阻 Contract Resistance: 20mΩ Max

绝缘电阻 Insulation Resistance: 1000mΩ Min

耐压 Withstanding Voltang: 1500V

# 材料 MATERIAL

端子 Terminal: Phosphor bronz

孔座 Housing: Nylon66 UL94V-0

针座 Wafer: Nylon66 UL94V-0

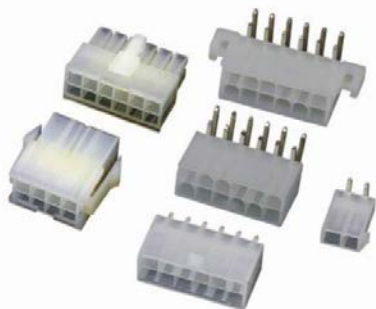

# XD-5557 系列 (2)

## ● Housing

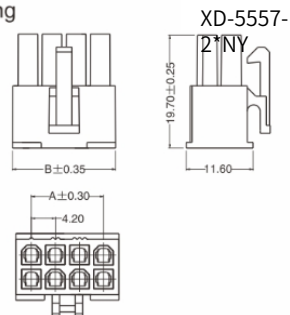

## ● Housing

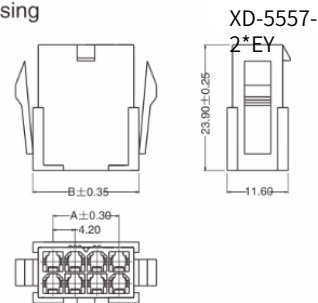

## ● Wafer

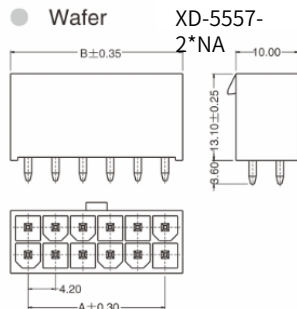

## ● Wafer

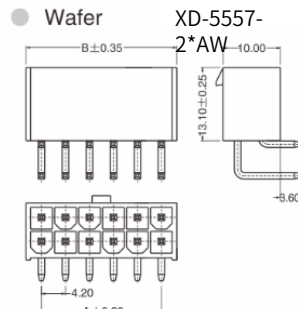

## ● Wafer

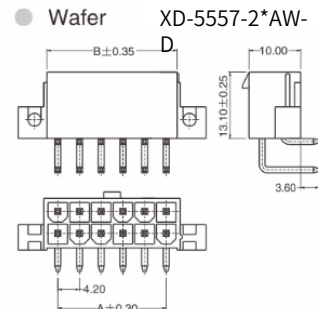

## ● Wafer

型号 Type	尺寸 (mm)	
	A	B
XD-5557-2A	4.20	9.60
XD-5557-3A	8.40	13.80
XD-5557-4A	12.60	18.00
XD-5557-5A	16.80	22.20

## ● Wafer

型号 Type	尺寸 (mm)	
	A	B
XD-5557-2*2A/ AW/ AW-D	4.20	9.60
XD-5557-2*3A/ AW/ AW-D	8.40	13.80
XD-5557-2*4A/ AW/ AW-D	12.60	18.00
XD-5557-2*5A/ AW/ AW-D	16.80	22.20
XD-5557-2*6A/ AW/ AW-D	21.00	26.40
XD-5557-2*12A/ AW/ AW-D	46.20	51.60

## 主要技术特征 MAIN SPECIFICATIONS

间距 Pitch: 4.20mm

线数 Poles: 2~24

适用线规 APPLICable Wire: AWG#20- #26

适用基板厚度 APPLICable PC board thickness: 1.6mm

温度范围 Temperatuer Range: -25°C~ +85°C

额定电压 Voltage Rating: 300V AC, DC

额定电流 Current Rating: 9A AC, DC

接触电阻 Contract Resistance: 20mΩ Max

绝缘电阻 Insulation Resistance: 1000mΩ Min

耐压 Withstanding Voltang: 1500V

## 材料 MATERIAL

端子 Terminal: Phosphor bronz

孔座 Housing: Nylon66 UL94V-0

针座 Wafer: Nylon66 UL94V-0

## XD-5557R 防水款 系列 (1)

### Terminal XD-5557R-T-05

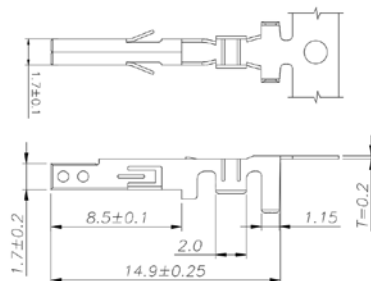

### Housing XD-5557R-2xNYF-05

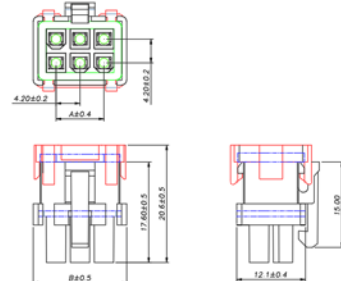

### Wafer XD-5557R-2xNA-05

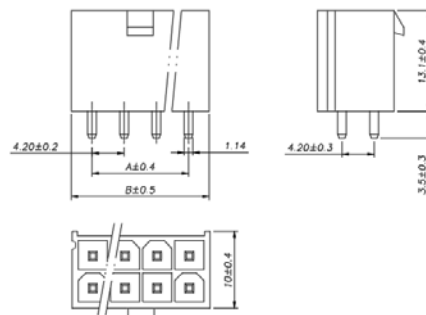

### Housing

型号Type	尺寸(mm)	
	A	B
XD-5557R-2x1YF-X-05		8.00
XD-5557R-2x2YF-X-05	4.20	12.20
XD-5557R-2x3YF-X-05	8.40	16.40
XD-5557R-2x4YF-X-05	12.60	20.60
XD-5557R-2x12YF-X-05	46.20	54.20

### Wafer

型号Type	尺寸(mm)	
	A	B
XD-5557R-2x1A-X-05		5.40
XD-5557R-2x2A-X-05	4.20	9.60
XD-5557R-2x3A-X-05	8.40	13.80
XD-5557R-2x4A-X-05	12.60	18.00
XD-5557R-2x12A-X-05	46.20	51.60

## 5.00mm 系列

11

• 间距 PITCH: 5.00mm (68~70页)

5.00单排条形连接器 XD-5003 系列

5.00单排条形连接器 XD-C2 系列



# 主要技术特征 MAIN SPECIFICATIONS

间距 Pitch: 5.00mm

线数 Poles: 2~12

适用线规 APPLICable Wire: AWG#16- #22

适用基板厚度 APPLICable PC board thickness: 1.6mm

温度范围 Temperatuer Range: -25°C~ +85°C

额定电压 Voltage Rating: 250V AC, DC

额定电流 Current Rating: 10A AC, DC

接触电阻 Contract Resistance: 20mΩ Max

绝缘电阻 Insulation Resistance: 1000mΩ Min

耐压 Withstanding Voltang: 1500V

## 材料 MATERIAL

端子 Terminal: Phosphor bronz

孔座 Housing: Nylon66 UL94V-0

针座 Wafer: Nylon66 UL94V-0

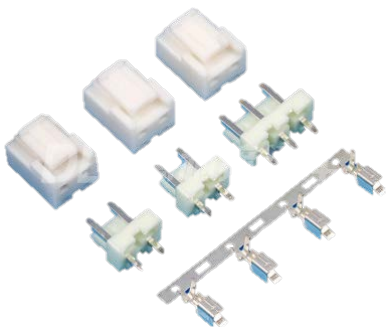

## XD-5003系列

### Terminal XD-5003-T

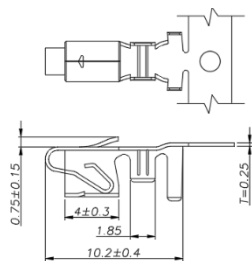

### Housing XD-5003-NY

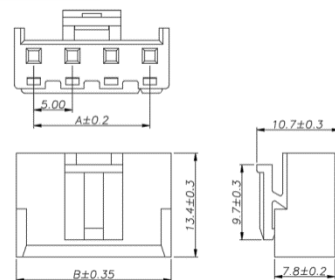

### Wafer XD-5003-NA

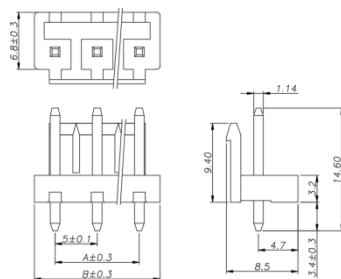

### Wafer XD-5003-NAW-G

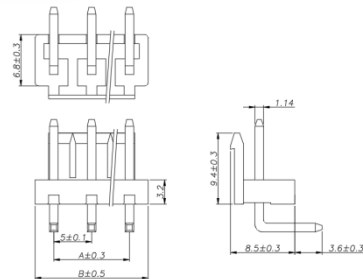

### Housing

型号Type	尺寸(mm)	
	A	B
XD-5003-2Y	5.00	10.00
XD-5003-3Y	10.00	15.00
XD-5003-4Y	15.00	20.00
XD-5003-5Y	20.00	25.00
XD-5003-6Y	25.00	30.00
XD-5003-7Y	30.00	35.00
XD-5003-8Y	35.00	40.00
XD-5003-12Y	55.00	60.00

### Wafer

型号Type	尺寸(mm)	
	A	B
XD-5003-2A/AW-G	5.00	10.00
XD-5003-3A/AW-G	10.00	15.00
XD-5003-4A/AW-G	15.00	20.00
XD-5003-5A/AW-G	20.00	25.00
XD-5003-6A/AW-G	25.00	30.00
XD-5003-7A/AW-G	30.00	35.00
XD-5003-8A/AW-G	35.00	40.00
XD-5003-12A/AW-G	55.00	60.00

## 主要技术特征 MAIN SPECIFICATIONS

间距 Pitch: 5.00mm

线数 Poles: 2~6

适用线规 APPLICable Wire: AWG#20- #26

适用基板厚度 APPLICable PC board thickness: 1.6mm

温度范围 Temperatuer Range: -25°C~ +85°C

额定电压 Voltage Rating: 250V AC, DC

额定电流 Current Rating: 4A AC, DC

接触电阻 Contact Resistance: 10mΩ Max

绝缘电阻 Insulation Resistance: 1000mΩ Min

耐压 Withstanding Voltang: 1500V

## 材料 MATERIAL

端子 Terminal: Phosphor bronz

孔座 Housing: Nylon66 UL94V-0

针座 Wafer: PBT UL94V-0

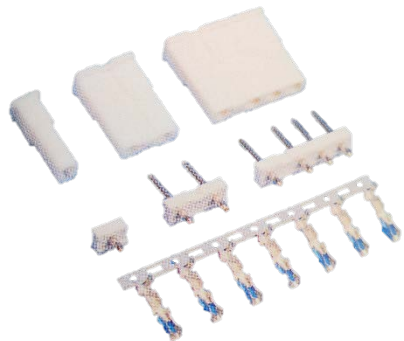

## XD-C2系列

### Terminal XD-C2-T-05

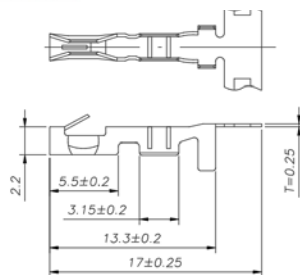

### Housing XD-C2-NY-05

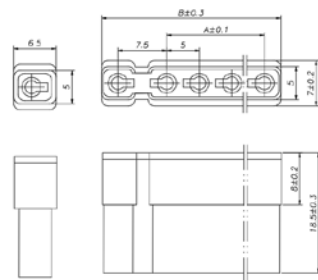

### Wafer XD-C2-NA-05

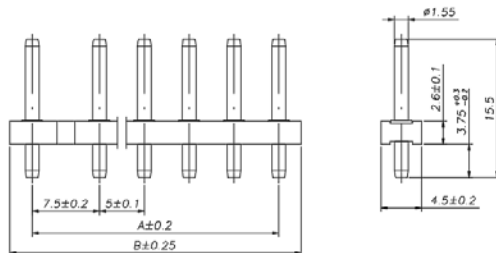

### Housing

型号Type	尺寸(mm)	
	A	B
XD-C2-2Y-X-05	-----	12.80
XD-C2-3Y-X-05	5.00	17.80
XD-C2-4Y-X-05	10.00	22.80
XD-C2-5Y-X-05	15.00	27.80
XD-C2-6Y-X-05	20.00	32.80

### Wafer

型号Type	尺寸(mm)	
	A	B
XD-C2-2A-X-05	7.50	12.50
XD-C2-3A-X-05	12.50	17.50
XD-C2-4A-X-05	17.50	22.50
XD-C2-5A-X-05	22.50	27.50
XD-C2-6A-X-05	27.50	32.50

## 5.08mm 系列

12

• 间距 PITCH: 5.08mm (71~76页)

5.08单排条形连接器 XD-5.08 系列

5.08单排条形连接器 XD-C5080 系列

5.08单排条形连接器 XD-5083 系列

5.08双排条形连接器 XD-5084 系列

# 主要技术特征 MAIN SPECIFICATIONS

间距 Pitch: 5.08mm

线数 Poles: 2~20

适用线规 APPLICable Wire: AWG#18- #24

适用基板厚度 APPLICable PC board thickness: 1.6mm

温度范围 Temperatuer Range: -25°C~ +85°C

额定电压 Voltage Rating: 250V AC, DC

额定电流 Current Rating: 7A AC, DC

接触电阻 Contract Resistance: 20mΩ Max

绝缘电阻 Insulation Resistance: 1000mΩ Min

耐压 Withstanding Voltang: 1500V

# XD-5.08系列

● Terminal

XD-5.08-T

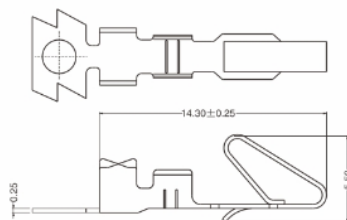

● Housing

XD-5.08-Y

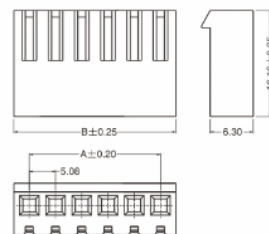

● Wafer

XD-5.08-NA

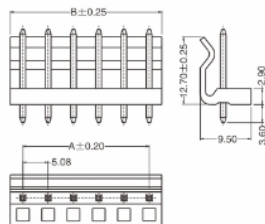

● Wafer

XD-5.08-NAW

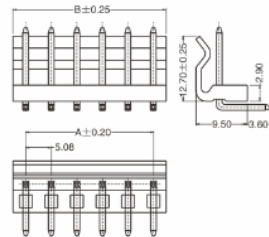

● Wafer

XD-5.08-NAW-G

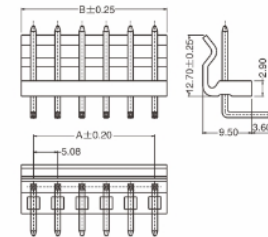

# 材料 MATERIAL

端子 Terminal: Phosphor bronz

孔座 Housing: Nylon66 UL94V-0

针座 Wafer: Nylon66 UL94V-0



● Housing

型号Type	尺寸 (mm)	
	A	B
XD-5.08-2Y	5.08	9.60
XD-5.08-3Y	10.16	14.68
XD-5.08-4Y	15.24	19.76
XD-5.08-5Y	20.32	24.84
XD-5.08-6Y	25.40	29.92
XD-5.08-7Y	30.48	35.00
XD-5.08-8Y	35.56	40.08
XD-5.08-20Y	96.52	101.04

● Wafer

型号Type	尺寸 (mm)	
	A	B
XD-5.08-2A/AW/AW-G	5.08	10.16
XD-5.08-3A/AW/AW-G	10.16	15.24
XD-5.08-4A/AW/AW-G	15.24	20.32
XD-5.08-5A/AW/AW-G	20.32	25.40
XD-5.08-6A/AW/AW-G	25.40	30.48
XD-5.08-7A/AW/AW-G	30.48	35.56
XD-5.08-8A/AW/AW-G	35.56	40.64
XD-5.08-20A/AW/AW-G	96.52	101.6

# 主要技术特征 MAIN SPECIFICATIONS

间距 Pitch: 5.08mm

线数 Poles: 2~8

适用线规 APPLICable Wire: AWG#18- #24

适用基板厚度 APPLICable PC board thickness: 1.6mm

温度范围 Temperatuer Range: -25°C~ +85°C

额定电压 Voltage Rating: 250V AC, DC

额定电流 Current Rating: 10A AC, DC

接触电阻 Contract Resistance: 20mΩ Max

绝缘电阻 Insulation Resistance: 1000mΩ Min

耐压 Withstanding Voltang: 1500V

# 材料 MATERIAL

端子 Terminal: Phosphor bronz

孔座 Housing: Nylon66 UL94V-0

针座 Wafer: Nylon66 UL94V-0



# XD-C5080系列 (1)

● Terminal XD-C5080-T (母端)

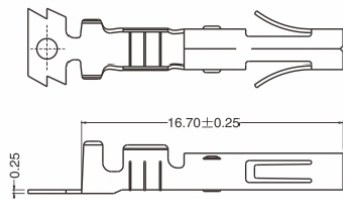

● Terminal XD-C5080-PT (公端)

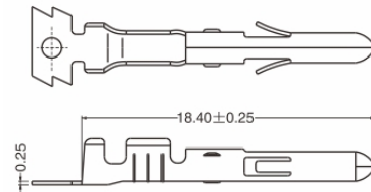

● Housing XD-C5080-NY (公)

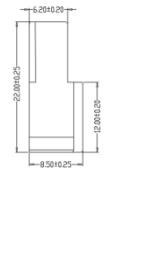
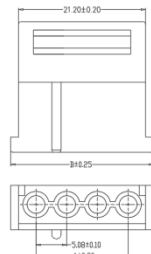

● Housing XD-C5080-NEY (母)

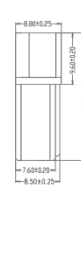
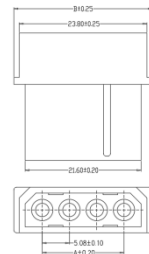

● Housing XD-C5080-NDY (公)

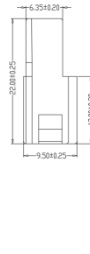
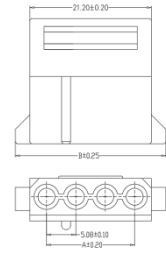

● Wafer XD-C5080-NA (实心带点)

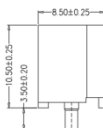
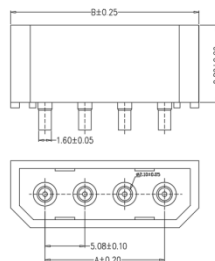

● Wafer XD-C5080-NAR (空心带齿)

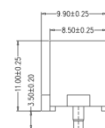
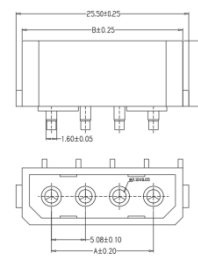

# 主要技术特征 MAIN SPECIFICATIONS

间距 Pitch: 5.08mm

线数 Poles: 2~8

适用线规 APPLICable Wire: AWG#18- #24

适用基板厚度 APPLICable PC board thickness: 1.6mm

温度范围 Temperatuer Range: -25°C~ +85°C

额定电压 Voltage Rating: 250V AC, DC

额定电流 Current Rating: 10A AC, DC

接触电阻 Contract Resistance: 20mΩ Max

绝缘电阻 Insulation Resistance: 1000mΩ Min

耐压 Withstanding Voltang: 1500V

# 材料 MATERIAL

端子 Terminal: Phosphor bronz

孔座 Housing: Nylon66 UL94V-0

针座 Wafer: Nylon66 UL94V-0



# XD-C5080系列 (2)

## ● Wafer XD-C5080-NAS (空心带边)

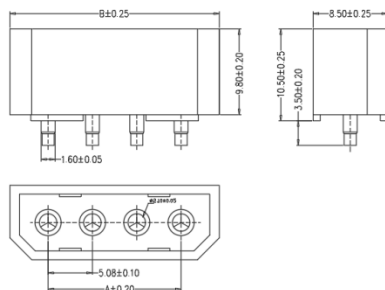

## ● Wafer XD-C5080-NAW

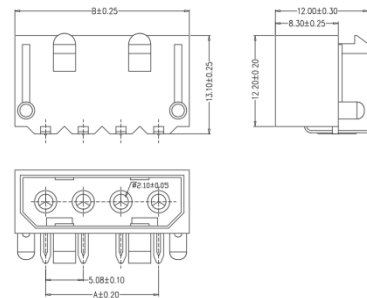

## ● Wafer XD-C5080-2xNA (空心)

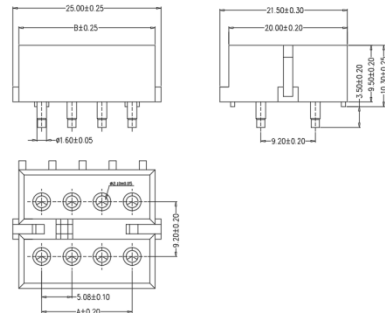

## ● Housing XD-C5080-2xNY

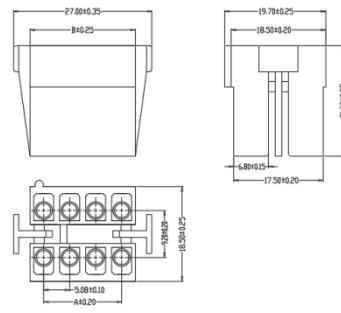

## ● Housina

型号Type	尺寸(mm)		
	A	B	
XD-C5080-2Y/EY/DY	5.08	13.44/13.12/16.04	
XD-C5080-3Y/EY/DY	10.16	18.52/20.20/21.12	
XD-C5080-4Y/EY/DY	15.24	23.60/23.28/26.20	

型号Type	尺寸(mm)	
	A	B
XD-05C80-2x2Y	5.08	10.44
XD-05C80-2x3Y	10.16	15.62
XD-05C80-2x4Y	15.24	20.60

## ● Wafer

型号Type	尺寸(mm)	
	A	B
XD-C5080-2A/AR/AS/AI	5.08	13.34
XD-C5080-3A/AR/AS/AI	10.16	18.42
XD-C5080-4A/AR/AS/AI	15.24	23.50

型号Type	尺寸mm	
	A	B
XD-C5080-22A	5.08	12.84
XD-C5080-2m3A	10.16	17.92
XD-C5080-2x4A	15.24	23.00

# 主要技术特征 MAIN SPECIFICATIONS

间距 Pitch: 5.08mm

线数 Poles: 2~12

适用线规 APPLICable Wire: AWG#16- #22

适用基板厚度 APPLICable PC board thickness: 1.6mm

温度范围 Temperatuer Range: -25°C~ +85°C

额定电压 Voltage Rating: 600V AC, DC

额定电流 Current Rating: 15A AC, DC

接触电阻 Contract Resistance: 10mΩ Max

绝缘电阻 Insulation Resistance: 1000mΩ Min

耐压 Withstanding Voltang: 2200V

# 材料 MATERIAL

端子 Terminal: Phosphor bronz

孔座 Housing: PBT UL94V-0

针座 Wafer: PBT UL94V-0



# XD-5083系列

## Terminal XD-5083-T-05

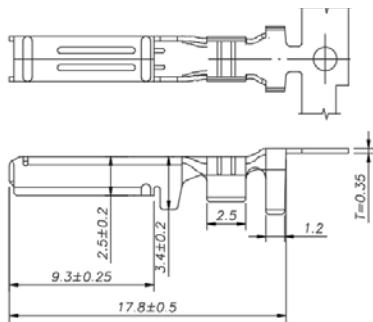

## Housing XD-5083-NY-05

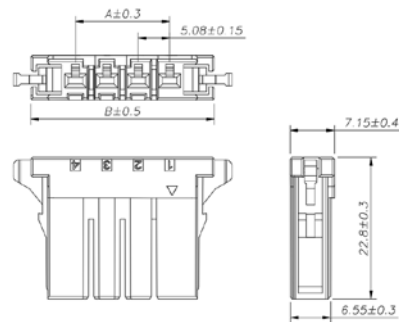

## Wafer XD-5083-NA-05

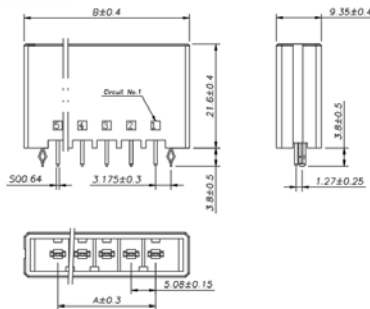

## Wafer XD-5083-NAW-05

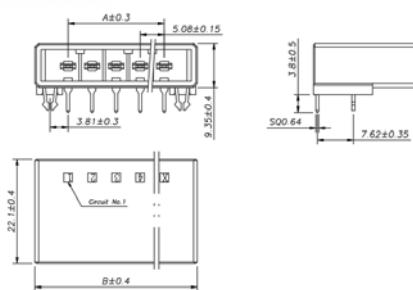

## Housing

型号Type	尺寸(mm)	
	A	B
XD-5083-2Y-X-05	5.08	19.02
XD-5083-3Y-X-05	10.16	24.10
XD-5083-4Y-X-05	15.24	29.18
XD-5083-12Y-X-05	55.88	69.82

## Wafer

型号Type	尺寸(mm)	
	A	B
XD-5083-2A/2AW-X-05	5.08	19.02
XD-5083-2A/2AW-X-05	10.16	24.10
XD-5083-2A/2AW-X-05	15.24	29.18
XD-5083-2A/2AW-X-05	55.88	69.82

# 主要技术特征 MAIN SPECIFICATIONS

间距 Pitch: 5.08mm

线数 Poles: 2~12

适用线规 APPLICable Wire: AWG#16- #22

适用基板厚度 APPLICable PC board thickness: 1.6mm

温度范围 Temperatuer Range: -25°C~ +85°C

额定电压 Voltage Rating: 600V AC, DC

额定电流 Current Rating: 15A AC, DC

接触电阻 Contract Resistance: 10mΩ Max

绝缘电阻 Insulation Resistance: 1000mΩ Min

耐压 Withstanding Voltang: 2200V

# XD-5084系列

● Terminal XD-5084-T-05

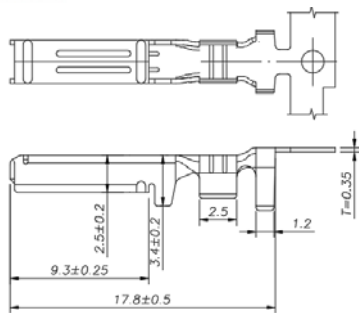

● Terminal XD-5084-PT-05

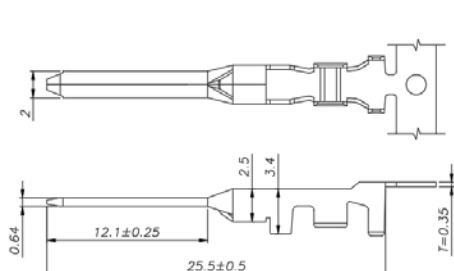

● Housing XD-5084-2xNY-05

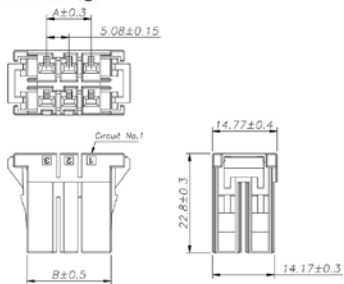

● Housing XD-5084-2xNSY-05

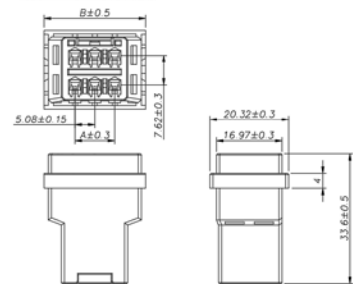

● Housing XD-5084-2xNEY-05

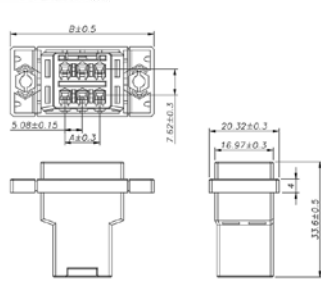

● Housing

型号Type	尺寸 (mm)	
	A	B
XD-5084-2x2Y-X-05	5.08	14.16
XD-5084-2x3Y-X-05	10.16	19.24
XD-5084-2x4Y-X-05	15.24	24.32
XD-5084-2x12Y-X-05	55.88	64.96

型号Type	尺寸 (mm)	
	A	B
XD-5084-2x2SY-X-05	5.08	21.84
XD-5084-2x3SY-X-05	10.16	26.92
XD-5084-2x4SY-X-05	15.24	32.00
XD-5084-2x12SY-X-05	55.88	72.64

型号Type	尺寸 (mm)	
	A	B
XD-5084-2x2EY-X-05	5.08	36.83
XD-5084-2x3EY-X-05	10.16	41.91
XD-5084-2x4EY-X-05	15.24	46.99
XD-5084-2x12EY-X-05	55.88	87.63

# 材料 MATERIAL

端子 Terminal: Phosphor bronz

孔座 Housing: PBT UL94V-0

针座 Wafer: PBT UL94V-0





## 6.20mm 系列

- 13 • 间距 PITCH: 6.20mm (77~79页)  
6.20单、双排条形连接器 XD-C6200 系列

# 主要技术特征 MAIN SPECIFICATIONS

间距 Pitch: 6.20mm

线数 Poles: 2~6

适用线规 APPLICABLE WIRE: AWG#12- #20

温度范围 Temperaturer Range: -25°C~ +85°C

额定电压 Voltage Rating: 600V AC, DC

额定电流 Current Rating: 20A AC, DC

接触电阻 Contact Resistance: 20mΩ Max

绝缘电阻 Insulation Resistance: 1000mΩ Min

耐压 Withstanding Voltang: 2000V

# XD-C6200系列 (1)

● Terminal XD-C6200-T-05

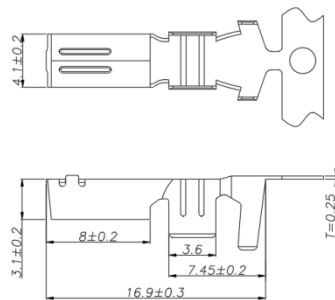

● Terminal XD-C6200-PT-05

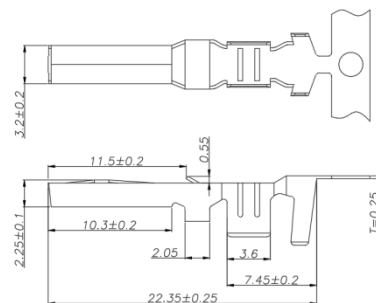

● Housing XD-C6200-NY-05

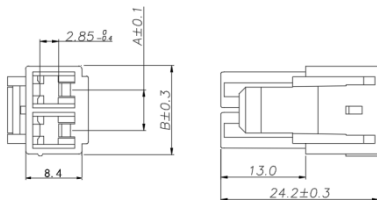

● Housing XD-C6200-NEY-05

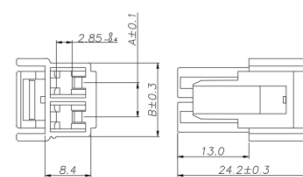

● Housing XD-C6200-NSY-05

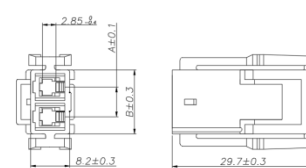

● Housing XD-C6200-2xNY-05

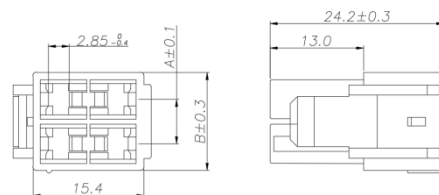

● Housing XD-C6200-2xNEY-05

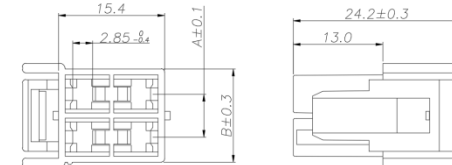

# 材料 MATERIAL

端子 Terminal: Phosphor bronz

孔座 Housing: Nylon66 UL94V-0



## 主要技术特征 MAIN SPECIFICATIONS

间距 Pitch: 6.20mm

线数 Poles: 2~6

适用线规 APPLICABLE WIRE: AWG#12- #20

温度范围 Temperature Range: -25°C~ +85°C

额定电压 Voltage Rating: 600V AC, DC

额定电流 Current Rating: 20A AC, DC

接触电阻 Contact Resistance: 20mΩ Max

绝缘电阻 Insulation Resistance: 1000mΩ Min

耐压 Withstanding Voltage: 2000V

## 材料 MATERIAL

端子 Terminal: Phosphor bronze

孔座 Housing: Nylon66 UL94V-0



## XD-C6200系列 (2)

- Housing XD-C6200-2xNSY-05

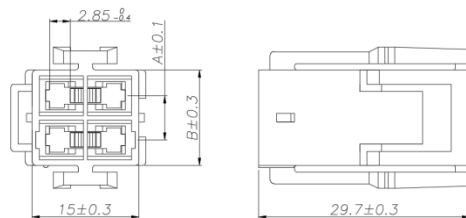

- Housing XD-C6200-1S-05

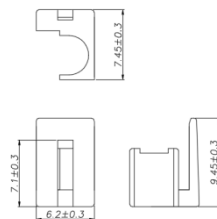

- Housing XD-C6200-NS-05

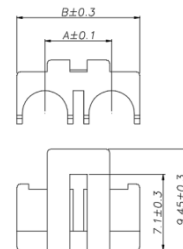

- Housing

- Housing

- Housing

型号Type	尺寸(mm)	
	A	B
XD-C6200-2Y/EY/SY-05	6.20	13.40
XD-C6200-3Y/EY/SY-05	12.40	19.60
XD-C6200-4Y/EY/SY-05	18.60	25.80

型号Type	尺寸(mm)	
	A	B
XD-C6200-2x2EY-05	6.20	13.40
XD-C6200-2x3EY-05	12.40	19.60
XD-C6200-2x4EY-05	18.60	25.80

型号Type	尺寸(mm)	
	A	B
XD-C6200-2S-05	6.20	11.40
XD-C6200-3S-05	12.40	17.60
XD-C6200-4S-05	18.60	23.80

## 6.35mm 系列

14

• 间距 PITCH: 6.35mm (80~82页)

6.35单排条形连接器 XD-C6350 系列

## 主要技术特征 MAIN SPECIFICATIONS

间距 Pitch: 6.35mm

线数 Poles: 2~8

适用线规 APPLICable Wire: AWG#14- #24

适用基板厚度 APPLICable PC board thickness: 1.6mm

温度范围 Temperatuer Range: -25°C~ +85°C

额定电压 Voltage Rating: 600V AC, DC

额定电流 Current Rating: 15A AC, DC

接触电阻 Contract Resistance: 20mΩ Max

绝缘电阻 Insulation Resistance: 1000mΩ Min

耐压 Withstanding Voltang: 1500V

## 材料 MATERIAL

端子 Terminal: Phosphor bronz

孔座 Housing: Nylon66 UL94V-0

针座 Wafer: Nylon66 UL94V-0



## XD-C6350系列 (1)

● Terminal XD-C6350-T

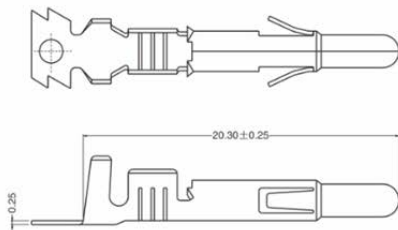

● Terminal XD-C6350-PT

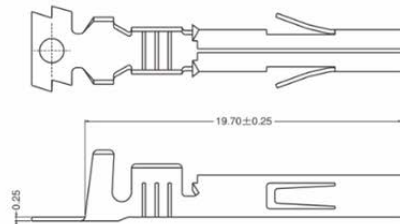

● Housing XD-C6350-NY

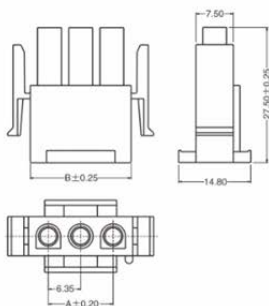

● Housing XD-C6350-3xNY

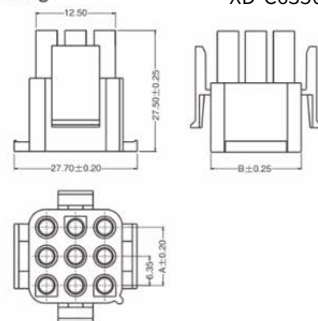

# 主要技术特征 MAIN SPECIFICATIONS

间距 Pitch: 6.35mm

线数 Poles: 2~8

适用线规 APplicable Wire: AWG#14- #24

适用基板厚度 APplicable PC board thickness: 1.6mm

温度范围 Temperatuer Range: -25°C~ +85°C

额定电压 Voltage Rating: 600V AC, DC

额定电流 Current Rating: 15A AC, DC

接触电阻 Contract Resistance: 20mΩ Max

绝缘电阻 Insulation Resistance: 1000mΩ Min

耐压 Withstanding Voltang: 1500V

# 材料 MATERIAL

端子 Terminal: Phosphor bronz

孔座 Housing: Nylon66 UL94V-0

针座 Wafer: Nylon66 UL94V-0



# XD-C6350系列 (2)

## ● Housing

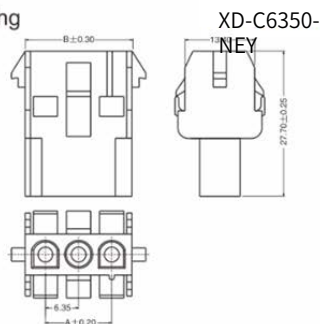

## ● Housing

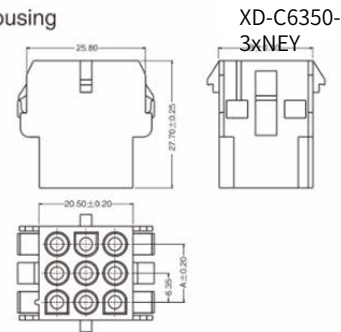

## ● Wafer

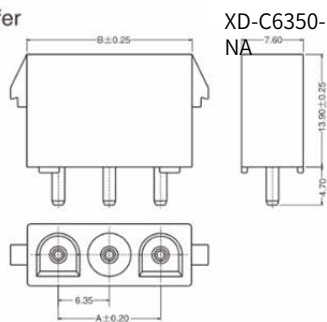

## ● Wafer

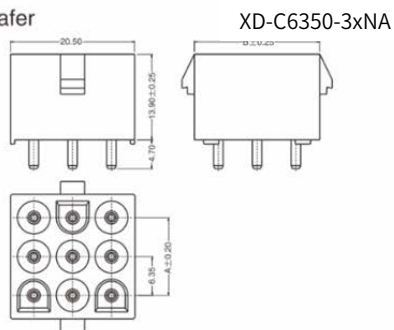

## ● Housing

型号Type	尺寸 (mm)	
	A	B
XD-C6350-2V/EY	8.35	14.20
XD-C6350-3V/EY	12.70	20.55
XD-C6350-4V/EY	19.05	26.90
XD-C6350-5V/EY	25.40	33.25
XD-C6350-6V/EY	31.75	39.60
XD-C6350-7V/EY	38.10	45.95
XD-C6350-8V/EY	44.45	52.30

型号Type	尺寸 (mm)	
	A	B
XD-C6350-3x2V/EY	8.35	14.20
XD-C6350-3x3V/EY	12.70	20.55
XD-C6350-3x4V/EY	19.05	26.90
XD-C6350-3x5V/EY	25.40	33.25

## ● Wafer

型号Type	尺寸 (mm)	
	A	B
XD-C6350-2A	6.35	14.20
XD-C6350-3A	12.70	20.55
XD-C6350-4A	19.05	26.90
XD-C6350-5A	25.40	33.25
XD-C6350-6A	31.75	39.60
XD-C6350-7A	38.10	45.95
XD-C6350-8A	44.45	52.30

型号Type	尺寸 (mm)	
	A	B
XD-C6350-3x2A	6.35	14.20
XD-C6350-3x3A	12.70	20.55
XD-C6350-3x4A	19.05	26.90
XD-C6350-3x5A	25.40	33.25

## 8.00mm 系列

15

• 间距 PITCH: 8.00mm (83~84页)

8.00单排条形连接器 XD-8001 系列

## 主要技术特征 MAIN SPECIFICATIONS

间距 Pitch: 8.00mm

线数 Poles: 1~3

适用线规 APPLICable Wire: AWG#18- #24

温度范围 Temperatuer Range: -25°C~ +85°C

额定电压 Voltage Rating: 250V AC, DC

额定电流 Current Rating: 7A AC, DC

接触电阻 Contract Resistance: 20mΩ Max

绝缘电阻 Insulation Resistance: 1000mΩ Min

耐压 Withstanding Voltang: 1000V

## 材料 MATERIAL

端子 Terminal: Phosphor bronz

孔座 Housing: Nylon66 UL94V-0

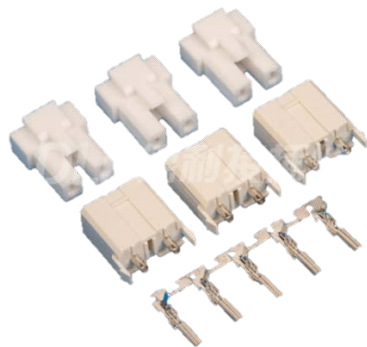

## XD-8001系列

### Terminal XD-8001-T-05

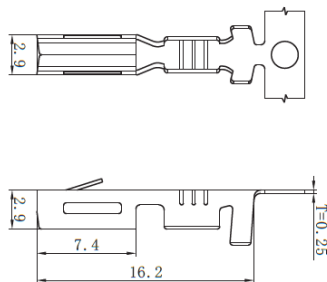

### Housing XD-8001-NY-05

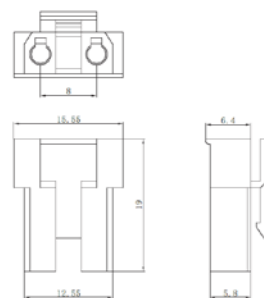

### Wafer XD-8001-NA-05

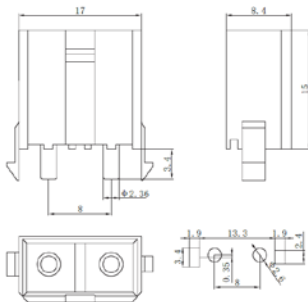



## 10.16mm 系列

16

• 间距 PITCH: 10.16mm (85~88页)

10.16单排条形连接器 XD-10.16 系列

10.16双排条形连接器 XD-10.16 系列

## 主要技术特征 MAIN SPECIFICATIONS

间距 Pitch: 10.16mm

线数 Poles: 1~3

适用线规 APplicable Wire: AWG#18- #24

温度范围 Temperatuer Range: -25°C~ +85°C

额定电压 Voltage Rating: 250V AC, DC

额定电流 Current Rating: 7A AC, DC

接触电阻 Contract Resistance: 20mΩ Max

绝缘电阻 Insulation Resistance: 1000mΩ Min

耐压 Withstanding Voltang: 1000V

## 材料 MATERIAL

端子 Terminal: Phosphor bronz

孔座 Housing: Nylon66 UL94V-0

针座 Wafer: PBT UL94V-0



## XD-10.16 单排 系列 (1)

### Terminal XD-10.16-T-05

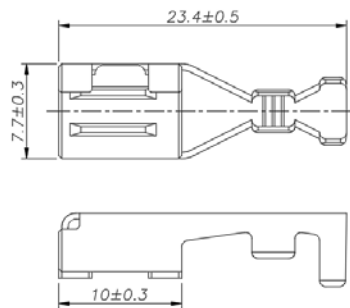

### Terminal XD-10.16-PT-05

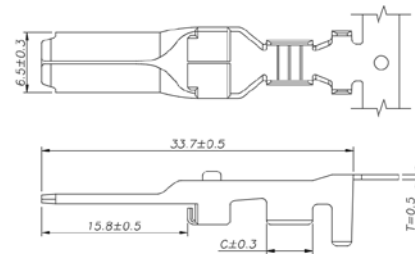

### Housing XD-10.16-NY-05

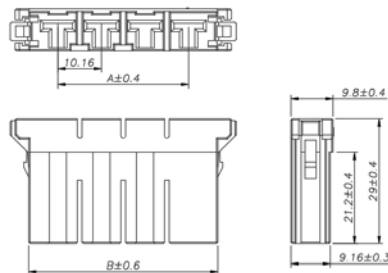

### Housing XD-10.16-NEY-05

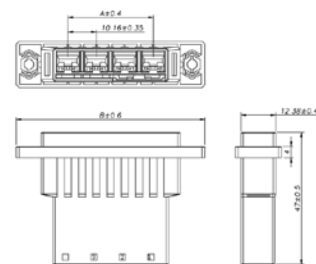

## 主要技术特征 MAIN SPECIFICATIONS

间距 Pitch: 10.16mm

线数 Poles: 1~3

适用线规 APplicable Wire: AWG#18- #24

温度范围 Temperatuer Range: -25°C~ +85°C

额定电压 Voltage Rating: 250V AC, DC

额定电流 Current Rating: 7A AC, DC

接触电阻 Contract Resistance: 20mΩ Max

绝缘电阻 Insulation Resistance: 1000mΩ Min

耐压 Withstanding Voltang: 1000V

## 材料 MATERIAL

端子 Terminal: Phosphor bronz

孔座 Housing: Nylon66 UL94V-0

针座 Wafer: PBT UL94V-0

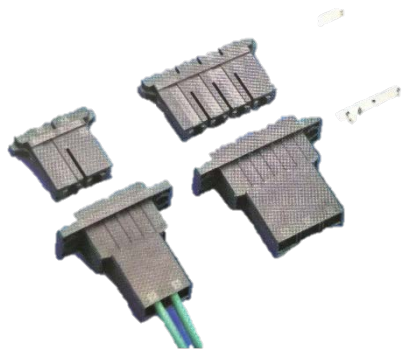

## XD-10.16 单排 系列 (2)

### ● Wafer XD-10.16-NA-05

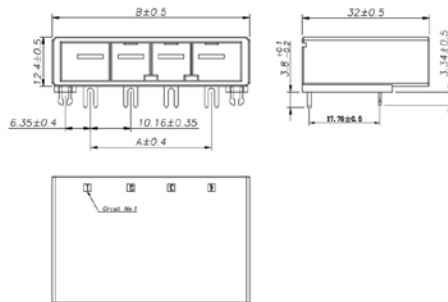

### ● Wafer XD-10.16-NAW-05

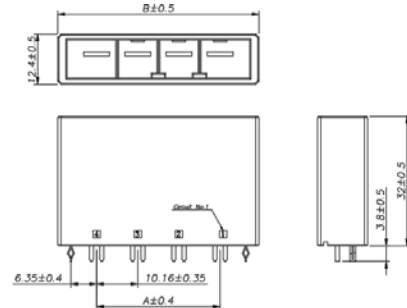

### ● Housing

型号Type	尺寸(mm)	
	A	B
XD-10.16-2Y/EY-X-05	10.16	23.76 / 47.00
XD-10.16-3Y/EY-X-05	20.32	33.92 / 57.16
XD-10.16-4Y/EY-X-05	30.48	44.08 / 67.32
XD-10.16-5Y/EY-X-05	40.64	54.24 / 77.48
XD-10.16-6Y/EY-X-05	50.80	64.40 / 87.64

### ● Wafer

型号Type	尺寸(mm)	
	A	B
XD-10.16-2A/AW-05	10.16	29.36
XD-10.16-3A/AW-05	20.32	39.52
XD-10.16-4A/AW-05	30.48	49.68
XD-10.16-5A/AW-05	40.64	59.84
XD-10.16-6A/AW-05	50.80	70.00

## 主要技术特征 MAIN SPECIFICATIONS

间距 Pitch: 10.16mm

线数 Poles: 1~3

适用线规 APPLICABLE WIRE: AWG#18- #24

温度范围 Temperatuer Range: -25°C~ +85°C

额定电压 Voltage Rating: 250V AC, DC

额定电流 Current Rating: 7A AC, DC

接触电阻 Contact Resistance: 20mΩ Max

绝缘电阻 Insulation Resistance: 1000mΩ Min

耐压 Withstanding Voltang: 1000V

## 材料 MATERIAL

端子 Terminal: Phosphor bronz

孔座 Housing: Nylon66 UL94V-0

针座 Wafer: PBT UL94V-0

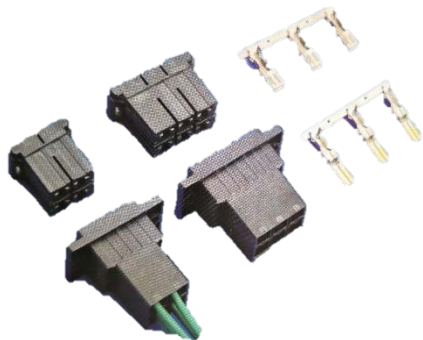

## XD-10.16 双排 系列

### Terminal XD-10.16-T-05

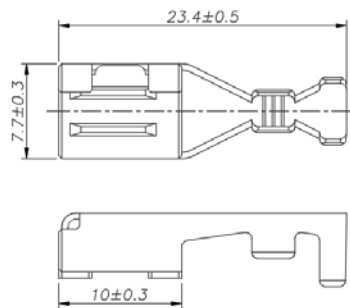

### Housing XD-10.16-2xNY-05

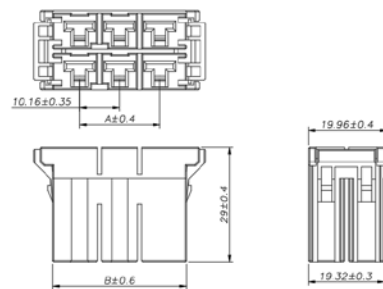

### Wafer XD-10.16-2xNA-05

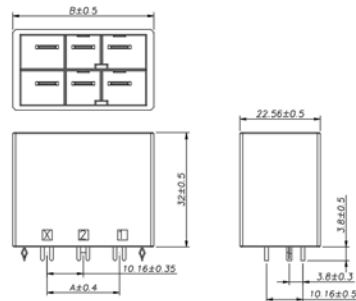

### Wafer XD-10.16-2xNAW-05

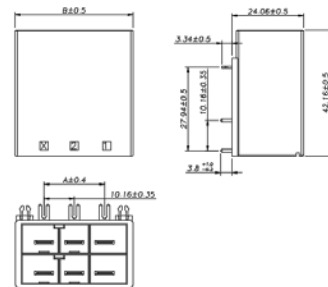

### Housing

型号Type	尺寸(mm)	
	A	B
XD-10.16-2x2Y-X-05	10.16	23.76
XD-10.16-2x3Y-X-05	20.32	33.92
XD-10.16-2x4Y-X-05	30.48	44.08
XD-10.16-2x5Y-X-05	40.64	54.24
XD-10.16-2x6Y-X-05	50.80	64.40

### Wafer

型号Type	尺寸(mm)	
	A	B
XD-10.16-2x2A/AW-05	10.16	29.36
XD-10.16-2x3A/AW-05	20.32	39.52
XD-10.16-2x4A/AW-05	30.48	49.68
XD-10.16-2x5A/AW-05	40.64	59.84
XD-10.16-2x6A/AW-05	50.80	70.00

## X-ON Electronics

Largest Supplier of Electrical and Electronic Components

*Click to view similar products for [Headers & Wire Housings](#) category:*

*Click to view products by [chxunda](#) manufacturer:*

Other Similar products are found below :

[0015917161](#) [0022155065](#) [57102-F02-18ULF](#) [58102-G61-06LF](#) [582553-1](#) [01.001.5753.1](#) [0050291907](#) [02.125.8002.8](#) [609-3404](#) [61062-3](#)  
[CSU011177004](#) [622-0430](#) [622-3653LF](#) [63453-116](#) [636-1030](#) [636-1427](#) [636-3427](#) [636-4007](#) [641938-9](#) [65495-038](#) [65692-001LF](#) [65781-018](#)  
[65781-047](#) [65817-010LF](#) [65817-015LF](#) [67095-007LF](#) [67601157](#) [68631-112](#) [68645-018](#) [699319-000](#) [70.362.1628.0](#) [70-4210](#) [70-4226B](#) [70-](#)  
[4853B](#) [71.350.2428.0](#) [733-134](#) [733-162](#) [760-3052](#) [MHR-64-VUAL](#) [80.063.4001.1](#) [800-90-001-10-001000](#) [801-43-002-10-013000](#)  
[801-43-006-10-002000](#) [803-43-024-10-001000](#) [803-93-012-10-001000](#) [8-1437020-4](#) [819-22-004-30-001101](#) [820-22-006-30-001101](#)  
[820-22-008-30-001101](#) [821-22-002-10-001101](#)