

FEATURES

- For use in cable-to-cable and cable-to-panel applications.
- Designed for medium duty.
- Plug prongs are .250" (6.35mm) wide and .055" (1.40mm) thick.
- Socket contacts have solder eyelet contacts of .093" diameters.
- Polarized to prevent wrong-way insertion.
- Plugs have projecting flat blades, sockets have recessed twin bellows.
- Cable clamps of zinc and clear irridite-plated steel are used for strain relief.
- Bifurcated bellows socket contact provides four individual flexing surfaces for maximum contact with the blade.
- Plugs and sockets have recessed pockets with barriers around the contacts.
- A shoulder extends around the face (mating) side of both plug and socket presenting a finished appearance when mounted in bracket or cap.
- Intermates with existing 400 Series Products on the market.
- UL Recognized - file - E17021B (UL1977) E130965 (1863).
- CSA - LR31996-2.
- Panel cutout dimensions (See page 2-57).

MATERIALS

Insulation Material: Molded monoblock, general purpose phenolic, black

Contact Material: Plug: Brass
Socket: Phosphor bronze

Contact Plating: Cadmium

Operating Temperature: Up to +105°C

Hood Material: Formed metal with dielectric liner in hood to prevent shorting

ELECTRICAL

Operating Voltage: 250 VAC RMS
Current Rating: 15 Amps
Current Resistance: 1.0 Milliohms maximum

POLARIZING PATTERNS FOR SERIES 2400



2402



2404



2406



2408



2410



2412

2400 Series Less Angle Bracket

| No. of Contacts | Catalog No. Plug | Catalog No. Socket |
|-----------------|------------------|--------------------|
| 2 | N/A | S-2402-LAB |
| 4 | P-2404-LAB | S-2404-LAB |
| 6 | P-2406-LAB | S-2406-LAB |
| 8 | P-2408-LAB | S-2408-LAB |
| 10 | P-2410-LAB | S-2410-LAB |
| 12 | P-2412-LAB | S-2412-LAB |

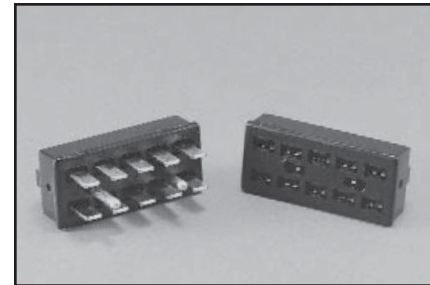

Plug

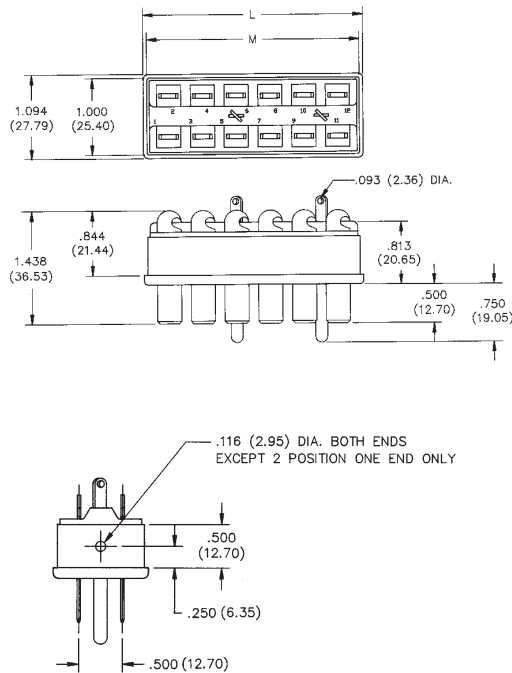

Socket

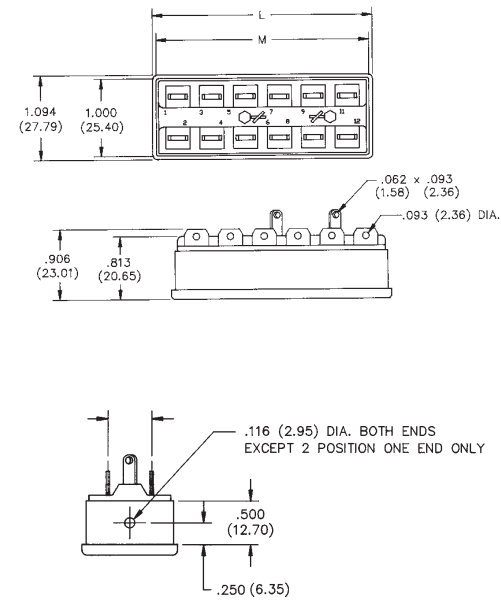

Dimensions - Plug or Socket

| No. of Contacts | M | | L | |
|-----------------|-------|-------|-------|-------|
| | in | mm | in | mm |
| 2 | .563 | 14.29 | .656 | 16.67 |
| 4 | 1.000 | 25.40 | 1.094 | 27.78 |
| 6 | 1.438 | 36.51 | 1.531 | 38.89 |
| 8 | 1.875 | 47.63 | 1.969 | 50.01 |
| 10 | 2.313 | 58.74 | 2.406 | 61.12 |
| 12 | 2.750 | 69.85 | 1.844 | 46.83 |

Marketed exclusively through distribution.

**Jones
Plugs/Sockets
Series 2400**

Multiple Density
Solder Eyelet
With Angle Bracket



2400 Series with Angle Bracket

| No. of Contacts | Catalog No. Plug | Catalog No. Socket |
|-----------------|------------------|--------------------|
| 2 | N/A | S-2402-AB |
| 4 | P-2404-AB | S-2404-AB |
| 6 | P-2406-AB | S-2406-AB |
| 8 | P-2408-AB | S-2408-AB |
| 10 | P-2410-AB | S-2410-AB |
| 12 | P-2412-AB | S-2412-AB |



Plug



Socket



Dimensions - Plug or Socket

| No. of Contacts | M | | L | |
|-----------------|-------|-------|-------|-------|
| | in | mm | in | mm |
| 2 | .563 | 14.29 | .656 | 16.67 |
| 4 | 1.000 | 25.40 | 1.094 | 27.78 |
| 6 | 1.438 | 36.51 | 1.531 | 38.89 |
| 8 | 1.875 | 47.63 | 1.969 | 50.01 |
| 10 | 2.313 | 58.74 | 2.406 | 61.12 |
| 12 | 2.750 | 69.85 | 2.844 | 72.24 |

Panel Cutout dimensions are on page 2-61.

Marketed exclusively through distribution.

2400 Series with Shallow Bracket

| No. of Contacts | Catalog No. Plug | Catalog No. Socket |
|-----------------|------------------|--------------------|
| 2 | N/A | S-2402-SB |
| 4 | P-2404-SB | S-2404-SB |
| 6 | P-2406-SB | S-2406-SB |
| 8 | P-2408-SB | S-2408-SB |
| 10 | P-2410-SB | S-2410-SB |
| 12 | P-2412-SB | S-2412-SB |



2

Plug



Socket

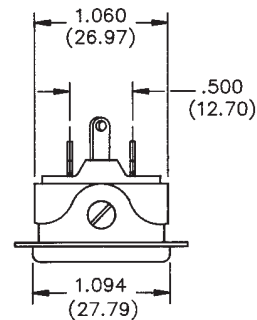
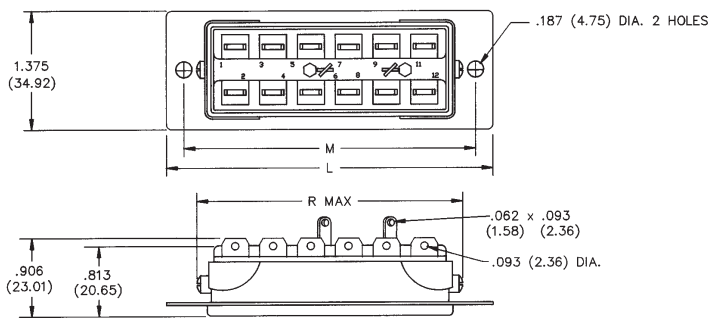

Dimensions - Plug or Socket

| No. of Contacts | L | | M | | R. Max. | |
|-----------------|-------|-------|-------|-------|---------|-------|
| | in | mm | in | mm | in | mm |
| 2 | 1.500 | 38.10 | 1.062 | 26.99 | 1.766 | 19.45 |
| 4 | 1.937 | 49.21 | 1.500 | 38.10 | 1.234 | 31.34 |
| 6 | 2.375 | 60.33 | 1.938 | 49.23 | 1.672 | 42.47 |
| 8 | 2.813 | 71.45 | 2.375 | 60.33 | 2.109 | 53.57 |
| 10 | 3.250 | 82.55 | 2.813 | 71.45 | 2.547 | 64.69 |
| 12 | 3.688 | 93.68 | 3.250 | 82.55 | 2.984 | 75.80 |

Panel Cutout dimensions are on page 2-61.

Marketed exclusively through distribution.

2400 Series with Deep Bracket

| No. of Contacts | Catalog No. Plug | Catalog No. Socket |
|-----------------|------------------|--------------------|
| 2 | N/A | S-2402-DB |
| 4 | P-2404-DB | S-2404-DB |
| 6 | P-2406-DB | S-2406-DB |
| 8 | P-2408-DB | S-2408-DB |
| 10 | P-2410-DB | S-2410-DB |
| 12 | P-2412-DB | S-2412-DB |



Plug

Socket

Plug or Socket



Dimensions - Plug or Socket

| No. of Contacts | B | | L | | M | |
|-----------------|-------|-------|-------|--------|-------|-------|
| | in | mm | in | mm | in | mm |
| 2 | .922 | 23.42 | 1.750 | 44.45 | 1.313 | 33.35 |
| 4 | 1.359 | 34.53 | 2.188 | 55.58 | 1.750 | 44.45 |
| 6 | 1.797 | 45.64 | 2.625 | 57.53 | 2.188 | 55.58 |
| 8 | 2.234 | 56.74 | 3.063 | 77.79 | 2.625 | 66.68 |
| 10 | 2.672 | 67.87 | 3.500 | 88.90 | 3.063 | 77.80 |
| 12 | 3.109 | 78.97 | 3.938 | 100.03 | 3.500 | 88.90 |

Panel Cutout dimensions are on page 2-61.

Marketed exclusively through distribution.

2400 Series with Hood and 90° Clamp

| No. of Contacts | Catalog No. Plug | Catalog No. Socket |
|-----------------|------------------|--------------------|
| 2 | N/A | S-2402-CCE |
| 4 | P-2404-CCE | S-2404-CCE |
| 6 | P-2406-CCE | S-2406-CCE |
| 8 | P-2408-CCE | S-2408-CCE |
| 10 | P-2410-CCE | S-2410-CCE |
| 12 | P-2412-CCE | S-2412-CCE |

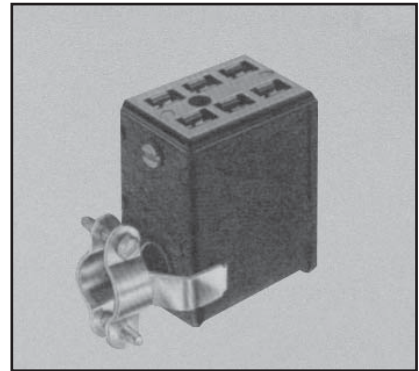
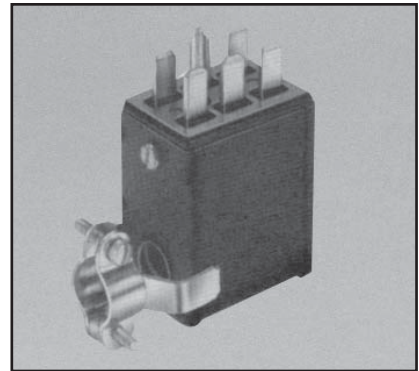

Plug



Socket



Dimensions - Plug or Socket

| No. of Contacts | L | | C | | Cable Opening | |
|-----------------|-------|-------|-------|-------|---------------|-------|
| | in | mm | in | mm | in | mm |
| 2 | .625 | 15.88 | 1.375 | 34.93 | .375 | 9.53 |
| 4 | 1.062 | 26.99 | 1.375 | 34.93 | .438 | 11.11 |
| 6 | 1.500 | 38.10 | 1.375 | 34.93 | .438 | 11.11 |
| 8 | 1.937 | 49.21 | 1.344 | 34.13 | .563 | 14.29 |
| 10 | 2.375 | 60.33 | 1.344 | 34.13 | .563 | 14.29 |
| 12 | 2.813 | 71.45 | 1.312 | 33.34 | .625 | 15.88 |

Marketed exclusively through distribution.

2400 Series with Hood and 180° Clamp

| No. of Contacts | Catalog No. Plug | Catalog No. Socket |
|-----------------|------------------|--------------------|
| 2 | N/A | S-2402-CCT |
| 4 | P-2404-CCT | S-2404-CCT |
| 6 | P-2406-CCT | S-2406-CCT |
| 8 | P-2408-CCT | S-2408-CCT |
| 10 | P-2410-CCT | S-2410-CCT |
| 12 | P-2412-CCT | S-2412-CCT |



Plug



Socket



Dimensions - Plug or Socket

| No. of Contacts | L | | Cable Opening | |
|-----------------|-------|-------|---------------|-------|
| | in | mm | in | mm |
| 2 | .625 | 15.88 | .313 | 7.94 |
| 4 | 1.062 | 26.99 | .438 | 11.11 |
| 6 | 1.500 | 38.10 | .438 | 11.11 |
| 8 | 1.937 | 49.21 | .563 | 14.29 |
| 10 | 2.375 | 60.33 | .563 | 14.29 |
| 12 | 2.813 | 71.45 | .625 | 15.88 |

Marketed exclusively through distribution.

**Panel Cutout Dimensions
Angle Bracket**

| Reference | A | | B | | C | |
|-----------|-------|-------|-------|-------|-------|-------|
| | in | mm | in | mm | in | mm |
| P-2402-AB | -- | -- | -- | -- | -- | -- |
| S-2402-AB | 1.188 | 30.16 | 1.008 | 25.60 | 1.015 | 25.78 |
| P-2404-AB | -- | -- | -- | -- | -- | -- |
| S-2404-AB | 1.625 | 41.28 | 1.445 | 36.70 | 1.015 | 25.78 |
| P-2406-AB | -- | -- | -- | -- | -- | -- |
| S-2406-AB | 2.063 | 52.40 | 1.886 | 47.83 | 1.015 | 25.78 |
| P-2408-AB | -- | -- | -- | -- | -- | -- |
| S-2408-AB | 2.500 | 63.50 | 2.320 | 58.93 | 1.015 | 25.78 |
| P-2410-AB | -- | -- | -- | -- | -- | -- |
| S-2410-AB | 2.938 | 74.63 | 2.758 | 70.05 | 1.015 | 25.78 |
| P-2412-AB | -- | -- | -- | -- | -- | -- |
| S-2412-AB | 3.375 | 85.73 | 3.195 | 81.15 | 1.015 | 25.78 |



**Panel Cutout Dimensions
Shallow Bracket**

| Reference | A | | B | | C | |
|-----------|-------|-------|-------|-------|-------|-------|
| | in | mm | in | mm | in | mm |
| P-2402-SB | -- | -- | -- | -- | -- | -- |
| S-2402-SB | 1.062 | 27.00 | .813 | 20.64 | 1.156 | 29.37 |
| P-2404-SB | -- | -- | -- | -- | -- | -- |
| S-2404-SB | 1.500 | 38.10 | 1.250 | 31.75 | 1.156 | 29.37 |
| P-2406-SB | -- | -- | -- | -- | -- | -- |
| S-2406-SB | 1.938 | 49.22 | 1.688 | 42.86 | 1.156 | 29.37 |
| P-2408-SB | -- | -- | -- | -- | -- | -- |
| S-2408-SB | 2.376 | 60.34 | 2.125 | 53.98 | 1.156 | 29.37 |
| P-2410-SB | -- | -- | -- | -- | -- | -- |
| S-2410-SB | 2.812 | 71.44 | 2.563 | 65.10 | 1.156 | 29.37 |
| P-2412-SB | -- | -- | -- | -- | -- | -- |
| S-2412-SB | 3.250 | 82.56 | 3.000 | 76.20 | 1.156 | 29.37 |



**Panel Cutout Dimensions
Deep Bracket**

| Reference | A | | B | | C | |
|-----------|-------|-------|-------|-------|-------|-------|
| | in | mm | in | mm | in | mm |
| P-2402-DB | -- | -- | -- | -- | -- | -- |
| S-2402-DB | 1.312 | 33.34 | .938 | 23.81 | 1.438 | 36.51 |
| P-2404-DB | -- | -- | -- | -- | -- | -- |
| S-2404-DB | 1.750 | 44.46 | 1.375 | 34.93 | 1.438 | 36.51 |
| P-2406-DB | -- | -- | -- | -- | -- | -- |
| S-2406-DB | 2.188 | 55.56 | 1.813 | 46.04 | 1.438 | 36.51 |
| P-2408-DB | -- | -- | -- | -- | -- | -- |
| S-2408-DB | 2.624 | 66.68 | 2.250 | 57.15 | 1.438 | 36.51 |
| P-2410-DB | -- | -- | -- | -- | -- | -- |
| S-2410-DB | 3.062 | 77.80 | 2.688 | 68.28 | 1.438 | 36.51 |
| P-2412-DB | -- | -- | -- | -- | -- | -- |
| S-2412-DB | 3.500 | 88.90 | 3.125 | 79.38 | 1.438 | 36.51 |



Marketed exclusively through distribution.

X-ON Electronics

Largest Supplier of Electrical and Electronic Components

Click to view similar products for [Jones Plugs & Sockets](#) category:

Click to view products by [CINCH](#) manufacturer:

Other Similar products are found below :

[750-1103](#) [HDRA-E68LFD-7C](#) [MR-8LK2+](#) [S-2408-CCE](#) [302R](#) [30-9733](#) [30-9798](#) [38330-0203](#) [38330-1908](#) [38330-2604](#) [38330-2610](#) [38330-4015](#) [38330-5704](#) [38330-6418](#) [38331-0804](#) [38331-1406](#) [38331-1410](#) [38331-3908](#) [38331-8206](#) [38335-5104](#) [38339-0100](#) [38339-0374](#) [38540-0405](#) [38540-0613](#) [38540-1505](#) [38540-1909](#) [38540-1913](#) [38540-4209](#) [38540-6412](#) [38540-9405](#) [38541-0008](#) [38541-0009](#) [38541-1212](#) [38541-3008](#) [38541-5510](#) [38542-0806](#) [38542-1006](#) [38549-0213](#) [38549-0751](#) [312R](#) [333R](#) [38330-1512](#) [38330-1518](#) [38330-1903](#) [38330-8503](#) [38331-0808](#) [38331-1415](#) [38331-1421](#) [38331-3803](#) [38331-3806](#)