

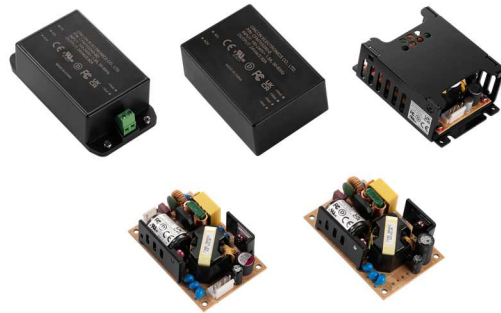

CFM70S SERIES 70 WATT OPEN FRAME AC-DC MODULES

Features

- Universal Input Range 85~264Vac
- High Efficiency up to 91%
- 2"x 3" Open Frame Compact Size
- Class I and Class II
- No Load Input Power < 0.15W
- Approval IEC/EN/UL 62368-1 Ed 3.0
- Meets IEC/EN 60335-1
- Approval EN 55032 Class B and CISPR/FCC Class B
- Operating Altitude 5000m
- Continuous Short Circuit Protection
- Over Voltage Protection
- Over Voltage Category OVC II & OVC III



MODEL NUMBER	OUTPUT VOLTAGE	OUTPUT CURRENT	VOLTAGE ACCURACY NOTE1	RIPPLE& NOISE NOTE2	LINE REGULATION NOTE3	LOAD REGULATION NOTE4	%EFF. (Typ.) NOTE5
CFM70S050	5 V	10.0 A	±2%	150 mV	±0.5%	±1%	86%
CFM70S120	12 V	5.80 A	±2%	120 mV	±0.5%	±1%	90%
CFM70S150	15 V	4.65 A	±1%	150 mV	±0.5%	±1%	90%
CFM70S240	24 V	2.92 A	±1%	240 mV	±0.5%	±1%	90%
CFM70S360	36 V	1.94 A	±1%	360 mV	±0.5%	±1%	90%
CFM70S480	48 V	1.46 A	±1%	480 mV	±0.5%	±1%	91%

Note:

1. Voltage accuracy is set at 100% full load.
2. Add a 0.1uF ceramic capacitor and a 10uF E.L. capacitor to output for ripple & noise measurement @20MHz BW.
3. Line regulation is measured from 90V_{ac} to 264V_{ac} with 100% full load.
4. Load regulation is measured from 10% to full load.
5. Typical efficiency at 230 V_{ac}.
6. Standard input and output connectors (CN1 and CN2) wafer with TAIWAN KING PIN TERMINAL PVHI series and mate with JST housing VHR series and JST SVH-41T-P1.1 series crimp terminal and output connectors wire 16AWG.

PART NUMBER

Series	Number of Outputs	Nominal Output Voltage	Type
CFM70	O	XX	-X (Option)
CFM70	S : Single	050 : 05V 120 : 12V 150 : 15V 240 : 24V 360 : 36V 480 : 48V	None : Wafer P : PCB Mount CA : Cover E : Encapsulated S : Terminal Block SD : Terminal Block with Din rail

Part Number Example:

CFM70S120: Open Frame, 70W, Single 12V_{dc} Output



CFM70S Series

TECHNICAL SPECIFICATIONS

(All specifications are typical at nominal input, full load at 25°C unless otherwise noted.)

ABSOLUTE MAXIMUM RATINGS

PARAMETER	NOTES and CONDITIONS	Device	Min.	Typ.	Max.	Units
Input Voltage	Safety approvals only to the AC input (DC input no safety)	All	85		264	V _{ac}
				120		370
Operating Temperature	See Derating Curve	All	-30		80	°C
Storage Temperature		All	-30		85	°C
Operating Altitude	IEC/EN/UL 62368-1 OVC II	All			5000	m
	IEC/EN 62368-1 OVC III				2000	
	Meets IEC/EN 60335-1 OVC II				3000	

INPUT CHARACTERISTICS

PARAMETER	NOTES and CONDITIONS	Device	Min.	Typ.	Max.	Units
Operating Voltage Range		All	100		240	V _{ac}
Input Frequency Range		All	50		60	Hz
Maximum Input Current	100% Load, V _{in} =100V _{ac}	All			1.5	A
Leakage Current		All			0.1	mA
Inrush Current	V _{in} =240V _{ac} , Cold start at 25°C	All		130		A

OUTPUT CHARACTERISTICS

PARAMETER	NOTES and CONDITIONS	Device	Min.	Typ.	Max.	Units
Output Voltage Set Point	V _{in} =Nominal V _{in} , I _o =I _o max., T _c =25°C	CFM70S050	4.90	5	5.10	V _{dc}
		CFM70S120	11.76	12	12.24	
		CFM70S150	14.85	15	15.15	
		CFM70S240	23.76	24	24.24	
		CFM70S360	35.64	36	36.36	
		CFM70S480	47.52	48	48.48	
Operating Output Current Range	V _{in} =115V _{ac} and 230V _{ac} , T _c =25°C	CFM70S050			10.0	A
		CFM70S120			5.80	
		CFM70S150			4.65	
		CFM70S240			2.92	
		CFM70S360			1.94	
		CFM70S480			1.46	
Holdup Time	V _{in} =115V _{ac}	All		10		ms
Output Voltage Regulation						
Load Regulation	10% Load to full load	All			±1.0	%
Line Regulation	V _{in} =High line to low line	All			±0.5	%
Over Voltage Protection	Hiccup mode (Auto recovery)	CFM70S050			6.3	V _{dc}
		CFM70S120			15.6	
		CFM70S150			18.0	
		CFM70S240			29.1	
		CFM70S360			43.3	
		CFM70S480			56.8	
Over Current Protection	Hiccup mode (Auto recovery)	All	110		140	%
Short Circuit Protection	Hiccup mode (Auto recovery)	All				



CFM70S Series

PARAMETER	NOTES and CONDITIONS	Device	Min.	Typ.	Max.	Units
Output Ripple and Noise	1. Add a 0.1uF ceramic capacitor and a 10uF aluminum electrolytic capacitor to output 2. Oscilloscope is 20MHz band width 3. Ambient Temperature=25°C	CFM70S050			150	mV
		CFM70S120			120	
		CFM70S150			150	
		CFM70S240			240	
		CFM70S360			360	
		CFM70S480			480	
Load Capacitance	1. $V_{in}=115V_{ac}$ and $230V_{ac}$ 2. Output is max. load 3. Ambient temperature=25°C	CFM70S050			10300	uF
		CFM70S120			6000	
		CFM70S150			4700	
		CFM70S240			2920	
		CFM70S360			1980	
		CFM70S480			930	
Efficiency	1. Input voltage is $230V_{ac}$ 2. Output is rated load	CFM70S050		86		%
		CFM70S120		90		
		CFM70S150		90		
		CFM70S240		90		
		CFM70S360		90		
		CFM70S480		91		

ISOLATION CHARACTERISTICS

PARAMETER	NOTES and CONDITIONS	Device	Min.	Typ.	Max.	Units
Input to Output	1 Minute	All			4250	V_{ac}
Isolation Resistance	Input to output	All	100			MΩ

FEATURE CHARACTERISTICS

PARAMETER	NOTES and CONDITIONS	Device	Min.	Typ.	Max.	Units
Switching Frequency	Pout=max. rated power	All		65		kHz

GENERAL SPECIFICATIONS

PARAMETER	NOTES and CONDITIONS	Device	Min.	Typ.	Max.	Units
MTBF	$I_o=100\%$; $T_a=25^\circ C$ per MIL-HDBK-217F	All	500			k hours
Humidity	Non-condensing	All			93	% RH
Shock	Meet MIL-STD-810F Table 516.5, Table 516.5-I 10ms, each axis 3 times($\pm X$ 、 $\pm Y$ 、 $\pm Z$ axis)	All		75		g
Vibration	Meet MIL-STD-810F Table 514.5C-VIII, 15~2000Hz, X、Y、Z axis, 1 hour (each axis),. Total 3 hrs.	All		4		g
Weight		CFM70S		96.1		grams
		CFM70S-P		94.1		
		CFM70S-CA		183		
		CFM70S-E		223		
		CFM70S-S		236		
		CFM70S-SD		333		
Dimensions	Open Frame (Wafer)	All	3.000x2.000x1.067 Inches (76.20x50.80x27.1 mm)			
	P (PCB Mount)		3.000x2.000x1.142 Inches (76.20x50.80x29mm)			
	CA (Cover)		3.598x2.520x1.358 Inches (91.40x64.00x34.50 mm)			
	E (Encapsulated)		2.170x3.140x1.201 Inches (55.20x79.80x30.50 mm)			
	S (Terminal Block)		2.170x4.200x1.201 Inches (55.20x106.60x30.50 mm)			
	SD (Din rail type)		2.170x4.200x1.783 Inches (55.20x106.60x45.30 mm)			



CFM70S Series

GENERAL SPECIFICATIONS

Safety	Class I, Class II, IEC/EN/UL62368-1	Ed 3.0
EMC Emission	EN 55032: 2015+AC: 2016, 47 CFR FCC Part 15 Subpart B, EN 61000-3-2: 2019, EN 61000-3-3: 2013	Class B
Conducted Disturbance	EN 55032, 47 CFR FCC Part 15	Class B
Radiated Disturbance	EN 55032, 47 CFR FCC Part 15	Class B
Harmonic Current Emissions	EN 61000-3-2:2019	
Voltage Fluctuations & Flicker	EN 61000-3-3:2013	
EMC Immunity	EN 55035:2017	
Electrostatic Discharge (ESD)	IEC 61000-4-2:2008, Air Discharge: $\pm 8\text{kV}$, Contact Discharge: $\pm 4\text{kV}$	Criterion A
Radio-Frequency, Continuous Radiated Disturbance	IEC 61000-4-3:2020	Criterion A
Electrical Fast Transient (EFT)	IEC 61000-4-4:2012, $\pm 0.5\text{kV}$, $\pm 1\text{kV}$, $\pm 2\text{kV}$	Criterion A
Surge	IEC61000-4-5:2014, L-N: $\pm 2\text{kV}$, L-E (Ground): $\pm 4\text{kV}$	Criterion A
Conducted Disturbances, Induced by RF Fields	IEC 61000-4-6:2013	Criterion A
Power Frequency Magnetic Field	IEC 61000-4-8:2009	Criterion A
Voltage Dips	IEC 61000-4-11:2004, Dip: 30% Reduction, Dip >95% Reduction	Criterion A
Voltage Interruptions	IEC 61000-4-11:2004, >95% Reduction	Criterion B
Application Note Link	CFM70S Series App Notes	

CHARACTERISTIC CURVE

Power Derating Curve

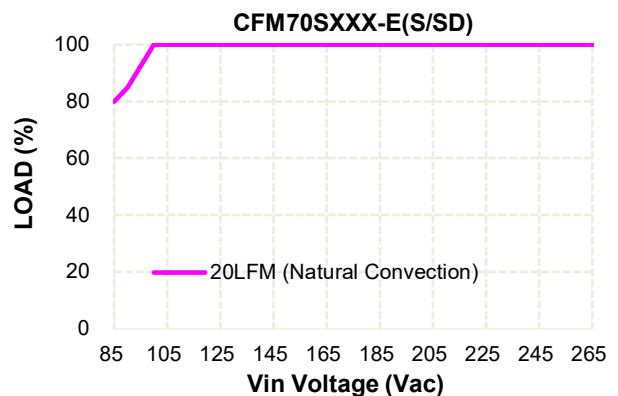
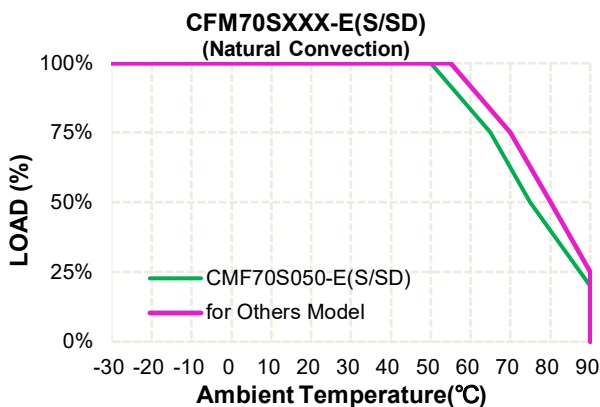
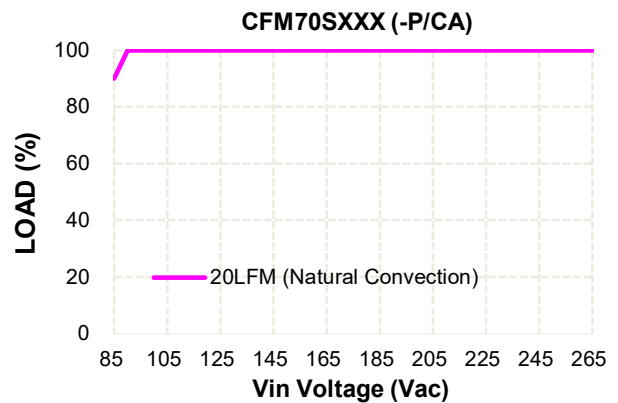
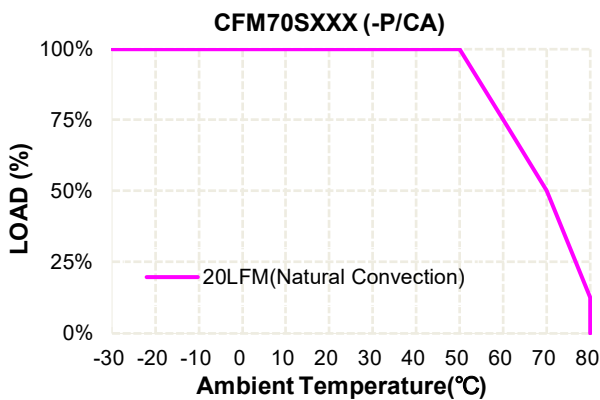



CFM70S Series

Performance Data

CFM70S050 (Eff Vs Io)

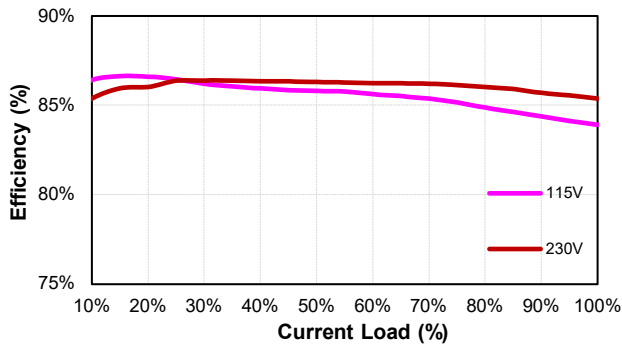

CFM70S120 (Eff Vs Io)

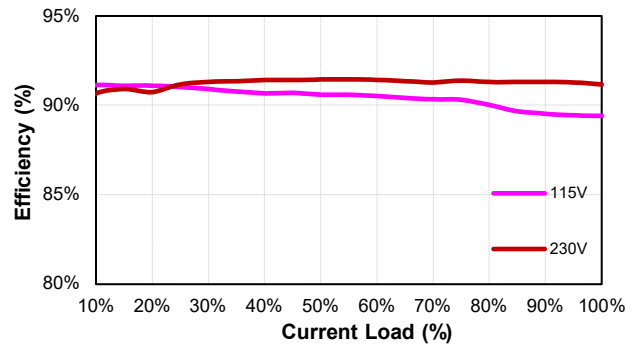

CFM70S150 (Eff Vs Io)

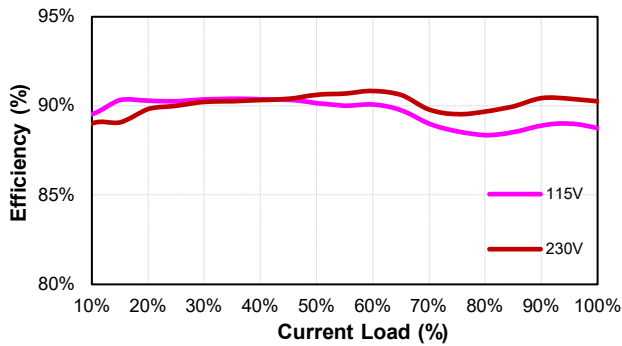

CFM70S240 (Eff Vs Io)

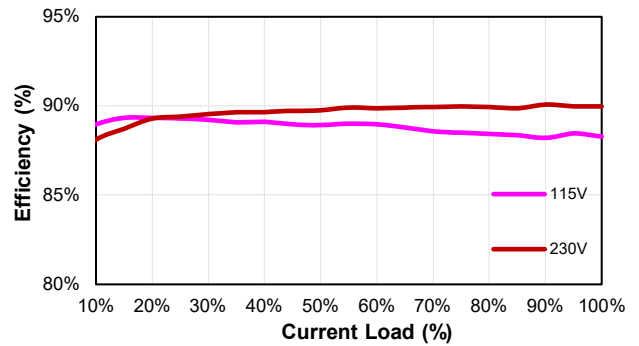

CFM70S360 (Eff Vs Io)

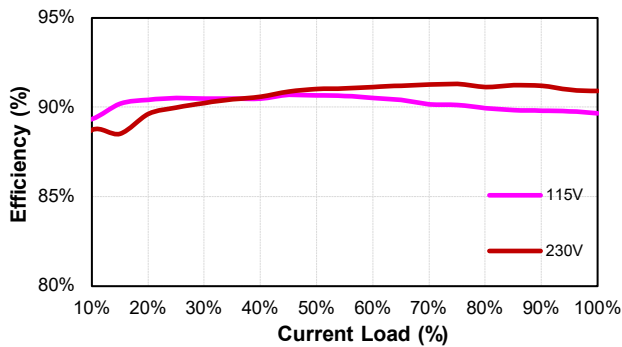

CFM70S480 (Eff Vs Io)

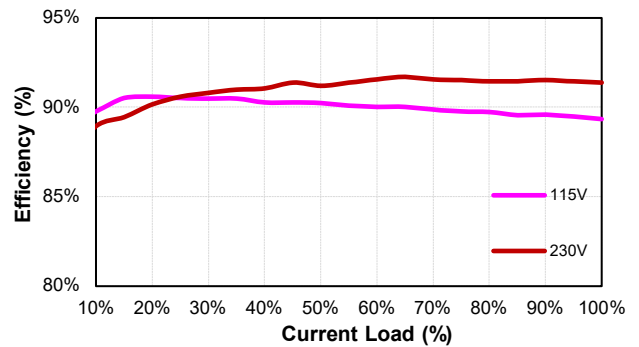



CFM70S Series

MECHANICAL SPECIFICATION

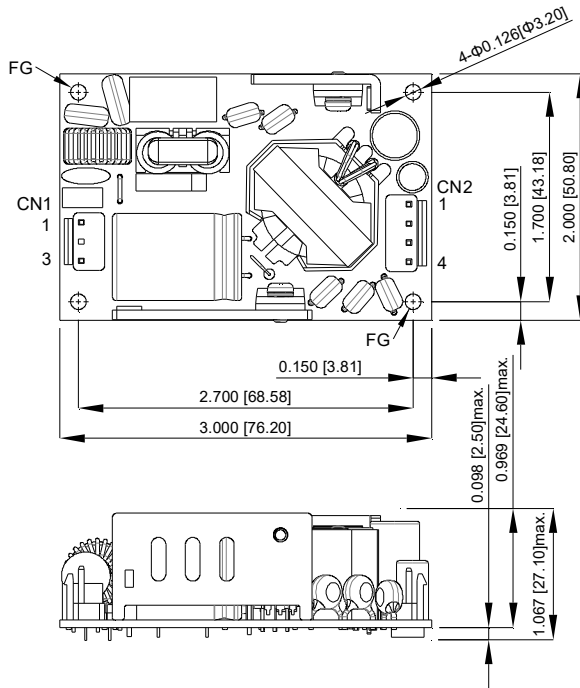

CFM70SXXX

AC Input Connector(CN1):TKP PVHI-03N2 or equivalent

Pin	Function	Mating Housing	Terminal
1	ACL	JST VHR-3N or equivalent	JST SVH-21T-P1.1 or equivalent
2	-		
3	ACN		

DC Output Connector(CN2):TKP PVHI-04 or equivalent

Pin	Function	Mating Housing	Terminal
1	+Vout	JST VHR-4N or equivalent	JST SVH-21T-P1.1 or equivalent
2	+Vout		
3	-Vout		
4	-Vout		

All Dimensions in Inches[mm]
 Tolerance Inches : X.XXX=±0.02
 Millimeters : X.XX=±0.5

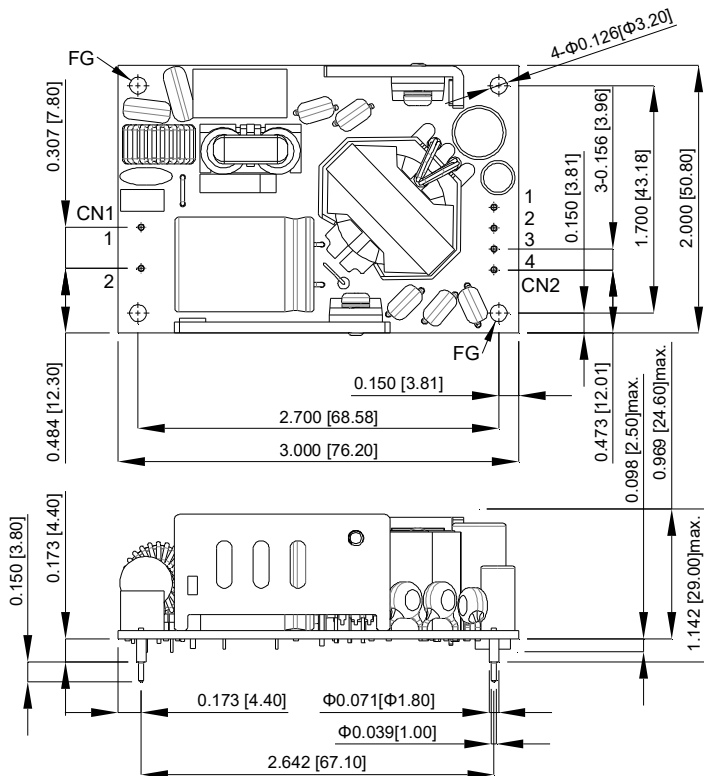

CFM70SXXX-P

CN1

PIN CONNECTION	
Pin	Function
1	ACL
2	ACN

CN2

PIN CONNECTION	
Pin	Function
1	+Vout
2	+Vout
3	-Vout
4	-Vout

All Dimensions in Inches[mm]
 Tolerance Inches : X.XXX=±0.02
 Millimeters : X.XX=±0.5



CFM70S Series

MECHANICAL SPECIFICATION

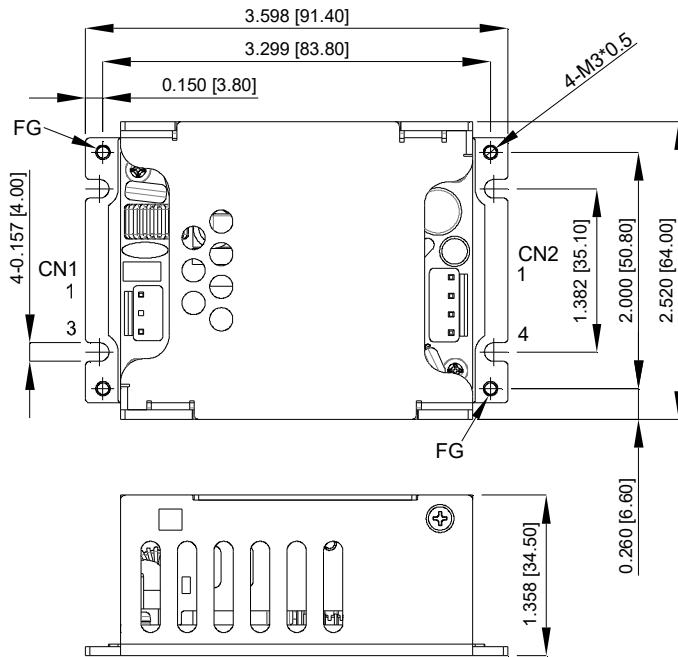

CFM70SXXX-CA

AC Input Connector(CN1):TKP PVHI-03N2 or equivalent

Pin	Function	Mating Housing	Terminal
1	ACL	JST VHR-3N or equivalent	JST SVH-21T-P1.1 or equivalent
2	-		
3	ACN		

DC Output Connector(CN2):TKP PVHI-04 or equivalent

Pin	Function	Mating Housing	Terminal
1	+Vout	JST VHR-4N or equivalent	JST SVH-21T-P1.1 or equivalent
2	+Vout		
3	-Vout		
4	-Vout		

All Dimensions in Inches[mm]
Tolerance Inches : X.XXX=±0.02
Millimeters : X.XX=±0.5

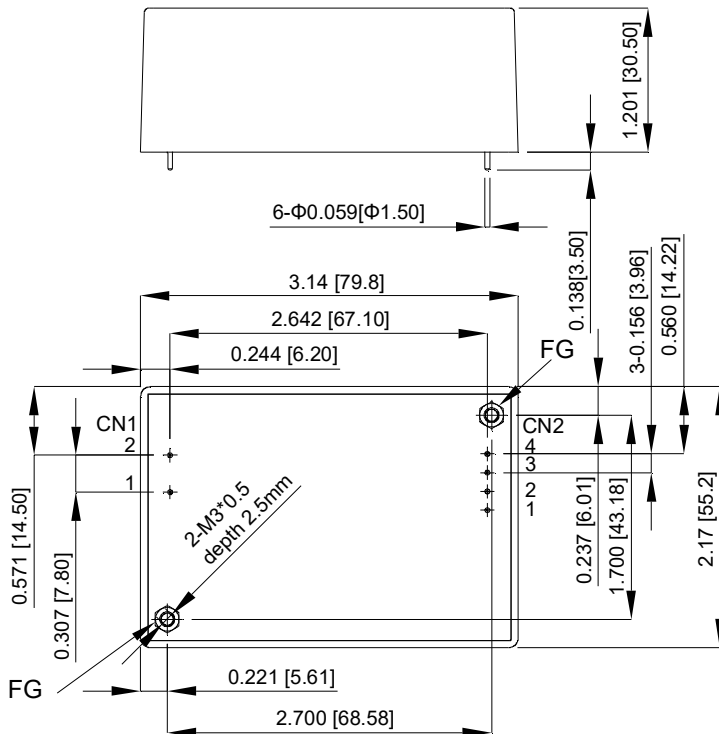

CFM70SXXX-E

PIN CONNECTION		
Pin	Function	Wafer
1	ACL	CN1
2	ACN	
1	+Vout	CN2
2	+Vout	
3	-Vout	
4	-Vout	

All Dimensions in Inches[mm]
Tolerance Inches : x.xx=±0.03,x.xxx=±0.02
Millimeters : x.x=±0.7,x.xx=±0.5



CFM70S Series

MECHANICAL SPECIFICATION

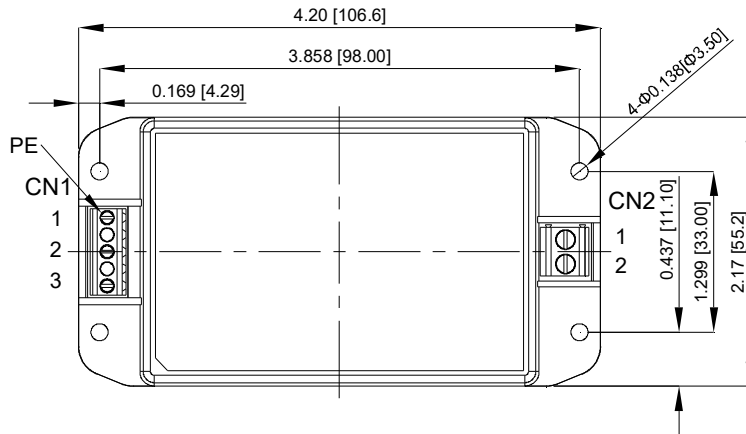

CFM70SXXX-S

AC Input Connector(CN1):DINKLE EK350V-03P5 or equivalent

Pin	Function	Mating Wire Range
1	PE	16~30 AWG
2	ACL	
3	ACN	

DC Output Connector(CN2):DINKLE EK500V-02P or equivalent

Pin	Function	Mating Wire Range
1	+Vout	12~16 AWG
2	-Vout	

All Dimensions in Inches[mm]
 Tolerance Inches: x.xx=±0.03, x.xxx=±0.020
 Millimeters: x.x=±0.7, x.xx=±0.50

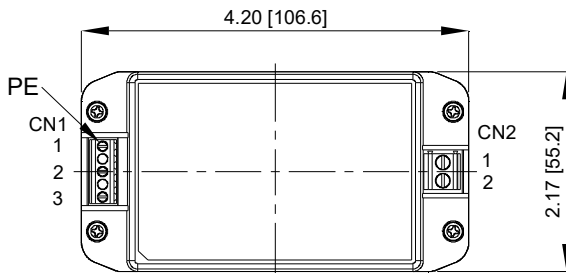
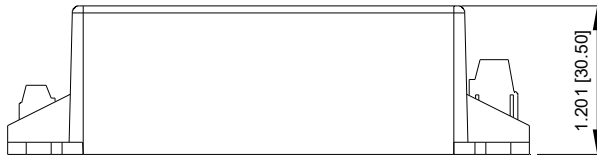

CFM70SXXX-SD

AC Input Connector(CN1):DINKLE EK350V-03P5 or equivalent

Pin	Function	Mating Wire Range
1	PE	16~30 AWG
2	ACL	
3	ACN	

DC Output Connector(CN2):DINKLE EK500V-02P or equivalent

Pin	Function	Mating Wire Range
1	+Vout	12~16 AWG
2	-Vout	

All Dimensions in Inches[mm]
 Tolerance Inches: x.xx=±0.03, x.xxx=±0.020
 Millimeters: x.x=±0.7, x.xx=±0.50

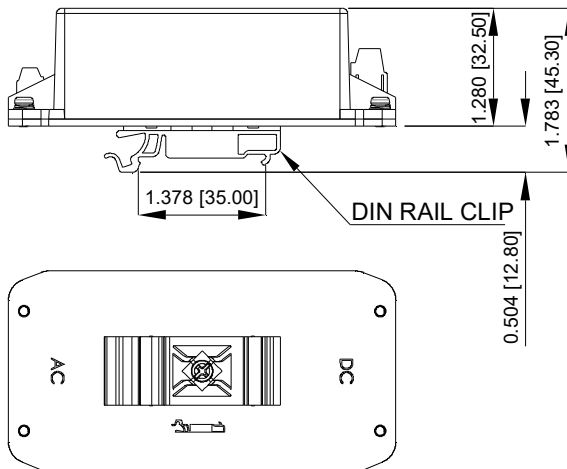

CINCON Electronics Co. Ltd.
 Add: 14F, No. 306, Sec.4, Hsin Yi Rd., Taipei, Taiwan
 Tel: 886-2-27086210
 Fax: 886-2-27029852
 E-mail: sales@cincon.com.tw
 Web: www.cincon.com

X-ON Electronics

Largest Supplier of Electrical and Electronic Components

Click to view similar products for [DIN Rail Power Supplies](#) category:

Click to view products by [Cincon](#) manufacturer:

Other Similar products are found below :

[PS-3015](#) [DVP01PU-S](#) [PS-C24024](#) [ADNB040-24-1PM-C](#) [SS14011524](#) [PSW-12024](#) [PSC-6024](#) [S8T-BUS03](#) [PS-S4024](#) [PS-10024](#) [PS-C12024](#)
[PSC-2024](#) [PSC-4048](#) [PSC-15124](#) [PSC-48148](#) [TRIO-PS-2G/1AC/12DC/5/C2LP](#) [PSS18/24/0.75](#) [PSD-A120W12](#) [NDR-7524](#) [NDR-12024](#)
[787-1200](#). [AMED75-48SJZ](#) [787-1007](#) [1SVR427043R1200](#) [50995](#) [50903](#) [50997](#) [EL50-D](#) [18924-9989](#) [50996](#) [HDN-3024](#) [ISED](#)
[1335699](#) [1335698](#) [POS DIN30W24](#) [SPB-015-12](#) [EL50-B](#) [50905](#) [DRB240-48-1](#) [CFM50S360-SD](#) [DRS-480-48](#) [POS DIN30W15](#) [POS](#)
[MDIN60W12](#) [18924-9988](#) [CFM70S480-SD](#) [HDN-3012](#) [DRB480-48-3-A1](#) [CFM50S240-SD](#) [DRB480-24-3-A0](#) [DRB240-24-3-A0](#)