



**CHASSIS MOUNT CQB50W12-72SXX-CMFC(D) Series
Application Note V11 November 2018**

**ISOLATED DC-DC CONVERTER
CHASSIS MOUNT
CQB50W12-72SXX-CMFC(D) SERIES
APPLICATION NOTE**



Approved By:

Department	Approved By	Checked By	Written By
Research and Development Department	Enoch	Danny	Wade
		Jacky	
Quality Assurance Department	Ryan	Benny	



CHASSIS MOUNT QCB50W12-72SXX-CMFC(D) Series Application Note V11 November 2018

Contents

1. Introduction	3
2. DC-DC Converter Features	3
3. Electrical Circuit Diagram	3
4. Terminal Block	3
5. Technical Specifications	4
6. Main Features and Functions	7
6.1 Operating Temperature Range	7
6.2 Output Voltage Adjustment	7
6.3 Over Current Protection	7
6.4 Output Over Voltage Protection	7
6.5 Remote On/Off	7
6.6 UVLO (Under Voltage Lock Out)	7
6.7 Over Temperature Protection	8
7. Applications	8
7.1 Connection for standard use	8
7.2 Convection Requirements for Cooling	8
7.3 Thermal Considerations	8
7.4 Derating	8
7.5 Power Derating	9
7.6 Hold up Time	11
7.7 Full Brick Heat Sinks:	12
7.8 Efficiency VS. Load	13
7.9 Test Set-Up	14
7.10 Output Voltage Adjustment	14
7.11 Output Remote Sensing	14
7.12 Output Ripple and Noise	15
7.13 Output Capacitance	15
7.14 Remote On/Off Circuit	15
8. Safety & EMC	16
8.1 Input Fusing and Safety Considerations	16
8.2 EMC Considerations	16
9. Part Number	21
10. Mechanical Specifications	21
10.1 Mechanical Outline Diagrams	21



CHASSIS MOUNT CQB50W12-72SXX-CMFC(D) Series Application Note V11 November 2018

1. Introduction

The CQB50W12-72SXX-CMFC(D) series of chassis mountable DC-DC converters offers 30-50 watts of output power @ single output voltages of 5, 12, 24, 48VDC. It has a wide (12:1) input voltage range of 14 to 160VDC (72VDC nominal) and 3000VDC basic isolation.

High efficiency up to 89%, allowing case operating temperature range of -40°C to 100°C . An optional heat sink is available to extend the full power range of the unit. Very low no load power consumption (8mA), an ideal solution for energy critical systems.

Built-in EMI EN50155, EN50121-3-2 filter. Meet EN45545. The standard control functions include remote on/off (positive or negative) and +10%, -20% adjustable output voltage.

Fully protected against input UVLO (under voltage lock out), Output over-current, output over-voltage and over-temperature and continuous short circuit conditions. CQB50W12-72SXX-CMFC(D) series is designed primarily for common railway applications of 24V, 36V, 48V, 72V, 96V, 110V nominal voltage and also suitable for distributed power architectures, telecommunications, battery operated equipment and industrial applications.

2. DC-DC Converter Features

- 30-50W Isolated Output
- Efficiency to 89%
- Fixed Switching Frequency
- 12:1 Input Range
- Regulated Outputs
- Remote On/Off
- Low No Load Power Consumption
- Over Temperature Protection
- Over Voltage/Current Protection
- Continuous Short Circuit Protection
- Shock & Vibration Meets EN50155 (EN61373)
- Safety Meets UL60950-1, EN60950-1 and IEC60950-1
- UL60950-1 2nd (Basic Insulation) Approval for DC Modules
- Meets EN50155:2007 for EMC, Environmental and Characteristic
- Build-In EMI Filter
- Baseplate Cooled
- Fire & Smoke Meets EN45545-2

3. Electrical Circuit Diagram

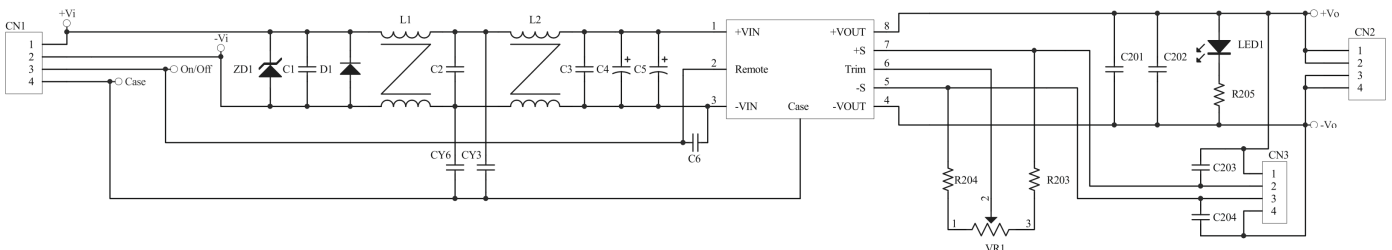

4. Terminal Block

Input and Output Terminal Block

Terminal Type	Screw Torque Value (Kgf-cm)	Suitable Electric Wire (AWG)	Current Rating (max.)
EK500V-XXP or Equivalent	5	12-24	20A



CHASSIS MOUNT CQB50W12-72SXX-CMFC(D) Series Application Note V11 November 2018

5. Technical Specifications

(All specifications are typical at nominal input, full load at 25°C unless otherwise noted.)

ABSOLUTE MAXIMUM RATINGS

PARAMETER	NOTES and CONDITIONS	Device	Min.	Typical	Max.	Units
Input Voltage						
Continuous		All	-0.3		160	V _{dc}
Transient	100ms	All			200	V _{dc}
Operating Case Temperature		All	-40		100	°C
Storage Temperature		All	-40		105	°C
Isolation Voltage	1 minute; input/output,	All			3000	V _{dc}
	1 minute; input/case,	All			2500	V _{dc}
	1 minute; output/case	All			500	V _{ac}

INPUT CHARACTERISTICS

PARAMETER	NOTES and CONDITIONS	Device	Min.	Typical	Max.	Units
Operating Input Voltage	14-16.8 VDC (t ≤ 60 sec.)	All	14	72	160	V _{dc}
Input Under Voltage Lockout						
Turn-On Voltage Threshold		All	14.2	14.6	15	V _{dc}
Turn-Off Voltage Threshold		All	11.6	12.6	13	V _{dc}
Lockout Hysteresis Voltage		All		2.0		V _{dc}
Maximum Input Current	100% Load, V _{in} =16.8V	72S05		2.3		A
		Other		4		A
No-Load Input Current		V _o =5V		8		mA
		V _o =12V		8		
		V _o =24V		8		
		V _o =48V		12		

OUTPUT CHARACTERISTICS

PARAMETER	NOTES and CONDITIONS	Device	Min.	Typical	Max.	Units
Output Voltage Set Point	V _{in} =Nominal V _{in} , I _o = I _{o_max} , T _c =25°C	V _o =5V	4.95	5	5.05	V _{dc}
		V _o =12V	11.88	12	12.12	
		V _o =24V	23.76	24	24.24	
		V _o =48V	47.52	48	48.48	
Output Voltage Regulation						
Load Regulation	I _o =I _{o_min} to I _{o_max}	All			±0.2	%
Line Regulation	V _{in} =low line to high line	All			±0.2	%
Temperature Coefficient	T _c =-40°C to 105°C	All			±0.02	%/°C
Output Voltage Ripple and Noise (5Hz to 20MHz bandwidth)						
Peak-to-Peak	Full load, 1uF ceramic capacitor. See 7.12	All			100	mV
RMS.		All			40	mV
Operating Output Current Range	V _{in} =low line to high line	V _o =5V	0		6	A
		V _o =12V	0		4.2	
		V _o =24V	0		2.1	
		V _o =48V	0		1.05	



CHASSIS MOUNT QCB50W12-72SXX-CMFC(D) Series Application Note V11 November 2018

PARAMETER	NOTES and CONDITIONS	Device	Min.	Typical	Max.	Units
Output DC Current Limit Inception	Hiccup Mode. Auto Recovery. See 6.3	All	110	180	220	%
Maximum Output Capacitance	Full load (resistive)	Vo=5V Vo=12V Vo=24V Vo=48V	0 0 0 0		10000 6800 3300 680	uF
Output Voltage Trim Range	P _{out} =max rated power, Trim Adj. Range (By VR1), See 7.10	All	-20		+10	%
Output Over Voltage Protection	Limited Voltage, See 6.4	All	115	125	140	%

DYNAMIC CHARACTERISTICS

PARAMETER	NOTES and CONDITIONS	Device	Min.	Typical	Max.	Units
Output Voltage Current Transient						
Error Band	75% to 100% of I _{o_max} step load change d _i /d _t =0.1A/us (within 1% V _{out} nominal)	All			±5	%
Recovery Time		All			250	us
Turn-On Delay and Rise Time	Full load (Constant resistive load)					
Turn-On Delay Time, From On/Off Control	V _{on/off} to 10%V _{o_set}	All		15		ms
Turn-On Delay Time, From Input	V _{in_min} to 10%V _{o_set}	All		15		ms
Output Voltage Rise Time	10%V _{o_set} to 90%V _{o_set}	All		10		ms

EFFICIENCY

PARAMETER	NOTES and CONDITIONS	Device	Min.	Typical	Max.	Units
100% Load	V _{in} =72V See 7.8	Vo=5V Vo=12V Vo=24V Vo=48V		83 87 89 88		%
	V _{in} =110V See 7.8	Vo=5V Vo=12V Vo=24V Vo=48V		81 86 87 85		%

ISOLATION CHARACTERISTICS

PARAMETER	NOTES and CONDITIONS	Device	Min.	Typical	Max.	Units
Isolation Voltage	1 minute; input/output	All			3000	V _{dc}
	1 minute; input/case,	All			2500	V _{dc}
	1 minute; output/case	All			500	V _{ac}
Isolation Resistance	Input / Output	All	200			MΩ
Isolation Capacitance	Input / Output	All		3000		pF
	Input/Case	All		5000		
	Output/Case	All		10000		

FEATURE CHARACTERISTICS

PARAMETER	NOTES and CONDITIONS	Device	Min.	Typical	Max.	Units
Switching Frequency	Pulse wide modulation (PWM), Fixed	All	215	240	265	KHz



CHASSIS MOUNT QCB50W12-72SXX-CMFC(D) Series Application Note V11 November 2018

PARAMETER	NOTES and CONDITIONS	Device	Min.	Typical	Max.	Units
On/Off Control, Positive Remote On/Off logic, Refer to –Vin pin.						
Logic Low (Module Off)	$V_{on/off}$ at $I_{on/off}=1.0mA$	All	0		1.2	V
Logic High (Module On)	$V_{on/off}$ at $I_{on/off}=0.0uA$	All	3.5 or Open Circuit		160	V
On/Off Control, Negative Remote On/Off logic, Refer to –Vin pin						
Logic High (Module Off)	$V_{on/off}$ at $I_{on/off}=0.0uA$	All	4 or Open Circuit		160	V
Logic Low (Module On)	$V_{on/off}$ at $I_{on/off}=1.0mA$	All	0		1.2	V
On/Off Current (for both remote on/off logic)	$I_{on/off}$ at $V_{on/off}=0.0V$	All		0.3	1	mA
Leakage Current (for both remote on/off logic)	Logic High, $V_{on/off}=15V$	All			30	uA
Off Converter Input Current	Shutdown input idle current	All		3	5	mA
Over Temperature Shutdown	Aluminum base plate temperature	All		110		°C
Over Temperature Recovery		All		100		°C

GENERAL SPECIFICATIONS

PARAMETER	NOTES and CONDITIONS	Device	Min.	Typical	Max.	Units
MTBF	$I_o=100\%$ of $I_{o,max}$; MIL-HDBK - 217F_Notice 1, GB, 25°C	$V_o=5V$		506		K hours
		$V_o=12V$		484		
		$V_o=24V$		515		
		$V_o=48V$		513		
Weight	QCB50W12-72SXX	-CMFC		210		grams
		-CMFD		296		
Base plate Material	Aluminum					
Potting Material	UL 94V-0(DC MODULE)					
Shock/Vibration	Meets EN50155 (EN61373)					
Humidity	95% RH max. Non Condensing					
Altitude	5000m Operating Altitude, 12000m Transport Altitude					
Thermal Shock	MIL-STD-810F					
Fire & Smoke	Meets EN45545-2					
EMI	Meets EN55011, EN55022 & EN50155(EN50121-3-2), See 8.2 , EN55032					Class A
ESD	EN61000-4-2	Level 3: Air $\pm 8kV$, Contact $\pm 6kV$				Perf. Criteria A
Radiated immunity	EN61000-4-3	Level 3: 80~1000MHz, 20V/m				Perf. Criteria A
Fast Transient	EN61000-4-4	Level 3: On power input port, $\pm 2kV$, See 8.1				Perf. Criteria A
Surge	EN61000-4-5	Level 4: Line to earth, $\pm 4kV$, Line to line, $\pm 2kV$				Perf. Criteria A
Conducted immunity	EN61000-4-6	Level 3: 0.15~80MHz, 10V				Perf. Criteria A
Interruptions of Voltage Supply	EN50155	Class S2:10ms Interruptions , See 7.6				Perf. Criteria A
Supply Change Over	EN50155	Class C2:During a supply break of 30 ms, See 7.6				Perf. Criteria B



CHASSIS MOUNT CQB50W12-72SXX-CMFC(D) Series Application Note V11 November 2018

6. Main Features and Functions

6.1 Operating Temperature Range

The CQB50W12-72SXX-CMFC(D) series converters can be operated within a wide case temperature range of -40°C to 100°C . Consideration must be given to the derating curves when ascertaining maximum power that can be drawn from the converter. The maximum power drawn from chassis mount models is influenced by usual factors, such as:

- Input voltage range
- Output load current
- Forced air or natural convection
- Heat sink optional

6.2 Output Voltage Adjustment

Section 7.10 describes in detail how to trim the output voltage with respect to its set point. The output voltage on all models is adjustable within the range of $+10\%$ to -20% .

6.3 Over Current Protection

All models have internal over current and continuous short circuit protection. The unit operates normally once the fault condition is removed. At the point of current limit inception, the converter will go into hiccup mode protection.

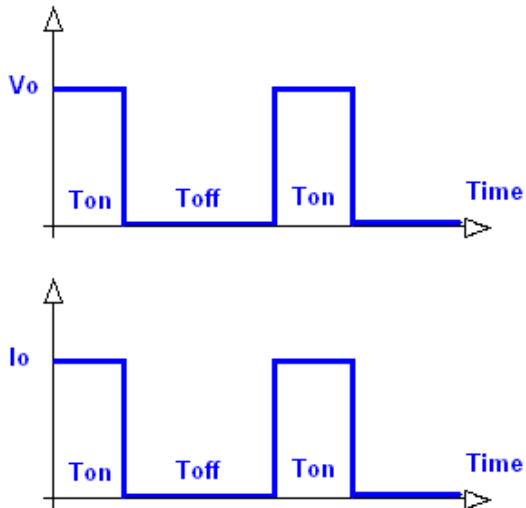

6.4 Output Over Voltage Protection

The output over voltage protection consists of circuitry that internally limits the output voltage. If more accurate output over voltage protection is required then an external circuit can be used via the remote on/off pin.

Note: Please note that device inside the power supply might fail when voltage more than rate output voltage is applied to output pin. This could happen when the customer tests the over voltage protection of unit.

6.5 Remote On/Off

The CQB50W12-72SXX-CMFC(D) series allows the user to switch the module on and off electronically with the remote on/off feature. All models are available in “positive logic” and “negative logic” (optional) versions. The converter turns on if the remote on/off pin is high ($>3.5\text{Vdc}$ to 160Vdc or open circuit). Setting the pin low (0 to $<1.2\text{Vdc}$) will turn the converter off. The signal level of the remote on/off input is defined with respect to ground. If not using the remote on/off pin, leave the pin open (converter will be on). Models with part number suffix “N” are the “negative logic” remote on/off version. The unit turns off if the remote on/off pin is high ($>4.0\text{Vdc}$ to 160Vdc or open circuit). The converter turns on if the on/off pin input is low (0 to $<1.2\text{Vdc}$). Note that the converter is off by default. See 7.14

Logic State (Pin 2)	Negative Logic	Positive Logic
Logic Low – Switch Closed	Module on	Module off
Logic High – Switch Open	Module off	Module on

6.6 UVLO (Under Voltage Lock Out)

Input under voltage lockout is standard on the CQB50W12-72SXX-CMFC(D) unit. The unit will shut down when the input voltage drops below a threshold, and the unit will operate when the input voltage goes above the upper threshold.

**CQB50W12-72SXX-CMFC(D)
Iin Vs Vin**

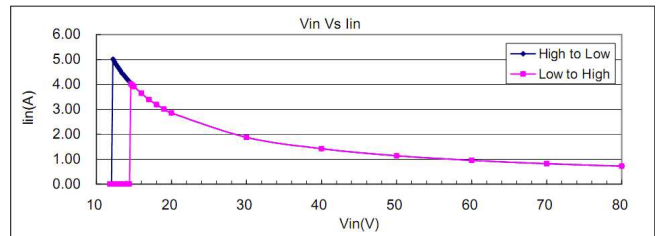



CHASSIS MOUNT CQB50W12-72SXX-CMFC(D) Series Application Note V11 November 2018

6.7 Over Temperature Protection

These modules have an over temperature protection circuit to safeguard against thermal damage. Shutdown occurs with the maximum case reference temperature is exceeded. The module will restart when the case temperature falls below over temperature recovery threshold. Please measured at point A. (Measuring point A refer to the following figure)

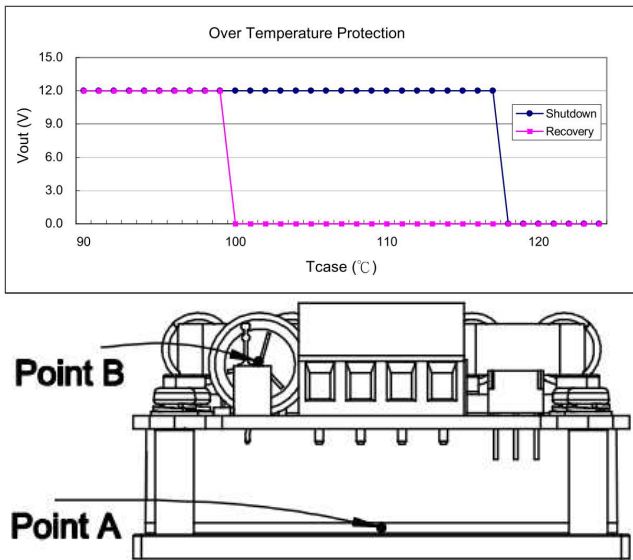

7. Applications

7.1 Connection for standard use

The connection for standard use is shown below. An external output capacitors (C1) is recommended to reduce output ripple and noise, output capacitor recommended 1 uF ceramic capacitor.

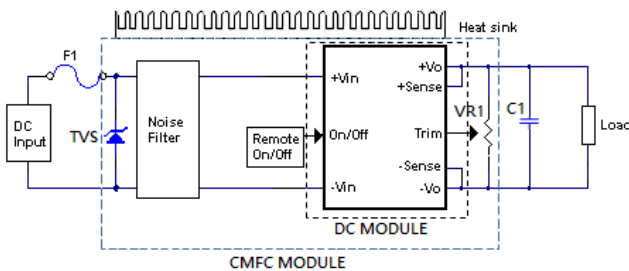

Symbol	Component	Reference
F1	Input fuse	Section 8.1
Noise Filter	Internal input noise filter	Section 8.2
Remote On/Off	External Remote On/Off control	Section 7.14
Trim	Internal output voltage adjustment By variable resistor	Section 7.10
Heat sink	External heat sink	Section 7.4/7.5/7.7
+Sense/-Sense	--	Section 7.11

7.2 Convection Requirements for Cooling

To predict the approximate cooling needed for the quarter brick module, refer to the power derating curves in **section 7.5**. These derating curves are approximations of the ambient temperatures and airflows required to keep the power module temperature below its maximum rating. Once the module is assembled in the actual system, the module's aluminum plate (point A) and aluminum capacitor (point B) temperature should be monitored to ensure it does not exceed 100°C.

7.3 Thermal Considerations

The power module operates in a variety of thermal environments; however, sufficient cooling should be provided to help ensure reliable operation of the unit. Heat is removed by conduction, convection, and radiation to the surrounding environment. The example is presented in **section 7.5**. The power output of the module should not be allowed to exceed rated power ($V_{o_set} \times I_{o_max}$).

7.4 Derating

The following figures are ambient derating curve of CQB50W12-72SXX-CMFC(D) based on the aluminum base plate temperature. When operating the CQB50W12-72SXX-CMFC(D) series, proper derating or cooling is needed. The maximum case temperature under any operating condition should not exceed 100°C. (Measuring point A and measuring point B refer to the **section 6.7**)

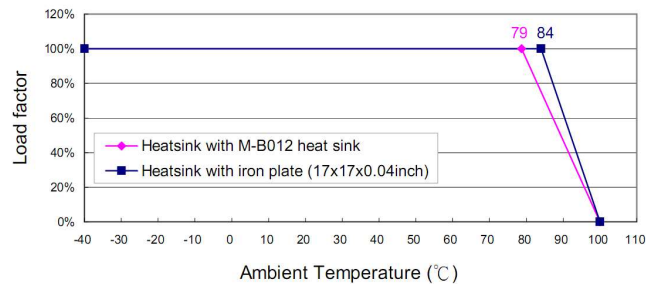

Ambient Derating Curves at Nominal Line, Full Load and Natural Convection.



CHASSIS MOUNT QCB50W12-72SXX-CMFC(D) Series Application Note V11 November 2018

7.5 Power Derating

The operating case temperature range of QCB50W12-72SXX-CMFC(D) series is -40°C to $+100^{\circ}\text{C}$. When operating the QCB50W12-72SXX-CMFC(D) series, proper derating or cooling is needed. The maximum case temperature under any operating condition should not exceed 100°C .

The following curve is the de-rating curve of QCB50W12-72SXX-CMFC(D) series with heat sink. The test condition refer to following figures.

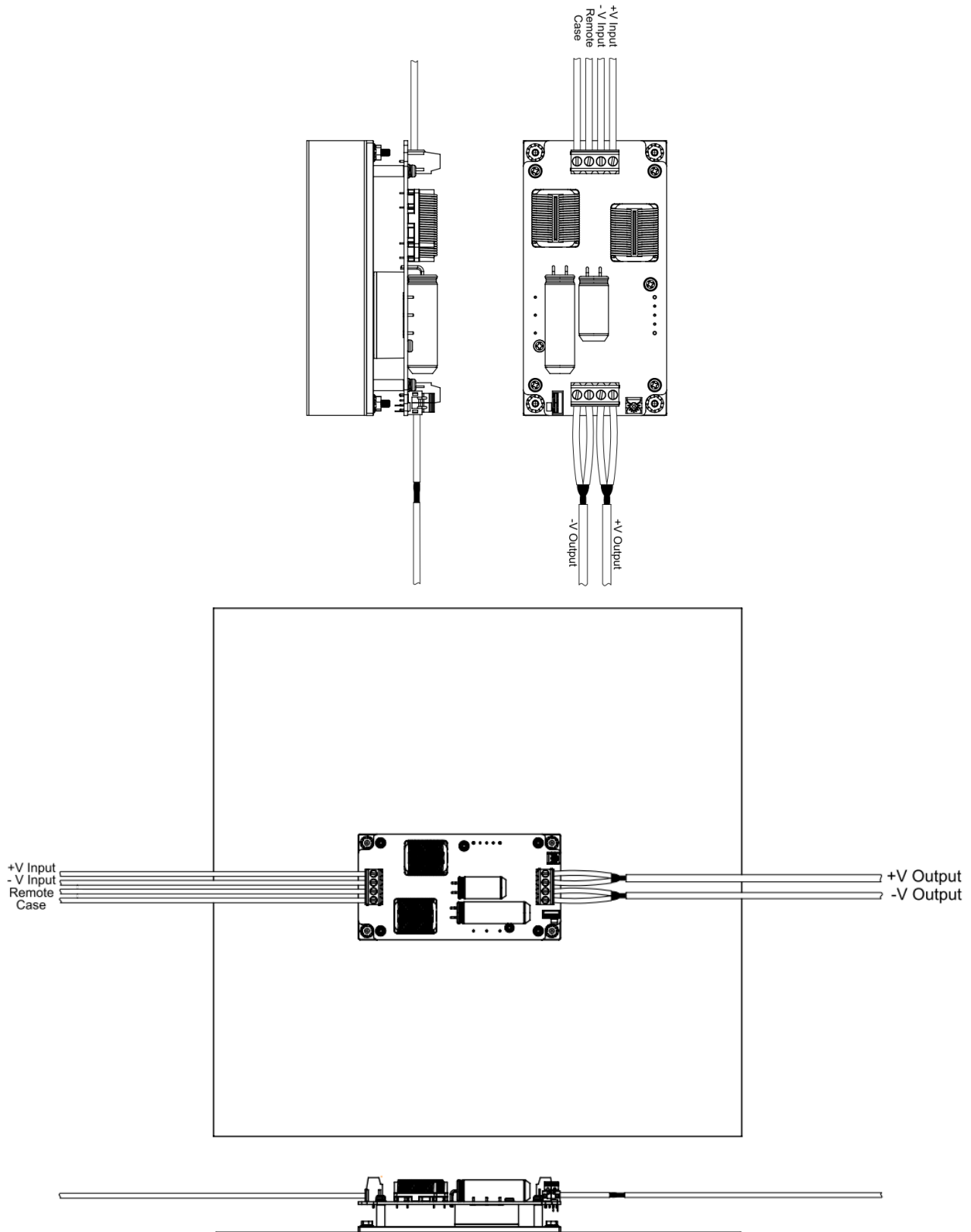



CHASSIS MOUNT CQB50W12-72SXX-CMFC(D) Series Application Note V11 November 2018

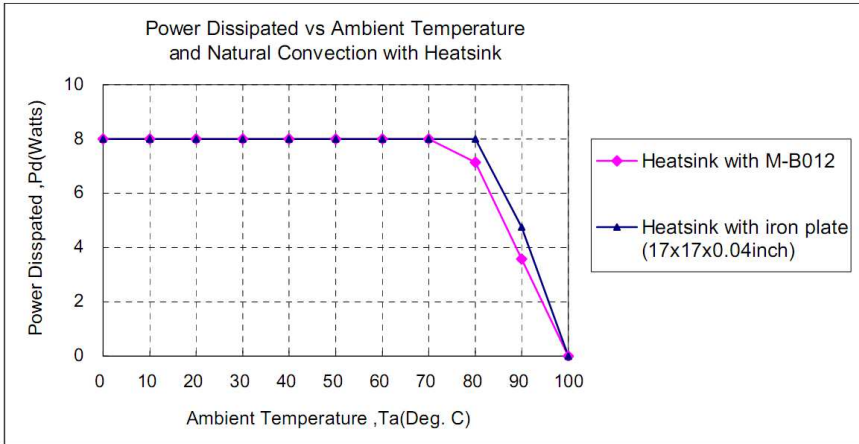

HEATSINKS	TYPICAL R _{ca}
Heatsink with M-B012	2.8 °C/W
Heatsink with iron plate (17x17x0.04inch)	2.1 °C/W

Example (with heat sink M-B012):

How to make a CQB50W12-72S12-CMFC operating at nominal line voltage, an output current of 4.2A, and a maximum ambient temperature of 70°C ?

Solution:

Given:

$$V_{in}=72V_{dc}, V_o=12V_{dc}, I_o=4.2A$$

Determine Power dissipation (P_d):

$$P_d=P_i-P_o=P_o(1-\eta)/\eta$$

$$P_d=12.0 \times 4.2 \times (1-0.87)/0.87=7.53Watts$$

Determine airflow:

$$\text{Given: } P_d=7.53W \text{ and } T_a=70^\circ C$$

Check above Power de-rating curve:

Heat sink with M-B012

Verify:

$$\text{Maximum temperature rise is } \Delta T = P_d \times R_{ca}=7.53 \times 2.8=21.1^\circ C$$

$$\text{Maximum case temperature is } T_c=T_a+\Delta T=91.1^\circ C < 100^\circ C$$

Where:

The R_{ca} is thermal resistance from case to ambient environment.

T_a is ambient temperature and T_c is case temperature.



CHASSIS MOUNT QCB50W12-72SXX-CMFC(D) Series Application Note V11 November 2018

7.6 Hold up Time

Hold up time is defined as the duration of time that DC/DC converter output will remain active following a loss of input power.

The test condition and test curve refer to following figures.

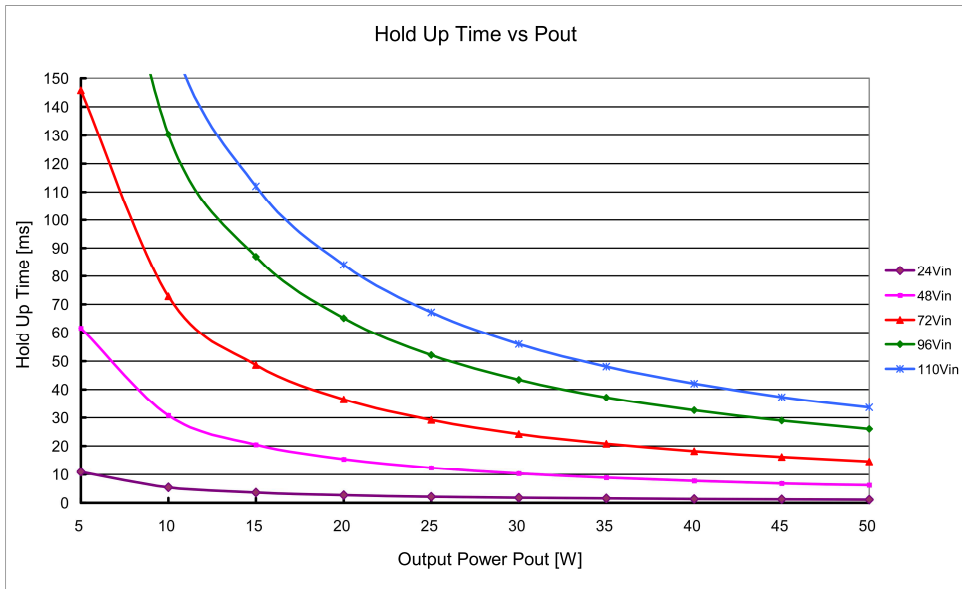
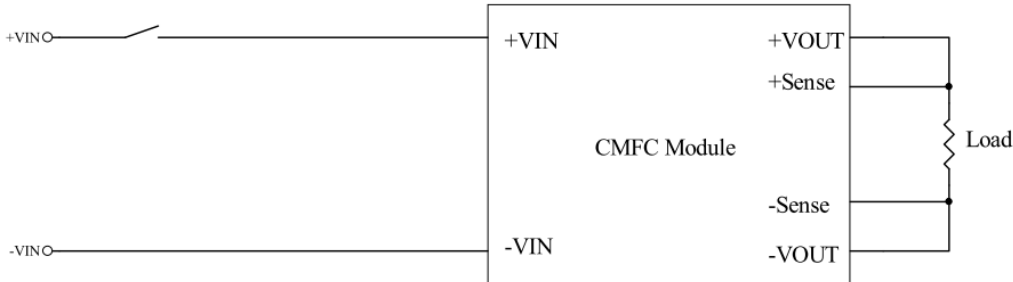

The external circuit about extend hold up time refer to following figure.

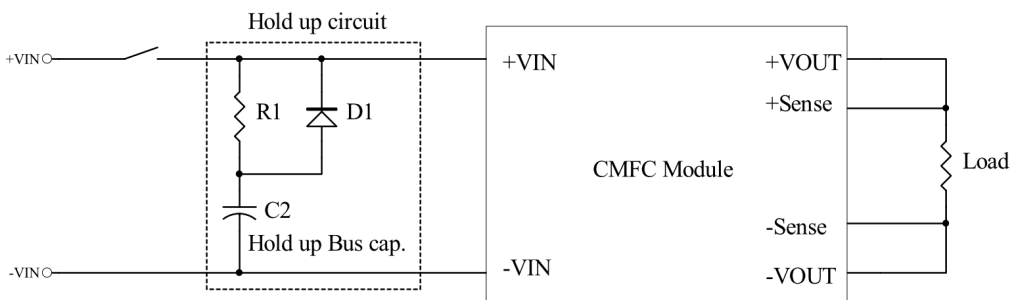

D1:200V/10A
R1:100Ω/10W

C2	24Vin	48Vin	72Vin	96Vin
Hold up time for 10ms	3300uF	360uF	NC	NC
Hold up time for 30ms	9600uF	1700uF	540uF	150uF



CHASSIS MOUNT QCB50W12-72SXX-CMFC(D) Series Application Note V11 November 2018

7.7 Full Brick Heat Sinks:

Heat-sink M-B012

All Dimension In mm

Longitudinal Fins

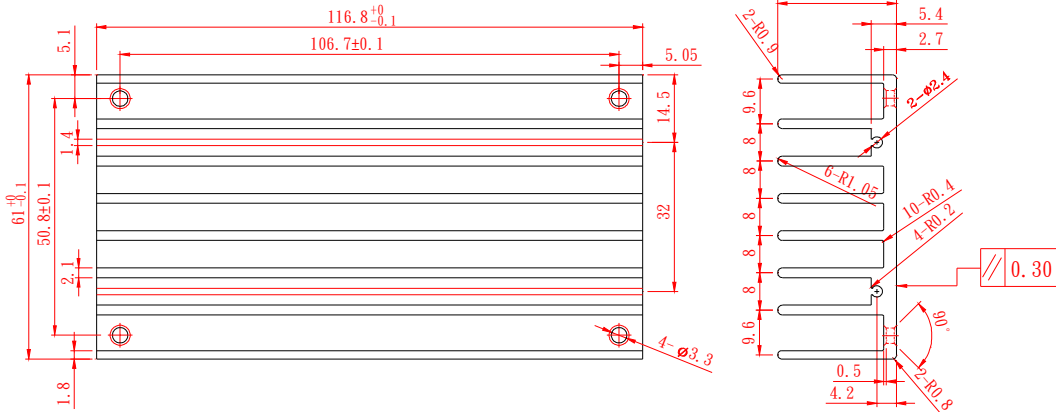

Heat Sink (Clear Mounting Inserts Φ 3.3mm Through): 116.8*61*25.4(M-B012) (G6620090204)
 Thermal PAD: PMP-P400 60*115.8*0.23 (G6135041073)
 Screw: M3*20L (G75A1300052)
 Nut: NH+WOM3*P0.5N(G75A2440392)

Heat-sink M-C997

All Dimension In mm

Longitudinal Fins

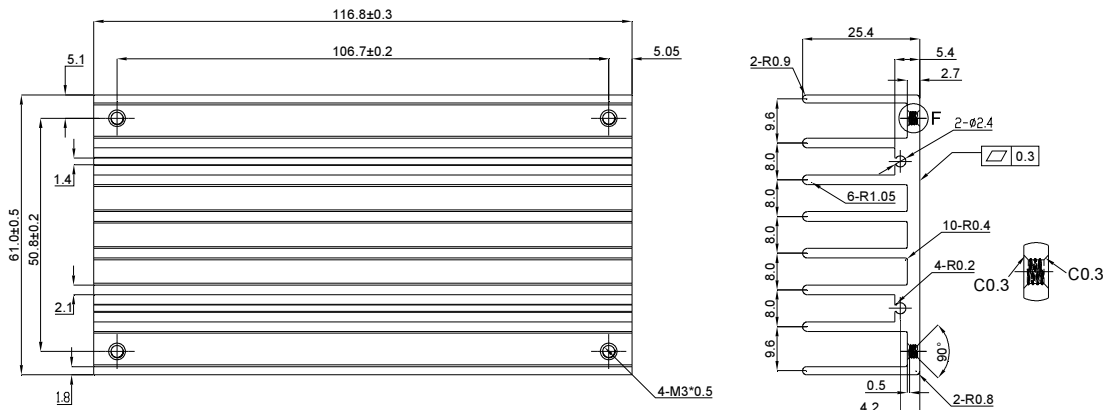

Heat Sink (Mounting Inserts M3*0.5 Through): 116.8*61*25.4(M-C997) (G6620980201)
 Thermal PAD: PMP-P400 60*115.8*0.23 (G6135041073)
 Screw: M3*20L (G75A1300052)
 Washer: WS3.2N (G75A47A0752)

AIR FLOW RATE	TYPICAL R _{ca}
Natural Convection	2.4 °C/W
20ft./min. (0.1m/s)	1.76 °C/W
100 ft./min. (0.5m/s)	1.17 °C/W
200 ft./min. (1.0m/s)	1.00 °C/W
300 ft./min. (1.5m/s)	0.83 °C/W
400 ft./min. (2.0m/s)	



CHASSIS MOUNT QQB50W12-72SXX-CMFC(D) Series Application Note V11 November 2018

7.8 Efficiency VS. Load

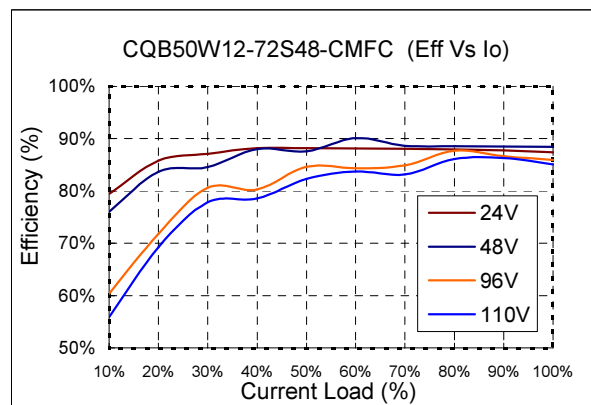
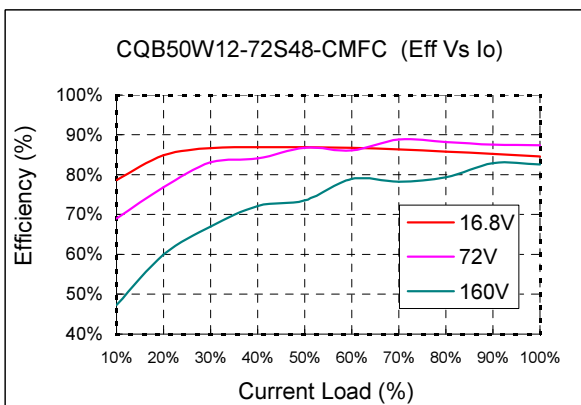
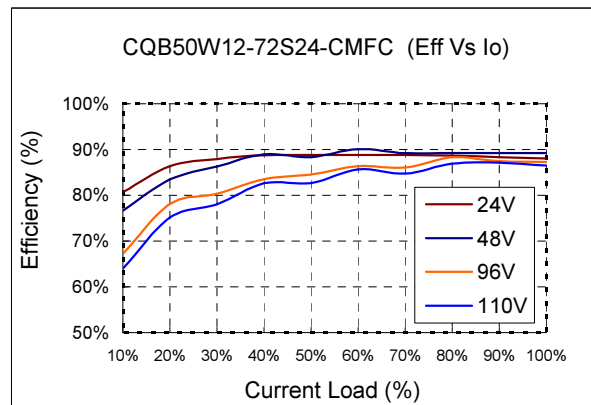
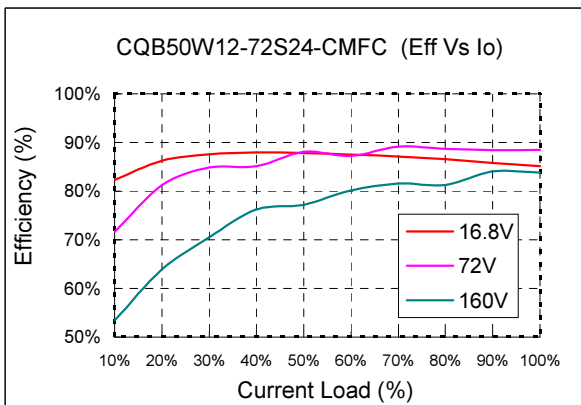
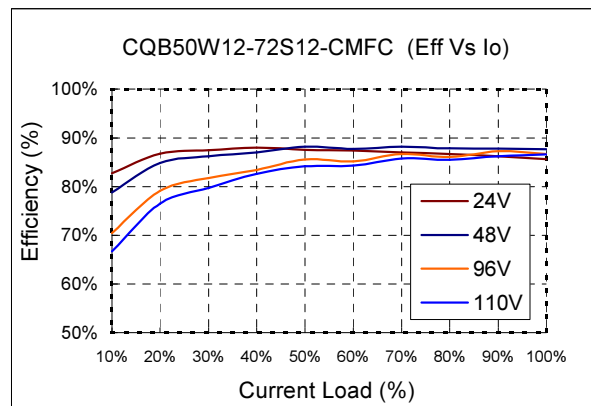
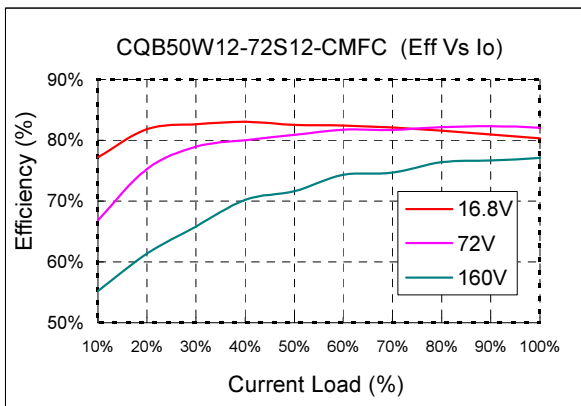
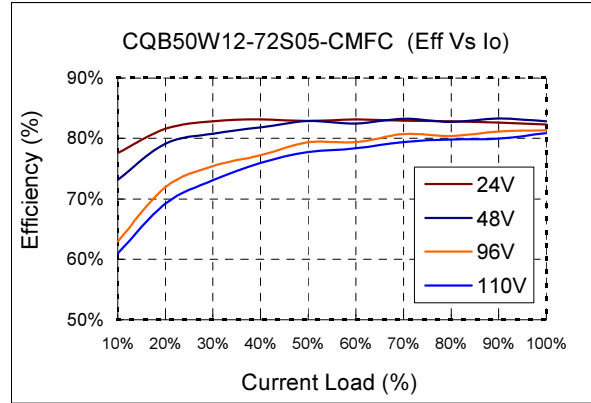
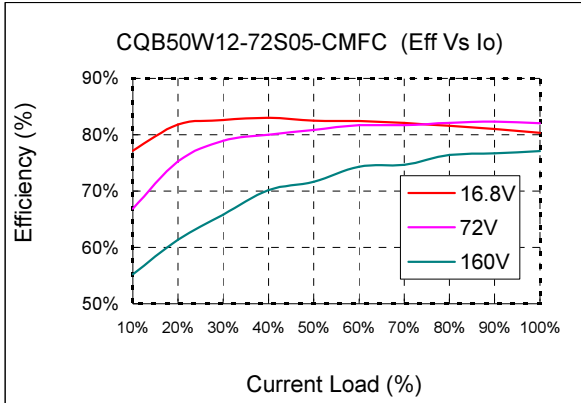



CHASSIS MOUNT QCB50W12-72SXX-CMFC(D) Series Application Note V11 November 2018

7.9 Test Set-Up

The basic test set-up to measure parameters such as efficiency and load regulation is shown below. When testing the modules under any transient conditions please ensure that the transient response of the source is sufficient to power the equipment under test. We can calculate:

- Efficiency
- Load regulation and line regulation.

The value of efficiency is defined as:

$$\eta = \frac{V_o \times I_o}{V_{in} \times I_{in}} \times 100\%$$

Where:

- V_o is output voltage,
- I_o is output current,
- V_{in} is input voltage,
- I_{in} is input current.

The value of load regulation is defined as:

$$Load.reg = \frac{V_{FL} - V_{NL}}{V_{NL}} \times 100\%$$

Where:

- V_{FL} is the output voltage at full load.
- V_{NL} is the output voltage at no load.

The value of line regulation is defined as:

$$Line.reg = \frac{V_{HL} - V_{LL}}{V_{LL}} \times 100\%$$

Where: V_{HL} is the output voltage of maximum input voltage at full load. V_{LL} is the output voltage of minimum input voltage at full load.

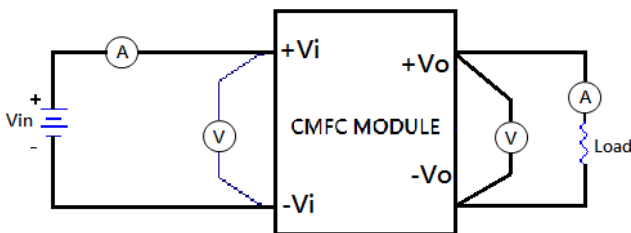

QCB50W12-72SXX-CMFC(D) Series Test Setup

7.10 Output Voltage Adjustment

Output may be externally trimmed (-20%,+10%) with a variable resistance as shown. Output voltage can be adjusted by internal variable resistor. Turning internal variable resistor clockwise reduces the output voltage and counterclockwise increases the output voltage.

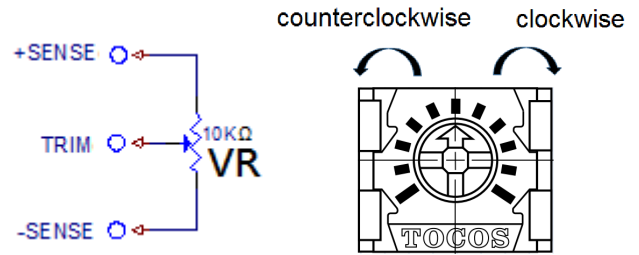

7.11 Output Remote Sensing

The QCB50W12-72SXX-CMFC(D) series converter has the capability to remotely sense both lines of its output. This feature moves the effective output voltage regulation point from the output of the unit to the point of connection of the remote sense pins. This feature automatically adjusts the real output voltage of the QCB50W12-72SXX-CMFC(D) series in order to compensate for voltage drops in distribution and maintain a regulated voltage at the point of load. The remote-sense voltage range is:

$$[(+V_{out}) - (-V_{out})] - [(+Sense) - (-Sense)] \leq 10\% \text{ of } V_{o_nominal}$$

When remote sensing is used, please remove the jumper of CN3. When remote sense is in use, the sense should be connected by twisted-pair wire or shield wire. If the sensing patterns short, heavy current flows and the pattern may be damaged. Output voltage might become unstable because of impedance of wiring and load condition when length of wire is exceeding 400mm. This is shown in the schematic below.

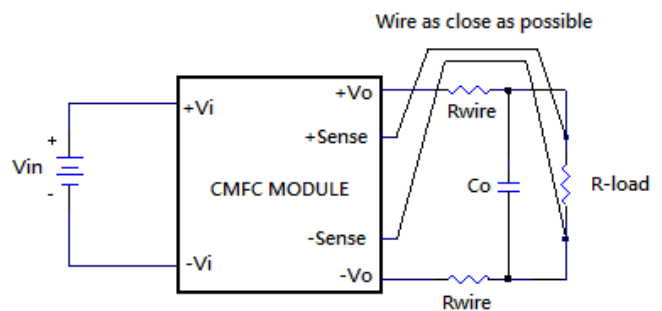

When the CMFC module are shipped from a factory, they come with a dedicated jumper being mounted on CN3. If the remote sense feature is not to be used, the sense pins should be connected locally. The +Sense pin should be connected to the +Vout pin at the module and the -Sense pin should be connected to the -Vout pin at the module. Wire between +Sense and +Vout and between -Sense and -Vout as short as possible. Loop wiring should be avoided. The converter might become unstable by noise coming from poor wiring. This is shown in the schematic below.



CHASSIS MOUNT QCB50W12-72SXX-CMFC(D) Series Application Note V11 November 2018

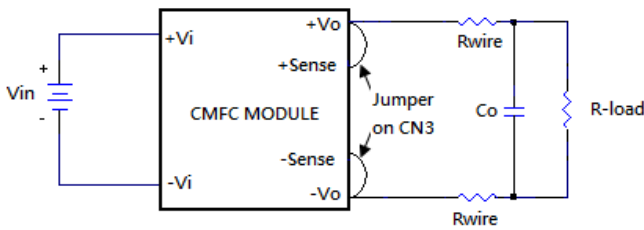

Note: Although the output voltage can be varied (increased or decreased) by both remote sense and trim, the maximum variation for the output voltage is the larger of the two values not the sum of the values. The output power delivered by the module is defined as the voltage at the output terminals multiplied by the output current. Using remote sense and trim can cause the output voltage to increase and consequently increase the power output of the module if output current remains unchanged. Always ensure that the output power of the module remains at or below the maximum rated power. Also be aware that if $V_{o,set}$ is below nominal value, $P_{out,max}$ will also decrease accordingly because $I_{o,max}$ is an absolute limit. Thus, $P_{out,max} = V_{o,set} \times I_{o,max}$ is also an absolute limit.

7.12 Output Ripple and Noise

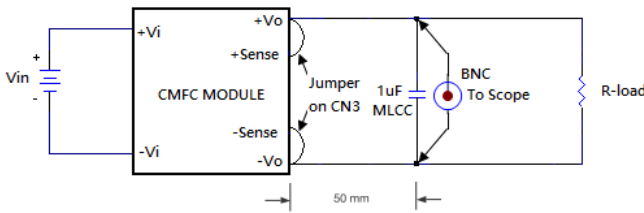

Output ripple and noise measured with 1uF ceramic capacitors across output. A 20 MHz bandwidth oscilloscope is normally used for the measurement.

The conventional ground clip on an oscilloscope probe should never be used in this kind of measurement. This clip, when placed in a field of radiated high frequency energy, acts as an antenna or inductive pickup loop, creating an extraneous voltage that is not part of the output noise of the converter.

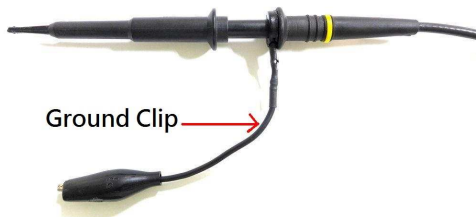

Another method is shown in below, in case of coaxial-cable/BNC is not available. The noise pickup is eliminated by pressing scope probe ground ring directly against the -Vout terminal while the tip contacts the +Vout terminal. This makes the shortest possible connection across the output terminals.

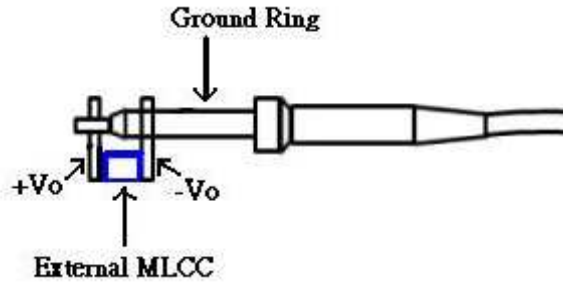

7.13 Output Capacitance

The QCB50W12-72SXX-CMFC(D) series converters provide unconditional stability with or without external capacitors. For good transient response, low ESR output capacitors should be located close to the point of load (<100mm). PCB design emphasizes low resistance and inductance tracks in consideration of high current applications. Output capacitors with their associated ESR values have an impact on loop stability and bandwidth. Cincon's converters are designed to work with load capacitance to see technical specifications.

7.14 Remote On/Off Circuit

The converter remote On/Off circuit built-in on input side. The ground pin of input side Remote On/Off circuit is -Vin pin. Refer to 6.5 for more details. Connection examples see below.

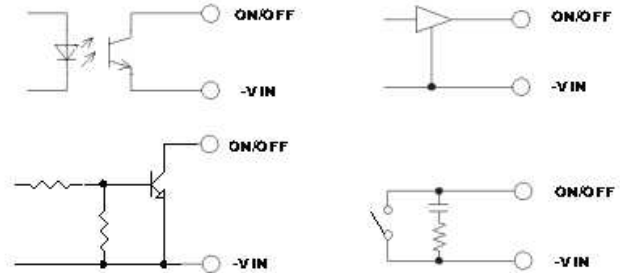

Remote On/Off Connection Example



CHASSIS MOUNT QQB50W12-72SXX-CMFC(D) Series Application Note V11 November 2018

8. Safety & EMC

8.1 Input Fusing and Safety Considerations

The QQB50W12-72SXX-CMFC(D) series converters have no internal fuse. In order to achieve maximum safety and system protection, always use an input line fuse. We recommended a 6A time delay fuse for all models. CMFC module have a transient voltage suppressor diode (TVS) across the input terminal to protect the unit against surge or spike voltage and input reverse voltage (as shown).

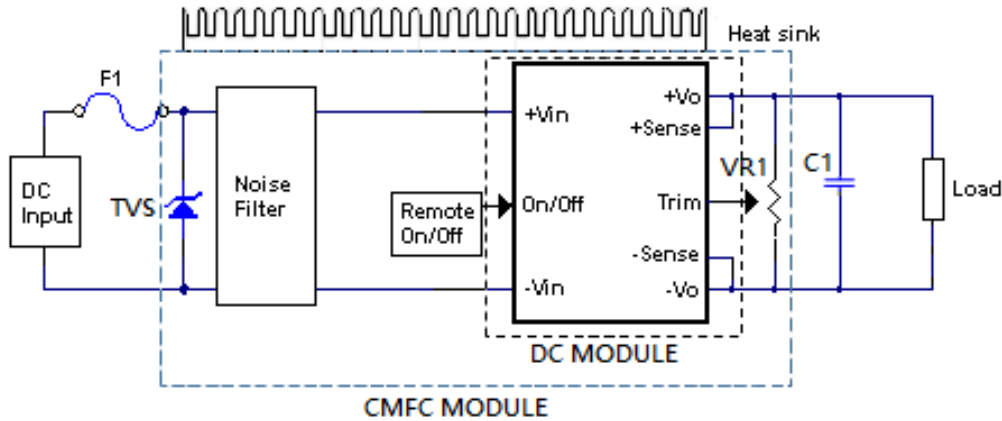

8.2 EMC Considerations

EMI Test standard: EN50121-3-2 Conducted & Radiated Emission

Test Condition: Input Voltage: 110Vdc, Output Load: Full Load

(1) EMI meet EN55011 / EN55022 / EN50121-3-2:2006/EN55032

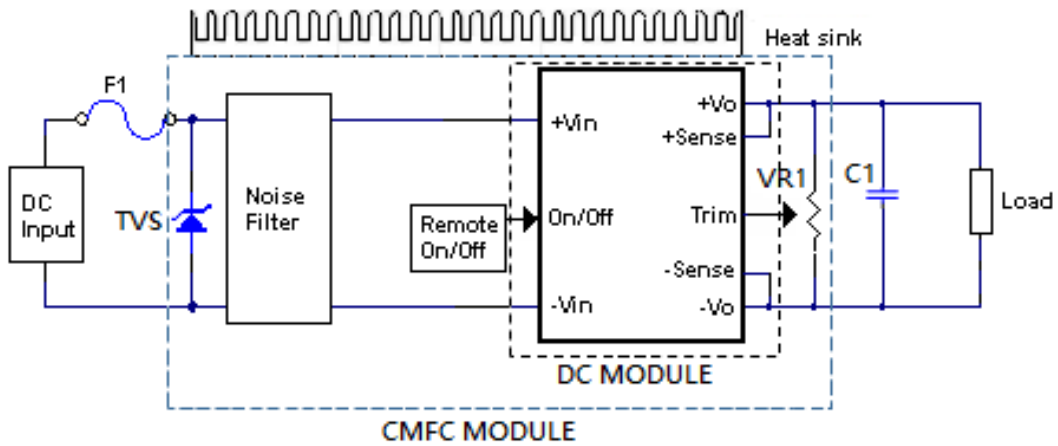

Connection circuit for conducted EMI testing



CHASSIS MOUNT CQB50W12-72SXX-CMFC(D) Series Application Note V11 November 2018

Conducted Emission:

CQB50W12-72S05-CMFC
Line

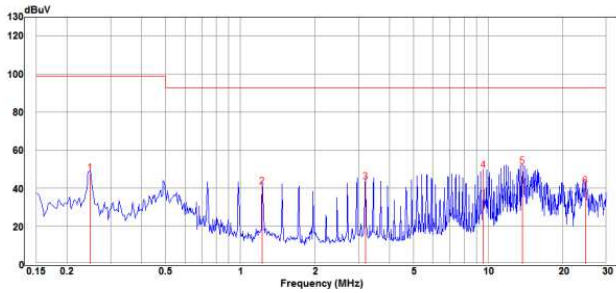

CQB50W12-72S05-CMFC
Neutral

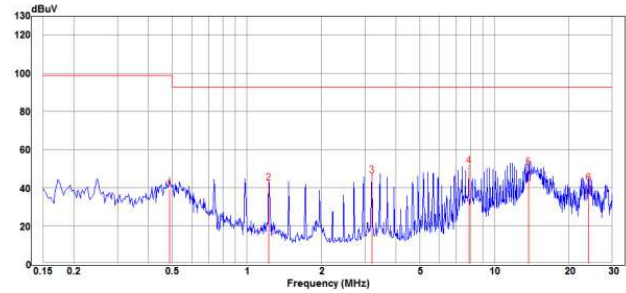

CQB50W12-72S12-CMFC
Line

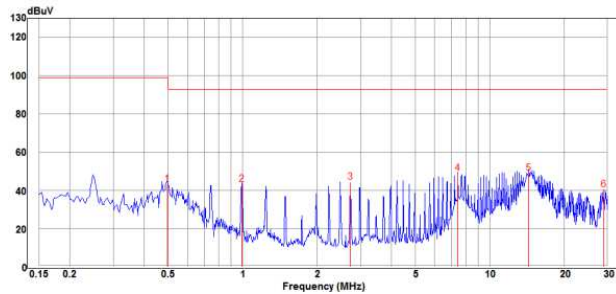

CQB50W12-72S12-CMFC
Neutral

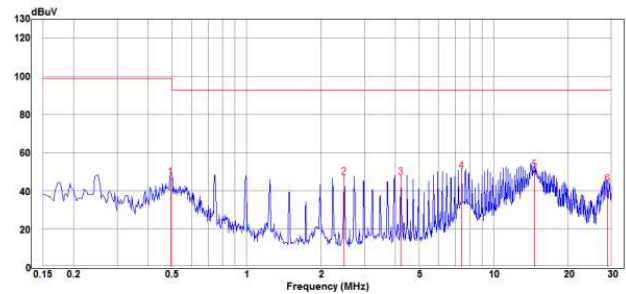

CQB50W12-72S24-CMFC
Line

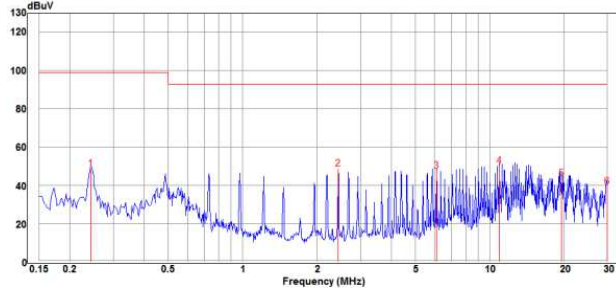

CQB50W12-72S24-CMFC
Neutral

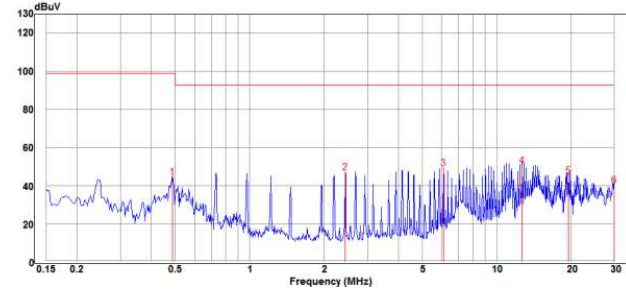

CQB50W12-72S48-CMFC
Line

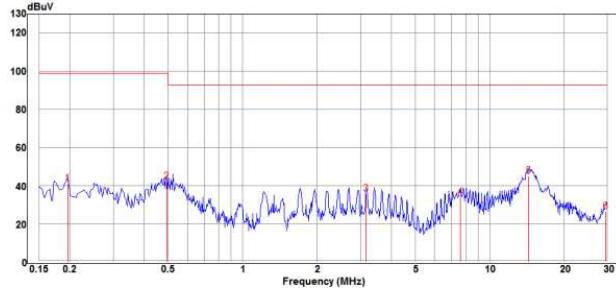

CQB50W12-72S48-CMFC
Neutral

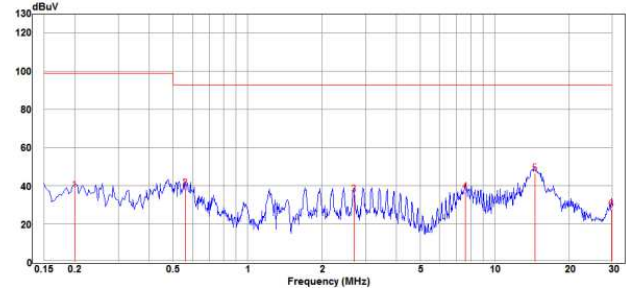



CHASSIS MOUNT CQB50W12-72SXX-CMFC(D) Series Application Note V11 November 2018

Radiated Emission:

CQB50W12-72S05-CMFC

Vertical

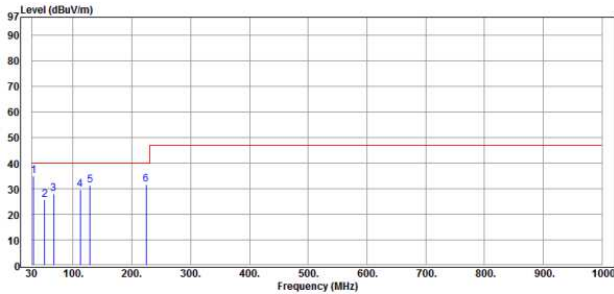

CQB50W12-72S05-CMFC

Horizontal

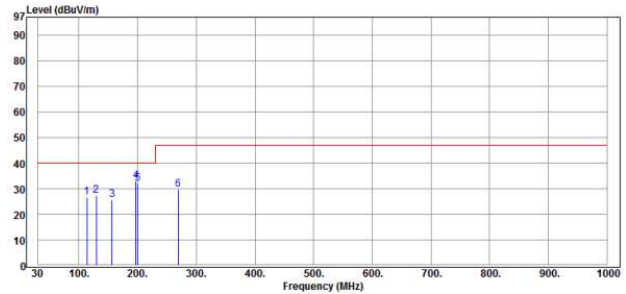

CQB50W12-72S12-CMFC

Vertical

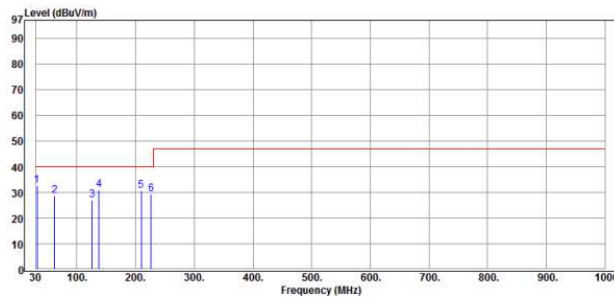

CQB50W12-72S12-CMFC

Horizontal

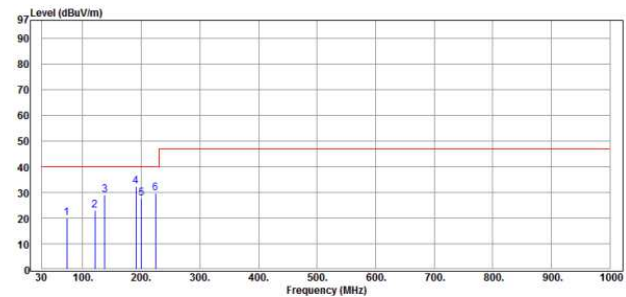

CQB50W12-72S24-CMFC

Vertical

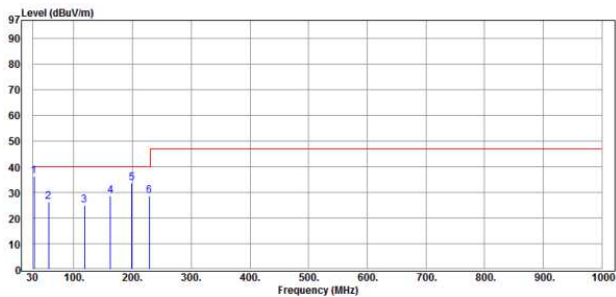

CQB50W12-72S24-CMFC

Horizontal

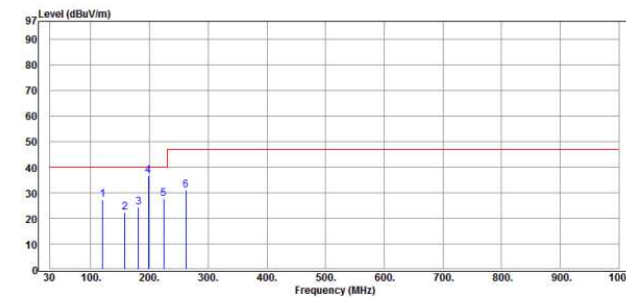

CQB50W12-72S48-CMFC

Vertical

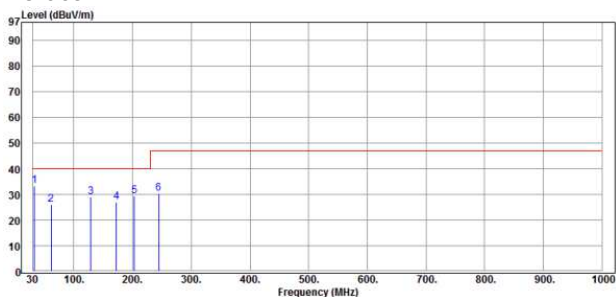

CQB50W12-72S48-CMFC

Horizontal

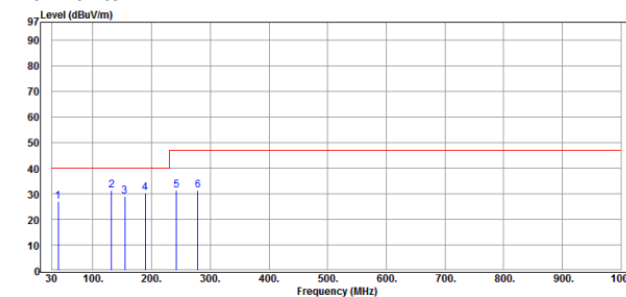



CHASSIS MOUNT QQB50W12-72SXX-CMFC(D) Series Application Note V11 November 2018

(2) The external filter is required for output conducted noise meet EN50121-3-2:2015:

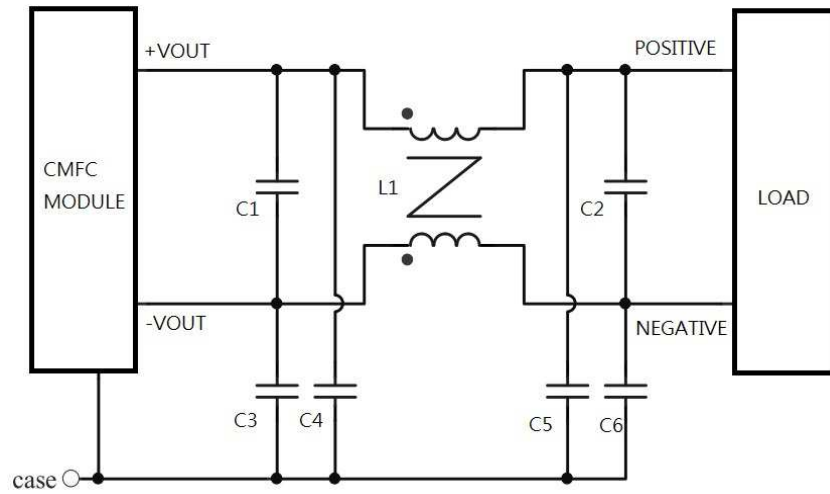

Connection circuit for conducted EMI Class A testing

Note:

C1, C2 are 2.2 μ F/100V ceramic capacitors

C3, C4, C5, C6 are 0.047 μ F/1KV ceramic capacitors.

L1: 0.4mH (Core P/N: CM15*10*4.5, Winding: 1.0mm*2/4Turns) or equivalent



CHASSIS MOUNT CQB50W12-72SXX-CMFC(D) Series Application Note V11 November 2018

CQB50W12-72S05-CMFC

Positive

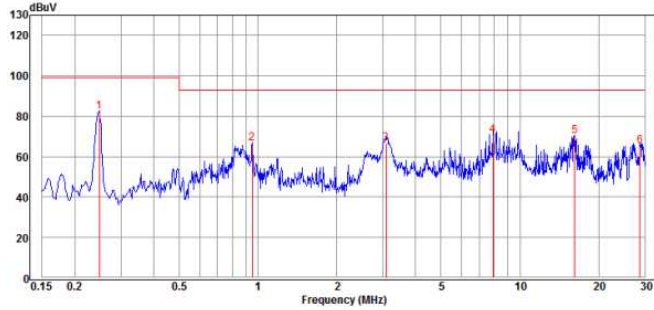

CQB50W12-72S05-CMFC

Negative

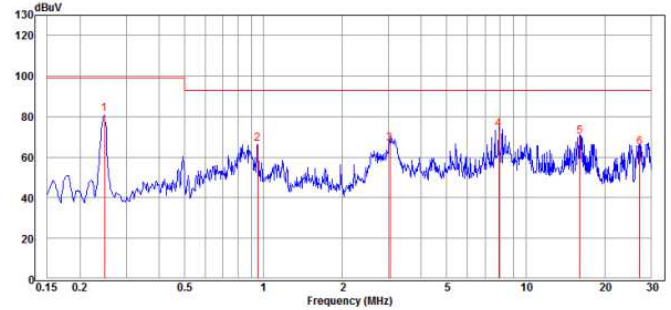

CQB50W12-72S12-CMFC

Positive

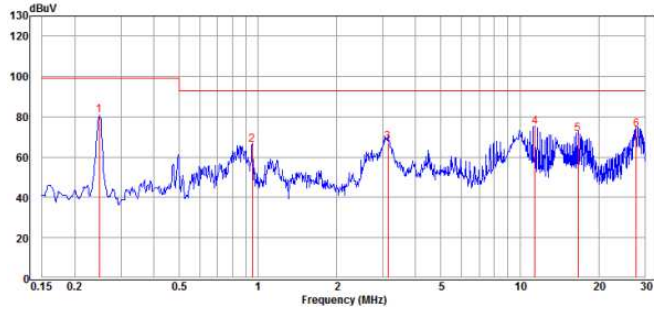

CQB50W12-72S12-CMFC

Negative

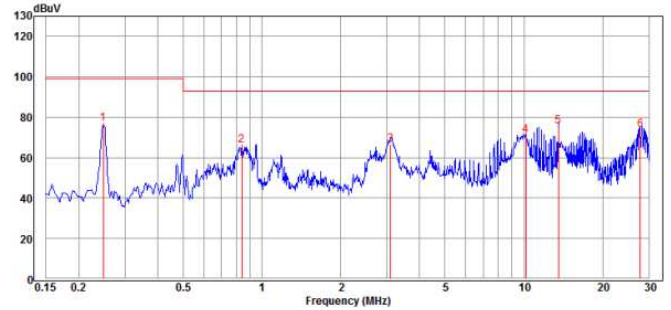

CQB50W12-72S24-CMFC

Positive

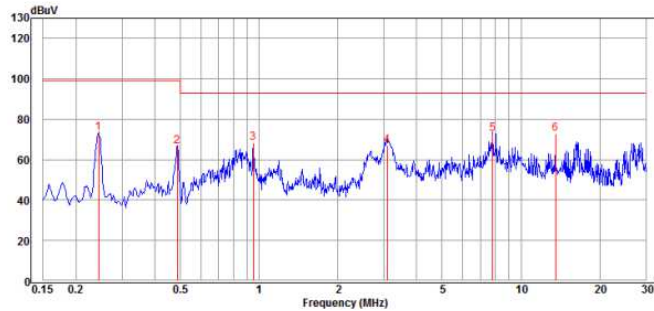

CQB50W12-72S24-CMFC

Negative

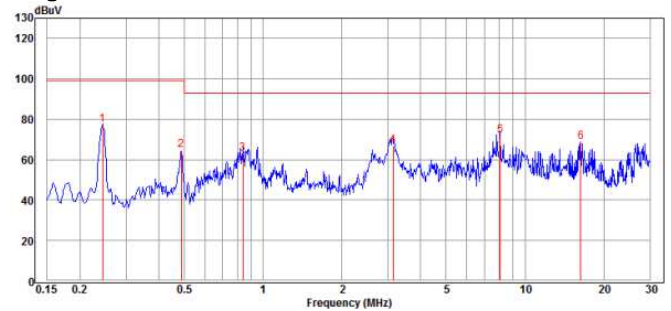

CQB50W12-72S48-CMFC

Positive

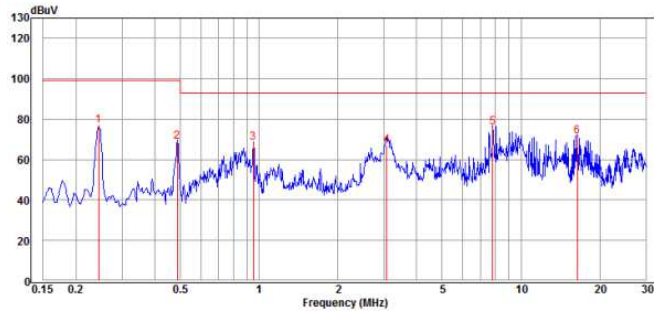

CQB50W12-72S48-CMFC

Negative

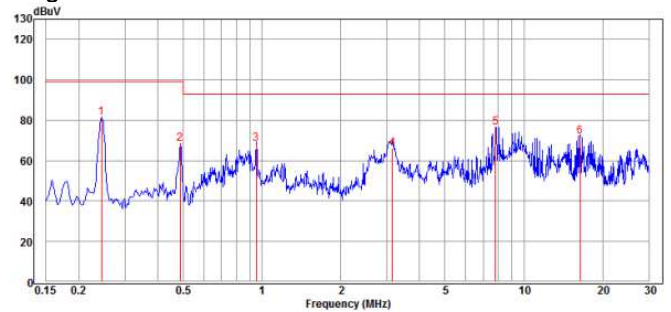



CHASSIS MOUNT QQB50W12-72SXX-CMFC(D) Series Application Note V11 November 2018

9. Part Number

Format: CQB50W12 – III OXXL-YYYY

Parameter	Series	Nominal Input Voltage	Number of Outputs	Output Voltage	Remote On/Off Logic	Chassis Mount Type	
Symbol	CQB50W12-	III	O	XX	L	YYY	Z (Option)
Value	CQB50W12-	72: 72 Volts	S: Single	05: 5.0 Volts 12: 12 Volts 24: 24 Volts 48: 48 Volts	None: Positive N: Negative	CMF: Chassis Mount Built in Filter	C: Open Frame D: With Cover

10. Mechanical Specifications

10.1 Mechanical Outline Diagrams

All Dimensions in Inches(mm)
Tolerance Inches: x.xx=±0.02, X.XXX=±0.010
Millimeters: x.x=±0.5, XXX=±0.25

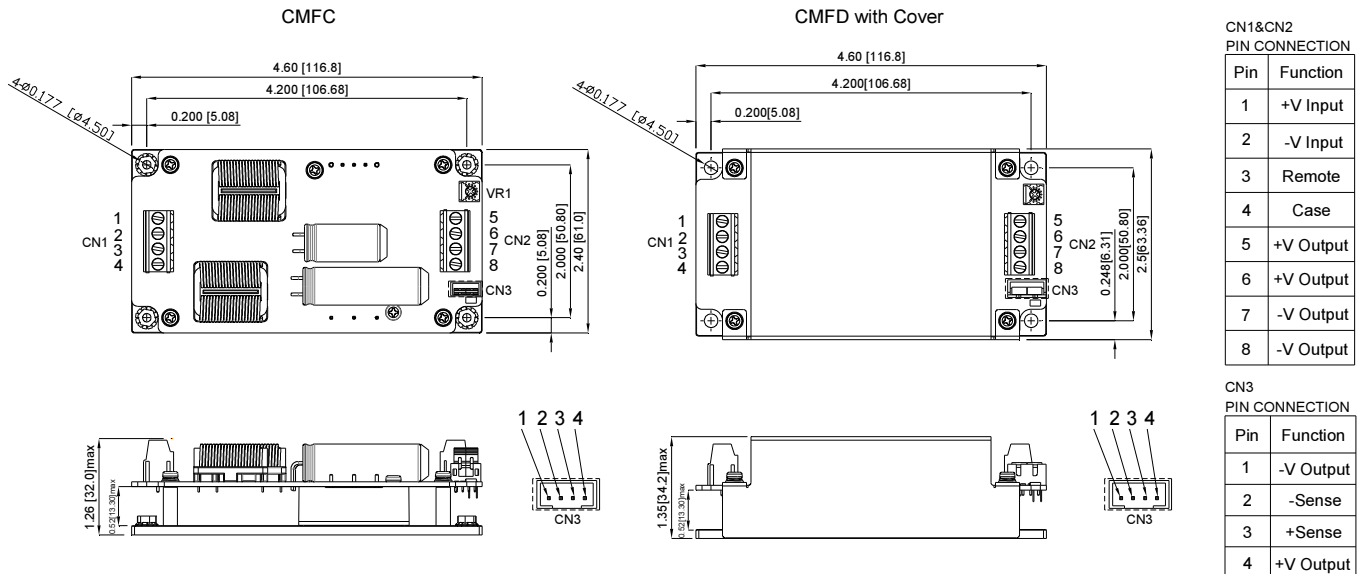

CQB50W12-72SXX-CMFC(D) Mechanical Outline Diagram

CINCON ELECTRONICS CO., LTD.

Headquarters:

14F, No.306, Sec.4, Hsin Yi Rd.
Taipei, Taiwan
Tel: 886-2-27086210
Fax: 886-2-27029852
E-mail: support@cincon.com.tw
Web Site: <http://www.cincon.com>

Factory:

No. 8-1, Fu Kung Rd.
Fu Hsing Industrial Park
Fu Hsing Hsiang,
ChangHua Hsien, Taiwan
Tel: 886-4-7690261
Fax: 886-4-7698031

Cincon North America:

1655Mesa Verde Ave. Ste 180
Ventura, CA93003
Tel: 805-639-3350
Fax: 805-639-4101
E-mail: info@cincon.com

X-ON Electronics

Largest Supplier of Electrical and Electronic Components

Click to view similar products for [Isolated DC/DC Converters](#) category:

Click to view products by [Cincon](#) manufacturer:

Other Similar products are found below :

[ESM6D044440C05AAQ](#) [FMD15.24G](#) [PSL486-7LR](#) [Q48T30020-NBB0](#) [JAHW100Y1](#) [SPB05C-12](#) [SQ24S15033-PS0S](#) [18952](#) [19-130041](#)
[CE-1003](#) [CE-1004](#) [GQ2541-7R](#) [RDS180245](#) [MAU228](#) [J80-0041NL](#) [DFC15U48D15](#) [XGS-0512](#) [XGS-1205](#) [XGS-1212](#) [XGS-2412](#) [XGS-2415](#) [XKS-1215](#) [06322](#) [NCT1000N040R050B](#) [SPB05B-15](#) [SPB05C-15](#) [L-DA20](#) [DCG40-5G](#) [QME48T40033-PGB0](#) [XKS-2415](#) [XKS-2412](#)
[XKS-1212](#) [XKS-1205](#) [XKS-0515](#) [XKS-0505](#) [XGS-2405](#) [XGS-1215](#) [XGS-0515](#) [PS9Z-6RM4](#) [73-551-5038I](#) [AK1601-9RT](#) [VI-N61-CM](#) [VI-R5022-EXWW](#) [PSC128-7iR](#) [RPS8-350ATX-XE](#) [DAS1004812](#) [PQA30-D24-S24-DH](#) [VI-M5F-CQ](#) [VI-LN2-EW](#) [VI-PJW01-CZY](#)