



EC7BW18 SERIES 20 WATT 18:1 INPUT ISOLATED DC-DC CONVERTER

Features

- Efficiency up to 90%
- Fixed Switching Frequency
- Regulated Outputs
- Remote On/Off
- Low No Load Power Consumption
- Fully protected (OTP/OCP/OVP/UVLO)
- 3000Vac I/O Isolation
- Operating Case Temperature -40 to +105°C
- 2"x1"x0.4" Size Meet Industrial Standard
- CB Test Certificate IEC62368-1
- EN55032/EN55035/EN50155 Compliant with External Circuits
- UL62368-1 2nd (Reinforce Insulation) Approval
- Shock & Vibration EN50155 (EN61373) Compliant
- Fire & Smoke EN45545-2 Compliant
- 5000m Operating Altitude



MODEL NUMBER	INPUT VOLTAGE	OUTPUT VOLTAGE	OUTPUT CURRENT		INPUT CURRENT		% EFF.		CAPACITOR LOAD MAX.
			MIN.	MAX.	NO LOAD	FULL LOAD	(1)	(2)	
EC7BW18-72S05	8.5-160 VDC	5 VDC	0 mA	4000 mA	5 mA	323 mA	86	85	6800uF
EC7BW18-72S12	8.5-160 VDC	12 VDC	0 mA	1670 mA	8 mA	312 mA	89	88	3300uF
EC7BW18-72S15	8.5-160 VDC	15 VDC	0 mA	1330 mA	8 mA	312 mA	89	88	2200uF
EC7BW18-72D12	8.5-160 VDC	±12 VDC	0 mA	±833 mA	8 mA	312 mA	89	88	820µF
EC7BW18-72D15	8.5-160 VDC	±15 VDC	0 mA	±667 mA	8 mA	312 mA	89	88	680µF
EC7BW18-72D24	8.5-160 VDC	±24 VDC	0 mA	±417 mA	8 mA	309 mA	90	89	330µF

NOTE:

1. Nominal Input Voltage 72 VDC
2. Measured at 110Vin
3. To meet EN50155 and RIA12 refer to application note.

PART NUMBER

Series	Nominal Input Voltage	Number of Outputs	Nominal Output Voltage	Remote On/Off Logic
EC7BW18-	II	O	XX	L
EC7BW18	72: 72 VDC	S: Single D: Dual	05: 5.0VDC 12: 12VDC 15: 15VDC 24: 24VDC	None: Positive N: Negative

Part Number Example:

EC7BW18-72S12N: 2"x1", 20W, 18:1 8.5-160Vdc Input, Single 12Vdc Output, Negative Logic



EC7BW18 Series

TECHNICAL SPECIFICATIONS

(All specifications are typical at nominal input, full load at 25°C unless otherwise noted.)

ABSOLUTE MAXIMUM RATINGS

PARAMETER	NOTES and CONDITIONS	Device	Min.	Typ.	Max.	Units
Input Voltage	Continuous	All	-0.3		160	V _{dc}
Input Surge Voltage	100ms max.	All			200	V _{dc}
Operating Case Temperature	At the center part of case plate	All	-40		105	°C
Storage Temperature		All	-55		125	°C

INPUT CHARACTERISTICS

PARAMETER	NOTES and CONDITIONS	Device	Min.	Typ.	Max.	Units	
Operating Input Voltage		All	8.5	72	160	V _{dc}	
Input Under Voltage Lockout							
Turn-On Voltage Threshold	70% Load	All	8.5	9	9.5	V _{dc}	
Turn-Off Voltage Threshold	70% Load	All	7	7.5	8	V _{dc}	
Lockout Hysteresis Voltage	70% Load	All		1.5		V _{dc}	
Maximum Input Current	V _{in} =12V, Full load	All				2.2	A
	V _{in} =8.5V, 70% Load						
No-Load Input Current	V _{in} =72V, I _o =0A	See Model Number Table				mA	
Input Filter	Pi filter.	All					
Inrush Current (I ² t)	As per ETS300 132-2.	All				0.1	A ² s
Input Reflected Ripple Current	P-P thru 12uH inductor, 5Hz to 20MHz.	All				30	mA

OUTPUT CHARACTERISTICS

PARAMETER	NOTES and CONDITIONS	Device	Min.	Typ.	Max.	Units	
Voltage Set Point Accuracy	V _{in} =72V, Full load, T _c =25°C	All	-1.0		+1.0	%	
Output Voltage Balance	V _{in} =72V, Full load, T _c =25°C	Dual	-1.0		+1.0	%	
Output Voltage Regulation							
Load Regulation	Full load to no load	Single				±0.2	%
		Dual				±1.0	
Line Regulation	V _{in} =High line to low line, full load	All				±0.2	%
Cross Regulation	Load cross variation 25%/100%	Dual				±5.0	%
Temperature Coefficient	T _c =-40°C to 105°C	All				±0.02	%/°C
Output Voltage Ripple and Noise (5Hz to 20MHz bandwidth)							
Peak-to-Peak	Full load, 1.0uF ceramic capacitors.	5Vo				75	mV
RMS.		Others				100	
Output Current Range	V _{in} = 8.5 to 12V	See Power Derating Curve				A	
	V _{in} = 12 to 160V	See Model Number Table					
Over Current Protection	Hiccup Mode. Auto recovery	All	110	150	180	%	
Short Circuit Protection		All	Continuous, Auto Recovery.				
External Load Capacitance	Full load (resistive)	See Model Number Table				uF	
Output Voltage Trim Range	P _o ≤ max rated power, I _o ≤ I _{o,max}	Single	-20		+15	%	
Over Voltage Protection	Zener Clamp	5Vo				6.2	V _{dc}
		12Vo				15	
		15Vo				18	
		±12Vo				±15	
		±15Vo				±18	
		±24Vo				±30	



EC7BW18 Series

EFFICIENCY

PARAMETER	NOTES and CONDITIONS	Device	Min.	Typ.	Max.	Units
100% Load	V _{in} =72V, 110V	See Model Number Table				%

DYNAMIC CHARACTERISTICS

PARAMETER	NOTES and CONDITIONS	Device	Min.	Typ.	Max.	Units
Output Voltage Current Transient						
Error Band	75% to 100% of I _{o_max} step load change d/d _t =0.1A/us (within 1% V _{out} nominal)	All			±5	%
Recovery Time		All			250	us
Turn-On Delay and Rise Time						
Full load (Constant resistive load)						
Turn-On Delay Time, From On/Off Control	V _{on/off} to 10%V _{o_set} , Remote on	All		5		ms
Turn-On Delay Time, From Input	V _{in_min} to 10%V _{o_set} , Power up	All		5		ms
Output Voltage Rise Time	10%V _{o_set} to 90%V _{o_set}	5Vo		10		ms
		Others		5		ms

ISOLATION CHARACTERISTICS

PARAMETER	NOTES and CONDITIONS	Device	Min.	Typ.	Max.	Units
Isolation Voltage (100% factory Hi-Pot tested @2sec.)	1 minute; Input to output,	All			3000	V _{ac}
					4200	V _{dc}
Isolation Resistance	Input to output	All	1000			MΩ
Isolation Capacitance	Input to output (10KHz, 0.25V)	All		20		pF

FEATURE CHARACTERISTICS

PARAMETER	NOTES and CONDITIONS	Device	Min.	Typ.	Max.	Units
Switching Frequency	Output ripple frequency	All	180	200	220	KHz
On/Off Control, Positive Remote On/Off logic, Refer to -Vin pin.						
Logic Low (Module Off)	V _{on/off} at I _{on/off} =1.0mA	All	0		1.2	V
Logic High (Module On)	V _{on/off} at I _{on/off} =0.0uA, Pin open=On	All	4.0 or Open Circuit		160	V
On/Off Control, Negative Remote On/Off logic, Refer to -Vin pin						
Logic High (Module Off)	V _{on/off} at I _{on/off} =0.0uA, Pin open=Off	All	4.0 or Open Circuit		160	V
Logic Low (Module On)	V _{on/off} at I _{on/off} =1.0mA	All	0		1.2	V
On/Off Current (for both remote on/off logic)	I _{on/off} at V _{on/off} =0V	All		0.4	1	mA
Leakage Current (for both remote on/off logic)	Logic High, V _{on/off} =15V	All			30	uA
Off Converter Input Current	Shutdown input idle current	All		3	5	mA
Over Temperature Shutdown	Temperature at the center part of case, non-latching	All		110		°C
Over Temperature Recovery		All		92		°C

GENERAL SPECIFICATIONS

PARAMETER	NOTES and CONDITIONS	Device	Min.	Typ.	Max.	Units
MTBF	I _o =100% of I _{o_max} ; MIL-HDBK - 217F_Notice 1, GB, 25°C	5Vo		1242		K hours
		12Vo		1397		
		15Vo		1631		
		±12Vo		1341		
		±15Vo		1571		
		±24Vo		1622		
Weight		All		28.5		grams
Case Material	Plastic, DAP, UL 94V-0					
Base plate Material	FR4					



EC7BW18 Series

GENERAL SPECIFICATIONS

Potting Material	UL 94V-0		
Pin Material	Base: Copper Plating: Nickel with Matte Tin		
Shock/Vibration	MIL-STD-810F/EN61373 Compliant		
Humidity	95% RH max. Non Condensing		
Altitude	5000m Operating Altitude, 12000m Transport Altitude		
Thermal Shock	MIL-STD-810F		
Fire & Smoke	EN45545-2 Compliant		
EMI	Meets EN55032 & EN50155 Compliant (with external filter)		Class A
ESD	EN61000-4-2	Level 3: Air $\pm 8kV$, Contact $\pm 6kV$	Perf. Criteria A
Radiated immunity	EN61000-4-3	Level 3: 80~1000MHz, 20V/m	Perf. Criteria A
Fast Transient	EN61000-4-4	Level 3: On power input port, $\pm 2kV$, external input capacitor required (EN50155) Level 4: On power input port, $\pm 4kV$, external input capacitor required (EN55035)	Perf. Criteria A
Surge	EN61000-4-5	Level 4: Line to earth, $\pm 4kV$, Line to line, $\pm 2kV$ (EN50155) Level 4: Line to earth, $\pm 4kV$, Line to line, $\pm 2kV$ (EN55035)	Perf. Criteria A
Conducted immunity	EN61000-4-6	Level 3: 0.15~80MHz, 10V	Perf. Criteria A
Interruptions of Voltage Supply	EN50155	Class S3: 20ms interruptions	Perf. Criteria A
Supply Change Over	EN50155	Class C2: During a supply break of 30 ms	Perf. Criteria A
Application Note Link	EC7BW18-72S Series App Notes		
Packaging Information Link	Packaging Information		

Immunity to Environmental Conditions

Phenomenon	EN50155; 2017 Reference Clause(s)	Reference Standard	Test Conditions	Result
Low Temperature Start-up test	13.4.4	EN 60068-2-1	Class OT4 Temperature: $-40^{\circ}C$ Duration: 2 hrs	Pass
Dry Heat Test	13.4.5	EN 60068-2-2	Class OT4 & ST2 Temperature: $70^{\circ}C$ Duration: 6 hrs Extended temperature: $85^{\circ}C$ Extended Duration: 10min	Pass
Low Temperature Storage Test	13.4.6	EN 60068-2-1	Temperature: $-40^{\circ}C$ Duration: 16 hrs	Pass
Cyclic Damp Heat Test	13.4.7	EN 60068-2-30	Temperature: $25^{\circ}C - 55^{\circ}C$ Humidity: 90% RH Duration: 48 hrs	Pass
Random Vibration Test	13.4.11	EN 61373	Temperature: $25^{\circ}C \pm 10^{\circ}C$ Humidity: 50% $\pm 25\%$ RH Frequency range: 5 ~ 150 Hz Vertical: $1.01 m/s^2$ Transverse: $0.450 m/s^2$ Longitudinal: $0.700 m/s^2$ Duration: 10 min / axis	Pass
Simulated Long Life Test at Increased Random Vibration Levels	13.4.11	EN 61373	Temperature: $25^{\circ}C \pm 10^{\circ}C$ Humidity: 50% $\pm 25\%$ RH Frequency range: 5 ~ 150 Hz Vertical: $5.72 m/s^2$ Transverse: $2.55 m/s^2$ Longitudinal: $3.96 m/s^2$ Duration: 5 hrs / axis	Pass
Shock Test	13.4.11	EN 61373	Temperature: $25^{\circ}C \pm 10^{\circ}C$ Humidity: 50% $\pm 25\%$ RH Frequency range: 5 ~ 150 Hz \pm -Vertical: $30 m/s^2$ \pm -Transverse: $30 m/s^2$ \pm -Longitudinal: $50 m/s^2$ Duration: 30ms x18 (Each axis 3 shocks)	Pass



EC7BW18 Series

EN45545-2 Fire & Smoke Test Conditions

Item		Standard	Hazard Level
R22	Oxygen Index Test	EN 45545-2: 2013 EN ISO 4589-2: 2006	HL1, HL2, HL3
	Smoke Density Test	EN 45545-2: 2013 EN ISO 5659-2: 2013	HL1, HL2, HL3
	Smoke Toxicity Test	EN 45545-2: 2013 NF X70-100: 2006	HL1, HL2, HL3
R23	Oxygen Index Test	EN 45545-2: 2013 EN ISO 4589-2: 2006	HL1, HL2, HL3
	Smoke Density Test	EN 45545-2: 2013 EN ISO 5659-2: 2013	HL1, HL2, HL3
	Smoke Toxicity Test	EN 45545-2: 2013 NF X70-100: 2006	HL1, HL2, HL3
R24	Oxygen Index Test	EN45545-2: 2013 EN ISO 4589-2	HL1, HL2, HL3
R25	Glow - Wire Test	EN 45545-2:2013 EN 60695-2-11:2001	HL1, HL2, HL3
R26	Vertical Flame Test	EN 45545-2: 2013 EN 60695-11-10: 2013	HL1, HL2, HL3

CHARACTERISTIC CURVE

Power Derating Curve

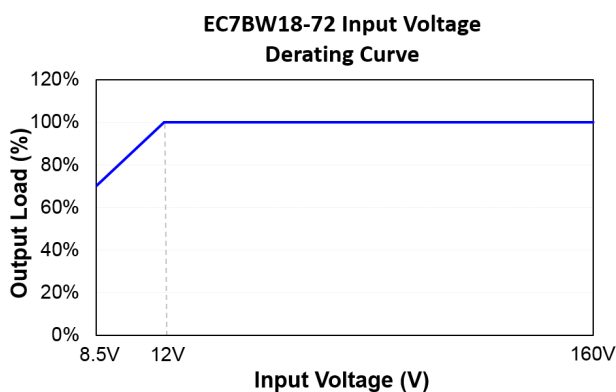
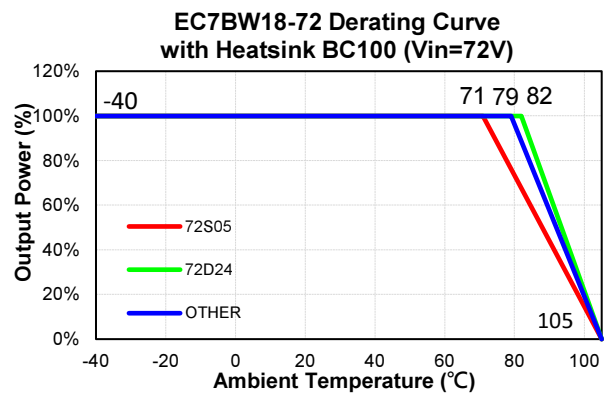
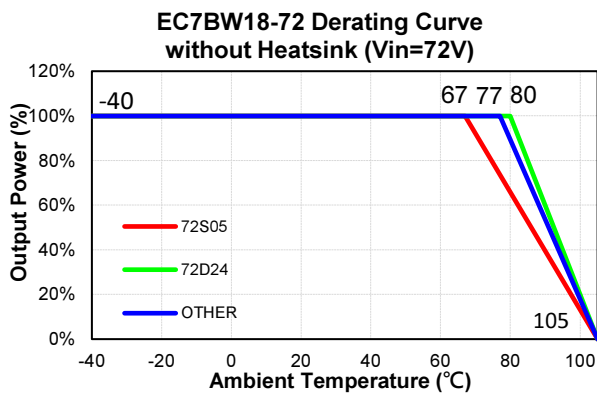



EC7BW18 Series

Performance Data

EC7BW18-72S05
Eff Vs Io @25 Deg. C

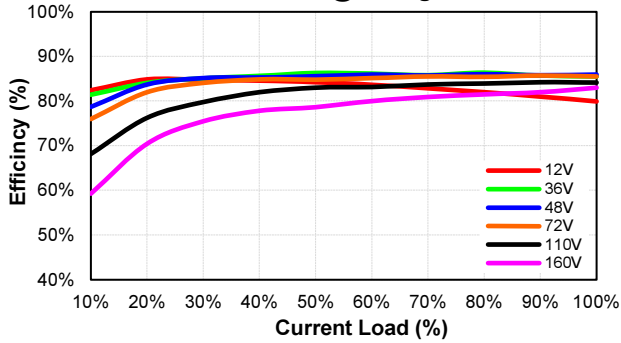

EC7BW18-72S05
Pd Vs Po @25 Deg. C

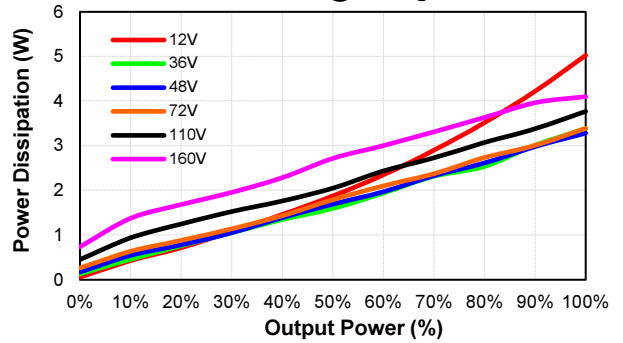

EC7BW18-72S12
Eff Vs Io @25 Deg. C

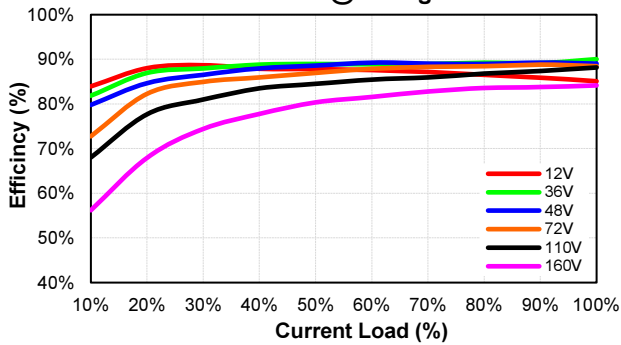

EC7BW18-72S12
Pd Vs Po @25 Deg. C

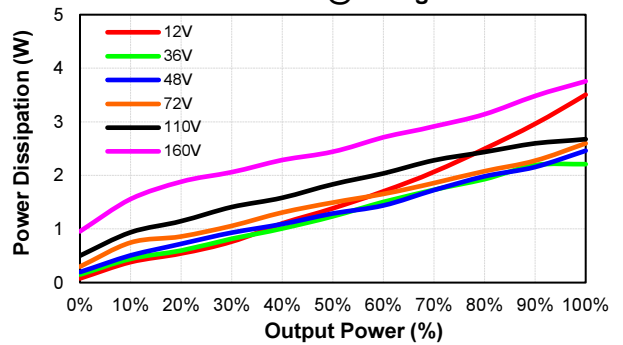

EC7BW18-72S15
Eff Vs Io @25 Deg. C

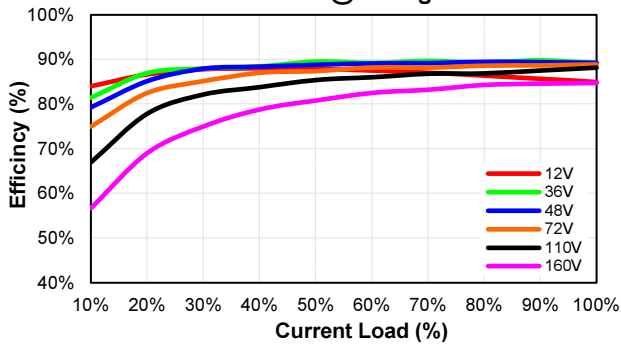

EC7BW18-72S15
Pd Vs Po @25 Deg. C

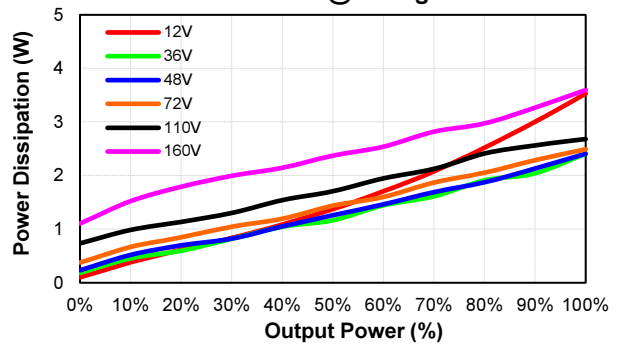

EC7BW18-72D12
Eff Vs Io @25 Deg. C

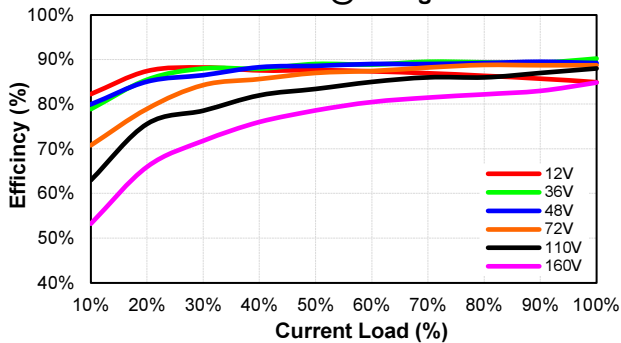

EC7BW18-72D12
Pd Vs Po @25 Deg. C

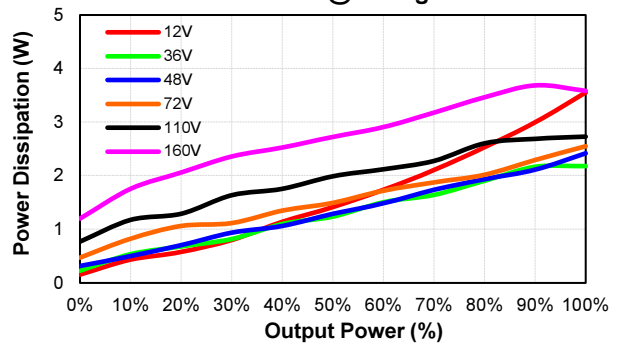



EC7BW18 Series

EC7BW18-72D15
Eff Vs Io @25 Deg. C

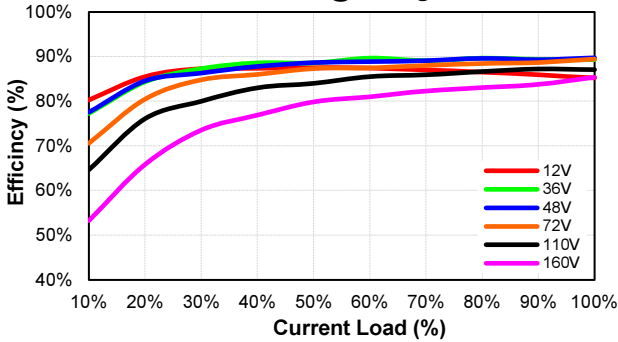

EC7BW18-72D15
Pd Vs Po @25 Deg. C

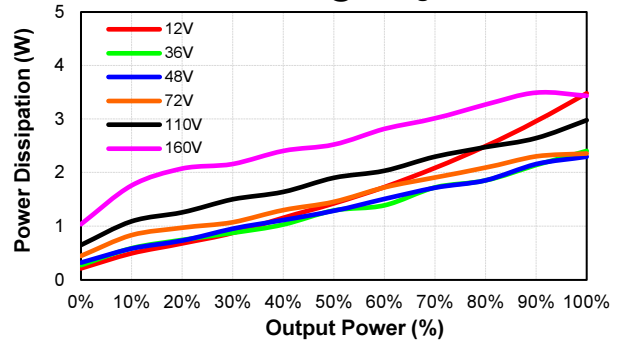

EC7BW18-72D24
Eff Vs Io @25 Deg. C

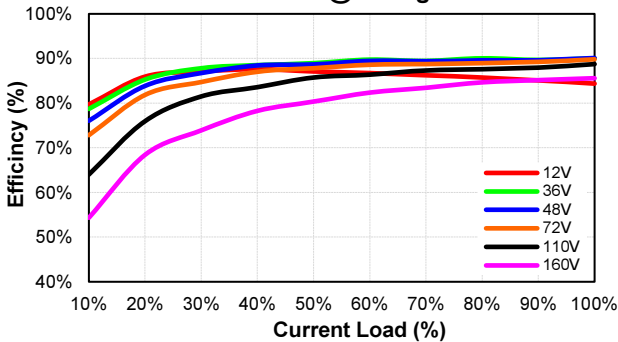

EC7BW18-72D24
Pd Vs Po @25 Deg. C

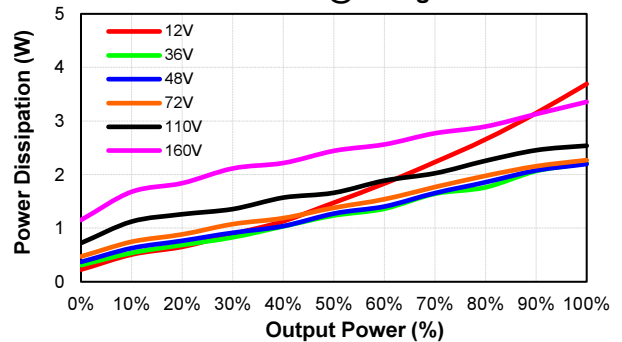

EC7BW18-72S05
Eff Vs Io @25 Deg. C

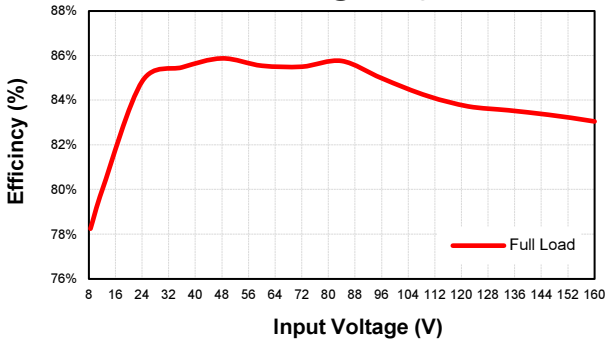

EC7BW18-72S12
Eff Vs Io @25 Deg. C

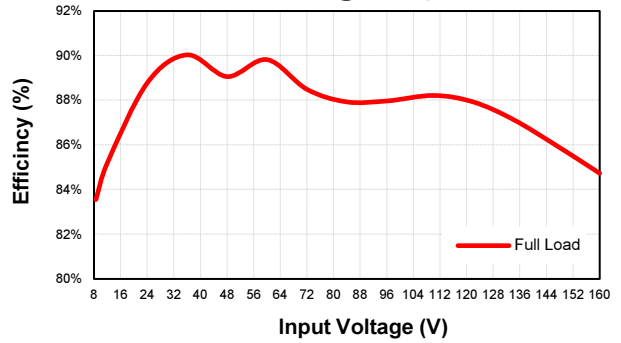

EC7BW18-72S15
Eff Vs Io @25 Deg. C

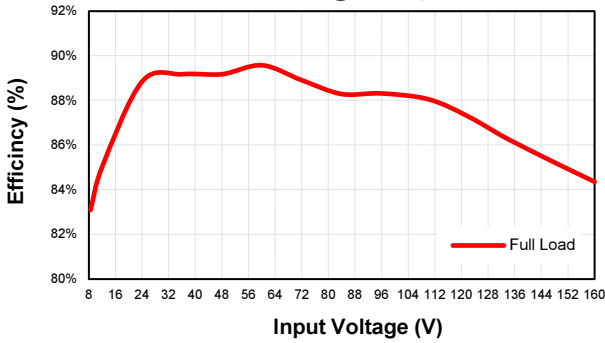

EC7BW18-72D12
Eff Vs Io @25 Deg. C

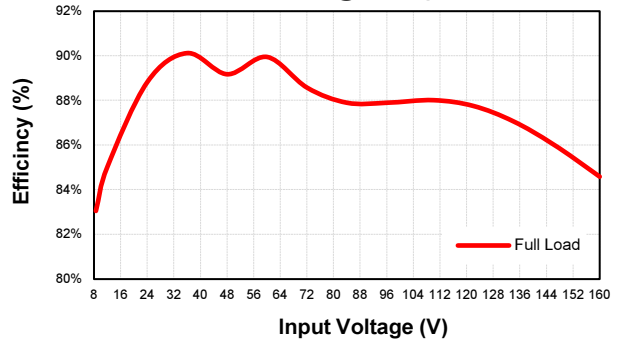



EC7BW18 Series

EC7BW18-72D15
Eff Vs Io @25 Deg. C

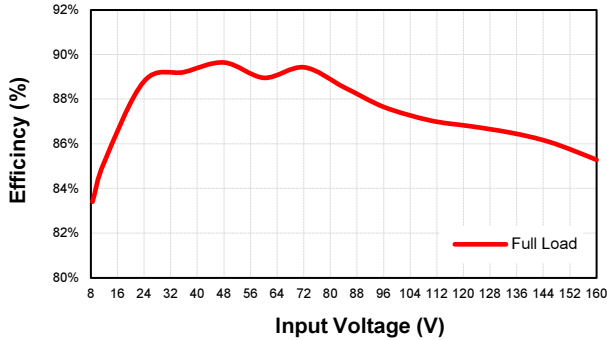

EC7BW18-72D24
Eff Vs Io @25 Deg. C

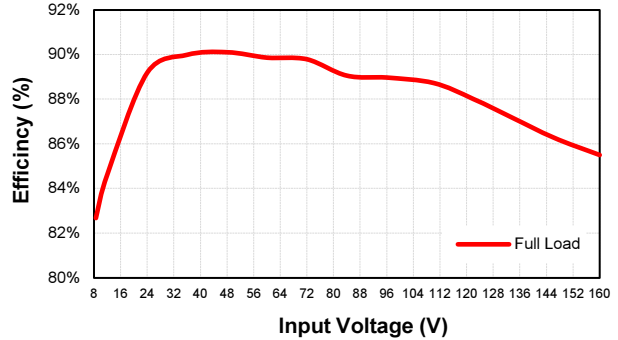

Note: 8.5Vin Efficiency at 70% Full Load

MECHANICAL SPECIFICATION

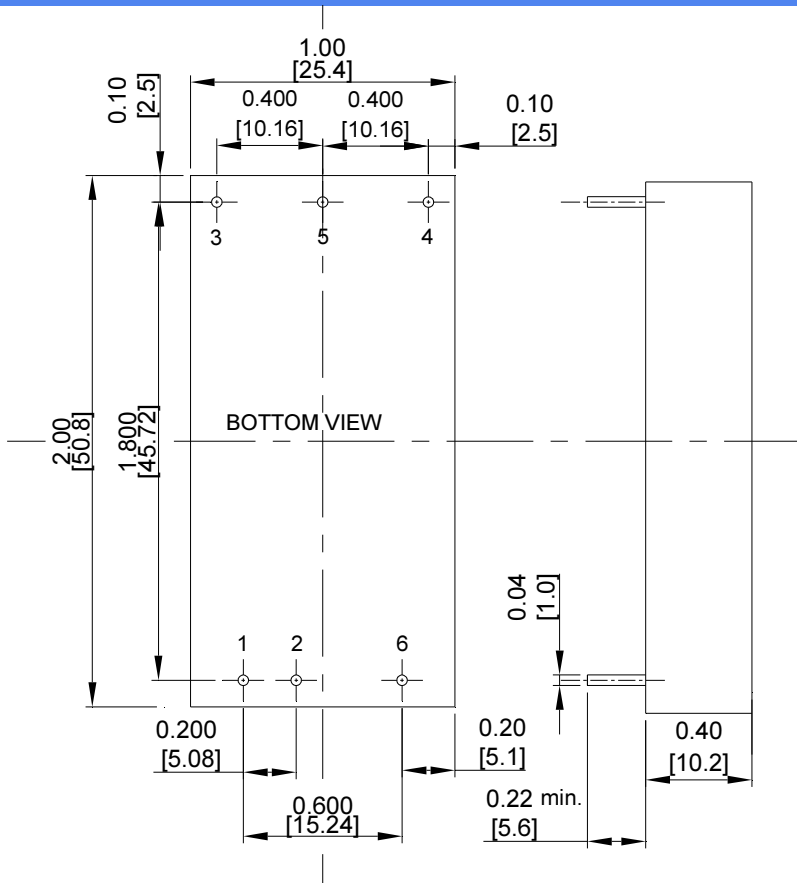

PIN CONNECTION		
Pin	Single	Dual
1	+V Input	+V Input
2	-V Input	-V Input
3	+V Output	+V Output
4	Trim	-V Output
5	-V Output	Common
6	Remote On/Off	

NOTE: Pin Size is 0.04±0.004 Inch (1.0±0.1 mm)DIA
All Dimensions In Inches (mm)
Tolerances Inches: X.XX= ±0.02 , X.XXX= ±0.010
Millimeters: X.X= ±0.5, X.XX= ±0.25

CINCON Electronics Co. Ltd.
Add: 14F, No. 306, Sec.4, Hsin Yi Rd., Taipei, Taiwan
Tel: 886-2-27086210
Fax: 886-2-27029852
E-mail: sales@cincon.com.tw
Web: www.cincon.com

X-ON Electronics

Largest Supplier of Electrical and Electronic Components

Click to view similar products for [Isolated DC/DC Converters](#) category:

Click to view products by [Cincon](#) manufacturer:

Other Similar products are found below :

[ESM6D044440C05AAQ](#) [FMD15.24G](#) [PSL486-7LR](#) [Q48T30020-NBB0](#) [JAHW100Y1](#) [SPB05C-12](#) [SQ24S15033-PS0S](#) [18952](#) [19-130041](#)
[CE-1003](#) [CE-1004](#) [GQ2541-7R](#) [RDS180245](#) [MAU228](#) [J80-0041NL](#) [DFC15U48D15](#) [XGS-0512](#) [XGS-1205](#) [XGS-1212](#) [XGS-2412](#) [XGS-2415](#) [XKS-1215](#) [06322](#) [NCT1000N040R050B](#) [SPB05B-15](#) [SPB05C-15](#) [L-DA20](#) [DCG40-5G](#) [QME48T40033-PGB0](#) [XKS-2415](#) [XKS-2412](#)
[XKS-1212](#) [XKS-1205](#) [XKS-0515](#) [XKS-0505](#) [XGS-2405](#) [XGS-1215](#) [XGS-0515](#) [PS9Z-6RM4](#) [73-551-5038I](#) [AK1601-9RT](#) [VI-N61-CM](#) [VI-R5022-EXWW](#) [PSC128-7iR](#) [RPS8-350ATX-XE](#) [DAS1004812](#) [PQA30-D24-S24-DH](#) [VI-M5F-CQ](#) [VI-LN2-EW](#) [VI-PJW01-CZY](#)