

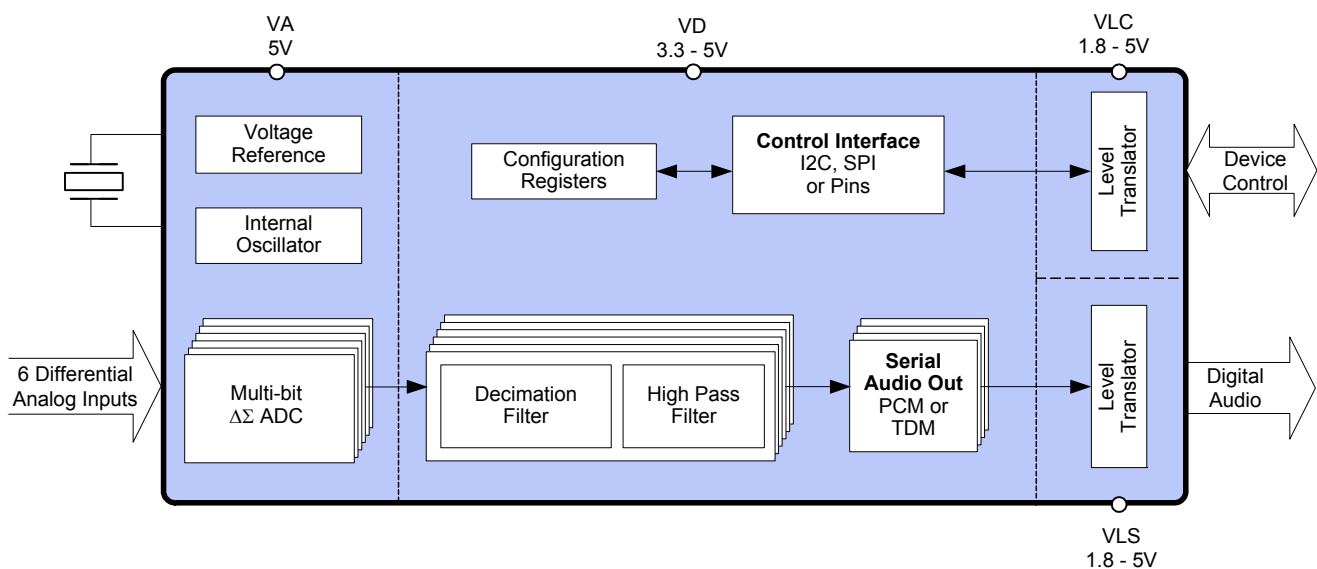
## 114 dB, 192 kHz, 6-Channel A/D Converter

### Features

- ◆ Advanced Multi-bit Delta-Sigma Architecture
- ◆ 24-Bit Conversion
- ◆ 114 dB Dynamic Range
- ◆ -105 dB THD+N
- ◆ Supports Audio Sample Rates up to 216 kHz
- ◆ Selectable Audio Interface Formats
  - Left-Justified, I<sup>2</sup>S, TDM
  - 6-Channel TDM Interface Formats
- ◆ Low Latency Digital Filter
- ◆ Less than 535 mW Power Consumption
- ◆ On-Chip Oscillator Driver
- ◆ Operation as System Clock Master or Slave
- ◆ Auto-Detect Speed in Slave Mode
- ◆ Differential Analog Architecture
- ◆ Separate 1.8 V to 5 V Logic Supplies for Control and Serial Ports
- ◆ High-Pass Filter for DC Offset Calibration
- ◆ Overflow Detection
- ◆ Footprint Compatible with the 8-Channel CS5368

### Additional Control Port Features

- ◆ Supports I<sup>2</sup>C or SPI™ Control Interface per specifications on [page 17](#) and [page 18](#)
- ◆ Individual Channel HPF Disable
- ◆ Overflow Detection for Individual Channels
- ◆ Mute Control for Individual Channels
- ◆ Independent Power-Down Control per Channel Pair



## Description

The CS5366 is a complete 6-channel analog-to-digital converter for digital audio systems. It performs sampling, analog-to-digital conversion, and anti-alias filtering, generating 24-bit values for all 6-channel inputs in serial form at sample rates up to 216 kHz per channel.

The CS5366 uses a 5th-order, multi-bit delta sigma modulator followed by low latency digital filtering and decimation, which removes the need for an external anti-aliasing filter. The ADC uses a differential input architecture which provides excellent noise rejection.

Dedicated level translators for the Serial Port and Control Port allow seamless interfacing between the CS5366 and other devices operating over a wide range of logic levels. In addition, an on-chip oscillator driver provides clocking flexibility and simplifies design.

The CS5366 is the industry's first audio A/D to support a high-speed TDM interface which provides a serial output of 6 channels of audio data with sample rates up to 216 kHz within a single data stream. It further reduces layout complexity and relieves input/output constraints in digital signal processors.

The CS5366 is available in a [48-pin LQFP](#) package in both Commercial (-40°C to 85°C) and Automotive grades (-40°C to +105°C). The CDB5366 Customer Demonstration board is also available for device evaluation and implementation suggestions. Please see ["Ordering Information" on page 41](#) for complete ordering information.

The CS5366 is ideal for high-end and pro-audio systems requiring unrivaled sound quality, transparent conversion, wide dynamic range and negligible distortion, such as A/V receivers, digital mixing consoles, multi-channel recorders, outboard converters, digital effect processors, and automotive audio systems.

---

**TABLE OF CONTENTS**

<b>1. PIN DESCRIPTION .....</b>	<b>6</b>
<b>2. TYPICAL CONNECTION DIAGRAM .....</b>	<b>9</b>
<b>3. CHARACTERISTICS AND SPECIFICATIONS .....</b>	<b>10</b>
RECOMMENDED OPERATING CONDITIONS .....	10
ABSOLUTE RATINGS .....	10
SYSTEM CLOCKING .....	10
DC POWER .....	11
LOGIC LEVELS .....	11
PSRR, VQ AND FILT+ CHARACTERISTICS .....	11
ANALOG CHARACTERISTICS (COMMERCIAL) .....	12
ANALOG PERFORMANCE (AUTOMOTIVE) .....	13
DIGITAL FILTER CHARACTERISTICS .....	14
OVERFLOW TIMEOUT .....	14
SERIAL AUDIO INTERFACE - I <sup>2</sup> S/LJ TIMING .....	15
SERIAL AUDIO INTERFACE - TDM TIMING .....	16
SWITCHING SPECIFICATIONS - CONTROL PORT - I <sup>2</sup> C TIMING .....	17
SWITCHING SPECIFICATIONS - CONTROL PORT - SPI TIMING .....	18
<b>4. APPLICATIONS .....</b>	<b>19</b>
4.1 Power .....	19
4.2 Control Port Mode and Stand-Alone Operation .....	19
4.2.1 Stand-Alone Mode .....	19
4.2.2 Control Port Mode .....	19
4.3 Master Clock Source .....	20
4.3.1 On-Chip Crystal Oscillator Driver .....	20
4.3.2 Externally Generated Master Clock .....	20
4.4 Master and Slave Operation .....	21
4.4.1 Synchronization of Multiple Devices .....	21
4.5 Serial Audio Interface (SAI) Format .....	22
4.5.1 I <sup>2</sup> S and LJ Format .....	22
4.5.2 TDM Format .....	23
4.5.3 Configuring Serial Audio Interface Format .....	23
4.6 Speed Modes .....	23
4.6.1 Sample Rate Ranges .....	23
4.6.2 Using M1 and M0 to Set Sampling Parameters .....	23
4.6.3 Master Mode Clock Dividers .....	24
4.6.4 Slave Mode Audio Clocking With Auto-Detect .....	24
4.7 Master and Slave Clock Frequencies .....	25
4.8 Reset .....	27
4.8.1 Power-Down Mode .....	27
4.9 Overflow Detection .....	27
4.9.1 Overflow in Stand-Alone Mode .....	27
4.9.2 Overflow in Control Port Mode .....	27
4.10 Analog Connections .....	28
4.11 Optimizing Performance in TDM Mode .....	29
4.12 DC Offset Control .....	29
4.13 Control Port Operation .....	30
4.13.1 SPI Mode .....	30
4.13.2 I <sup>2</sup> C Mode .....	31
<b>5. REGISTER MAP .....</b>	<b>32</b>
5.1 Register Quick Reference .....	32
5.2 00h (REVI) Chip ID Code & Revision Register .....	32

5.3 01h (GCTL) Global Mode Control Register .....	32
5.4 02h (OVFL) Overflow Status Register .....	33
5.5 03h (OVFM) Overflow Mask Register .....	33
5.6 04h (HPF) High-Pass Filter Register .....	34
5.7 05h Reserved .....	34
5.8 06h (PDN) Power Down Register .....	34
5.9 07h Reserved .....	34
5.10 08h (MUTE) Mute Control Register .....	34
5.11 09h Reserved .....	35
5.12 0Ah (SDEN) SDOOUT Enable Control Register .....	35
<b>6. FILTER PLOTS .....</b>	<b>36</b>
<b>7. PARAMETER DEFINITIONS .....</b>	<b>39</b>
<b>8. PACKAGE DIMENSIONS .....</b>	<b>40</b>
THERMAL CHARACTERISTICS .....	40
<b>9. ORDERING INFORMATION .....</b>	<b>41</b>
<b>10. REVISION HISTORY .....</b>	<b>41</b>

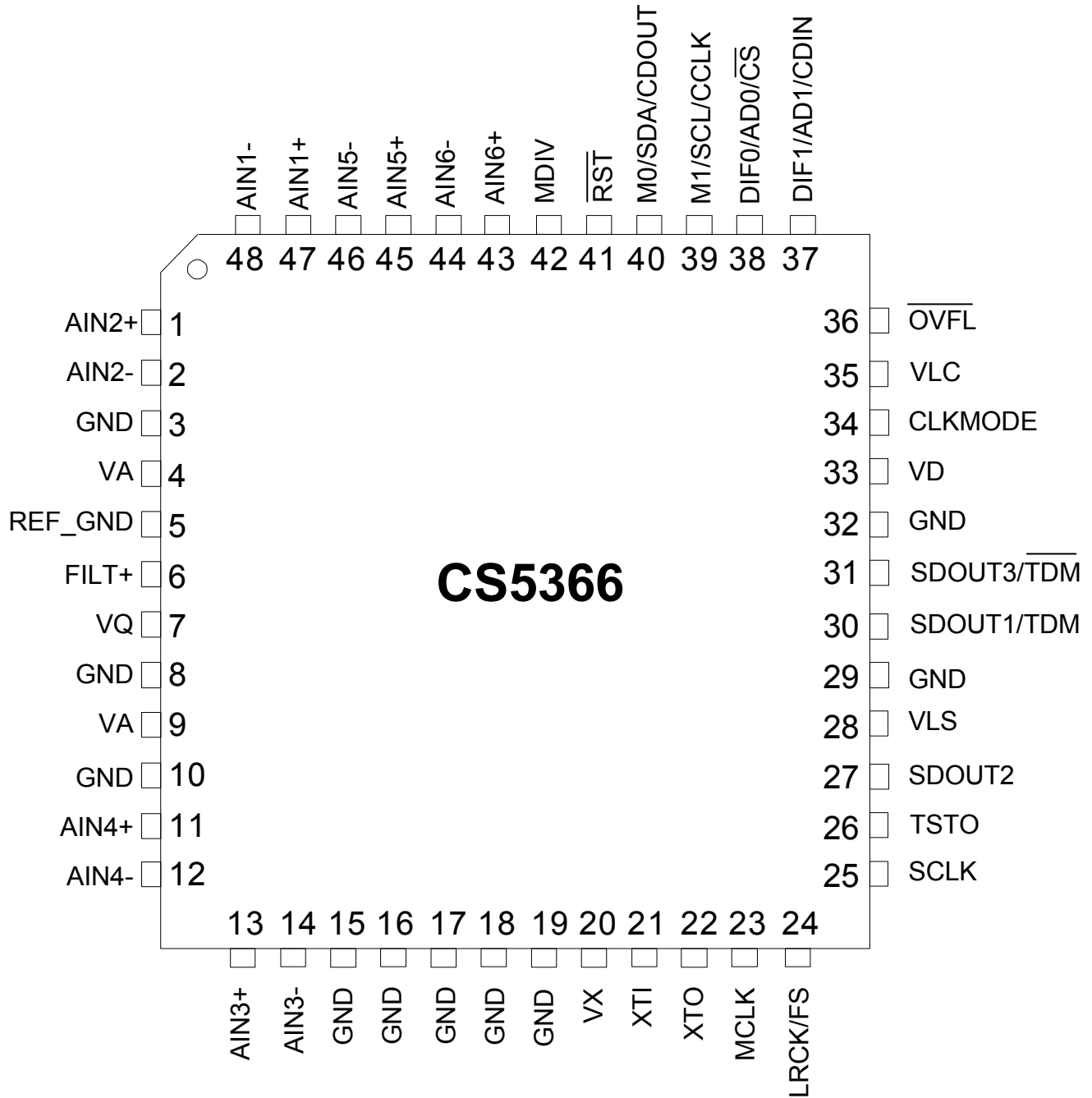
## LIST OF FIGURES

Figure 1. CS5366 Pinout .....	6
Figure 2. Typical Connection Diagram .....	9
Figure 3. I <sup>2</sup> S/LJ Timing .....	15
Figure 4. TDM Timing .....	16
Figure 5. I <sup>2</sup> C Timing .....	17
Figure 6. SPI Timing .....	18
Figure 7. Crystal Oscillator Topology .....	20
Figure 8. Master/Slave Clock Flow .....	21
Figure 9. Master and Slave Clocking for a Multi-Channel Application .....	21
Figure 10. I <sup>2</sup> S Format .....	22
Figure 11. LJ Format .....	22
Figure 12. TDM Format .....	23
Figure 13. Master Mode Clock Dividers .....	24
Figure 14. Slave Mode Auto-Detect Speed .....	24
Figure 15. Recommended Analog Input Buffer .....	28
Figure 16. SPI Format .....	30
Figure 17. I <sup>2</sup> C Write Format .....	31
Figure 18. I <sup>2</sup> C Read Format .....	31
Figure 19. SSM Passband .....	36
Figure 20. DSM Passband .....	36
Figure 21. QSM Passband .....	36
Figure 22. SSM Stopband .....	37
Figure 23. DSM Stopband .....	37
Figure 24. QSM Stopband .....	37
Figure 25. SSM -1 dB Cutoff .....	38
Figure 26. DSM -1 dB Cutoff .....	38
Figure 27. QSM -1 dB Cutoff .....	38

---

**LIST OF TABLES**

Table 1. Power Supply Pin Definitions .....	19
Table 2. DIF1 and DIF0 Pin Settings .....	23
Table 3. M1 and M0 Settings .....	23
Table 4. Frequencies for 48 kHz Sample Rate using LJ/I <sup>2</sup> S .....	25
Table 5. Frequencies for 96 kHz Sample Rate using LJ/I <sup>2</sup> S .....	25
Table 6. Frequencies for 192 kHz Sample Rate using LJ/I <sup>2</sup> S .....	25
Table 7. Frequencies for 48 kHz Sample Rate using TDM .....	25
Table 8. Frequencies for 48 kHz Sample Rate using TDM .....	25
Table 9. Frequencies for 96 kHz Sample Rate using TDM .....	26
Table 10. Frequencies for 96 kHz Sample Rate using TDM .....	26
Table 11. Frequencies for 192 kHz Sample Rate using TDM .....	26
Table 12. Frequencies for 192 kHz Sample Rate using TDM .....	26

**1. PIN DESCRIPTION**

**Figure 1. CS5366 Pinout**

Pin Name	Pin #	Pin Description
AIN2+, AIN2- AIN4+, AIN4- AIN3+, AIN3- AIN6+, AIN6- AIN5+, AIN5- AIN1+, AIN1-	1,2 11,12 13,14 43,44 45,46 47,48	<b>Differential Analog (Inputs)</b> - Audio signals are presented differently to the delta sigma modulators via the AIN+/- pins.
GND	3,8 10,15 16,17 18,19 29,32	<b>Ground (Input)</b> - Ground reference. Must be connected to analog ground.
VA	4,9	<b>Analog Power (Input)</b> - Positive power supply for the analog section
REF_GND	5	<b>Reference Ground (Input)</b> - For the internal sampling circuits. Must be connected to analog ground.
FILT+	6	<b>Positive Voltage Reference (Output)</b> - Reference voltage for internal sampling circuits.
VQ	7	<b>Quiescent Voltage (Output)</b> - Filter connection for the internal quiescent reference voltage.
VX	20	<b>Crystal Oscillator Power (Input)</b> - Also powers control logic to enable or disable oscillator circuits.
XTI XTO	21 22	<b>Crystal Oscillator Connections (Input/Output)</b> - I/O pins for an external crystal which may be used to generate MCLK.
MCLK	23	<b>System Master Clock (Input/Output)</b> - When a crystal is used, this pin acts as a buffered MCLK Source (Output). When the oscillator function is not used, this pin acts as an input for the system master clock. In this case, the XTI and XTO pins must be tied low.
LRCK/FS	24	<b>Serial Audio Channel Clock (Input/Output)</b> In I <sup>2</sup> S mode Serial Audio Channel Select. When low, the odd channels are selected. In LJ mode Serial Audio Channel Select. When high, the odd channels are selected. In TDM Mode a frame sync signal. When high, it marks the beginning of a new frame of serial audio samples. In Slave Mode, this pin acts as an input pin.
SCLK	25	<b>Main timing clock for the Serial Audio Interface (Input/Output)</b> - During Master Mode, this pin acts as an output, and during Slave Mode it acts as an input pin.
TSTO	26	<b>Test Out (Output)</b> - Must be left unconnected.
SDOUT2	27	<b>Serial Audio Data (Output)</b> - Channels 3,4
VLS	28	<b>Serial Audio Interface Power</b> - Positive power for the serial audio interface.
SDOUT1/TDM	30	<b>Serial Audio Data (Output)</b> - Channels 1,2, TDM.
SDOUT3/ $\overline{\text{TDM}}$	31	<b>Serial Audio Data (Output)</b> - Channels 5,6, $\overline{\text{TDM}}$ is complementary TDM data.
VD	33	<b>Digital Power (Input)</b> - Positive power supply for the digital section.
VLC	35	<b>Control Port Interface Power</b> - Positive power for the control port interface.
$\overline{\text{OVFL}}$	36	<b>Overflow (Output, open drain)</b> - Detects an overflow condition on both left and right channels.
$\overline{\text{RST}}$	41	<b>Reset (Input)</b> - The device enters a low power mode when low.
<b>Stand-Alone Mode</b>		
CLKMODE	34	<b>CLKMODE (Input)</b> - Setting this pin HIGH places a divide-by-1.5 circuit in the MCLK path to the core device circuitry.
DIF1 DIF0	37 38	<b>DIF1, DIF0 (Input)</b> - Sets the serial audio interface format.
M1 M0	39 40	<b>Mode Selection (Input)</b> - Determines the operational mode of the device.
MDIV	42	<b>MCLK Divider (Input)</b> - Setting this pin HIGH places a divide-by-2 circuit in the MCLK path to the core device circuitry.

<b>Control Port Mode</b>		
CLKMODE	34	<b>CLKMODE</b> ( <i>Input</i> ) - This pin is ignored in Control Port Mode and the same functionality is obtained from the corresponding bit in the Global Control Register. <b>Note:</b> Should be connected to GND when using the part in Control Port Mode.
AD1/CDIN	37	<b>I<sup>2</sup>C Format, AD1</b> ( <i>Input</i> ) - Forms the device address input AD[1]. <b>SPI Format, CDIN</b> ( <i>Input</i> ) - Becomes the input data pin.
AD0/ $\overline{\text{CS}}$	38	<b>I<sup>2</sup>C Format, AD0</b> ( <i>Input</i> ) - Forms the device address input AD[0]. <b>SPI Format, CS</b> ( <i>Input</i> ) - Acts as the active low chip select input.
SCL/CCLK	39	<b>I<sup>2</sup>C Format, SCL</b> ( <i>Input</i> ) - Serial clock for the serial control port. An external pull-up resistor is required for I <sup>2</sup> C control port operation. <b>SPI Format, CCLK</b> ( <i>Input</i> ) - Serial clock for the serial control port.
SDA/CDOUT	40	<b>I<sup>2</sup>C Format SDA</b> ( <i>Input/Output</i> ) - Acts as an input/output data pin. An external pull-up resistor is required for I <sup>2</sup> C control port operation. <b>SPI Format CDOUT</b> ( <i>Output</i> ) - Acts as an output only data pin.
MDIV	42	<b>MCLK Divider</b> ( <i>Input</i> ) - This pin is ignored in Control Port Mode and the same functionality is obtained from the corresponding bit in the Global Control Register. <b>Note:</b> Should be connected to GND when using the part in Control Port Mode.





### 3. CHARACTERISTICS AND SPECIFICATIONS

#### RECOMMENDED OPERATING CONDITIONS

GND = 0 V, all voltages with respect to 0 V.

Parameter	Symbol	Min	Typ	Max	Unit	
DC Power Supplies:	Positive Analog	VA	4.75	5.0	5.25	V
	Positive Crystal	VX	4.75	5.0		
	Positive Digital	VD	3.14	3.3		
	Positive Serial Logic	VLS	1.71 <sup>1</sup>	3.3		
	Positive Control Logic	VLC	1.71	3.3		
Ambient Operating Temperature	(-CQZ)	T <sub>AC</sub>	-40	-	85	°C
	(-DQZ)	T <sub>AA</sub>	-40	-	105	

1. TDM Quad-Speed Mode specified to operate correctly at VLS ≥ 3.14 V.

#### ABSOLUTE RATINGS

Operation beyond these limits may result in permanent damage to the device. Normal operation is not guaranteed at these extremes. Transient currents up to ±100 mA on the analog input pins will not cause SCR latch-up.

Parameter	Symbol	Min	Typ	Max	Units	
DC Power Supplies:	Positive Analog	VA	-0.3	-	+6.0	V
	Positive Crystal	VX				
	Positive Digital	VD				
	Positive Serial Logic	VLS				
	Positive Control Logic	VLC				
Input Current	I <sub>in</sub>	-10	-	+10	mA	
Analog Input Voltage	V <sub>IN</sub>	-0.3		VA+0.3	V	
Digital Input Voltage	V <sub>IND</sub>			VL+0.3		
Ambient Operating Temperature (Power Applied)	T <sub>A</sub>	-50		+125	°C	
Storage Temperature	T <sub>stg</sub>	-65		+150		

#### SYSTEM CLOCKING

Parameter	Symbol	Min	Typ	Max	Unit
Input Master Clock Frequency	MCLK	0.512		55.05	MHz
Input Master Clock Duty Cycle	t <sub>clkhl</sub>	40		60	%

## DC POWER

MCLK = 12.288 MHz; Master Mode. GND = 0 V.

Parameter	Symbol	Min	Typ	Max	Unit	
Power Supply Current (Normal Operation)	VA = 5 V	IA	-	76	84	mA
	VX = 5 V	IX	-	4	8	mA
	VD = 5 V	ID	-	60	66	mA
	VD = 3.3 V	ID	-	37	40	mA
	VLS, VLC = 5 V	IL	-	6	8	mA
	VLS, VLC = 3.3 V	IL	-	3	5	mA
Power Supply Current (Power-Down) (Note 1)	VA = 5 V	IA	-	50	-	μA
	VLS, VLC, VD = 5 V	ID	-	500	-	μA
Power Consumption (Normal Operation)	All Supplies = 5 V	-	-	730	830	mW
	VA = 5 V, VD = VLS = VLC = 3.3 V	-	-	532	609	mW
	(Power-Down) (Note 1)	-	-	2.75	-	mW

1. Power-Down is defined as  $\overline{\text{RST}} = \text{LOW}$  with all clocks and data lines held static at a valid logic level.

## LOGIC LEVELS

Parameter	Symbol	Min	Typ	Max	Units	
High-Level Input Voltage	%VLS/VLC	VIH	70	-	%	
Low-Level Input Voltage	%VLS/VLC	VIL	-	-	30	%
High-Level Output Voltage at 100 μA load	%VLS/VLC	VOH	85	-	-	%
Low-Level Output Voltage at -100 μA load	%VLS/VLC	VOL	-	-	15	%
SDA Low-Level Output Voltage at -2 mA load	%VLC	VOL	-	-	TBD	%
OVFL Current Sink			-4		mA	
Input Leakage Current	logic pins only	Iin	-10	-	10	μA

## PSRR, VQ AND FILT+ CHARACTERISTICS

MCLK = 12.288 MHz; Master Mode. Valid with the recommended capacitor values on FILT+ and VQ as shown in the "Typical Connection Diagram".

Parameter	Symbol	Min	Typ	Max	Unit
Power Supply Rejection Ratio at (1 kHz)	PSRR	-	65	-	dB
VQ Nominal Voltage			VA/2		V
Output Impedance		-	25	-	kΩ
Maximum allowable DC current source/sink			10		μA
Filt+ Nominal Voltage			VA		V
Output Impedance		-	4.4	-	kΩ
Maximum allowable DC current source/sink			10		μA

**ANALOG CHARACTERISTICS (COMMERCIAL)**

Test Conditions (unless otherwise specified).  $V_A = 5\text{ V}$ ,  $V_D = V_{LS} = V_{LC} = 3.3\text{ V}$ , and  $T_A = 25^\circ\text{ C}$ . Full-scale input sine wave. Measurement Bandwidth is 10 Hz to 20 kHz.

Parameter	Symbol	Min	Typ	Max	Unit
<b>Single-Speed Mode</b> $F_s = 48\text{ kHz}$					
Dynamic Range	A-weighted	108	114	-	dB
	unweighted	105	111	-	
Total Harmonic Distortion + Noise referred to typical full scale	-1 dB	THD+N	-105	-99	dB
	-20 dB		-91	-	
	-60 dB		-51	-45	
<b>Double-Speed Mode</b> $F_s = 96\text{ kHz}$					
Dynamic Range	A-weighted	108	114	-	dB
	unweighted	105	111		
	40 kHz bandwidth unweighted	-	108		
Total Harmonic Distortion + Noise referred to typical full scale	-1 dB	THD+N	-105	-99	dB
	-20 dB		-91	-	
	-60 dB		-51	-45	
	40 kHz bandwidth		-102	-	
<b>Quad-Speed Mode</b> $F_s = 192\text{ kHz}$					
Dynamic Range	A-weighted	108	114	-	dB
	unweighted	105	111		
	40 kHz bandwidth unweighted	-	108		
Total Harmonic Distortion + Noise referred to typical full scale	-1 dB	THD+N	-105	-99	dB
	-20 dB		-91	-	
	-60 dB		-51	-45	
	40 kHz bandwidth		-102	-	
<b>Dynamic Performance for All Modes</b>					
Interchannel Isolation		-	110	-	dB
<b>DC Accuracy</b>					
Interchannel Gain Mismatch		-	0.1	-	dB
Gain Error		-5	-	5	%
Gain Drift		-	$\pm 100$	-	ppm/ $^\circ\text{C}$
Offset Error	HPF enabled	0	-	-	LSB
	HPF disabled	-	-	100	
<b>Analog Input Characteristics</b>					
Full-scale Differential Input Voltage		1.07* $V_A$	1.13* $V_A$	1.19* $V_A$	$V_{pp}$
Input Impedance (Differential)		-	250	-	$k\Omega$
Common Mode Rejection Ratio	CMRR	-	82	-	dB

## ANALOG PERFORMANCE (AUTOMOTIVE)

Test Conditions (unless otherwise specified).  $V_A = 5.25$  to  $4.75$  V,  $V_D = 5.25$  to  $3.14$  V,  $V_{LS} = V_{LC} = 5.25$  to  $1.71$  V and  $T_A = -40^\circ$  to  $+85^\circ$  C. Full-scale input sine wave. Measurement Bandwidth is 10 Hz to 20 kHz.

Parameter	Symbol	Min	Typ	Max	Unit	
<b>Single-Speed Mode</b> $F_s = 48$ kHz						
Dynamic Range	A-weighted unweighted	106 103	114 111	-	dB	
Total Harmonic Distortion + Noise referred to typical full scale	-1 dB -20 dB -60 dB	THD+N	-	-105 -91 -51	-97 - -45	dB
<b>Double-Speed Mode</b> $F_s = 96$ kHz						
Dynamic Range	A-weighted unweighted 40 kHz bandwidth unweighted	106 103 -	114 111 108	-	dB	
Total Harmonic Distortion + Noise referred to typical full scale	-1 dB -20 dB -60 dB 40 kHz bandwidth	THD+N	-	-105 -91 -51 -102	-97 - -45 -	dB
<b>Quad-Speed Mode</b> $F_s = 192$ kHz						
Dynamic Range	A-weighted unweighted 40 kHz bandwidth unweighted	106 103 -	114 111 108	-	dB	
Total Harmonic Distortion + Noise referred to typical full scale	-1 dB -20 dB -60 dB 40 kHz bandwidth	THD+N	-	-105 -91 -51 -102	-97 - -45 -	dB
<b>Dynamic Performance for All Modes</b>						
Interchannel Isolation		-	110	-	dB	
<b>DC Accuracy</b>						
Interchannel Gain Mismatch		-	0.1	-	dB	
Gain Error		-7	-	7	%	
Gain Drift		-	$\pm 100$	-	ppm/ $^\circ$ C	
Offset Error	HPF enabled HPF disabled	0 -	- -	- 100	LSB	
<b>Analog Input Characteristics</b>						
Full-scale Input Voltage		1.02* $V_A$	1.13* $V_A$	1.24* $V_A$	$V_{pp}$	
Input Impedance (Differential)			250	-	k $\Omega$	
Common Mode Rejection Ratio	CMRR	-	82	-	dB	

**DIGITAL FILTER CHARACTERISTICS**

Parameter	Symbol	Min	Typ	Max	Unit
<b>Single-Speed Mode (2 kHz to 54 kHz sample rates)</b>					
Passband (Note 1) (-0.1 dB)		0	-	0.47	Fs
Passband Ripple		-0.035		0.035	dB
Stopband (Note 1)		0.58		Fs	
Stopband Attenuation		-95		dB	
Total Group Delay (Fs = Output Sample Rate)	$t_{gd}$	-		12/Fs	s
<b>Double-Speed Mode (54 kHz to 108 kHz sample rates)</b>					
Passband (Note 1) (-0.1 dB)		0	-	0.45	Fs
Passband Ripple		-0.035		0.035	dB
Stopband (Note 1)		0.68		Fs	
Stopband Attenuation		-92		dB	
Total Group Delay (Fs = Output Sample Rate)	$t_{gd}$	-		9/Fs	s
<b>Quad-Speed Mode (108 kHz to 216 kHz sample rates)</b>					
Passband (Note 1) (-0.1 dB)		0	-	0.24	Fs
Passband Ripple		-0.035		0.035	dB
Stopband (Note 1)		0.78		Fs	
Stopband Attenuation		-92		dB	
Total Group Delay (Fs = Output Sample Rate)	$t_{gd}$	-		5/Fs	s
<b>High-Pass Filter Characteristics</b>					
Frequency Response (Note 2)	-3.0 dB -0.13 dB	-	1 20	-	Hz
Phase Deviation (Note 2)	@ 20 Hz	-	10	-	Deg
Passband Ripple		-	-	0	dB
Filter Settling Time		-	$10^5/Fs$	-	s

**Notes:**

1. The filter frequency response scales precisely with Fs.
2. Response shown is for Fs equal to 48 kHz. Filter characteristics scale with Fs.

**OVERFLOW TIMEOUT**

Logic "0" = GND = 0 V; Logic "1" = VLS;  $C_L = 30$  pF, timing threshold is 50% of VLS.

Parameter	Symbol	Min	Typ	Max	Unit
<b>OVFL time-out on overrange condition</b> Fs = 44.1 kHz Fs = 192 kHz		-	$(2^{17}-1)/Fs$ 2972 683	-	ms

## SERIAL AUDIO INTERFACE - I<sup>2</sup>S/LJ TIMING

The serial audio port is a three-pin interface consisting of SCLK, LRCK and SDOUT. Logic "0" = GND = 0 V; Logic "1" = VLS; C<sub>L</sub> = 20 pF, timing threshold is 50% of VLS.

Parameter	Symbol	Min	Typ	Max	Unit
Sample Rates	Single-Speed Mode Double-Speed Mode Quad-Speed Mode	2 54 108	-	54 108 216	kHz
<b>Master Mode</b>					
SCLK Frequency	-	64*Fs	-	64*Fs	Hz
SCLK Period	1/(64*216 kHz)	t <sub>PERIOD</sub>	72.3	-	ns
SCLK Duty Cycle (Note 1)	(CLKMODE = 0)(Note 2)	t <sub>HIGH</sub>	40	50	%
	(CLKMODE = 1)(Note 2)	t <sub>HIGH</sub>	28	33	%
LRCK setup	before SCLK rising	t <sub>SETUP1</sub>	20	-	ns
LRCK hold	after SCLK rising	t <sub>HOLD1</sub>	20	-	ns
SDOUT setup	before SCLK rising	t <sub>SETUP2</sub>	10	-	ns
SDOUT hold	after SCLK rising (VLS = 1.8 V)	t <sub>HOLD2</sub>	20	-	ns
	after SCLK rising (VLS = 3.3 V)	t <sub>HOLD2</sub>	10	-	ns
	after SCLK rising (VLS = 5 V)	t <sub>HOLD2</sub>	5	-	ns
<b>Slave Mode</b>					
SCLK Frequency (Note 3)	-	-	64*Fs	-	Hz
SCLK Period	1/(64*216 kHz)	t <sub>PERIOD</sub>	72.3	-	ns
SCLK Duty Cycle		t <sub>HIGH</sub>	28	65	%
LRCK setup	before SCLK rising	t <sub>SETUP1</sub>	20	-	ns
LRCK hold	after SCLK rising	t <sub>HOLD1</sub>	20	-	ns
SDOUT setup	before SCLK rising (VLS = 1.8 V)	t <sub>SETUP2</sub>	4	-	ns
	before SCLK rising (VLS = 3.3 V)	t <sub>SETUP2</sub>	10	-	ns
	before SCLK rising (VLS = 5 V)	t <sub>SETUP2</sub>	10	-	ns
SDOUT hold	after SCLK rising (VLS = 1.8 V)	t <sub>HOLD2</sub>	20	-	ns
	after SCLK rising (VLS = 3.3 V)	t <sub>HOLD2</sub>	10	-	ns
	after SCLK rising (VLS = 5 V)	t <sub>HOLD2</sub>	5	-	ns

### Notes:

1. Duty cycle of generated SCLK depends on duty cycle of received MCLK as specified under "System Clocking" on page 10.
2. CLKMODE functionality described in Section 4.6.3 "Master Mode Clock Dividers" on page 24.
3. In Slave Mode, the SCLK/LRCK ratio can be set according to preference. However, chip performance is guaranteed only when using the ratios in Section 4.7 Master and Slave Clock Frequencies on page 25.

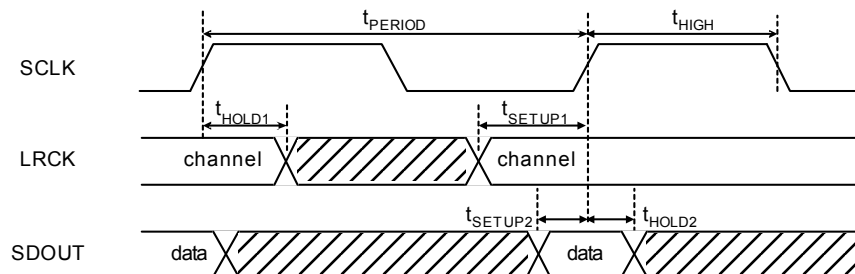


Figure 3. I<sup>2</sup>S/LJ Timing

## SERIAL AUDIO INTERFACE - TDM TIMING

The serial audio port is a three-pin interface consisting of SCLK, LRCK and SDOUT. Logic "0" = GND = 0 V; Logic "1" = VLS;  $C_L = 20$  pF, timing threshold is 50% of VLS.

Parameter		Symbol	Min	Typ	Max	Unit
Sample Rates	Single-Speed Mode	-	2	-	54	kHz
	Double-Speed Mode	-	54	-	108	kHz
	Quad-Speed Mode <sup>1</sup>	-	108	-	216	kHz
<b>Master Mode</b>						
SCLK Frequency			$256 \cdot F_s$	-	$256 \cdot F_s$	Hz
SCLK Period	$1/(256 \cdot 216 \text{ kHz})$	$t_{PERIOD}$	18	-	-	ns
SCLK Duty Cycle (Note 2)	(CLKMODE = 0)(Note 3)	$t_{HIGH1}$	40	50	60	%
	(CLKMODE = 1)(Note 3)	$t_{HIGH1}$	28	33	38	%
FS setup	before SCLK rising (Single-Speed Mode)	$t_{SETUP1}$	20	-	-	ns
FS setup	before SCLK rising (Double-Speed Mode)	$t_{SETUP1}$	18	-	-	ns
FS setup	before SCLK rising (Quad-Speed Mode)	$t_{SETUP1}$	5	-	-	ns
FS width	in SCLK cycles	$t_{HIGH2}$	128	-	128	-
SDOUT setup	before SCLK rising	$t_{SETUP2}$	5	-	-	ns
SDOUT hold	after SCLK rising	$t_{HOLD2}$	5	-	-	ns
<b>Slave Mode</b>						
SCLK Frequency (Note 4)			-	$256 \cdot F_s$	-	Hz
SCLK Period	$1/(256 \cdot 216 \text{ kHz})$	$t_{PERIOD}$	18	-	-	ns
SCLK Duty Cycle		$t_{HIGH1}$	28	-	65	%
FS setup	before SCLK rising (Single-Speed Mode)	$t_{SETUP1}$	20	-	-	ns
FS setup	before SCLK rising (Double-Speed Mode)	$t_{SETUP1}$	20	-	-	ns
FS setup	before SCLK rising (Quad-Speed Mode)	$t_{SETUP1}$	10	-	-	ns
FS width	in SCLK cycles	$t_{HIGH2}$	1	-	244	-
SDOUT setup	before SCLK rising	$t_{SETUP2}$	5	-	-	ns
SDOUT hold	after SCLK rising	$t_{HOLD2}$	5	-	-	ns

### Notes:

1. TDM Quad-Speed Mode only specified to operate correctly at  $VLS \geq 3.14$  V.
2. Duty cycle of generated SCLK depends on duty cycle of received MCLK as specified under "System Clocking" on page 10.
3. CLKMODE functionality described in Section 4.6.3 "Master Mode Clock Dividers" on page 24.
4. In Slave Mode, the SCLK/LRCK ratio can be set according to preference; chip performance is guaranteed only when using the ratios in Section 4.7 Master and Slave Clock Frequencies on page 25.

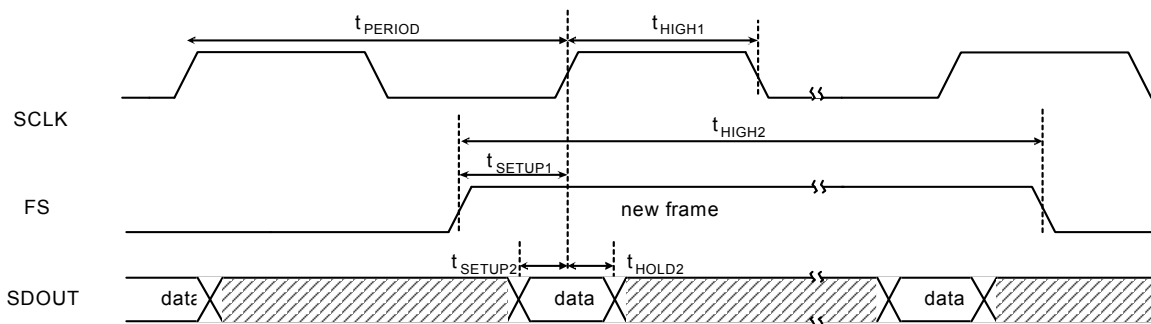


Figure 4. TDM Timing



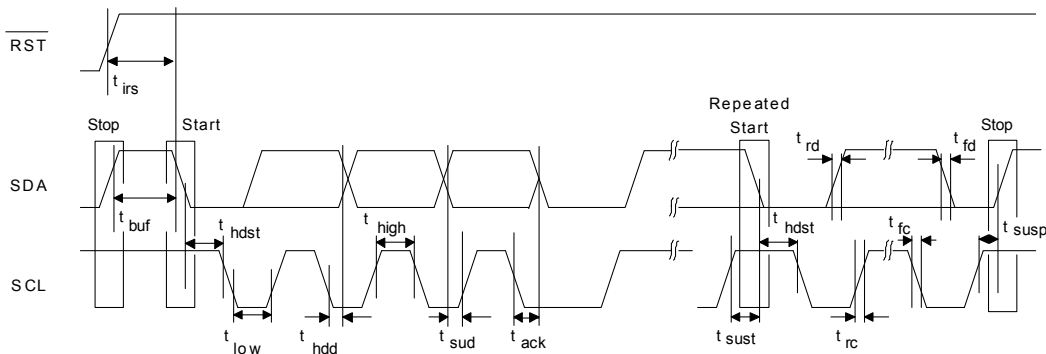
## SWITCHING SPECIFICATIONS - CONTROL PORT - I<sup>2</sup>C TIMING

Inputs: Logic 0 = DGND, Logic 1 = VLC, SDA C<sub>L</sub> = 30 pF

Parameter	Symbol	Min	Max	Unit	
SCL Clock Frequency	f <sub>scl</sub>	-	100	kHz	
RST Rising Edge to Start	t <sub>irs</sub>	600	-	ns	
Bus Free Time Between Transmissions	t <sub>buf</sub>	4.7		μs	
Start Condition Hold Time (prior to first clock pulse)	t <sub>hdst</sub>	4.0		μs	
Clock Low time	t <sub>low</sub>	4.7			
Clock High Time	t <sub>high</sub>	4.0			
Setup Time for Repeated Start Condition	t <sub>sust</sub>	4.7			
SDA Hold Time from SCL Falling	t <sub>hdd</sub>	0			
SDA Setup time to SCL Rising	t <sub>sud</sub>	600			ns
Rise Time of SCL and SDA	t <sub>rc</sub>	-		1	μs
Fall Time SCL and SDA	t <sub>fc</sub>	-		300	ns
Setup Time for Stop Condition	t <sub>susp</sub>	4.7	-	μs	
Acknowledge Delay from SCL Falling	t <sub>ack</sub>	300	1000	ns	

### Notes:

- Data must be held for sufficient time to bridge the transition time, t<sub>rc</sub>, of SCL.



**Figure 5. I<sup>2</sup>C Timing**

- The operational timing specification deviates from the *I<sup>2</sup>C-Bus Specification and User Manual* of 250 ns.

## SWITCHING SPECIFICATIONS - CONTROL PORT - SPI TIMING

Inputs: Logic 0 = DGND, Logic 1 = VLC, CDOUT  $C_L = 30$  pF

Parameter	Symbol	Min	Max	Units	
CCLK Clock Frequency	$f_{sck}$	0	6.0	MHz	
$\overline{RST}$ Rising Edge to $\overline{CS}$ Falling	$t_{srs}$	20	-	ns	
$\overline{CS}$ Falling to CCLK Edge	$t_{css}$	20			
$\overline{CS}$ High Time Between Transmissions	$t_{csh}$	1.0		μs	
CCLK Low Time	$t_{scl}$	66			
CCLK High Time	$t_{sch}$	66			
CDIN to CCLK Rising Setup Time	$t_{dsu}$	40			
CCLK Rising to DATA Hold Time (Note 1)	$t_{dh}$	15			
CCLK Falling to CDOUT Stable	$t_{pd}$	-		50	ns
Rise Time of CDOUT	$t_{r1}$			25	
Fall Time of CDOUT	$t_{f1}$			100	
Rise Time of CCLK and CDIN (Note 2)	$t_{r2}$				
Fall Time of CCLK and CDIN (Note 2)	$t_{f2}$				

### Notes:

1. Data must be held for sufficient time to bridge the transition time of CCLK.
2. For  $f_{sck} < 1$  MHz

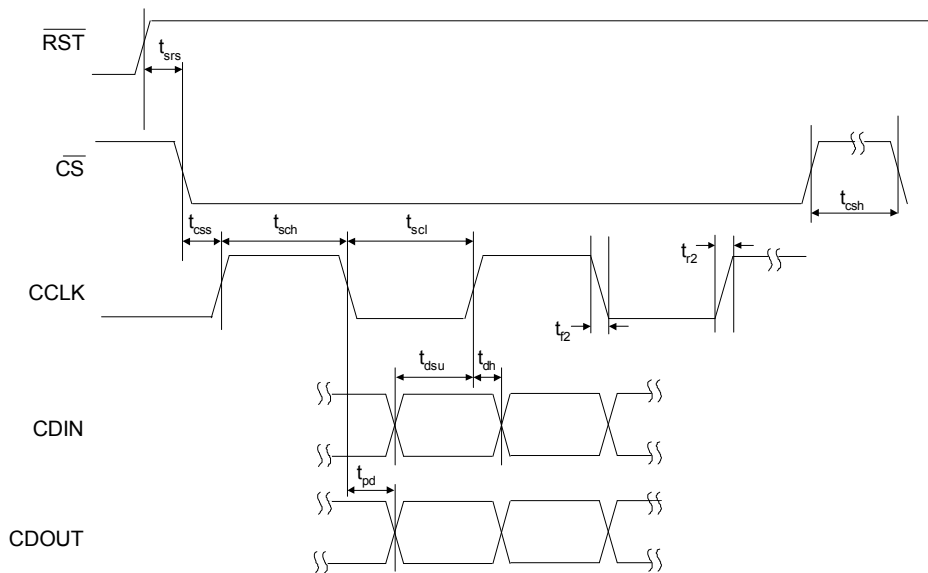


Figure 6. SPI Timing

## 4. APPLICATIONS

### 4.1 Power

CS5366 features five independent power pins that power various functional blocks within the device and allow for convenient interfacing to other devices. [Table 1](#) shows what portion of the device is powered from each supply pin. Please refer to [“Recommended Operating Conditions” on page 10](#) for the valid range of each power supply pin. The power supplied to each power pin can be independent of the power supplied to any other pin.

Power Supply Pin		
Pin Name	Pin Number	Functional Block
VA	4, 9	Analog Core
VX	20	Crystal Oscillator
VD	33	Digital Core
VLS	28	Serial Audio Interface
VLC	35	Control Logic

**Table 1. Power Supply Pin Definitions**

To meet full performance specifications, the CS5366 requires normal low-noise board layout. The [“Typical Connection Diagram” on page 9](#) shows the recommended power arrangements, with the VA pins connected to a clean supply. VD, which powers the digital filter, may be run from the system logic supply, or it may be powered from the analog supply via a single-pole decoupling filter.

Decoupling capacitors should be placed as near to the ADC as possible, with the lower value high-frequency capacitors placed nearest to the device leads. Clocks should be kept away from the FILT+ and VQ pins in order to avoid unwanted coupling of these signals into the device. The FILT+ and VQ decoupling capacitors must be positioned to minimize the electrical path to ground.

The CDB5366 evaluation board demonstrates optimum layout for the device.

### 4.2 Control Port Mode and Stand-Alone Operation

#### 4.2.1 Stand-Alone Mode

In Stand-Alone Mode, the CS5366 is programmed exclusively with multi-use configuration pins. This mode provides a set of commonly used features, which comprise a subset of the complete set of device features offered in Control Port Mode.

To use the CS5366 in Stand-Alone Mode, the configuration pins must be held in a stable state, at valid logic levels, and RST must be asserted until the power supplies and clocks are stable and valid. More information on the reset function is available in [Section 4.5 on page 22](#).

#### 4.2.2 Control Port Mode

In Control Port Mode, all features of the CS5366 are available. Four multi-use configuration pins become software pins that support the I<sup>2</sup>C or SPI bus protocol. To initiate Control Port Mode, a controller that supports I<sup>2</sup>C or SPI must be used to enable the internal register functionality. This is done by setting the CP-EN bit (Bit 7 of the Global Control Port Register). Once CP-EN is set, all of the device configuration pins are ignored, and the internal register settings determine the operating modes of the part. [Figure 4.13 on page 30](#) provides detailed information about the I<sup>2</sup>C and SPI bus protocols.

### 4.3 Master Clock Source

The CS5366 requires a Master Clock that can come from one of two sources: an on-chip crystal oscillator driver or an externally generated clock.

#### 4.3.1 On-Chip Crystal Oscillator Driver

When using the on-board crystal oscillator driver, the XTI pin (pin 21) is the input for the Master Clock (MCLK) to the device. The XTO pin (pin 22) must not be used to drive anything other than the oscillator tank circuitry. When using the on-board crystal driver, the topology shown in [Figure 7](#) must be used. The crystal oscillator manufacturer supplies recommended capacitor values. A buffered copy of the XTI input is available as an output on the MCLK pin (pin 23), which is level-controlled by VLS and may be used to synchronize other parts to the device.

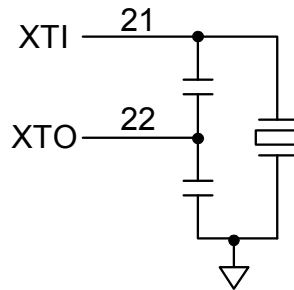


Figure 7. Crystal Oscillator Topology

#### 4.3.2 Externally Generated Master Clock

If an external clock is used, the XTI and XTO pins must be grounded, and the MCLK pin becomes an input for the system master clock. The incoming MCLK should be at the logic level set by the user on the VLS supply pin.

## 4.4 Master and Slave Operation

CS5366 operation depends on two clocks that are synchronously derived from MCLK: SCLK and LRCK/FS. See [Section 4.5 on page 22](#) for a detailed description of SCLK and LRCK/FS.

The CS5366 can operate as either clock master or clock slave with respect to SCLK and LRCK/FS. In Master Mode, the CS5366 derives SCLK and LRCK/FS synchronously from MCLK and outputs the derived clocks on the SCLK pin (pin 25) and the LRCK/FS pin (pin 24), respectively. In Slave Mode, the SCLK and LRCK/FS are inputs, and the input signals must be synchronously derived from MCLK by a separate device such as another CS5366 or a microcontroller. [Figure 8](#) illustrates the clock flow of SCLK and LRCK/FS in both Master and Slave Modes.

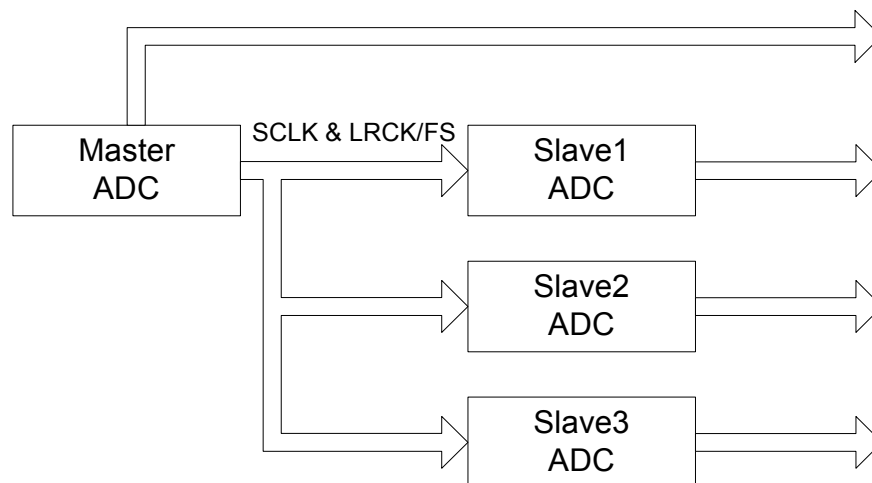
The Master/Slave operation is controlled through the settings of M1 and M0 pins in Stand-Alone Mode or by the M[1] and M[0] bits in the Global Mode Control Register in Control Port Mode. See [Section 4.6 on page 23](#) for more information regarding the configuration of M1 and M0 pins or M[1] and M[0] bits.



**Figure 8. Master/Slave Clock Flow**

### 4.4.1 Synchronization of Multiple Devices

To ensure synchronous sampling in applications where multiple ADCs are used, the MCLK and LRCK must be the same for all CS5366 devices in the system. If only one master clock source is needed, one solution is to place one CS5366 in Master Mode, and slave all of the other devices to the one master, as illustrated in [Figure 9](#). If multiple master clock sources are needed, one solution is to supply all clocks from the same external source and time the CS5366 reset de-assertion with the falling edge of MCLK. This will ensure that all converters begin sampling on the same clock edge.



**Figure 9. Master and Slave Clocking for a Multi-Channel Application**

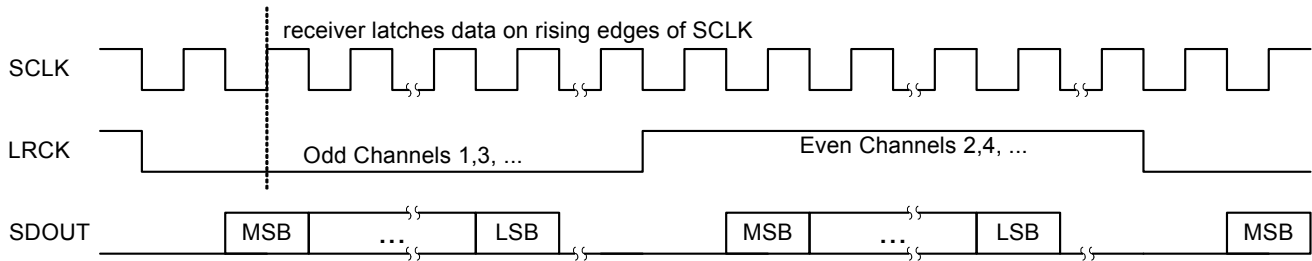
## 4.5 Serial Audio Interface (SAI) Format

The SAI port consists of two timing pins (SCLK, LRCK/FS) and four audio data output pins (SDOUT1/TDM, SDOUT2, SDOUT3/TDM and SDOUT4). The CS5366 output is serial data in I<sup>2</sup>S, Left-Justified (LJ), or Time Division Multiplexed (TDM) digital audio interface formats. These formats are available to the user in both Stand-Alone Mode and Control Port Mode.

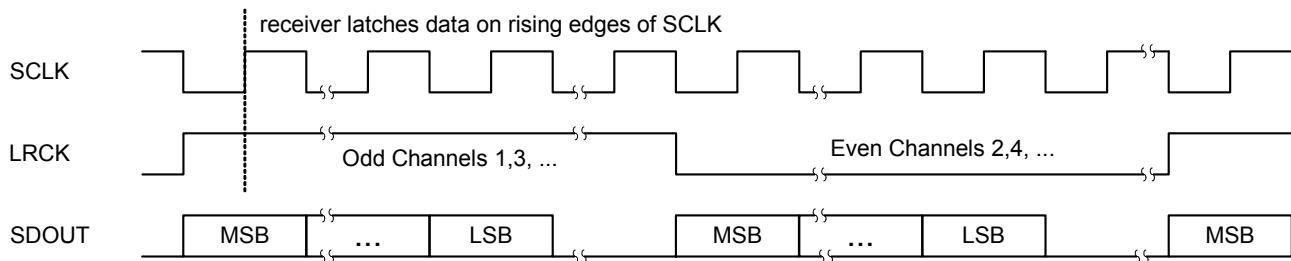
### 4.5.1 I<sup>2</sup>S and LJ Format

The I<sup>2</sup>S and LJ formats are both two-channel protocols. During one LRCK period, two channels of data are transmitted, odd channels first, then even. The MSB is always clocked out first.

In Slave Mode, the number of SCLK cycles per channel is fixed as described under “[Serial Audio Interface - I<sup>2</sup>S/LJ Timing](#)” on page 15. In Slave Mode, if more than 32 SCLK cycles per channel are received from a master controller, the CS5366 will fill the longer frame with trailing zeros. If fewer than 24 SCLK cycles per channel are received from a master, the CS5366 will truncate the serial data output to the number of SCLK cycles received. For a complete overview of serial audio interface formats, please refer to Cirrus Logic Application Note AN282.



**Figure 10. I<sup>2</sup>S Format**



**Figure 11. LJ Format**

## 4.5.2 TDM Format

In TDM Mode, all six channels of audio data are serially clocked out during a single Frame Sync (FS) cycle, as shown in Figure 12. The rising edge of FS signifies the start of a new TDM frame cycle. Each channel slot occupies 32 SCLK cycles, with the data left justified and with MSB first. TDM output data should be latched on the rising edge of SCLK within time specified under “Serial Audio Interface - TDM Timing” section on page 16. The TDM data output port resides on the SDOUT1 pin. The TDM output pin is complimentary TDM data. All SDOUT pins will remain active during TDM Mode. Refer to Section 4.11 “Optimizing Performance in TDM Mode” on page 29 for critical system design information.

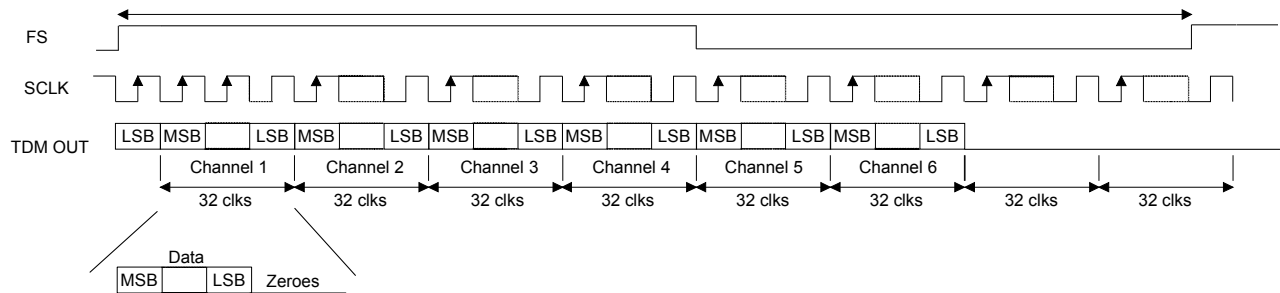


Figure 12. TDM Format

## 4.5.3 Configuring Serial Audio Interface Format

The serial audio interface format of the data is controlled by the configuration of the DIF1 and DIF0 pins in Stand-Alone Mode or by the DIF[1] and DIF[0] bits in the Global Mode Control Register in Control Port Mode, as shown in Table 2.

DIF1	DIF0	Mode
0	0	Left-Justified
0	1	I <sup>2</sup> S
1	0	TDM
1	1	Reserved

Table 2. DIF1 and DIF0 Pin Settings

## 4.6 Speed Modes

### 4.6.1 Sample Rate Ranges

CS5366 supports sampling rates from 2 kHz to 21 kHz, divided into three ranges: 2 kHz - 54 kHz, 54 kHz - 108 kHz, and 108 kHz - 216 kHz. These sampling speed modes are called Single-Speed Mode (SSM), Double-Speed Mode (DSM), and Quad-Speed Mode (QSM), respectively.

### 4.6.2 Using M1 and M0 to Set Sampling Parameters

The Master/Slave operation and the sample rate range are controlled through the settings of the M1 and M0 pins in Stand-Alone Mode, or by the M[1] and M[0] bits in the Global Mode Control Register in Control Port Mode, as shown in Table 3.

M1	M0	Mode	Frequency Range
0	0	Single-Speed Master Mode (SSM)	2 kHz - 54 kHz
0	1	Double-Speed Master Mode (DSM)	54 kHz - 108 kHz
1	0	Quadruple-Speed Master Mode (QSM)	108 kHz - 216 kHz
1	1	Auto-Detected Speed Slave Mode	2 kHz - 216 kHz

Table 3. M1 and M0 Settings

### 4.6.3 Master Mode Clock Dividers

Figure 13 shows the configuration of the MCLK dividers and the sample rate dividers for Master Mode, including the significance of each MCLK divider pin (in Stand-Alone Mode) or bit (in Control Port Mode).

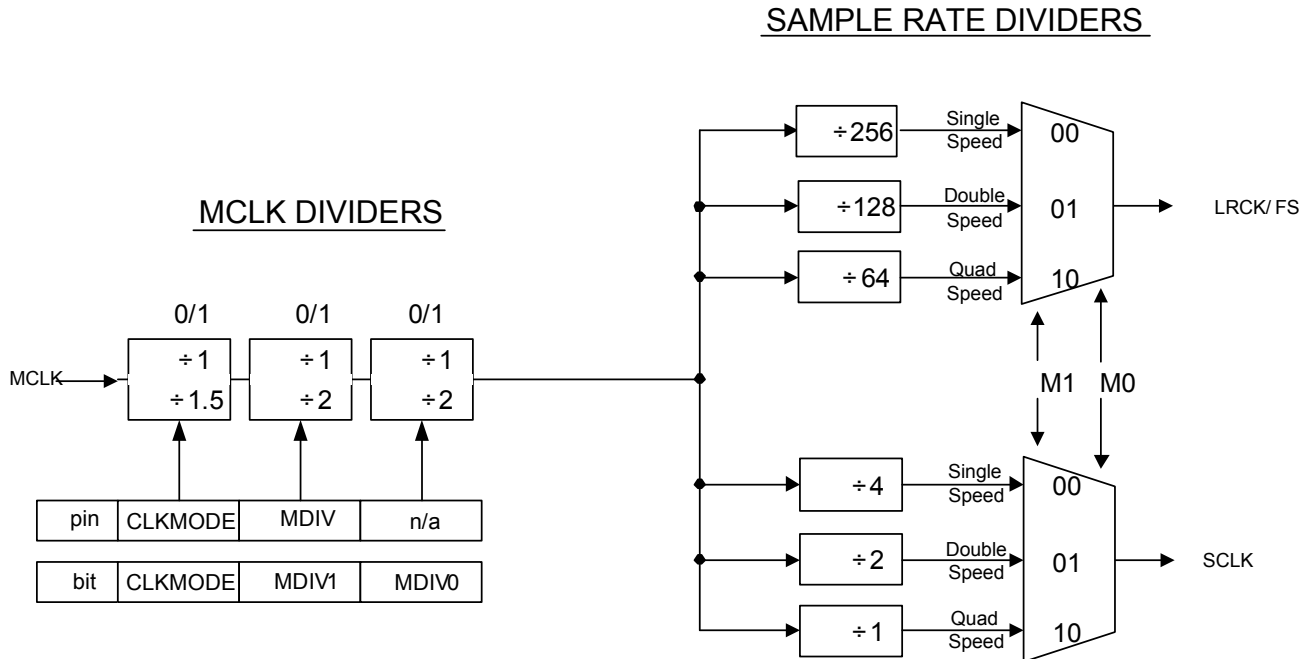


Figure 13. Master Mode Clock Dividers

### 4.6.4 Slave Mode Audio Clocking With Auto-Detect

In Slave Mode, CS5366 auto-detects speed mode, which eliminates the need to configure M1 and M0 when changing among speed modes. The external MCLK is subject to clock dividers as set by the clock divider pins in Stand-Alone Mode or the clock divider bits in Control Port Mode. The CS5366 compares the divided-down, internal MCLK to the incoming LRCK/FS and sets the speed mode based on the MCLK/LRCK ratio as shown in Figure 14.

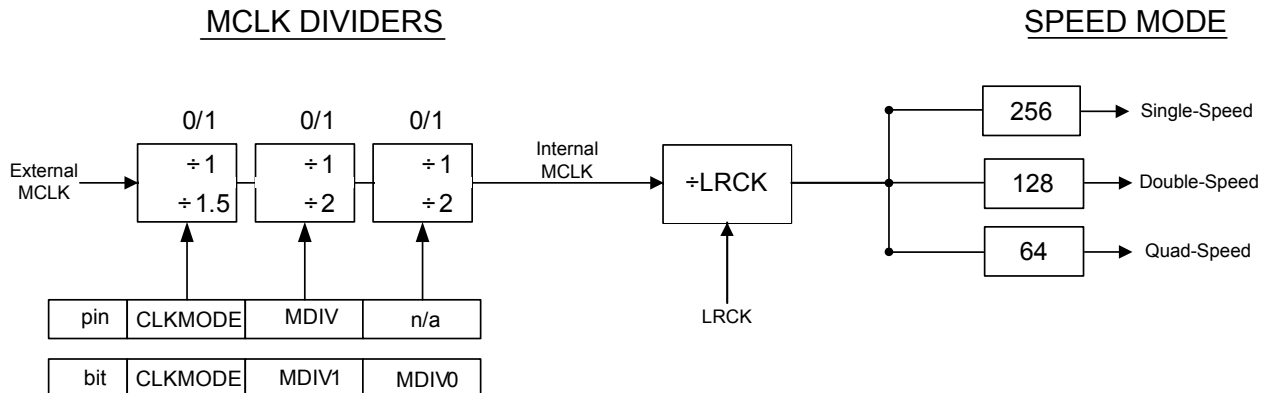


Figure 14. Slave Mode Auto-Detect Speed



## 4.7 Master and Slave Clock Frequencies

Tables 4 through 12 show the clock speeds for sample rates of 48 kHz, 96 kHz and 192 kHz. The MCLK/LRCK ratio should be kept at a constant value during each mode. In Master Mode, the device outputs the frequencies shown. In Slave Mode, the SCLK/LRCK ratio can be set according to design preference. However, device performance is guaranteed only when using the ratios shown in the tables.

Control Port Mode only

LJ/I <sup>2</sup> S MASTER OR SLAVE	SSM Fs = 48 kHz				
MCLK Divider	÷4	÷3	÷2	÷1.5	÷1
MCLK (MHz)	49.152	36.864	24.576	18.384	12.288
SCLK (MHz)	3.072	3.072	3.072	3.072	3.072
MCLK/LRCK Ratio	1024	768	512	384	256
SCLK/LRCK Ratio	64	64	64	64	64

Table 4. Frequencies for 48 kHz Sample Rate using LJ/I<sup>2</sup>S

LJ/I <sup>2</sup> S MASTER OR SLAVE	DSM Fs = 96 kHz				
MCLK Divider	÷4	÷3	÷2	÷1.5	÷1
MCLK (MHz)	49.152	36.864	24.567	18.384	12.288
SCLK (MHz)	6.144	6.144	6.144	6.144	6.144
MCLK/LRCK Ratio	512	384	256	192	128
SCLK/LRCK Ratio	64	64	64	64	64

Table 5. Frequencies for 96 kHz Sample Rate using LJ/I<sup>2</sup>S

LJ/I <sup>2</sup> S MASTER OR SLAVE	QSM Fs = 192 kHz				
MCLK Divider	÷4	÷3	÷2	÷1.5	÷1
MCLK (MHz)	49.152	36.864	24	18.384	12.288
SCLK (MHz)	12.288	12.288	12.288	12.288	12.288
MCLK/LRCK Ratio	256	192	128	96	64
SCLK/LRCK Ratio	64	64	64	64	64

Table 6. Frequencies for 192 kHz Sample Rate using LJ/I<sup>2</sup>S

TDM MASTER	SSM Fs = 48 kHz				
MCLK Divider	÷4	÷3	÷2	÷1.5	÷1
MCLK (MHz)	49.152	36.864	24.567	18.384	12.288
SCLK (MHz)	12.288	12.288	12.288	12.288	12.288
MCLK/FS Ratio	1024	768	512	384	256
SCLK/FS Ratio	256	256	256	256	256

Table 7. Frequencies for 48 kHz Sample Rate using TDM

TDM SLAVE	SSM Fs = 48 kHz				
MCLK Divider	÷4	÷3	÷2	÷1.5	÷1
MCLK (MHz)	49.152	36.864	24.567	18.384	12.288
SCLK (MHz)	12.288	12.288	12.288	12.288	12.288
MCLK/FS Ratio	1024	768	512	384	256
SCLK/FS Ratio	256	256	256	256	256

Table 8. Frequencies for 48 kHz Sample Rate using TDM

<b>TDM MASTER</b>	<b>DSM Fs = 96 kHz</b>				
MCLK Divider	$\div 4$	$\div 3$	$\div 2$	-	-
MCLK (MHz)	49.152	36.864	24.567	-	-
SCLK (MHz)	24.576	24.576	24.576	-	-
MCLK/FS Ratio	512	384	256	-	-
SCLK/FS Ratio	256	256	256	-	-

**Table 9. Frequencies for 96 kHz Sample Rate using TDM**

<b>TDM SLAVE</b>	<b>DSM Fs = 96 kHz</b>				
MCLK Divider	$\div 4$	$\div 3$	$\div 2$	$\div 1.5$	$\div 1$
MCLK (MHz)	49.152	36.864	24.567	18.384	12.288
SCLK (MHz)	24.576	24.576	24.576	24.576	24.576
MCLK/FS Ratio	512	384	256	192	128
SCLK/FS Ratio	256	256	256	256	256

**Table 10. Frequencies for 96 kHz Sample Rate using TDM**

<b>TDM MASTER</b>	<b>QSM Fs = 192 kHz</b>				
MCLK Divider	$\div 4$	-	-	-	-
MCLK (MHz)	49.152	-	-	-	-
SCLK (MHz)	49.152	-	-	-	-
MCLK/FS Ratio	256	-	-	-	-
SCLK/FS Ratio	256	-	-	-	-

**Table 11. Frequencies for 192 kHz Sample Rate using TDM**

<b>TDM SLAVE</b>	<b>QSM Fs = 192 kHz</b>				
MCLK Divider	$\div 4$	$\div 3$	$\div 2$	$\div 1.5$	$\div 1$
MCLK (MHz)	49.152	36.864	24.567	18.384	12.288
SCLK (MHz)	49.152	49.152	49.152	49.152	49.152
MCLK/FS Ratio	256	192	128	96	64
SCLK/FS Ratio	256	256	256	256	256

**Table 12. Frequencies for 192 kHz Sample Rate using TDM**

## 4.8 Reset

The device should be held in reset until power is applied and all incoming clocks are stable and valid. Upon de-assertion of  $\overline{\text{RST}}$ , the state of the configuration pins is latched, the state machine begins, and the device starts sending audio output data a maximum of 524288 MCLK cycles after the release of  $\overline{\text{RST}}$ . When changing between mode configurations in Stand-Alone Mode, including clock dividers, serial audio interface format, master/slave, or speed modes, it is recommended to reset the device following the change by holding the  $\overline{\text{RST}}$  pin low for a minimum of one MCLK cycle and then restoring the pin to a logic-high condition.

### 4.8.1 Power-Down Mode

The CS5366 features a Power-Down Mode in which power is temporarily withheld from the modulators, the crystal oscillator driver, the digital core, and the serial port. The user can access Power-Down Mode by holding the device in reset and holding all clock lines at a static, valid logic level (either logic-high or logic-low). “DC Power” on page 11 shows the power-saving associated with Power-Down Mode.

## 4.9 Overflow Detection

### 4.9.1 Overflow in Stand-Alone Mode

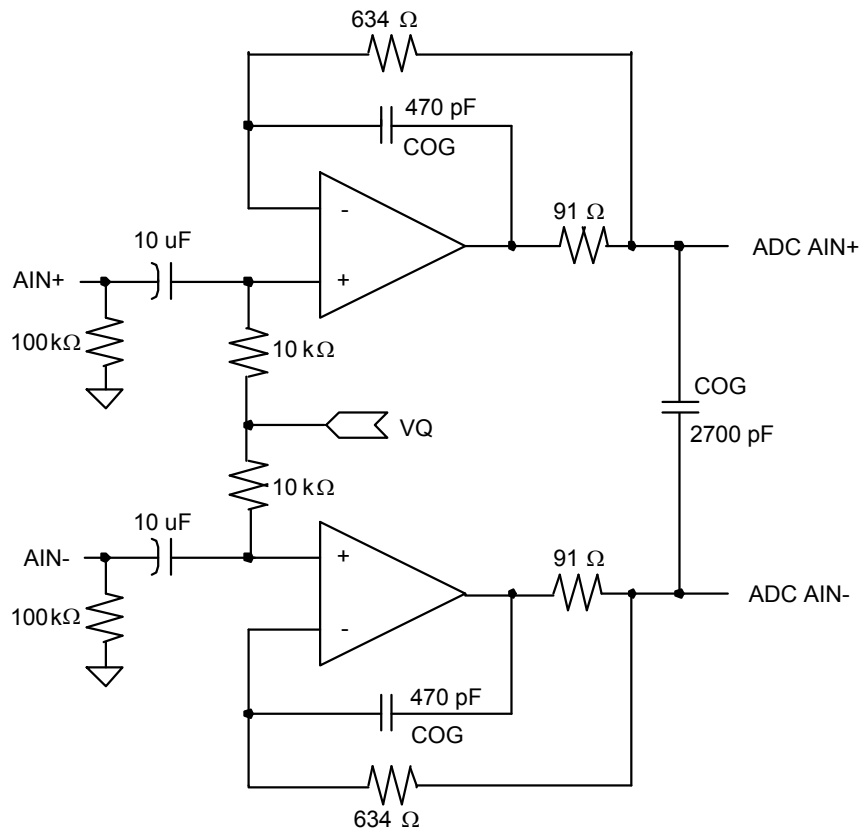
The CS5366 includes overflow detection on all input channels. In Stand-Alone Mode, this information is presented as open drain, active low on the  $\overline{\text{OVFL}}$  pin. The pin will go to a logical low as soon as an over-range condition in any channel is detected. The data will remain low, then time-out as specified in Section “Overflow Timeout” on page 14. After the time-out, the  $\overline{\text{OVFL}}$  pin will return to a logical high if there has not been any other over-range condition detected. Note that an over-range condition on any channel will restart the time-out period.

### 4.9.2 Overflow in Control Port Mode

In Control Port Mode, the Overflow Status Register interacts with the Overflow Mask Register to provide interrupt capability for each individual channel. See Section 5.4 “02h (OVFL) Overflow Status Register” on page 33 for details on these two registers.

## 4.10 Analog Connections

The analog modulator samples the input at half of the internal Master Clock frequency, or 6.144 MHz nominally. The digital filter will reject signals within the stopband of the filter. However, there is no rejection of input signals that are at  $(N \times 6.144 \text{ MHz})$  the digital passband frequency, where  $n=0,1,2,\dots$ . Refer to [Figure 15](#), which shows the suggested filter that will attenuate any noise energy at 6.144 MHz in addition to providing the optimum source impedance for the modulators. The use of capacitors that have a large voltage coefficient (such as general-purpose ceramics) must be avoided since these can degrade signal linearity. COG capacitors are recommended for this application. For additional configurations, refer to Cirrus Application Note AN241.



**Figure 15. Recommended Analog Input Buffer**

## 4.11 Optimizing Performance in TDM Mode

Noise Management is a design technique that is utilized in the majority of audio A/D converters. Noise management is relatively simple conceptually. The goal of noise management is to interleave the on-chip digital activity with the analog sampling processes to ensure that the noise generated by the digital activity is minimized (ideally non-existent) when the analog sampling occurs. Noise management, when implemented properly, minimizes the on-chip interference between the analog and digital sections of the device. This technique has proven to be very effective and has simplified the process of implementing an A/D converter into a systems design. The dominant source of interference (and most difficult to control) is the activity on the serial audio interface (SAI). However, noise management becomes more difficult to implement as audio sample rates increase simply due to the fact that there is less time between transitions on the SAI.

The CS5366 A/D converter supports a multi-channel Time-Division-Multiplexed interface for Single, Double and Quad-Speed sampling modes. In Single-Speed Mode, sample rates below 50 kHz, the required frequencies of the audio serial ports are sufficiently low that it is possible to implement noise-management. In this mode, the performance of the devices are relatively immune to activity on the audio ports.

However, in Double-Speed and Quad-Speed modes there is insufficient time to implement noise management due to the required frequencies of the audio ports. Therefore, analog performance, both dynamic range and THD+N, can be degraded if the serial port transitions occur concurrently with the analog sampling. The magnitude of the interference is not only related to the timing of the transition but also the di/dt or transient currents associated with the activity on the serial ports. Even though there is insufficient time to properly implement noise management, the interference effects can be minimized by controlling the transient currents required of the serial ports in Double- and Quad-Speed TDM Modes.

In addition to standard mixed-signal design techniques, system performance can be maximized by following several guidelines during design.

- Operate the serial audio port at 3.3 V and not 5 V. The lower serial port voltage lowers transient currents.
- Operate the A/D converter as a system clock Slave. The serial clock and Left/Right clock become high-impedance inputs in this mode and do not generate significant transient currents.
- Place a buffer on the serial data output very near the A/D converter. Minimizing the stray capacitance of the printed circuit board trace and the loading presented by other devices on the serial data line will minimize the transient current.
- Place a resistor, near the converter, between the A/D serial data output and the buffer. This resistor will reduce the instantaneous switching currents into the capacitive loads on the nets, resulting in a slower edge rate. The value of the resistor should be as high as possible without causing timing problems elsewhere in the system.

## 4.12 DC Offset Control

The CS5366 includes a dedicated high-pass filter for each channel to remove input DC offset at the system level. A DC level may result in audible “clicks” when switching between devices in a multi-channel system.

In Stand-Alone Mode, all of the high-pass filters remain enabled. In Control Port Mode, the high-pass filters default to enabled, but may be controlled by writing to the  $\overline{\text{HPF}}$  register. If any  $\overline{\text{HPF}}$  bit is taken low, the respective high-pass filter is enabled, and it continuously subtracts a measure of the DC offset from the output of the decimation filter. If any  $\overline{\text{HPF}}$  bit is taken high during device operation, the value of the DC offset register is frozen, and this DC offset will continue to be subtracted from the conversion result.

## 4.13 Control Port Operation

The Control Port is used to read and write the internal device registers. It supports two industry standard formats, I<sup>2</sup>C and SPI. The part is in I<sup>2</sup>C format by default. SPI Mode is selected if there is ever a high-to-low transition on the AD0/ $\overline{CS}$  pin after the  $\overline{RST}$  pin has been restored high.

In Control Port Mode, all features of the CS5366 are available. Four multi-use configuration pins become software pins that support the I<sup>2</sup>C or SPI bus protocol. To initiate Control Port Mode, a controller that supports I<sup>2</sup>C or SPI must be used to enable the internal register functionality. This is done by setting the CP-EN bit (Bit 7 of the Global Control Port Register). Once CP-EN is set, all of the device configuration pins are ignored, and the internal register settings determine the operating modes of the part.

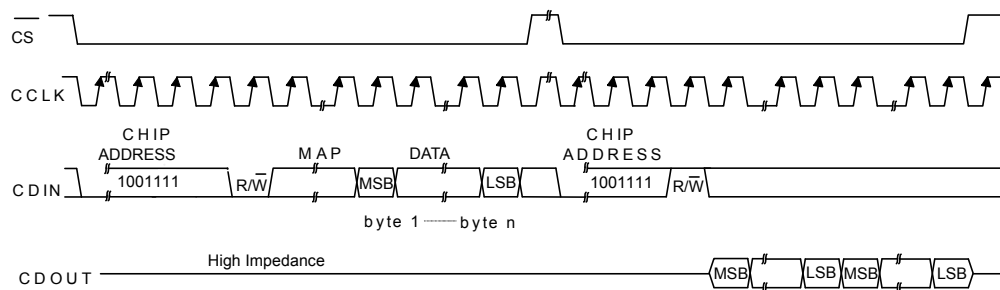
### 4.13.1 SPI Mode

In SPI Mode, CS is the CS5366 chip select signal; CCLK is the control port bit clock (input into the CS5366 from a controller); CDIN is the input data line from a controller; CDOUT is the output data line to a controller. Data is clocked in on the rising edge of CCLK and is supplied on the falling edge of CCLK.

To write to a register, bring CS low. The first seven bits on CDIN form the chip address and must be 1001111. The eighth bit is a read/write indicator (R/W), which should be low to write. The next eight bits form the Memory Address Pointer (MAP), which is set to the address of the register that is to be updated. The next eight bits are the data that will be placed into the register designated by the MAP. During writes, the CDOUT output stays in the Hi-Z state. It may be externally pulled high or low with a 47 k $\Omega$  resistor, if desired.

There is a MAP auto-increment capability, which is enabled by the INCR bit in the MAP register. If INCR is a zero, the MAP will stay constant for successive read or writes. If INCR is set to a 1, the MAP will auto-increment after each byte is read or written, allowing block reads or writes of successive registers.

To read a register, the MAP has to be set to the correct address by executing a partial write cycle that finishes ( $\overline{CS}$  high) immediately after the MAP byte. The MAP auto-increment bit (INCR) may be set or not, as desired. To begin a read, bring  $\overline{CS}$  low, send out the chip address and set the read/write bit (R/ $\overline{W}$ ) high. The next falling edge of CCLK will clock out the MSB of the addressed register (CDOUT will leave the high impedance state). If the MAP auto-increment bit is set to 1, the data for successive registers will appear consecutively



MAP = Memory Address Pointer, 8 bits, MSB first

**Figure 16. SPI Format**

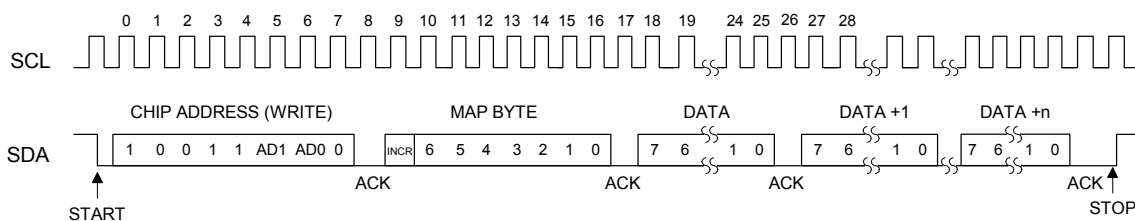
### 4.13.2 I<sup>2</sup>C Mode

In I<sup>2</sup>C Mode, SDA is a bidirectional data line. Data is clocked into and out of the part by the clock, SCL. There is no CS pin. Pins AD0 and AD1 form the two least-significant bits of the chip address and should be connected through a resistor to VLC or DGND, as desired. The state of the pins is latched when the CS5366 is being released from RST.

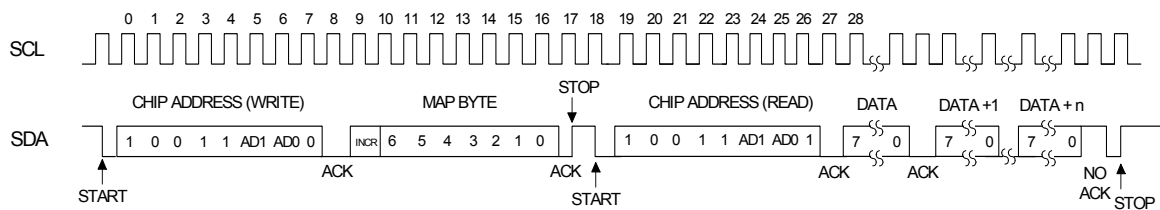
A Start condition is defined as a falling transition of SDA while SCL is high. A Stop condition is a rising transition of SDA while SCL is high. All other transitions of SDA occur while SCL is low. The first byte sent to the CS5366 after a Start condition consists of a 7-bit chip address field and a R/W bit (high for a read, low for a write). The upper five bits of the 7-bit address field are fixed at 10011. To communicate with a CS5366, the chip address field, which is the first byte sent to the CS5366, should match 10011 and be followed by the settings of the AD1 and AD0. The eighth bit of the address is the R/W bit. If the operation is a write, the next byte is the Memory Address Pointer (MAP), which selects the register to be read or written. If the operation is a read, the contents of the register pointed to by the MAP will be output. Setting the auto-increment bit in MAP allows successive reads or writes of consecutive registers. Each byte is separated by an acknowledge bit. The ACK bit is output from the CS5366 after each input byte is read and is input to the CS5366 from the microcontroller after each transmitted byte.

Since the read operation cannot set the MAP, an aborted write operation is used as a preamble. The write operation is aborted after the acknowledge for the MAP byte by sending a Stop condition. The following pseudocode illustrates an aborted write operation followed by a read operation.

- Send start condition.
- Send 10011xx0 (chip address & write operation).
- Receive acknowledge bit.
- Send MAP byte, auto increment off.
- Receive acknowledge bit.
- Send stop condition, aborting write.
- Send start condition.
- Send 10011xx1 (chip address & read operation).
- Receive acknowledge bit.
- Receive byte, contents of selected register.
- Send acknowledge bit.
- Send stop condition.



**Figure 17. I<sup>2</sup>C Write Format**



**Figure 18. I<sup>2</sup>C Read Format**

## 5. REGISTER MAP

In Control Port Mode, the bits in these registers are used to control all of the programmable features of the ADC. All registers above 0Ah are RESERVED.

### 5.1 Register Quick Reference

Adr	Name	7	6	5	4	3	2	1	0
00	REVI	CHIP-ID[3:0]				REVISION[3:0]			
01	GCTL	CP-EN	CLKMODE	MDIV[1:0]		DIF[1:0]		MODE[1:0]	
02	OVFL	RESERVED	RESERVED	OVFL6	OVFL5	OVFL4	OVFL3	OVFL2	OVFL1
03	OVFM	RESERVED	RESERVED	OVFM6	OVFM5	OVFM4	OVFM3	OVFM2	OVFM1
04	HPF	RESERVED	RESERVED	HPF6	HPF5	HPF4	HPF3	HPF2	HPF1
05	RESERVED	-	-	-	-	-	-	-	-
06	PDNE	RESERVED		PDN-BG	PDN-OSC	RESERVED	PDN65	PDN43	PDN21
07	RESERVED	-	-	-	-	-	-	-	-
08	MUTE	RESERVED	RESERVED	MUTE6	MUTE5	MUTE4	MUTE3	MUTE2	MUTE1
09	RESERVED	-	-	-	-	-	-	-	-
0A	SDEN	RESERVED				RESERVED	SDEN3	SDEN2	SDEN1

### 5.2 00h (REVI) Chip ID Code & Revision Register

R/W	7	6	5	4	3	2	1	0
R	CHIP-ID[3:0]				REVISION[3:0]			

Default: See description

The Chip ID Code & Revision Register is used to store the ID and revision of the chip.

Bits[7:4] contain the chip ID, where the CS5366 is represented with a value of 0x6.

Bits[3:0] contain the revision of the chip, where revision A is represented as 0x0, revision B is represented as 0x1, etc.

### 5.3 01h (GCTL) Global Mode Control Register

R/W	7	6	5	4	3	2	1	0
R/W	CP-EN	CLKMODE	MDIV[1:0]		DIF[1:0]		MODE[1:0]	

Default: 0x00

The Global Mode Control Register is used to control the Master/Slave Speed modes, the serial audio data format and the Master clock dividers for all channels. It also contains a Control Port enable bit.

**Bit[7] CP-EN** manages the Control Port Mode. Until this bit is asserted, all pins behave as if in Stand-Alone Mode. When this bit is asserted, all pins used in Stand-Alone Mode are ignored, and the corresponding register values become functional.

**Bit[6] CLKMODE** Setting this bit puts the part in 384X mode (divides XTI by 1.5), and clearing the bit invokes 256X mode (divide XTI by 1.0 - pass through).



**Bits[5:4] MDIV[1:0]** Each bit selects an XTI divider. When either bit is low, an XTI divide-by-1 function is selected. When either bit is HIGH, an XTI divide-by-2 function is selected. With both bits HIGH, XTI is divided by 4.

The table below shows the composite XTI division using both CLKMODE and MDIV[1:0].

CLKMODE,MDIV[1],MDIV[0]	DESCRIPTION
000	Divide-by-1
100	Divide-by-1.5
001 or 010	Divide-by-2
101 or 110	Divide-by-3
011	Divide-by-4
111	Reserved

**Bits[3:2] DIF[1:0]** Determine which data format the serial audio interface is using to clock-out data.

**DIF[1:0]**

- 0x00 Left-Justified format
- 0x01 I<sup>2</sup>S format
- 0x02 TDM
- 0x03 Reserved

**Bits[1:0] MODE[1:0]** This bit field determines the device sample rate range and whether it is operating as an audio clocking Master or Slave.

**MODE[1:0]**

- 0x00 Single-Speed Mode Master
- 0x01 Double-Speed Mode Master
- 0x02 Quad-Speed Mode Master
- 0x03 Slave Mode all speeds

#### 5.4 02h (OVFL) Overflow Status Register

R/W	7	6	5	4	3	2	1	0
R	RESERVED	RESERVED	OVFL6	OVFL5	OVFL4	OVFL3	OVFL2	OVFL1

Default: 0xFF, no overflows have occurred.

**Note:** This register interacts with Register 03h, the Overflow Mask Register.

The Overflow Status Register is used to indicate an individual overflow in a channel. If an overflow condition on any channel is detected, the corresponding bit in this register is asserted (low) in addition to the open drain active low OVFL pin going low. Each overflow status bit is sticky and is cleared only when read, providing full interrupt capability.

#### 5.5 03h (OVFM) Overflow Mask Register

R/W	7	6	5	4	3	2	1	0
R/W	RESERVED	RESERVED	OVFM6	OVFM5	OVFM4	OVFM3	OVFM2	OVFM1

Default: 0xFF, all overflow interrupts enabled.

The Overflow Mask Register is used to allow or prevent individual channel overflow events from creating activity on the OVFL pin. When a particular bit is set low in the Mask register, the corresponding overflow bit in the Overflow Status register is prevented from causing any activity on the OVFL pin.

## 5.6 04h (HPF) High-Pass Filter Register

R/W	7	6	5	4	3	2	1	0
R/W	RESERVED	RESERVED	HPF6	HPF5	HPF4	HPF3	HPF2	HPF1

Default: 0x00, all high-pass filters enabled.

The High-Pass Filter Register is used to enable or disable a high-pass filter that exists for each channel. These filters are used to perform DC offset calibration, a procedure that is detailed in [“DC Offset Control” on page 29](#).

## 5.7 05h Reserved

R/W	7	6	5	4	3	2	1	0
RESERVED	-	-	-	-	-	-	-	-

## 5.8 06h (PDN) Power Down Register

R/W	7	6	5	4	3	2	1	0
R/W	RESERVED		PDN-BG	PDN-OSC	RESERVED	PDN65	PDN43	PDN21

Default: 0x00 - everything powered up

The Power Down Register is used as needed to reduce the chip’s power consumption.

**Bit[7] RESERVED**

**Bit[6] RESERVED**

**Bit[5] PDN-BG** When set, this bit powers-down the bandgap reference.

**Bit[4] PDN-OSC** controls power to the internal oscillator core. When asserted, the internal oscillator core is shut down, and no clock is supplied to the chip. If the chip is running off an externally supplied clock at the MCLK pin, it is also prevented from clocking the device internally.

**Bit[2:0] PDN** When any bit is set, all clocks going to a channel pair are turned off, and the serial data outputs are forced to all zeroes.

## 5.9 07h Reserved

R/W	7	6	5	4	3	2	1	0
RESERVED	-	-	-	-	-	-	-	-

## 5.10 08h (MUTE) Mute Control Register

R/W	7	6	5	4	3	2	1	0
R/W	RESERVED	RESERVED	MUTE6	MUTE5	MUTE4	MUTE3	MUTE2	MUTE1

Default: 0x00, no channels are muted.

The Mute Control Register is used to mute or unmute the serial audio data output of individual channels. When a bit is set, that channel’s serial data is muted by forcing the output to all zeroes.

**5.11 09h Reserved**

R/W	7	6	5	4	3	2	1	0
RESERVED	-	-	-	-	-	-	-	-

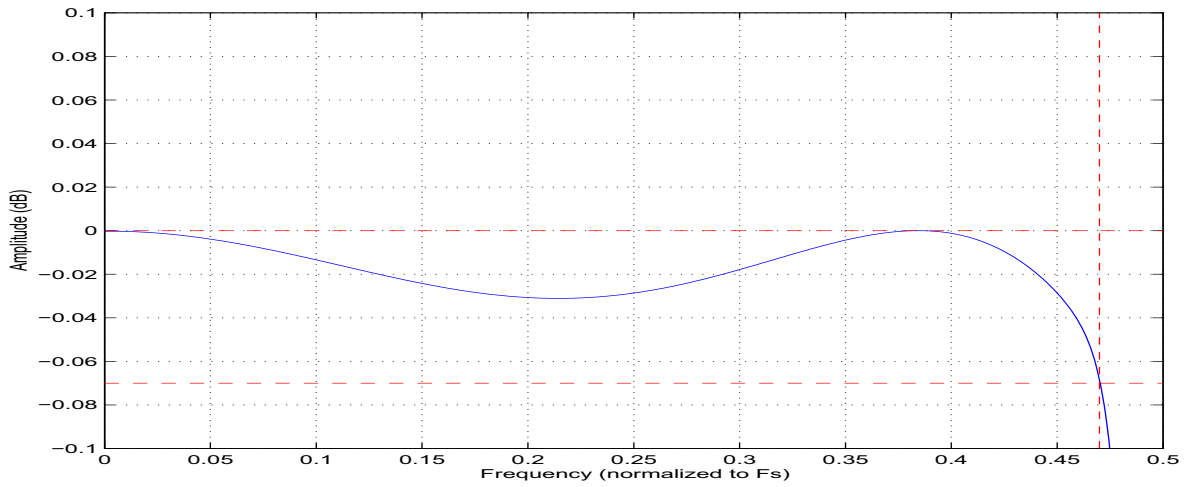
**5.12 0Ah (SDEN) SDOOUT Enable Control Register**

R/W	7	6	5	4	3	2	1	0
R/W	RESERVED				RESERVED	SDEN3	SDEN2	SDEN1

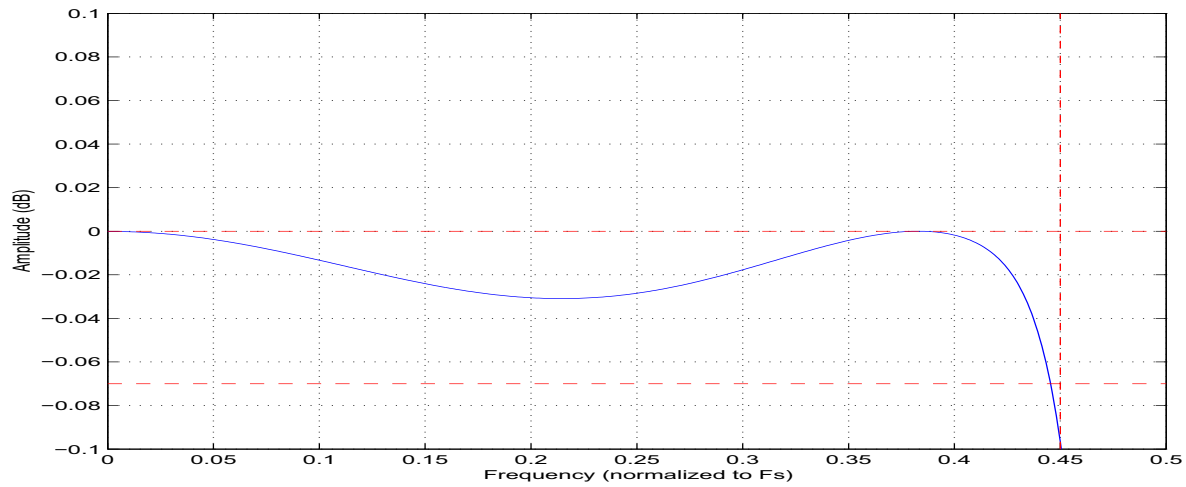
Default: 0x00, all SDOOUT pins enabled.

The SDOOUT Enable Control Register is used to tri-state the serial audio data output pins. Each bit, when set, tri-states the associated SDOOUT pin.

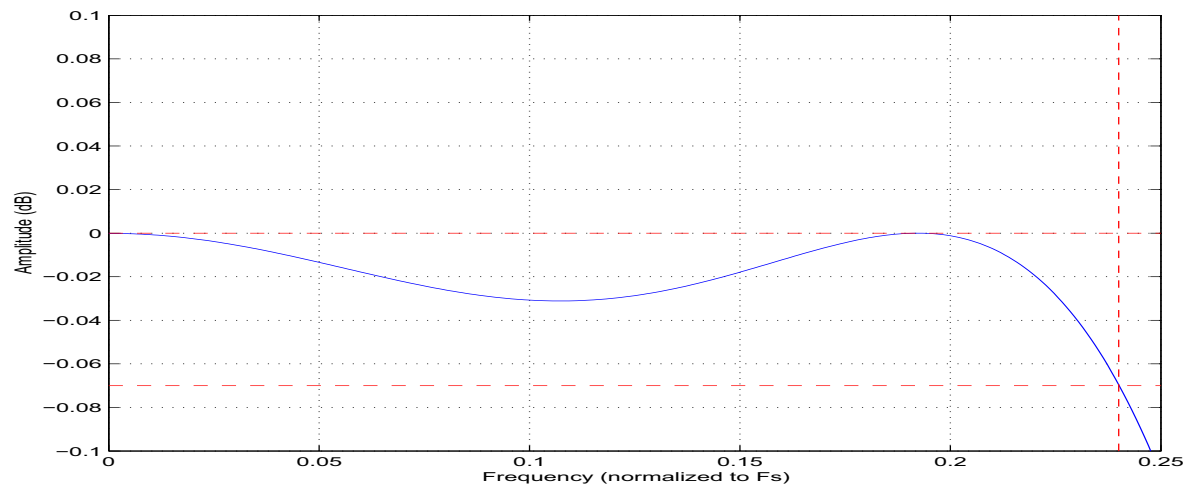
## 6. FILTER PLOTS



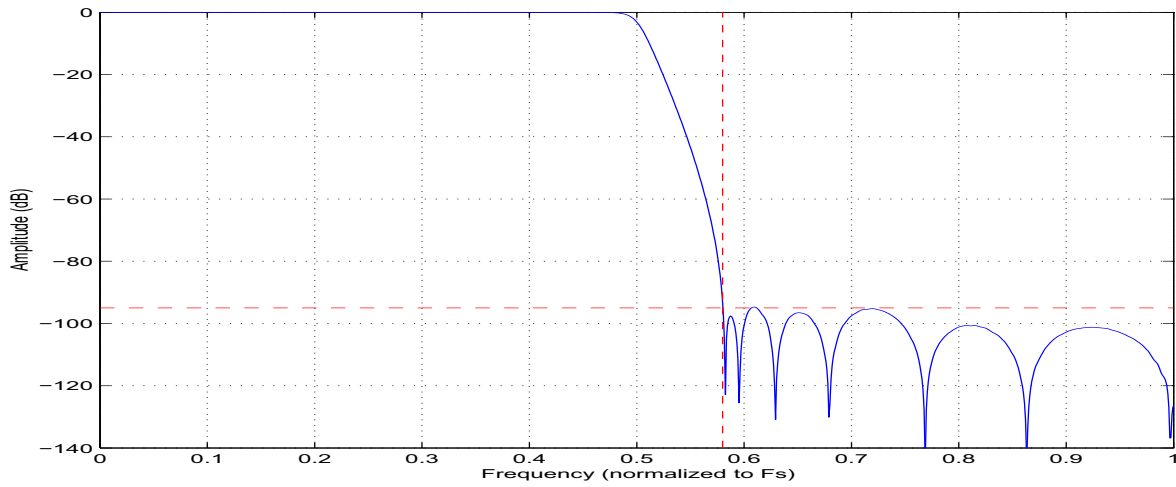
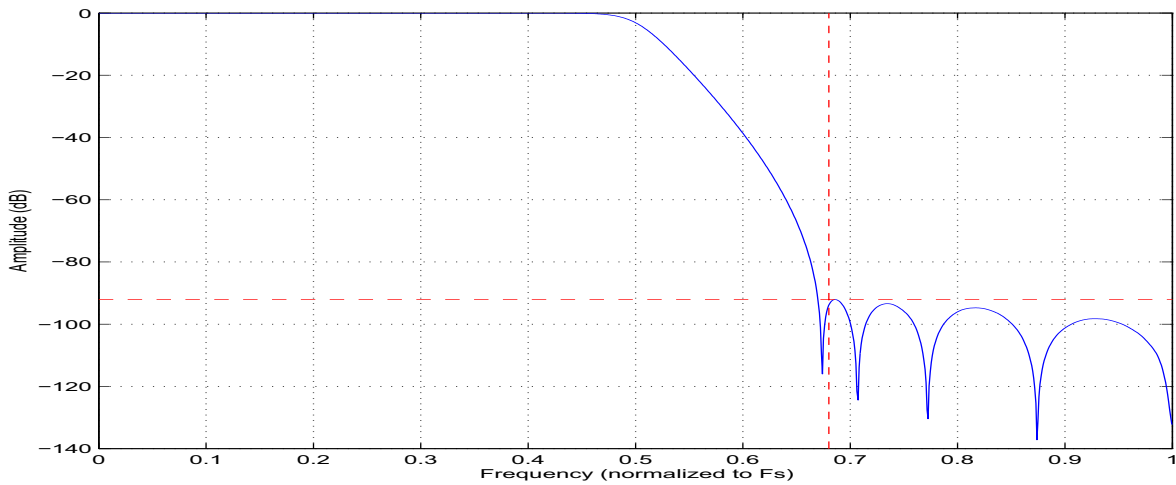
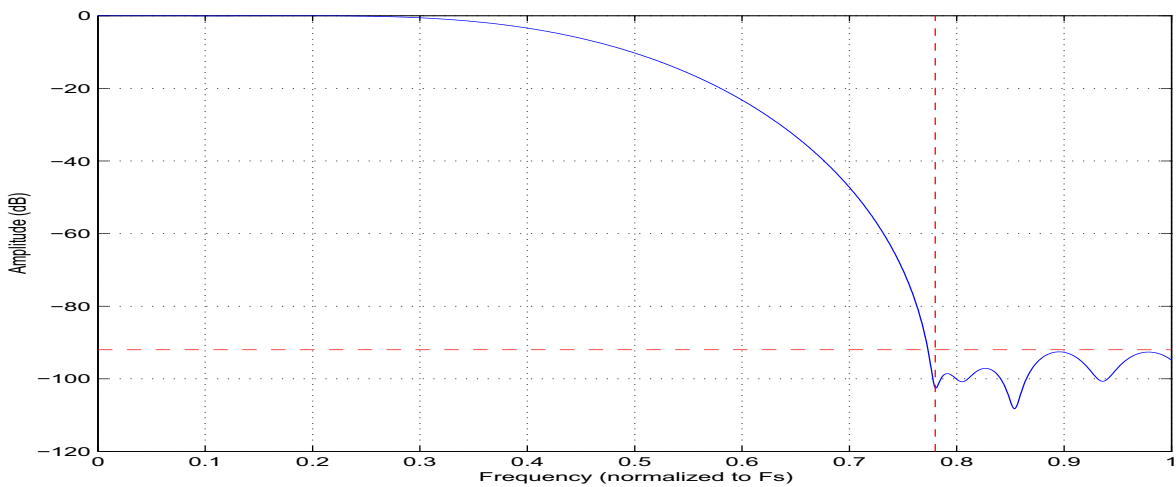
**Figure 19. SSM Passband**

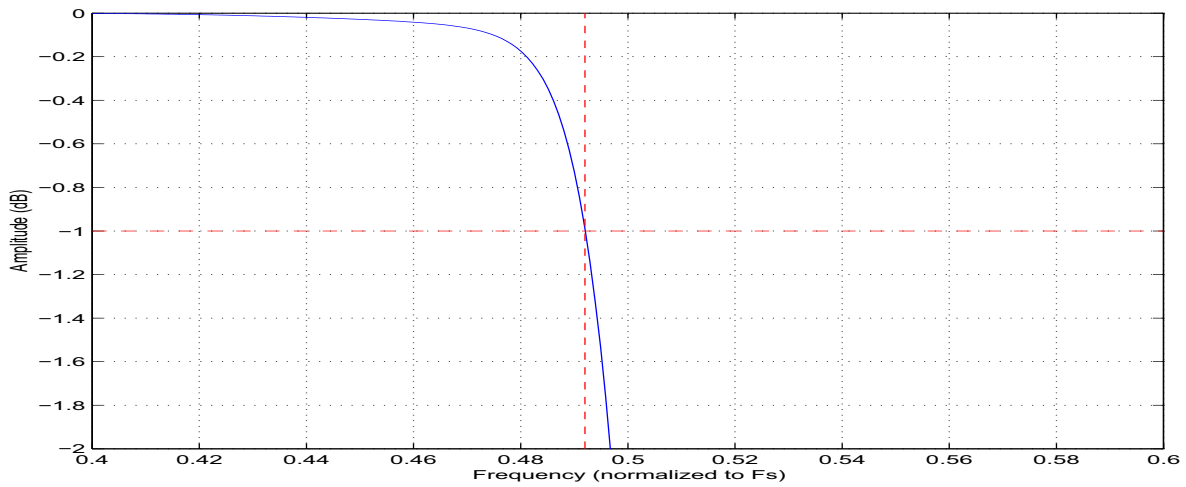


**Figure 20. DSM Passband**

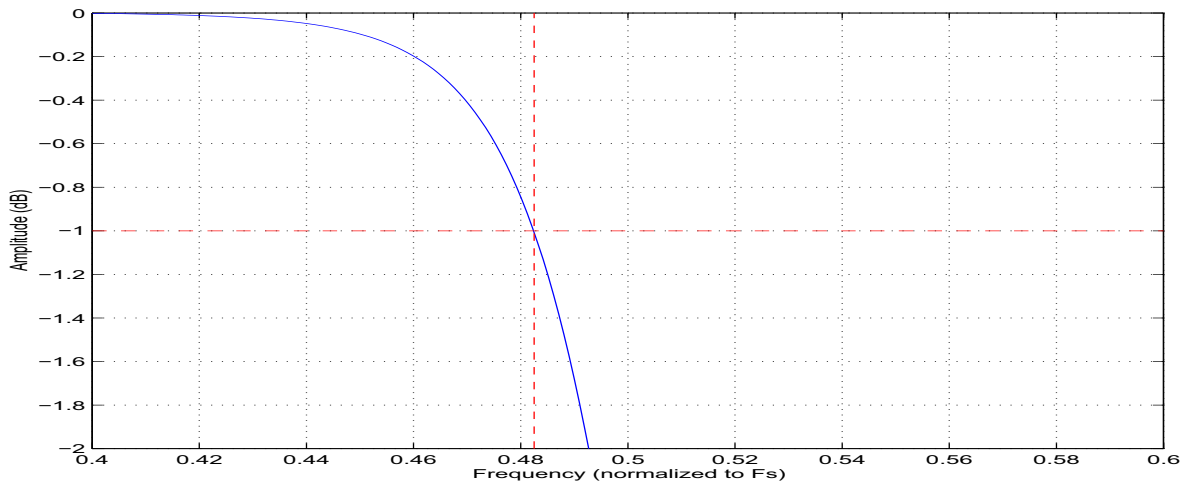


**Figure 21. QSM Passband**

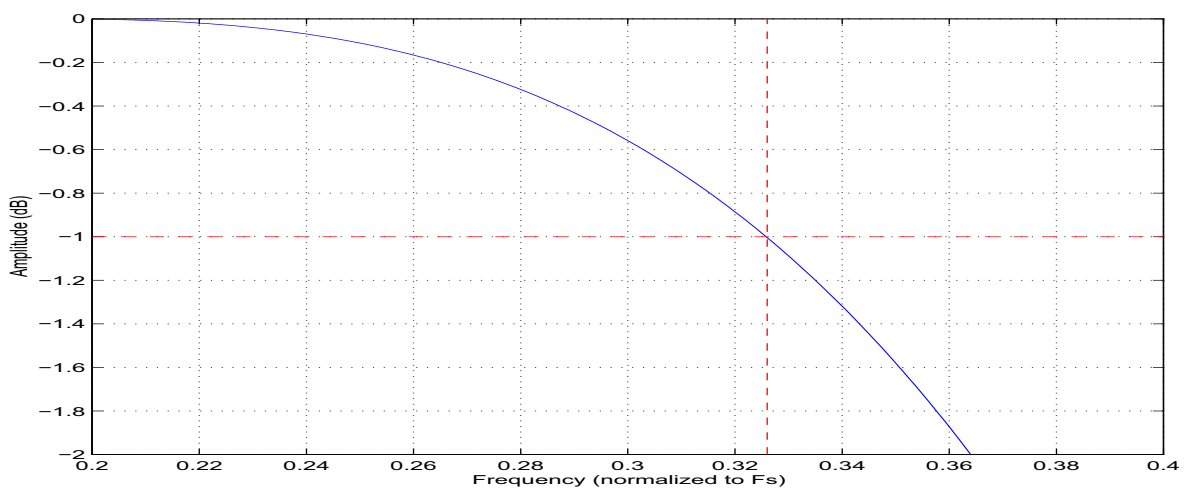

**Figure 22. SSM Stopband**

**Figure 23. DSM Stopband**

**Figure 24. QSM Stopband**



**Figure 25. SSM -1 dB Cutoff**



**Figure 26. DSM -1 dB Cutoff**



**Figure 27. QSM -1 dB Cutoff**

---

## 7. PARAMETER DEFINITIONS

### Dynamic Range

The ratio of the rms value of the signal to the rms sum of all other spectral components over the specified bandwidth. Dynamic Range is a signal-to-noise ratio measurement over the specified bandwidth made with a -60 dBFS signal. 60 dB is added to resulting measurement to refer the measurement to full scale. This technique ensures that the distortion components are below the noise level and do not affect the measurement. This measurement technique has been accepted by the Audio Engineering Society, AES17-199, and the Electronic Industries Association of Japan, EIAJ CP-307. Expressed in decibels. The dynamic range is specified with and without an A-weighting filter.

### Total Harmonic Distortion + Noise

The ratio of the rms value of the signal to the rms sum of all other spectral components over the specified bandwidth (typically 10 Hz to 20 kHz), including distortion components. Expressed in decibels. Measured at -1 and -20 dBFS as suggested in AES17-1991 Annex A. Specified using an A-weighting filter.

### Frequency Response

A measure of the amplitude response variation from 10 Hz to 20 kHz relative to the amplitude response at 1 kHz. Units in decibels.

### Interchannel Isolation

A measure of crosstalk between one channel and all remaining channels, measured for each channel at the converter's output with no signal to the input under test and a full-scale signal applied to all other channels. Units in decibels.

### Interchannel Gain Mismatch

The gain difference between left and right channels. Units in decibels.

### Gain Error

The deviation from the nominal full-scale analog output for a full-scale digital input.

### Gain Drift

The change in gain value with temperature. Units in ppm/°C.

### Offset Error

The deviation of the mid-scale transition (111...111 to 000...000) from the ideal. Units in mV.

### Intrachannel Phase Deviation

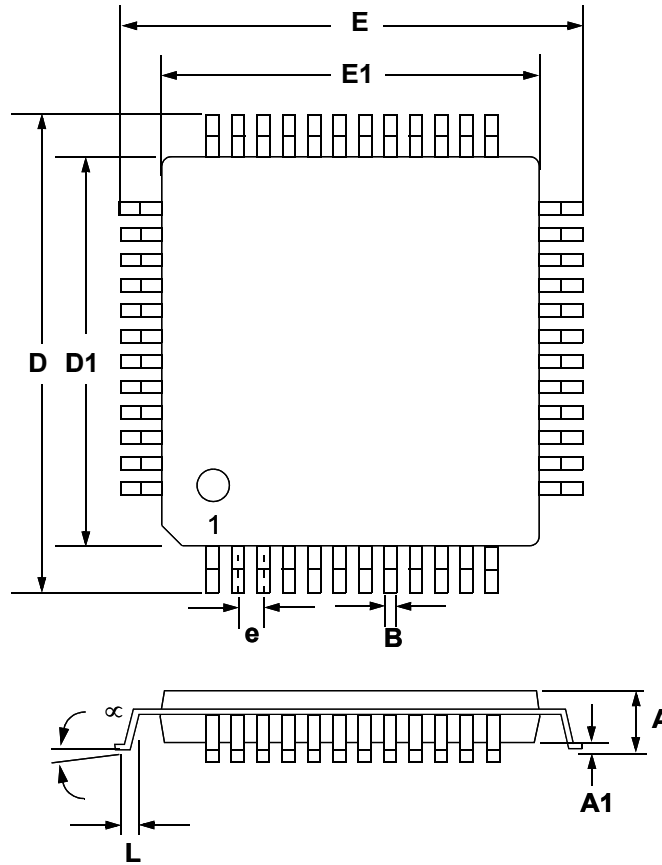
The deviation from linear phase within a given channel.

### Interchannel Phase Deviation

The difference in phase response between channels.

## 8. PACKAGE DIMENSIONS

### 48L LQFP PACKAGE DRAWING



DIM	INCHES			MILLIMETERS		
	MIN	NOM	MAX	MIN	NOM	MAX
A	---	0.055	0.063	---	1.40	1.60
A1	0.002	0.004	0.006	0.05	0.10	0.15
B	0.007	0.009	0.011	0.17	0.22	0.27
D	0.343	0.354	0.366	8.70	9.0 BSC	9.30
D1	0.272	0.28	0.280	6.90	7.0 BSC	7.10
E	0.343	0.354	0.366	8.70	9.0 BSC	9.30
E1	0.272	0.28	0.280	6.90	7.0 BSC	7.10
e*	0.016	0.020	0.024	0.40	0.50 BSC	0.60
L	0.018	0.24	0.030	0.45	0.60	0.75
$\alpha$	0.000°	4°	7.000°	0.00°	4°	7.00°

\* Nominal pin pitch is 0.50 mm

Controlling dimension is mm. JEDEC Designation: MS026

## THERMAL CHARACTERISTICS

Parameter	Symbol	Min	Typ	Max	Unit
Allowable Junction Temperature		-	-	135	°C
Package Thermal Resistance	$\theta_{JA}$	-	48	-	°C/W
	$\theta_{JC}$	-	15	-	



## 9. ORDERING INFORMATION

Product	Description	Package	Pb-Free	Grade	Temp Range	Container	Order #
CS5366	114 dB, 192 kHz, 6-channel A/D Converter	48-pin LQFP	YES	Commercial	-40°C to +85°C	Tray	CS5366-CQZ
						Tape & Reel	CS5366-CQZR
				Automotive	-40°C to +105°C	Tray	CS5366-DQZ
						Tape & Reel	CS5366-DQZR
CDB5366	Evaluation Board for CS5366						CDB5366

## 10. REVISION HISTORY

Revision	Changes
F1 DEC '06	Initial release.
F2 JUL '07	Updated the wording of pin 24, LRCK/FS, in the pin description table on page 7 to correctly reflect the high/low clocking state for odd-channel c in I <sup>2</sup> S and LJ Modes.
F3 JAN '08	Corrected SCL/CCLK pin description (Pin 39) for " <a href="#">Control Port Mode</a> " on page 8.
F4 APR '09	Corrected Absolute Max temp for " <a href="#">Ambient Operating Temperature (Power Applied)</a> " on page 10.
F5 JUL '14	Updated I <sup>2</sup> C and SPI bullet under " <a href="#">Additional Control Port Features</a> " on page 1. Added Note 2 to " <a href="#">Switching Specifications - Control Port - I<sup>2</sup>C Timing</a> " on page 17.

---

## Contacting Cirrus Logic Support

For all product questions and inquiries, contact a Cirrus Logic Sales Representative.

To find the one nearest you, go to [www.cirrus.com](http://www.cirrus.com).

---

### IMPORTANT NOTICE

Cirrus Logic, Inc. and its subsidiaries ("Cirrus") believe that the information contained in this document is accurate and reliable. However, the information is subject to change without notice and is provided "AS IS" without warranty of any kind (express or implied). Customers are advised to obtain the latest version of relevant information to verify, before placing orders, that information being relied on is current and complete. All products are sold subject to the terms and conditions of sale supplied at the time of order acknowledgment, including those pertaining to warranty, indemnification, and limitation of liability. No responsibility is assumed by Cirrus for the use of this information, including use of this information as the basis for manufacture or sale of any items, or for infringement of patents or other rights of third parties. This document is the property of Cirrus and by furnishing this information, Cirrus grants no license, express or implied under any patents, mask work rights, copyrights, trademarks, trade secrets or other intellectual property rights. Cirrus owns the copyrights associated with the information contained herein and gives consent for copies to be made of the information only for use within your organization with respect to Cirrus integrated circuits or other products of Cirrus. This consent does not extend to other copying such as copying for general distribution, advertising or promotional purposes, or for creating any work for resale.

CERTAIN APPLICATIONS USING SEMICONDUCTOR PRODUCTS MAY INVOLVE POTENTIAL RISKS OF DEATH, PERSONAL INJURY, OR SEVERE PROPERTY OR ENVIRONMENTAL DAMAGE ("CRITICAL APPLICATIONS"). CIRRUS PRODUCTS ARE NOT DESIGNED, AUTHORIZED OR WARRANTED FOR USE IN PRODUCTS SURGICALLY IMPLANTED INTO THE BODY, AUTOMOTIVE SAFETY OR SECURITY DEVICES, LIFE SUPPORT PRODUCTS OR OTHER CRITICAL APPLICATIONS. INCLUSION OF CIRRUS PRODUCTS IN SUCH APPLICATIONS IS UNDERSTOOD TO BE FULLY AT THE CUSTOMER'S RISK AND CIRRUS DISCLAIMS AND MAKES NO WARRANTY, EXPRESS, STATUTORY OR IMPLIED, INCLUDING THE IMPLIED WARRANTIES OF MERCHANTABILITY AND FITNESS FOR PARTICULAR PURPOSE, WITH REGARD TO ANY CIRRUS PRODUCT THAT IS USED IN SUCH A MANNER. IF THE CUSTOMER OR CUSTOMER'S CUSTOMER USES OR PERMITS THE USE OF CIRRUS PRODUCTS IN CRITICAL APPLICATIONS, CUSTOMER AGREES, BY SUCH USE, TO FULLY INDEMNIFY CIRRUS, ITS OFFICERS, DIRECTORS, EMPLOYEES, DISTRIBUTORS AND OTHER AGENTS FROM ANY AND ALL LIABILITY, INCLUDING ATTORNEYS' FEES AND COSTS, THAT MAY RESULT FROM OR ARISE IN CONNECTION WITH THESE USES.

Cirrus Logic, Cirrus, and the Cirrus Logic logo designs are trademarks of Cirrus Logic, Inc. All other brand and product names in this document may be trademarks or service marks of their respective owners.

SPI is a trademark of Motorola, Inc.

## X-ON Electronics

Largest Supplier of Electrical and Electronic Components

*Click to view similar products for [Audio A/D Converter ICs](#) category:*

*Click to view products by [Cirrus](#) manufacturer:*

Other Similar products are found below :

[WM8781GEDSV](#) [WM8788GEDT](#) [WM8782SEDSV](#) [CS5346-CQZR](#) [CS4461-CZZ](#) [WM8782ASEDS/RV](#) [AD1877JRZ](#) [AD1974WBSTZ](#)  
[ADAU1977WBCPZ](#) [ADAU7112ACBZR7](#) [ADAU7118ACPZRL](#) [ADAU1979WBCPZ-RL](#) [CS5345-CQZ](#) [WM8950CGEFL/V](#) [CS5340-CZZ](#)  
[CS5340-DZZ](#) [CS5341-CZZ](#) [CS5342-CZZ](#) [CS5344-CZZ](#) [CS5346-CQZ](#) [CS5351-DZZ](#) [CS5361-KSZ](#) [CS5361-KZZ](#) [CS5364-DQZ](#) [CS5381-](#)  
[KSZ](#) [CS5381-KZZ](#) [CS53L21-CNZ](#) [CS53L30-CNZ](#) [WM8782ASEDS/V](#) [WM8786GEDS/RV](#) [6PADC3101TRGERQ1](#) [PCM1800E](#)  
[PCM1801U](#) [PCM1803ADB](#) [PCM1803ADBG4](#) [PCM1804DB](#) [PCM1804DBG4](#) [PCM1804DBR](#) [PCM1804S1IDBRQ1](#) [PCM1807PW](#)  
[PCM1807PWR](#) [PCM1808PW](#) [PCM1808PWG4](#) [PCM1808PWRG4](#) [PCM1851APJT](#) [PCM1851APJTR](#) [PCM1861DBT](#) [PCM1862DBTR](#)  
[PCM1864DBT](#) [PCM1865DBT](#)