

AT-CUT CRYSTAL UNIT (SMD · Ceramic Package)

RoHS compliant / Pb free

CS325S

3,000pcs/reel

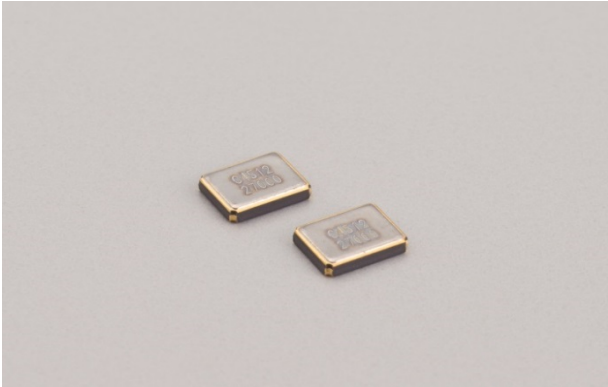

■ FEATURES

- Ultra-lightweight microminiature AT Crystal units SMD type
- Frequency range : 12.0 ~ 54.0MHz
- External dimensions (mm)
L : 3.3 x W : 2.6 x H : 0.7
- Applications
Small mobile devices / Consumer products

■ DIMENSION [mm]

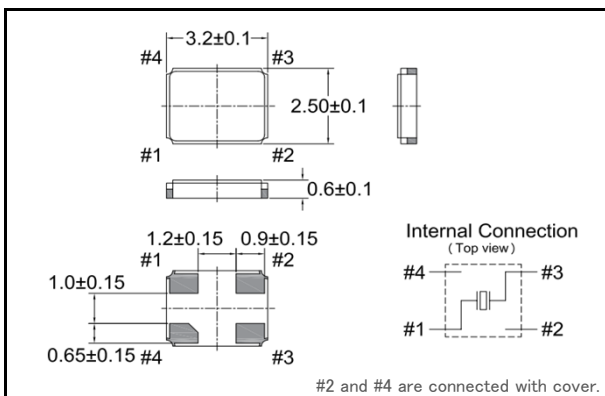

■ SOLDER PAD LAYOUT [mm]

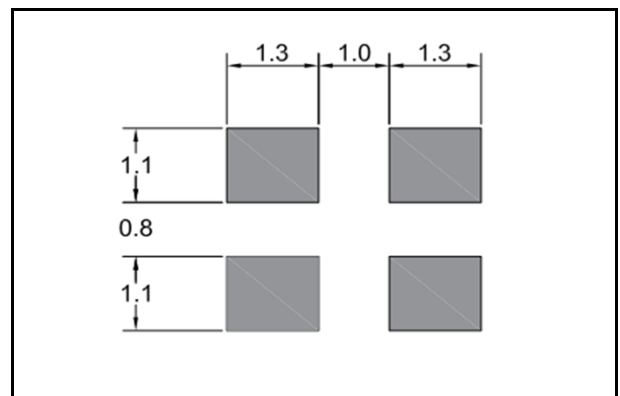

■ STANDARD SPECIFICATIONS

Item	Model	CS325S	Conditions
Nominal Frequency	f_0	12.0MHz ~ 54.0MHz (Fundamental)	Please contact us for frequencies available
Frequency Tolerance	$\Delta f/f_0$	±30ppm	at 25°C
Frequency Tolerance over Operating Temperature Range	$\Delta f/f_0$	±30ppm	-10°C ~ +60°C
Operating Temperature Range	T_{OPR}	-40°C ~ +85°C	
Storage Temperature Range	T_{STR}	-55°C ~ +125°C	
Motional (series) resistance	R_1	Refer to the following table	at 25°C
Load capacitance	C_L	10.0pF ~ ∞	Please specify your requirement
Shunt capacitance	C_0	5.0pF Max.	
Level of drive	DL	100 μW Max.	
Insulation Resistance	I_R	500MΩ Min.	DC100V ± 15V
Aging (first year)	$\Delta f/f_0$	±5ppm Max.	25°C ± 3°C

■ MOTIONAL (SERIES) RESISTANCE (R1)

Freq. Range (MHz)	$12.0 \leq f_0 < 16.0$	$16.0 \leq f_0 < 20.0$	$20.0 \leq f_0 < 30.0$	$30.0 \leq f_0 < 54.0$
R_1	150 Ω Max.	120 Ω Max.	80 Ω Max.	50 Ω Max.

■ PART NUMBERING SYSTEM

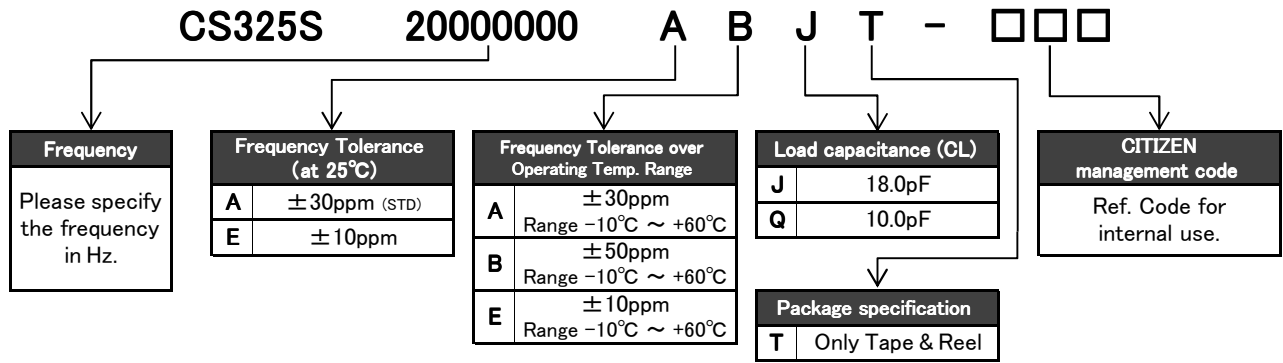

*Please contact us for specifications available.

■ Part Marking [standard]



C : Manufacture's ID Code

y : The last digit of production year

m : Production month (See Table.1)

: Production Lot No.

f : The first 4 digits of Frequency including the decimal point

Table.1

Month	Jan	Feb	...	Sep	Oct	Nov	Dec
Code	1	2	...	9	X	Y	Z

■ Reflow profile

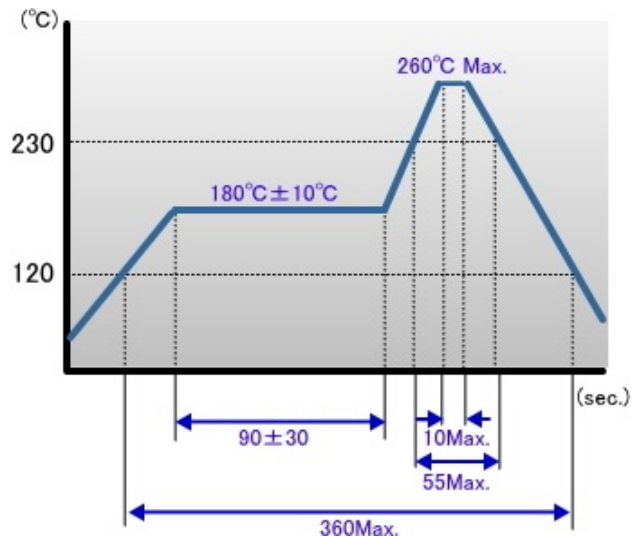

■ Packing

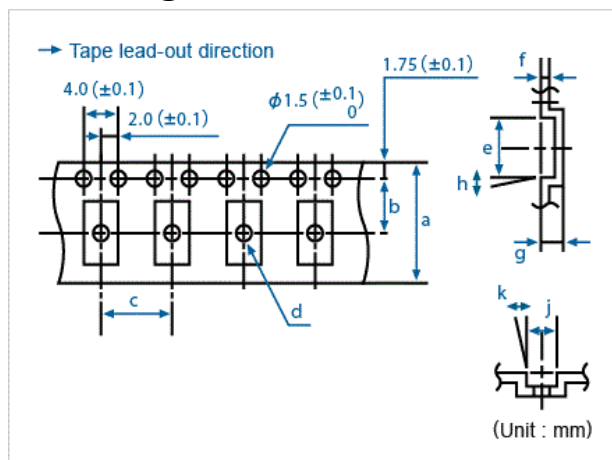

Conforming to JIS C 0806 TB1208NEIAJ and RC-1009B TE1208N

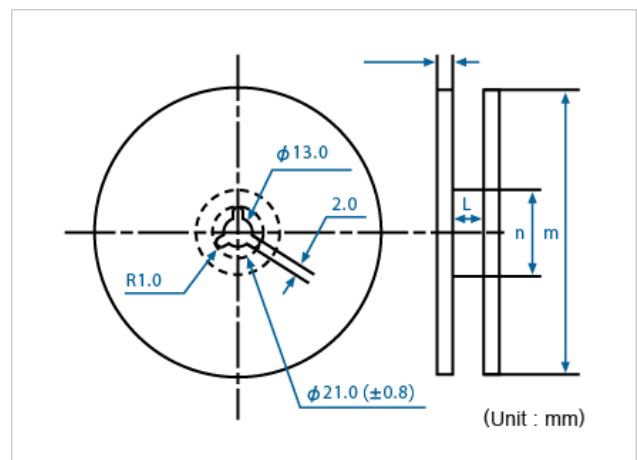

Conforming to JIS C 0806 R12R and EIAJ RC-1009B R15

Q'ty/reel	a	b	c	d (φ)	e	f	g	h	j	k	l	m (φ)	n (φ)
3,000	8.0	3.5	4.0	1.1	3.5	0.25	0.75	5°	2.8	-	11.4	180	60

Rev.1

X-ON Electronics

Largest Supplier of Electrical and Electronic Components

Click to view similar products for [Crystals](#) category:

Click to view products by [CITIZEN](#) manufacturer:

Other Similar products are found below :

[MC405 32.0000K-R3:PURE SN](#) [7A-40.000MAAE-T](#) [MP1-8.0](#) [99-BU](#) [9B-15.360MBBK-B](#) [PTX-A2JM-10.000M](#) [9C-7.680MBBK-T](#) [H10S-12.000-18-EXT-TR](#) [AB-11.0592MHZ](#) [R38-32.768-12.5-5PPM-NPB](#) [BTD1062E05A-513](#) [C711980XFAS30XX](#) [21U15A-21.4MHZ](#) [RTX-781DF1-S-20.950](#) [LFXTAL066198Cutt](#) [9C-14.31818MBBK-T](#) [A-11.000MHZ-27](#) [SPT2A-.032768B](#) [SPT2A.032768G](#) [SSPT7F-9PF20-R](#) [FX325BS-38.88EEM1201](#) [MP-1-25.000MHZ-3L](#) [MP-1-6.000MHZ](#) [LFXTAL065253Cutt](#) [LFXTAL066431Cutt](#) [XT9S20ANA14M7456](#) [XT9SNLANA16M](#) [646G-24-2](#) [7A-24.576MBBK-T](#) [7B-30.000MBBK-T](#) [7A-14.31818MBBK-T](#) [6526-202-1501](#) [BTJ120E02C](#) [SG636PCE-20.000MC](#) [ABM3B-10.000MHZ-K-T](#) [3404](#) [CM315D32768EZFT](#) [C1E-24.000-7-2020-R](#) [C1E-19.200-12-1530-X-R](#) [C1E-16.000-12-1530-X-R](#) [ABM11-16.000MHZ-9-B1U-T](#) [FL5000014](#) [EUCA18-3.1872M](#) [425F35E027M0000](#) [17196](#) [MS3V-T1R-32.768kHz-7pF-20PPM-TA-QC-Au](#) [VXM7-1C1-16M000](#) [MS1V-T1K-32.768kHz-10pF-20PPM-TA-QC-Au](#) [MS3V-T1R-32.768kHz-9pF-20PPM-TA-QC-Au](#) [ECS-80-18-30-JGN-TR](#)