

AT-CUT CRYSTAL UNIT (SMD · Ceramic Package)

RoHS compliant / Pb free

CS325S

3,000pcs/reel

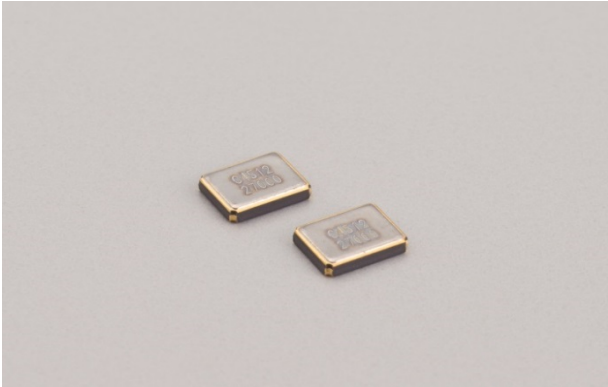

■ FEATURES

- Ultra-lightweight microminiature AT Crystal units SMD type
- Frequency range : 12.0 ~ 54.0MHz
- External dimensions (mm)
L : 3.3 x W : 2.6 x H : 0.7
- Applications
Small mobile devices / Consumer products

■ DIMENSION [mm]

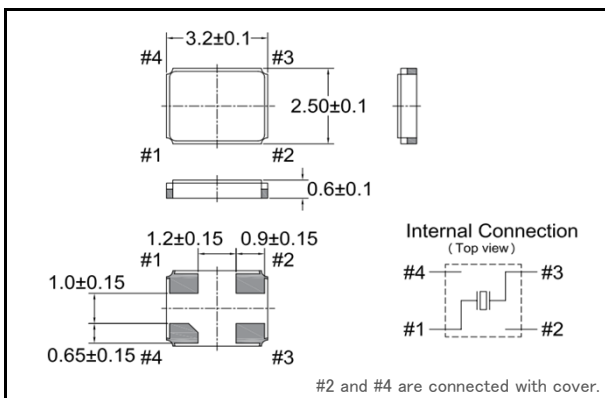

■ SOLDER PAD LAYOUT [mm]

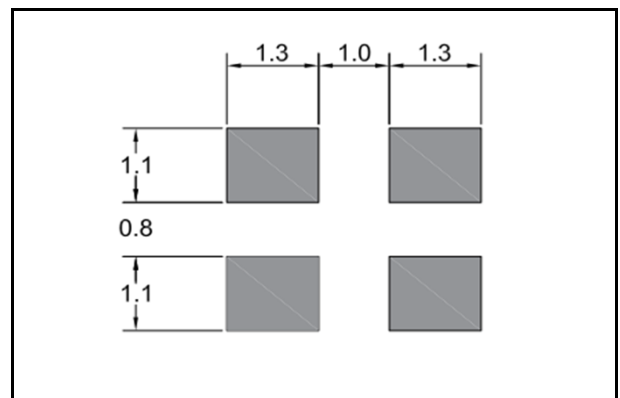

■ STANDARD SPECIFICATIONS

Item	Model	CS325S	Conditions
Nominal Frequency	f_0	12.0MHz ~ 54.0MHz (Fundamental)	Please contact us for frequencies available
Frequency Tolerance	$\Delta f/f_0$	±30ppm	at 25°C
Frequency Tolerance over Operating Temperature Range	$\Delta f/f_0$	±30ppm	-10°C ~ +60°C
Operating Temperature Range	T_{OPR}	-40°C ~ +85°C	
Storage Temperature Range	T_{STR}	-55°C ~ +125°C	
Motional (series) resistance	R_1	Refer to the following table	at 25°C
Load capacitance	C_L	10.0pF ~ ∞	Please specify your requirement
Shunt capacitance	C_0	5.0pF Max.	
Level of drive	DL	100 μW Max.	
Insulation Resistance	I_R	500MΩ Min.	DC100V ± 15V
Aging (first year)	$\Delta f/f_0$	±5ppm Max.	25°C ± 3°C

■ MOTIONAL (SERIES) RESISTANCE (R1)

Freq. Range (MHz)	12.0 ≤ f_0 < 16.0	16.0 ≤ f_0 < 20.0	20.0 ≤ f_0 < 30.0	30.0 ≤ f_0 < 54.0
R_1	150 Ω Max.	120 Ω Max.	80 Ω Max.	50 Ω Max.

■ PART NUMBERING SYSTEM

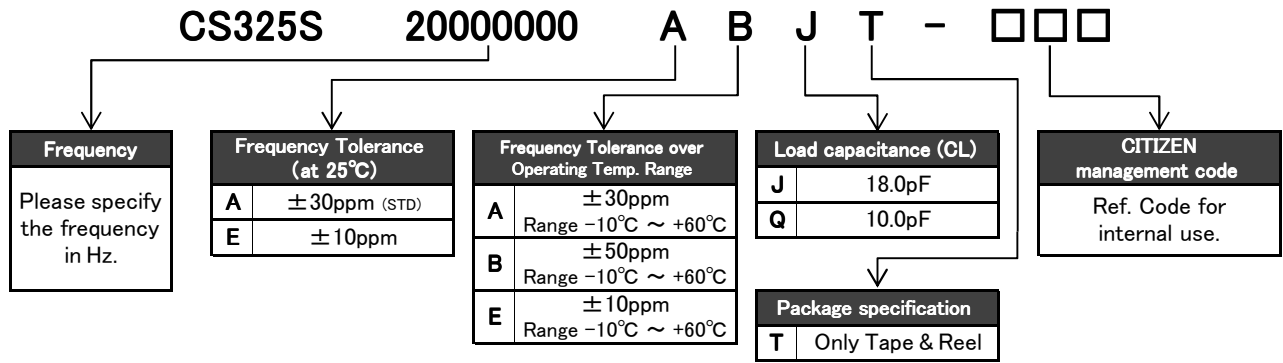

*Please contact us for specifications available.

■ Part Marking [standard]



C : Manufacture's ID Code

y : The last digit of production year

m : Production month (See Table.1)

: Production Lot No.

f : The first 4 digits of Frequency including the decimal point

Table.1

Month	Jan	Feb	...	Sep	Oct	Nov	Dec
Code	1	2	...	9	X	Y	Z

■ Reflow profile

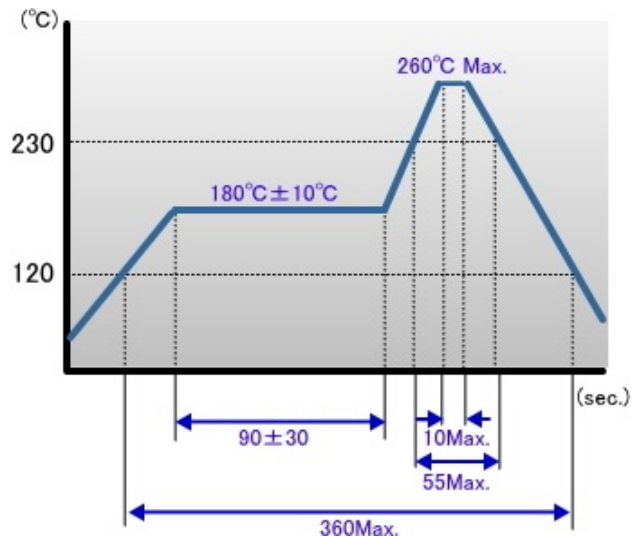

■ Packing

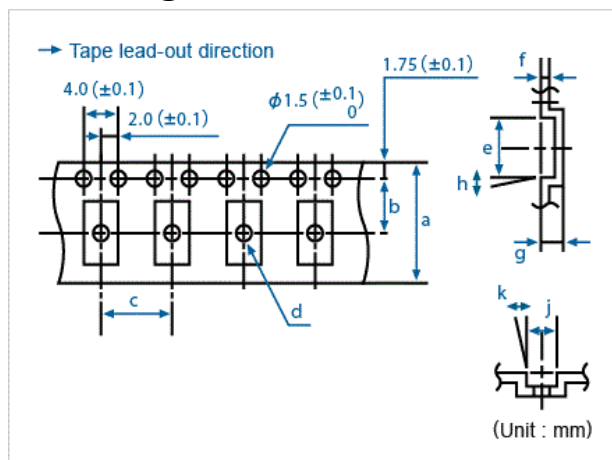

Conforming to JIS C 0806 TB1208NEIAJ and RC-1009B TE1208N

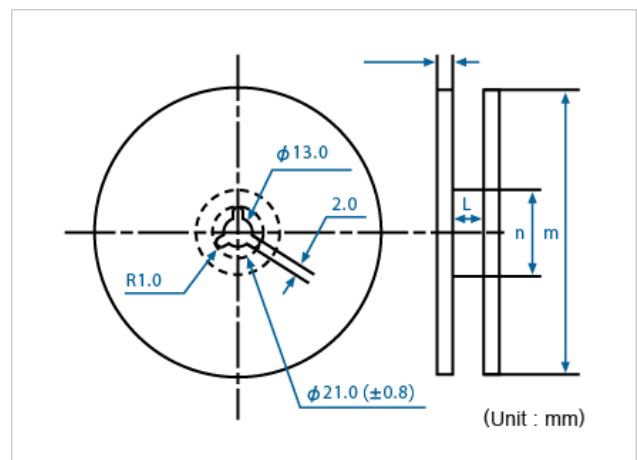

Conforming to JIS C 0806 R12R and EIAJ RC-1009B R15

Q'ty/reel	a	b	c	d (φ)	e	f	g	h	j	k	l	m (φ)	n (φ)
3,000	8.0	3.5	4.0	1.1	3.5	0.25	0.75	5°	2.8	-	11.4	180	60

Rev.1

X-ON Electronics

Largest Supplier of Electrical and Electronic Components

Click to view similar products for [CITIZEN](#) manufacturer:

Other Similar products are found below :

[CSX-750FCC4000000T](#) [CSX-750FHB12000000T](#) [HC-49/U-S24000000ABJB](#) [CS325S14318180ABJT](#) [CM315 32.768KDZY-UT](#) [HC-49/U-S4915200ABJB](#) [HCM49-7.680MABJ-UT](#) [HC49US-28.63636MABJ](#) [HCM49-18.000MABJT](#) [CSX750FJC-50.000M-UT](#) [HCM49-11.000MABJT](#) [HCM49-11.0592MABJ-UT](#) [CSX750FCC-4.000M-UT](#) [HCM493579545ABJT](#) [HCM4920000000ABJT](#) [CSX750FCC40.000M-UT](#) [CS325S28636300ABJT](#) [HC49US-6.176MABJ-UB](#) [CSX-750FCC4000000T](#) [CM309E-8.000MABJ-UT](#) [HCM498000000ABJT](#) [HCM49-48.000MABJT](#) [HC49US-6.144MABJ](#) [HCM4950000000ABJT](#) [HCM4925000000ABJT](#) [CS325S27000000ABJT](#) [HC49US-4.000MABJ-UB](#) [CMR200T32768DZFT](#) [HC49US-5.000MABJ-UB](#) [CS10-32.000MABJ-UT](#) [HC49US-9.216MABJ-UB](#) [HC49US-4.9152MABJ-UB](#) [HCM49-12.288MABJT](#) [CS325S-12000000ABJT](#) [HCM49-6.144MABJ-UT](#) [HCM49-13.500MABJ-UT](#) [HC49US-16.9344MABJ-UB](#) [HC-49/U-S6144000ABJB](#) [CM1610H32768DZFT](#) [CM51932768DZFT](#) [CSX-750FCC14745600T](#) [HC49US15.000MABJ-UB](#) [HC49US-9.000MABJ](#) [HCM4949152000ABJT](#) [HC49US-12.000MABJ-UB](#) [HCM49-5.000MABJT](#) [HC-49/U-S15000000ABJB](#) [HC49US-19.6608MABJ-UB](#) [CSX750FCC-3.6864M-UT](#) [HCM49-30.000MABJ-UT](#)