

CRYSTAL CLOCK OSCILLATORS (SMD · Ceramic Package)

RoHS compliant

CSX-750F

1,000pcs/reel

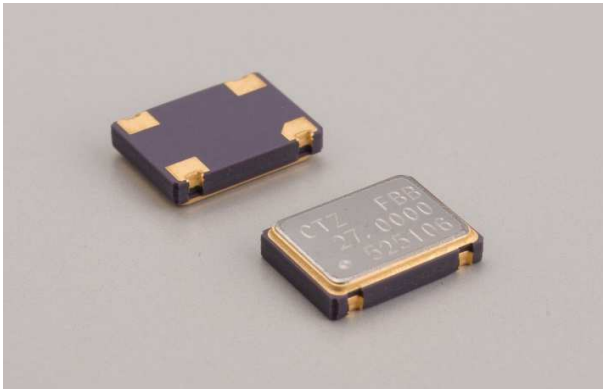

FEATURES

- Frequency range : 1.0 ~ 80.0MHz
- External dimensions (mm)
L : 7.0 x W : 5.0 x H : 1.6
- Applications
Consumer products

DIMENSION [mm]

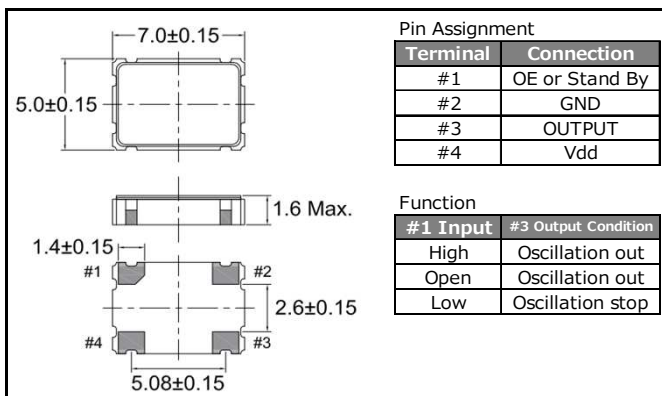

SOLDER PAD LAYOUT [mm]

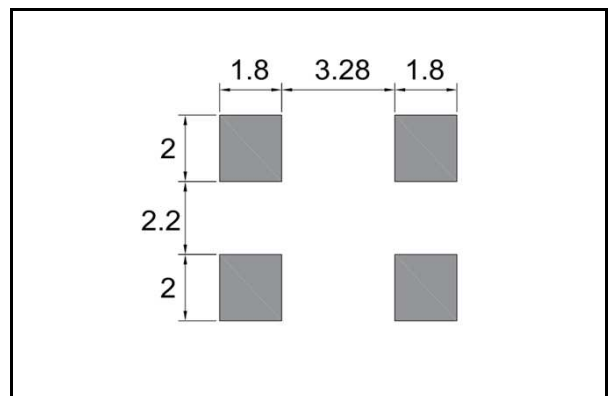

STANDARD SPECIFICATIONS

*Model is determined by selection of OE/ST functions, frequency stability, and supply voltage.

Item	Model	OE	CSX-750FC (*)		CSX-750FB (*)	CSX-750FJ (*)
		STAND-BY				
Frequency Range			1.8432~39.999MHz	40.000~75.000MHz	1.8432~39.999MHz	40.000~80.000MHz
Supply Voltage			Vdd: 5.0V±0.5V		Vdd: 3.3V±0.3V	
Frequency Stability	(*)		B: ±50ppm(-20°C ~ +70°C), C: ±100ppm(-20°C ~ +70°C) E: ±50ppm(-40°C ~ +85°C), F: ±100ppm(-40°C ~ +85°C)			
Operating Temperature Range			-20°C ~ +70°C / (-40°C ~ +85°C)			
Storage Temperature Range			-55°C ~ +125°C			
Current consumption			25mA Max.	45mA Max.	15mA Max.	25mA Max.
Duty	TTL level (1.4V)		40~60%		—	
	CMOS level (1/2 Vdd)		45~55%			
Output Voltage	V _{OH}		0.9Vdd Min.			
	V _{OL}		0.4V Max.		0.1Vdd Max.	
Output Load	TTL		10TTL Max.		—	
	CMOS		50pF Max.		30pF Max.	
Rise and Fall Time			8 nsec Max.	6 nsec Max.	8 nsec Max.	6 nsec Max.
Start-up time			4 msec Max.	10 msec Max.	4 msec Max.	10 msec Max.
Input Voltage	V _{IH}		2.0V Min.			
	V _{IL}		0.8V Max.		0.4V Max.	0.3Vdd Max.
Disable current			10mA Max.	20mA Max.	5mA Max.	—
Stand-by current			—		10 μA Max.	

■ PART NUMBERING SYSTEM

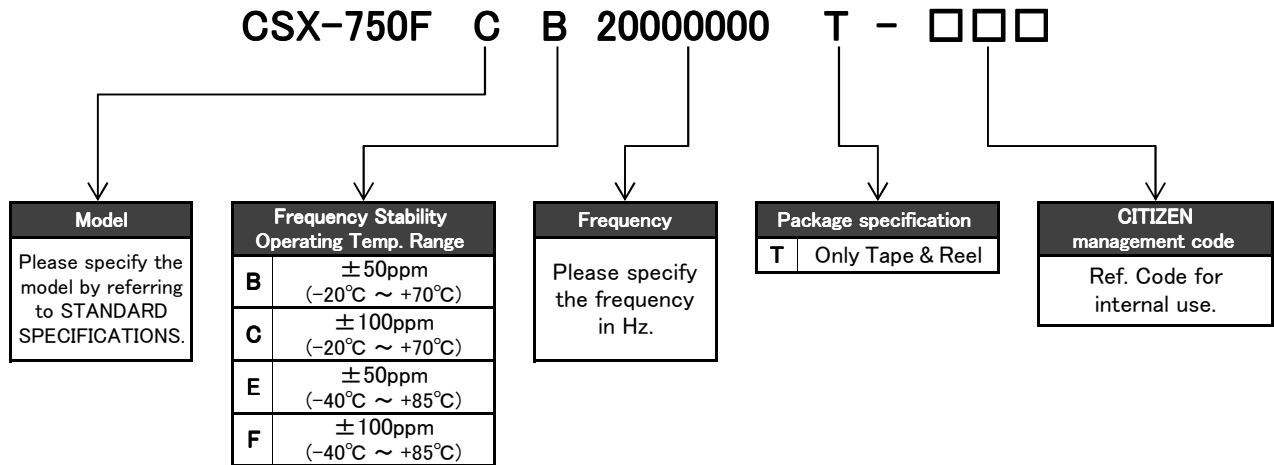

*Please contact us for specifications available.

■ Part Marking [standard]

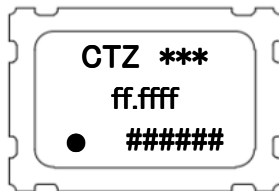

CTZ : Manufacture's ID Code

* : Model

f : Frequency

: Production Lot No.

■ Reflow profile

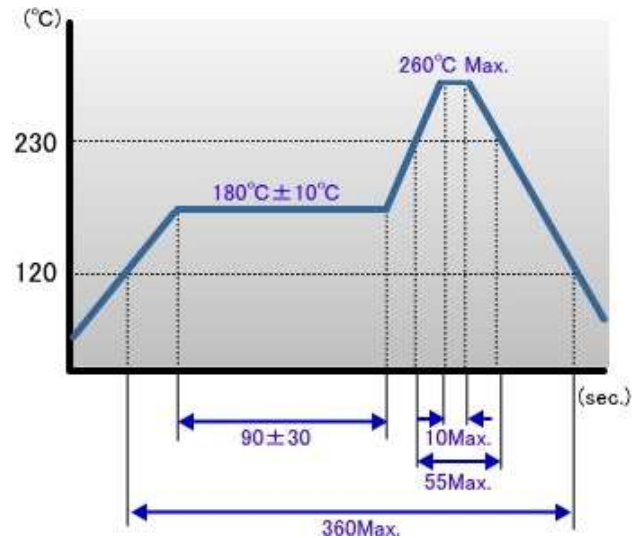

■ Packing

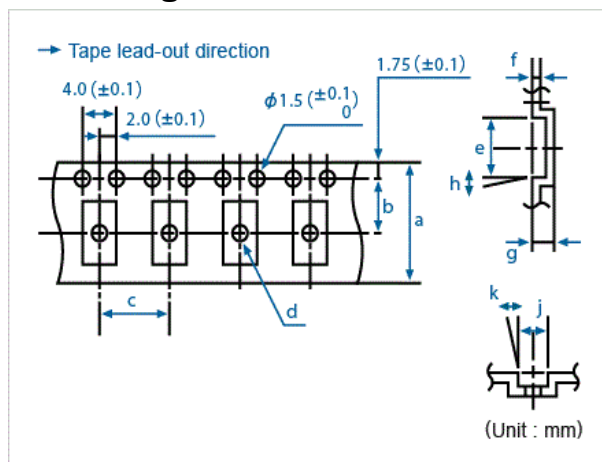

Conforming to JIS C 0806 TB1208NEIAJ and RC-1009B TE1208N

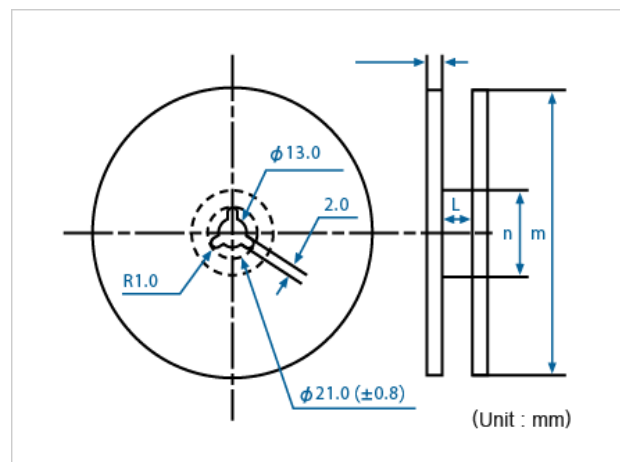

Conforming to JIS C 0806 R12R and EIAJ RC-1009B R15

Q'ty/reel	a	b	c	d (φ)	e	f	g	h	j	k	l	m (φ)	n (φ)
1,000	16.0	7.5	8.0	1.5	7.4	0.3	1.9	5°	5.4	5°	16.0	180	62

Product specifications are subject to change without notice.

Rev.2

X-ON Electronics

Largest Supplier of Electrical and Electronic Components

Click to view similar products for [Standard Clock Oscillators](#) category:

Click to view products by [Citizen](#) manufacturer:

Other Similar products are found below :

[EP1400SJTSC-125.000M](#) [601137](#) [601252](#) [CSX750FBC-24.000M-UT](#) [CSX750FBC-33.333M-UT](#) [CSX750FCC-3.6864M-UT](#) [F335-12](#) [F335-25](#) [F535L-50](#) [DSC506-03FM2](#) [ASA-20.000MHZ-L-T](#) [ASA-25.000MHZ-L-T](#) [ASA-27.000MHZ-L-T](#) [ASV-20.000MHZ-LR-T](#) [ECS-2018-160-BN-TR](#) [EL13C7-H2F-125.00M](#) [MXO45HS-2C-66.6666MHZ](#) [NBXDBB017LN1TAG](#) [NBXHBA019LN1TAG](#) [SiT1602BI-22-33E-50.000000E](#) [SIT8003AC-11-33S-2.04800X](#) [SiT8256AC-23-33E-156.250000X](#) [SIT8918AA-11-33S-50.000000G](#) [SM4420TEV-40.0M-T1K](#) [SMA4306-TL-H](#) [F335-24](#) [F335-40](#) [F335-50](#) [F535L-10](#) [F535L-12](#) [F535L-16](#) [F535L-24](#) [F535L-27](#) [F535L-48](#) [CSX750FBC-20.000M-UT](#) [CSX-750FBC33333000T](#) [CSX750FBC-4.000M-UT](#) [CSX750FBC-7.3728M-UT](#) [CSX750FBC-8.000M-UT](#) [CSX-750FCC14745600T](#) [CSX750FCC-16.000M-UT](#) [CSX-750FCC40000000T](#) [CSX750FCC-4.000M-UT](#) [ASA-22.000MHZ-L-T](#) [ASA2-26.000MHZ-L-T](#) [ASA-40.000MHZ-L-T](#) [ASA-48.000MHZ-L-T](#) [ASA-60.000MHZ-L-T](#) [ASF1-3.686MHZ-N-K-S](#) [XLH735025.000JU4I8](#)