

# 芯位

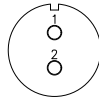

2P

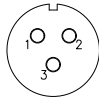

3P

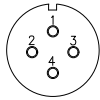

4P

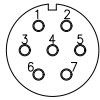

7P

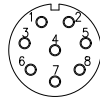

8P

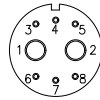

8P B

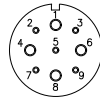

9P

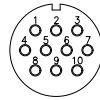

10P

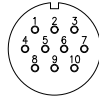

10P B

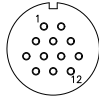

12P

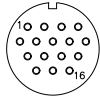

16P

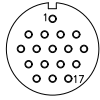

17P

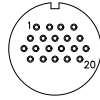

20P

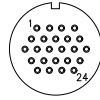

24P

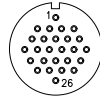

26P

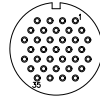

35P

芯数	2P	3P	4P	7P	8P	8P B	9P	10P	10P B	12P	16P	17P	20P	24P	26P	35P
工作电压 (V)	500	500	500	500	500	500/400	500	500	500	500	500	500	400	400	400	400
额定电流 (A)	50	50	25	25	25	60/5	25/5	25	10	10	10	10	5	5	5	5
耐压 (V)	1500	1500	1500	1500	1500	1500	1500	1500	1500	1500	1500	1500	1200	1200	1200	1200
接触电阻 (mΩ)	0.5	0.5	1	1	1	5/0.5	1/5	1	2.5	2.5	2.5	2.5	5	5	5	5

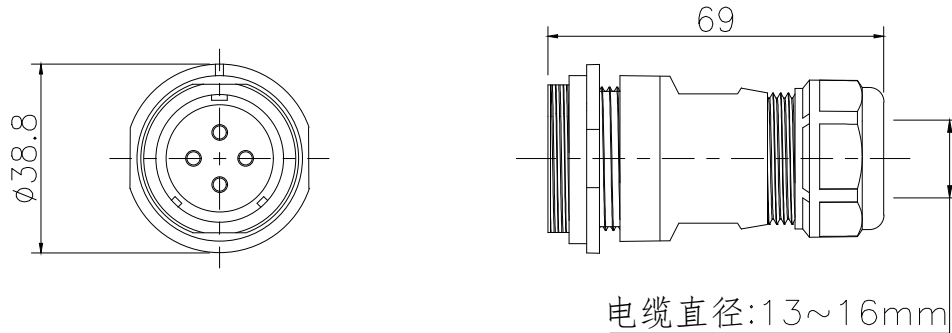

## 材料和技术参数

接插方式:	螺纹锁紧
外壳材料:	热塑性塑料PC, PA66 防火等级: V-0
绝缘体:	热塑性塑料PPS, 耐高温260° C
接触件材料:	铜, 镀金
接线方式:	焊接, 螺丝压接
电缆直径:	13~16 mm
防护等级:	IP68
接插次数:	500
温度范围:	-40°C ~ +85°C
绝缘电阻:	2000 MΩ

GENERAL TOLERANCE (UNLESS SPECIFIED)	DWN	DATE	TITLE
	LL	2022.10.10	
≤10 ±0.1	CHK	DATE	JH2811S 塑料组装式孔型插头
<10~≤20 ±0.2	APVD	DATE	
<20~≤50 ±0.5	UNIT	REV	PART NO
Angle ±1'	MM	A	
	SIZE	SHEET	DRAWING NO
THIRD ANGLE	A4	1 OF 1	

## X-ON Electronics

Largest Supplier of Electrical and Electronic Components

*Click to view similar products for [Standard Circular Connector](#) category:*

*Click to view products by [Cixi Kefa](#) manufacturer:*

Other Similar products are found below :

[600273N007](#) [6134-336-13149](#) [6134-337-11149](#) [6134-337-2390](#) [6134-341-17149](#) [67-02E12-60PX](#) [680-SMG](#) [CXS3102A181S](#)  
[D38999/20FC8SA L/C](#) [75-190216-08S](#) [75-190611-03S](#) [75-474014-05S](#) [75-474618-04S](#) [75-474620-07P](#) [799539-000](#) [805-005-07NF11-19PC](#)  
[805-005-07NF15-7PA](#) [FMP.2M.310.XLCT](#) [836783-1](#) [862256-1](#) [866857-1](#) [867865-1](#) [PT08P-14-19S](#) [PT08P-14-5S](#) [QCM019PC2DC012B](#)  
[121583-0217](#) [121667-0020](#) [RD10A16-19-P6CS051/1](#) [RD16A14-12-S6CS051/2](#) [1301240268](#) [1301240275](#) [1301860906](#) [DCU-08BFEA-](#)  
[LL7001](#) [RM15WTP-CP\(5\)\(71\)](#) [14482](#) [16283-18](#) [1877910-1](#) [206039-3](#) [206323-1](#) [207002-2](#) [207682-1](#) [CA06COME14SA7P](#) [211777-1](#) [JL04-](#)  
[1012CK\(05\)-R](#) [JL04V-2A28-11PE-R](#) [JL04V-2E10SL-3PE-B-R](#) [JL04V-2E20-15PE-B-R](#) [JL04V-2E20-4PE-B-R](#) [JL04V-2E24-10PE\(G\)-B-R](#)  
[JL04V-6A24-11SE-EB-R](#)