

linear dimension(Tolerances Standard GB/T 14486-2008)

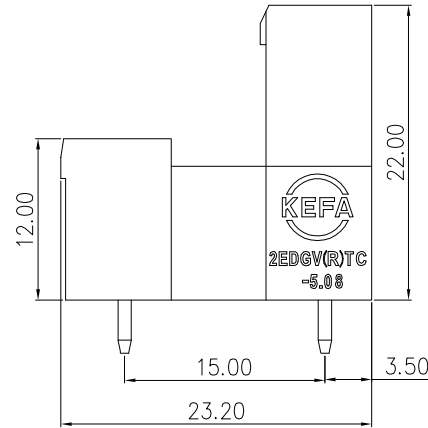

variable range	to	over 6 to 10	over 10 to 30	over 30 to 60	over 60 to 100	over 100 to 160	over 160 to 10	over 10 to 100	over 100 to 10	
	6	10	30	60	100	160	10	100	100	
tolerance	±0.20	±0.30	±0.50	±0.70	±1.00	±1.30	±1.60	0.10	0.30	0.60

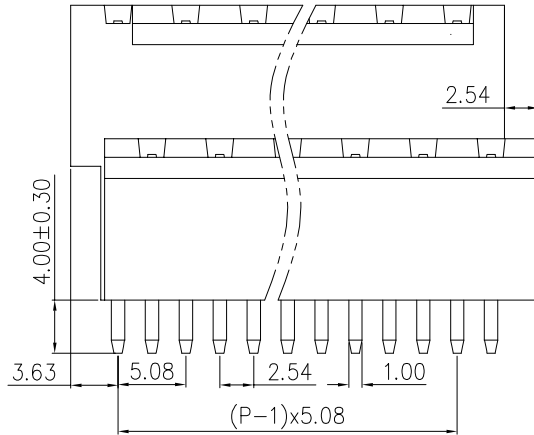
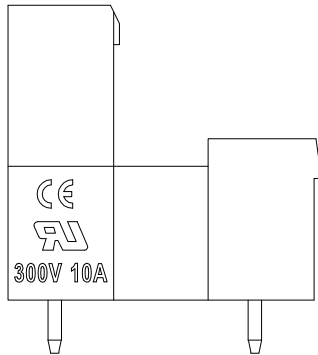
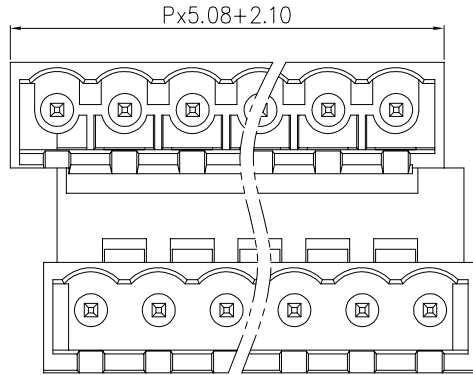
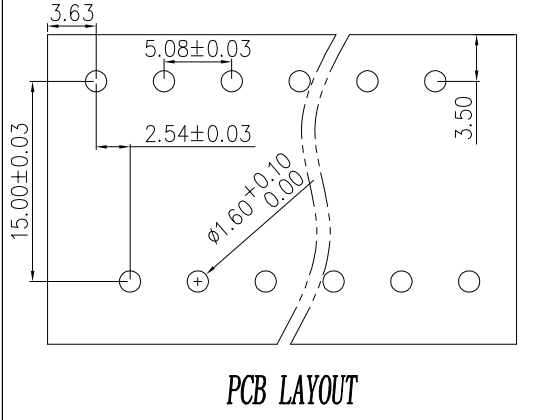

REVISION RECORD

REV.	DESCRIPTION	ECN No.	APPROVED	DATE
A	新发行		CLF	21.03.13

UL/CUL 技术参数		UL/CUL Technical Data		
等级	Use Group	B	C	D
额定电压	Rated Voltage [V]	300	-	300
额定电流	Rated Current [A]	10	-	10
接线范围	Wire Range	-		
单/多芯线	Solid/Stranded [AWG]	-		
耐电压	Withstanding Voltage	1600V/1Min		
IEC 技术参数		IEC Technical Data		
过电压类别	Overvoltage Category	III	III	II
污染等级	Contamination Class	3	2	2
额定电压	Rated Voltage [V]	-	320	630
额定电流	Rated Current [A]	-	15	15
额定冲击电压	Impulse withstand voltagea [KV]	-	4.0	4.0
导线截面积	Conductor cross section	-		
硬质/柔性导线	Solid/flexible [mm ²]	-		
材料		Material		
绝缘材料	Insulation Material	PA66		
阻燃等级	Imflamability	UL94V-0		
导体材料	Contactive Material	铜合金 Copper alloy		
导体表面镀层	Contactive Coating	镀锡 Tin Plated		
一般参数		Other Data		
间距	Pitch [mm]	5.08		
极数	Poles [P]	2-24		
剥线长度	Stripping Length [mm]	-		
螺丝	Screw/扭矩 Torque(Max) [N.m]	-		
工作温度	Operating temperatur [°C]	-40~+105		
引针尺寸	Pin Dimensions [mm]	4.0		
PCB板孔径	PCB Hole Diameter [mm]	1.6		

DES.	LQQ	DATE	21.03.13	单位 / UNITS	mm	尺寸 / SIZE	A4	比例 / SCALE	1:1	第三视角 / THIRD ANGLE PROJECTION	版本 / REV	A
CHK.	SY	DATE	21.03.13	慈溪市科发电子有限公司 CIXI KEFA ELECTRONIC CO., LTD				名称 / TITLE	KF2EDGVTC-5.08			
APP.	CLF	DATE	21.03.13									

X-ON Electronics

Largest Supplier of Electrical and Electronic Components

Click to view similar products for [Pluggable Terminal Blocks](#) category:

Click to view products by [Cixi Kefa](#) manufacturer:

Other Similar products are found below :

[57.510.0053](#) [721-104/026-047](#) [721-204/026-045](#) [MC 1.5/ 6-ST-3.5 GY AU](#) [ET02015000J0G](#) [860505](#) [860516](#) [860810](#) [GBPACX-12](#)
[93.731.4953.0](#) [PVP03-3,50](#) [PVS02-5,00](#) [1-1986160-3](#) [1377680000](#) [1531000000](#) [1546228-5](#) [ELFP03110](#) [ELFP10210](#) [ELFT07250](#)
[ELVD12100](#) [ELVF09400](#) [ELXH071G0E](#) [1725220000](#) [1760336](#) [1855000000](#) [19346](#) [1946309](#) [1973592](#) [19892](#) [25.320.4053.1](#) [25.320.4553.9](#)
[25.320.4753.1](#) [25.320.5453.1](#) [25.340.0353.1](#) [25.340.1053.1](#) [25.345.3553.0M001](#) [25.640.3553.1](#) [SH02-5,08](#) [SH06-3,81](#) [SH08-5,08](#) [SH08-](#)
[5,08-K](#) [SH12-5,08](#) [SHS04-5,00](#) [30.303](#) [30.305](#) [30.306](#) [PHP09-5,08](#) [25.193.0453.0](#) [25.320.4653.1](#) [25.332.2453.1](#)