

linear dimension(Tolerances Standard GB/T 14486-2008)								—	∇	\perp
variable range	to	over 6	over 10	over 30	over 60	over 100	over 160	to	over 10	over 100
	6	to 10	to 30	to 60	to 100	to 160	10		to 100	to
tolerance	± 0.20	± 0.30	± 0.50	± 0.70	± 1.00	± 1.30	± 1.60	0.10	0.30	0.60

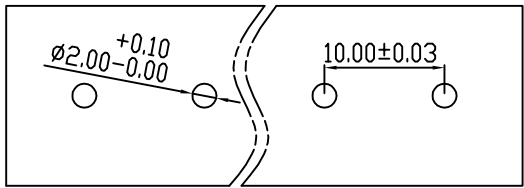

PCB LAYOUT

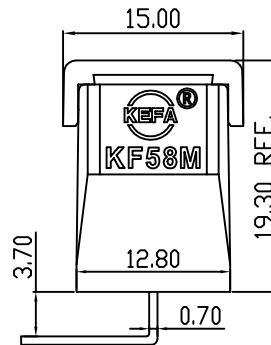
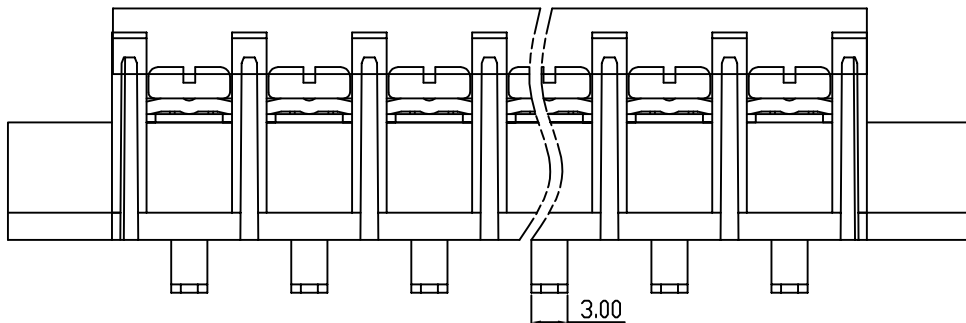
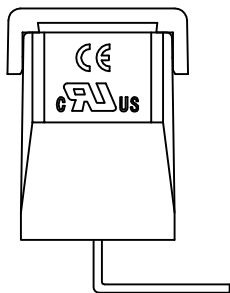
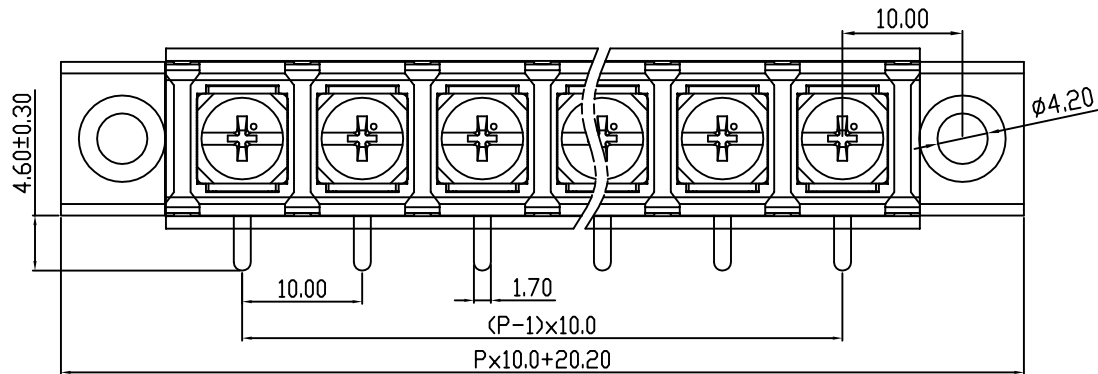

REVISION RECORD				
REV.	DESCRIPTION	ECN No.	APPROVED	DATE
A	新发行		CLF	21.09.28

UL/CUL 技术参数		UL/CUL Technical Data		
等级	Use Group	B	C	D
额定电压	Rated Voltage [V]	300	-	-
额定电流	Rated Current [A]	20	-	-
接线范围	Wire Range	22-12		
单/多芯线	Solid/Stranded [AWG]			
IEC 技术参数		IEC Technical Data		
额定电压	Rated Voltage [V]	750		
额定电流	Rated Current [A]	32		
耐电压	Withstanding Voltage	3000V/1Min		
导线截面积	Conductor cross section	4.0		
硬质/柔性导线	Solid/flexible [mm ²]			
材料		Material		
绝缘材料	Insulation Material	PA66		
阻燃等级	Imflammability	UL94V-0		
导体材料	Contacting Material	铜合金 Copper alloy		
导体表面镀层	Contactive Coating	镀锡 Tin plated		
一般参数		Other Data		
间距	Pitch [mm]	10.0		
极数	Poles [P]	02-24		
剥线长度	Stripping Length [mm]	-		
螺丝	Screw/扭矩 Torque(Max) [N.m]	M4/1.0		
工作温度	Operating temperatur [°C]	-40~+105		
引针尺寸	Pin Dimensions [mm]	4.6		
PCB板孔径	PCB Hole Diameter [mm]	2.0		

DES.	LQQ	DATE	21.09.28	单位/UNITS	mm	尺寸/SIZE	A4	比例/SCALE	1:1	第三视角/THIRD ANGLE PROJECTION	版本/REV	A
CHK.	BY	DATE	21.09.28	慈溪市科发电子有限公司 CIXI KEFA ELECTRONIC CO., LTD		名称/TITLE		KF58RM-10.0				
APP.	CLF	DATE	21.09.28									

X-ON Electronics

Largest Supplier of Electrical and Electronic Components

Click to view similar products for [Barrier Terminal Blocks](#) category:

Click to view products by [Cixi Kefa](#) manufacturer:

Other Similar products are found below :

[CR151D20104](#) [670A-RZ-15-KT20](#) [6C1N03](#) [6PCR-02](#) [6PCR-02-008](#) [6PCR-05-008](#) [6PCR-08-008](#) [6PCR-09-008](#) [6PCR-13-006](#) [6PCR-15-006](#) [6PCV-06-008](#) [6PCV-06-716](#) [6PCV-09-001](#) [6PCV-15-008](#) [6PCV-17-1206](#) [6PCV-20-323](#) [6STR-06-006](#) [6STR-08-006](#) [6STR-12-008](#) [6STR-13-006](#) [6STR-14-008](#) [6STR-16-008](#) [6STR-17-008](#) [6STR-21-008](#) [6STR-25-008](#) [6STR-27-008](#) [6STV-03-008](#) [6STV-09-006](#) [6STV-10-006](#) [6WWV-11-008](#) [6WWV-12-008](#) [6WWV-16-008](#) [71502-50](#) [71507-47-50](#) [72504-C-50](#) [72506-C](#) [72507-C-50](#) [72508-56](#) [73203](#) [75505-C-50](#) [812-GP-3/4ST-09](#) [812-GPZ-03PSB](#) [8-1437402-5](#) [8-1437402-7](#) [8PCR-06-006](#) [8PCR-11-006](#) [8PCV-04-001](#) [8PCV-05-008](#) [8PCV-09-006](#) [8PCV-15-006](#)