

【*】[®] 慈溪市东威电子有限公司
CIXI CITY DONGWEI ELECTRONICS CO., LTD

SPECIFICATION



客 户
 CUSTOMER: _____

品 名
 TITLE: 拨码开关 (DIP SWITCH)

型 号
 PART ON.: HAM-03LWA-R

客 户 型 号
 CUSTOMER PART NO.: _____

日 期
 DATE: _____

| | | | |
|---|-------------------|--|---|
| 制 样 DESIGNED BY | 审 核 CHECKED BY | 批 准 APPROVED BY | 送样印 SENDING PRINT |
|  | Alice |  |  |
| 客 户 确 认 CUSTOMER APPROVAL | | 承 认 印 APPD PRINT | |
| | | | |

地址: 浙江省慈溪市逍林青春路245号
 Add: No#245 qingchun road, xiaolin, cixi, zhejiang
 电话(Tel): +86-574-63501386 63501528
 传真(Fax): +86-574-63500156
 邮编(P. C.): 315321
[Http://www.tonver.com](http://www.tonver.com)
 E-mail: tonver@tonver.com



制品规格 SPECIFICATIONS OF PRODUCTS

| | | | | | |
|----------------------|---------------------------------------|--|-----------|--|-----------------|
| 文件编号 DOCUMENT NO. | DW-SP-011-03 | 发行日期 ISSUED DATE | 2012-4-17 | 版本: 2.0 VERSION | 页次: 3/4 PAGE |
| 项目 ITME | | | | 性能 PERFORMANCE | |
| 5.3 | 使用温度 OPERATING TEMPERATURE: |  | | -20°C ~ +70°C | |
| 5.4 | 储存温度 STORAGE TEMPERATURE: | | | -40°C ~ +85°C | |
| 5.5 | 可焊性 SOLDERABILITY: | | | After flux 230±5°C for 5±0.5seconds, 95%coverage | |
| 5.6 | 耐焊接热 RESISTANCE TO SOLDERING HEAT: | | | 260±5°C for 5±1seconds | |

6. 焊接和清洗 SOLDERING AND CLEANING PROCESSES

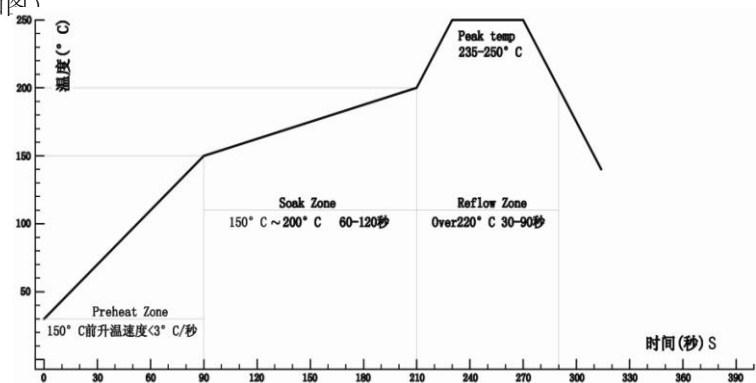
| | | |
|-----|---|---|
| 6.1 | 在所有操作过程中, 请确保开关在OFF位置 | Keep all switch contacts in their "OFF" position for all operations |
| 6.2 | 波焊: 推荐焊接焊锡温度为500° F(260°C), 最多5秒 | WAVE SOLDERING: Recommended solder temperature at 500° F(260°C) max.5 seconds |
| 6.3 | 手焊: 使用30W烙铁控制温度在350°C, 焊接时间大约5秒钟 | HAND SOLDERING: Use a soldering iron of 30 Watts controlled at 350°C approximately 5 seconds. While |
| 6.4 | 回流焊: (SMT型) 回流炉最高温度为250°C, 温度为250°C时, 最长不超过10秒 (如图) | Reflow Soldering Profile: (reference)  |

7. 产品包装 PACKING

| | | | | | | |
|-----|-----------------------------|---|-------------------|------------------|------------------|---|
| 7.1 | 所有拨码产品皆以IC管形式包装 HA系列包装资料 | All Code Switches are shipped in standard IC tube Packing of HA | | | | |
| | | 系列 SERIES | 开关位数 NO.of POS | 每管数量 PER TUBE | 每小箱数量 PER BOX | 外箱包装 PERCTN 6 BOXES 55.5×30.5×40CM |
| | HA | 1 | 130PCS | 13000PCS | | |
| | HA | 2 | 77PCS | 7700PCS | | |
| | HA | 3 | 55PCS | 5500PCS | | |
| | HA | 4 | 42PCS | 4200PCS | | |
| | HA | 5 | 34PCS | 3400PCS | | |
| | HA | 6 | 29PCS | 2900PCS | | |
| | HA | 7 | 25PCS | 2500PCS | | |
| | HA | 8 | 22PCS | 2200PCS | | |
| | HA | 9 | 20PCS | 2000PCS | | |
| | HA | 10 | 18PCS | 1800PCS | | |
| HA | 12 | 15PCS | 1500PCS | | | |



制品规格 SPECIFICATIONS OF PRODUCTS

| | | | | | |
|----------------------|--------------|---------------------|-----------|--------------------|-----------------|
| 文件编号 DOCUMENT NO. | DW-SP-011-03 | 发行日期 ISSUED DATE | 2012-4-17 | 版本: 2.0 VERSION | 页次: 4/4 PAGE |
|----------------------|--------------|---------------------|-----------|--------------------|-----------------|

8. 产品外形及装配图纸 SHAPE AND ASSEMBLY SIZE

DIMENSION A (General tolerance: ± 0.3)

| POSITIONS | 1 | 2 | 3 | 4 | 5 | 6 | 7 | 8 | 9 | 10 | 12 |
|-----------|------|------|------|-------|-------|-------|-------|-------|-------|-------|-------|
| A | 3.64 | 6.18 | 8.72 | 11.26 | 13.80 | 16.34 | 18.88 | 21.42 | 23.96 | 26.50 | 31.58 |

HAM DIMENSIONS Unit:mm

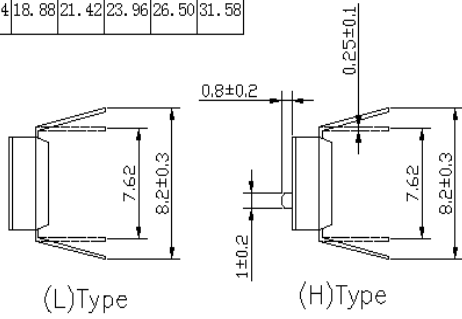
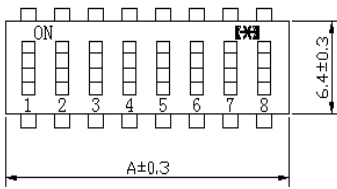

| ITEM | DES | MATERIALS | TREATMENT |
|------|----------|----------------------|--------------|
| 1 | COVER | ENGINEERING PLASTICS | BLACK |
| 2 | BASE | ENGINEERING PLASTICS | BLACK |
| 3 | KEY | ENGINEERING PLASTICS | WHITE |
| 4 | TERMINAL | ALLOY COPPER | PLATING GOLD |

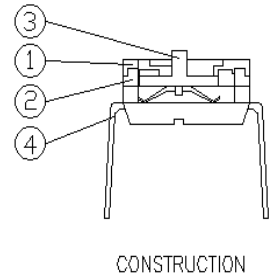
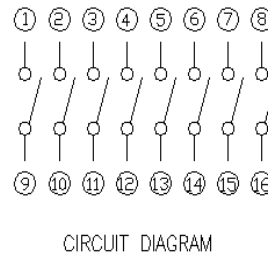
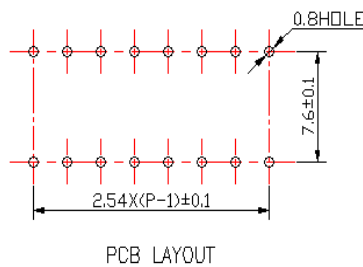
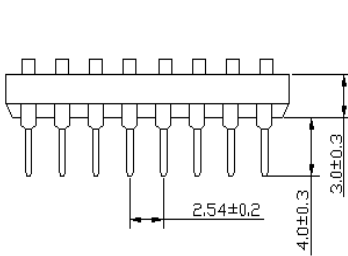

X-ON Electronics

Largest Supplier of Electrical and Electronic Components

Click to view similar products for [DIP Switches/SIP Switches](#) category:

Click to view products by [Cixi Tonver](#) manufacturer:

Other Similar products are found below :

[79B10T](#) [8136-475G4T](#) [G7G-1A2-CB-DC12](#) [H7CZL8AC100240](#) [DRR60016](#) [DRS4016](#) [1825008-1](#) [1825444-1](#) [200183](#) [206002](#) [219-6LPSTRF](#) [25.350.0653.0](#) [SBS 5004 TG](#) [SDA10H1BDA](#) [97R06ST](#) [A2C-2A5](#) [1825444-7](#) [ADE08SA04](#) [ADE12S04](#) [192960010](#) [206005RAS](#) [206007](#) [2-1825058-8](#) [25.330.0653.1](#) [25.352.0353.0](#) [CXDRIVEV2X](#) [IKN0600000](#) [IKN0800000](#) [LA2-002-DC24](#) [DRD10CRAE04](#) [DSR02T](#) [DSS 208 N](#) [E2FMX2D1M1TGJ03M](#) [NDI10H](#) [219-9MSTP](#) [EPM02FV](#) [206010RAST](#) [NDS08V](#) [76SB05](#) [TD06H0SK1](#) [Z7.255.9027.0](#) [1-1825058-3](#) [1825428-4](#) [219-10LPSTF](#) [E3ZG6111D03M](#) [G4D212PUSTV2DC5](#) [EPG301BT06](#) [219-7LPSTRF](#) [1-1825058-6](#) [E3TSL23M5J03M](#)