

【*】[®] 慈溪市东威电子有限公司
CIXI CITY DONGWEI ELECTRONICS CO., LTD

SPECIFICATION



客 户
CUSTOMER: _____

品 名
TITLE: 拨码开关 (DIP SWITCH) _____

型 号
PART ON.: VPG/S-02H-R _____

客 户 型 号
CUSTOMER PART NO.: _____

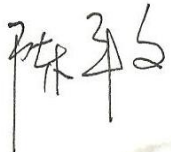
日 期
DATE: _____

制 样 DESIGNED BY	审 核 CHECKED BY	批 准 APPROVED BY	送样印 SENDING PRINT
	Alice		
客 户 确 认 CUSTOMER APPROVAL		承 认 印 APPD PRINT	

地址: 浙江省慈溪市逍林青春路245号
 Add: No#245 qingchun road, xiaolin, cixi, zhejiang
 电话(Tel): +86-574-63501386 63501528
 传真(Fax): +86-574-63500156
 邮编(P. C.): 315321
[Http://www.tonver.com](http://www.tonver.com)
 E-mail: tonver@tonver.com



制品规格 SPECIFICATIONS OF PRODUCTS

文件编号 DOCUMENT NO.	DW-SP-014-02	发行日期 ISSUED DATE	2012-4-17	版本: 2.0 VERSION	页次: 2/3 PAGE
----------------------	--------------	---------------------	-----------	--------------------	-----------------

1. 材料 MATERIALS

	上盖: 工程塑料, 红色、蓝色、黑色	COVER: Engineering Plastics, Red、Blue、Black
	底座: 工程塑料, 黑色	BASE: Engineering Plastics, Black
	按键: 工程塑料, 白色	KEY: Engineering Plastics, White
	端子: 铜合金, 镀金或者镀银	TERMINAL: Alloy Copper, Plating Gold or Ag

2. 产品命名 PRODUCT NAMING

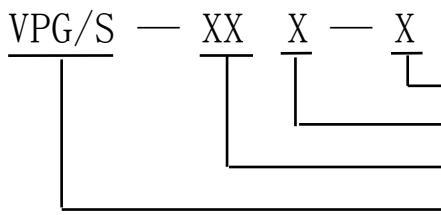

R为环保型 0为普通型 R:rohs 0:common
 外壳颜色:H:为红色 L:为蓝色 B:为黑色 Color: H:red L:blue B:black
 产品位数 Position of product
 V系列 V series
 XG/S=DG/S:按键方式为平拨 XG/S=DG/S:key is flat
 XG/S=PG/S:按键方式为侧拨 XG/S=PG/S:key is side

3. 产品位数代号 NUMBER OF POSITIONS

02	03	04	05	06	07	08	09	10	12
二位 two	三位 three	四位 four	五位 five	六位 six	七位 seven	八位 eight	九位 nine	十位 ten	十二位 twelve

4. 电气性能 ELECTRICAL CHARACTERISTICS

项目 ITME		性能 PERFORMANCE
4.1	接触电阻(初始值) CONTACT RESISTANCE (INITIAL) :	≤50mΩ
4.2	接触电阻(测试后) (AFTER LIFE TEST) :	≤100mΩ
4.3	开关容量(开关常切换) CONTACT RATING (CONTACT RATING) :	25mA 24VDC
4.4	开关容量(开关不常切换) CONTACT RATING (NON-CONTACT RATING) :	100mA
4.5	绝缘电阻 INSULATION RESISTANCE:	≥100MΩ .Min.at 500VDC
4.6	耐压强度 DIELECTRIC STRENGTH:	500VAC Min. for 60 seconds. 1mA
4.7	极际电容 CAPACITANCE BETWEEN ADJACENT SWITCHES:	≤5PF



5. 机械特性 MECHANICAL

项目 ITME		性能 PERFORMANCE
5.1	操作力 OPERATION FORCE:	≤8N
5.2	机械寿命 MECHANICAL LIFE:	2000 operations
5.3	使用温度 OPERATING TEMPERATURE:	-20℃ ~ +70℃
5.4	储存温度 STORAGE TEMPERATURE:	-40℃ ~ +85℃
5.5	可焊性 SOLDERABILITY:	After flux 230±5℃for 5 ±0.5seconds, 95%coverage



制品规格 SPECIFICATIONS OF PRODUCTS

文件编号 DOCUMENT NO.	DW-SP-014-02	发行日期 ISSUED DATE	2012-4-17	版本: 2.0 VERSION	页次: 3/3 PAGE
项目 ITME				性能 PERFORMANCE	
5.6	耐焊接热 RESISTANCE TO SOLDERING HEAT:			260±5°C for 5±1seconds	



6. 焊接和清洗 SOLDERING AND CLEANING PROCESSES

6.1	在所有操作过程中, 请确保开关在OFF位置	Keep all switch contacts in their "OFF" position for all operations
6.2	波焊: 推荐焊接焊锡温度为500° F(260°C), 最多5秒	WAVE SOLDERING: Recommended solder temperature at 500° F(260°C) max.5 seconds
6.3	手焊: 使用30W烙铁控制温度在350°C, 焊接时间大约5秒钟	HAND SOLDERING: Use a soldering iron of 30 Watts controlled at 350°C approximately 5 seconds. While

7. 产品包装 PACKING

7.1	所有拨码产品皆以IC管形式包装 VPG/S系列包装资料	All Code Switches are shipped in standard IC tube Packing of VPG/S

系列 SERIES	开关位数 NO. of POS	每管数量 PER TUBE	每小箱数量 PER BOX	外箱包装 PER CTN
VPG/S	2	72PCS	6480PCS	6 BOXES 55.5×30.5×40CM
VPG/S	3	52PCS	4680PCS	
VPG/S	4	40PCS	3600PCS	
VPG/S	5	33PCS	2970PCS	
VPG/S	6	28PCS	2520PCS	
VPG/S	7	24PCS	2160PCS	
VPG/S	8	21PCS	1890PCS	
VPG/S	9	19PCS	1710PCS	
VPG/S	10	17PCS	1530PCS	
VPG/S	12	14PCS	1260PCS	

8. 产品外形及装配图纸 SHAPE AND ASSEMBLY SIZE

DIMENSION A (General tolerance: ±0.3)

POSITIONS	2	3	4	5	6	7	8	9	10	12
A	6.62	9.16	11.7	14.24	16.78	19.32	21.86	24.4	26.94	32.02

ITEM	DES	MATERIALS	TREATMENT
1	COVER	ENGINEERING PLASTICS	RED, BLUE, BLACK
2	BASE	ENGINEERING PLASTICS	BLACK
3	KEY	ENGINEERING PLASTICS	WHITE
4	TERMINAL	ALLOY COPPER	PLATING GOLD

VPG DIMENSIONS Unit:mm

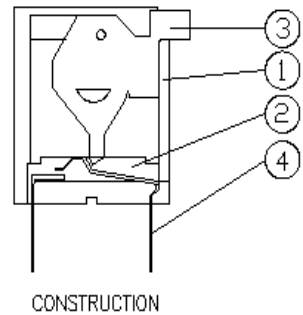
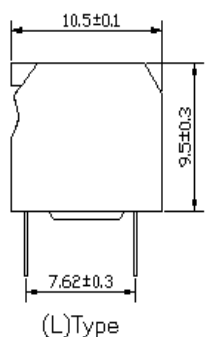
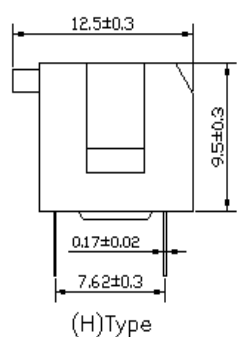
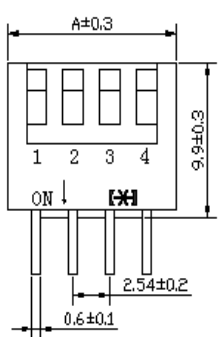
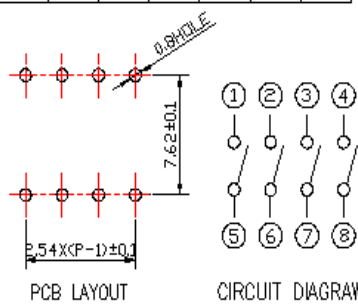
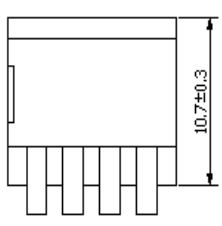

【*】[®] 慈溪市东威电子有限公司

CIXI CITY DONGWEI ELECTRONICS CO., LTD

SPECIFICATION

客 户

CUSTOMER: _____

品 名

TITLE:

拨码开关 (DIP SWITCH)

型 号

PART ON.:





VPG/S-03H-R

客 户 型 号

CUSTOMER PART NO.: _____

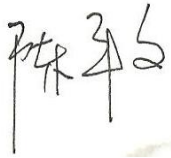
日 期

DATE: _____

制 样 DESIGNED BY	审 核 CHECKED BY	批 准 APPROVED BY	送样印 SENDING PRINT
			
客 户 确 认 CUSTOMER APPROVAL		承 认 印 APPD PRINT	

地址：浙江省慈溪市逍林青春路245号

Add: No#245 qingchun road, xiaolin, cixi, zhejiang

电话(Tel): +86-574-63501386 63501528

传真(Fax): +86-574-63500156

邮编(P. C.): 315321

[Http://www.tonver.com](http://www.tonver.com)

E-mail: tonver@tonver.com



制品规格 SPECIFICATIONS OF PRODUCTS

文件编号 DOCUMENT NO.	DW-SP-014-03	发行日期 ISSUED DATE	2012-4-17	版本: 2.0 VERSION	页次: 2/3 PAGE
----------------------	--------------	---------------------	-----------	--------------------	-----------------

1. 材料 MATERIALS

	上盖: 工程塑料, 红色、蓝色、黑色	COVER: Engineering Plastics, Red、Blue、Black
	底座: 工程塑料, 黑色	BASE: Engineering Plastics, Black
	按键: 工程塑料, 白色	KEY: Engineering Plastics, White
	端子: 铜合金, 镀金或者镀银	TERMINAL: Alloy Copper, Plating Gold or Ag

2. 产品命名 PRODUCT NAMING

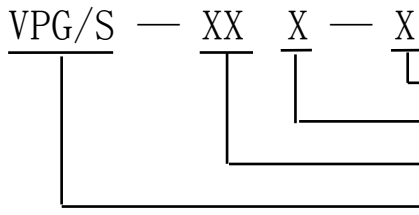

R为环保型 0为普通型 R:rohs 0:common
 外壳颜色:H:为红色 L:为蓝色 B:为黑色 Color: H:red L:blue B:black
 产品位数 Position of product
 V系列 V series
 XG/S=DG/S: 按键方式为平拨 XG/S=DG/S: key is flat
 XG/S=PG/S: 按键方式为侧拨 XG/S=PG/S: key is side

3. 产品位数代号 NUMBER OF POSITIONS

02	03	04	05	06	07	08	09	10	12
二位	三位	四位	五位	六位	七位	八位	九位	十位	十二位
two	three	four	five	six	seven	eight	nine	ten	twelve

4. 电气性能 ELECTRICAL CHARACTERISTICS

项目 ITME		性能 PERFORMANCE
4.1	接触电阻(初始值) CONTACT RESISTANCE (INITIAL) :	≤50mΩ
4.2	接触电阻(测试后) (AFTER LIFE TEST) :	≤100mΩ
4.3	开关容量(开关常切换) CONTACT RATING (CONTACT RATING) :	25mA 24VDC
4.4	开关容量(开关不常切换) CONTACT RATING (NON-CONTACT RATING) :	100mA
4.5	绝缘电阻 INSULATION RESISTANCE:	≥100MΩ .Min. at 500VDC
4.6	耐压强度 DIELECTRIC STRENGTH:	500VAC Min. for 60 seconds. 1mA
4.7	极际电容 CAPACITANCE BETWEEN ADJACENT SWITCHES:	≤5PF



5. 机械特性 MECHANICAL

项目 ITME		性能 PERFORMANCE
5.1	操作力 OPERATION FORCE:	≤8N
5.2	机械寿命 MECHANICAL LIFE:	2000 operations
5.3	使用温度 OPERATING TEMPERATURE:	-20℃ ~ +70℃
5.4	储存温度 STORAGE TEMPERATURE:	-40℃ ~ +85℃
5.5	可焊性 SOLDERABILITY:	After flux 230±5℃ for 5 ±0.5seconds, 95%coverage



制品规格 SPECIFICATIONS OF PRODUCTS

文件编号 DOCUMENT NO.	DW-SP-014-03	发行日期 ISSUED DATE	2012-4-17	版本: 2.0 VERSION	页次: 3/3 PAGE
项目 ITME				性能 PERFORMANCE	
5.6	耐焊接热 RESISTANCE TO SOLDERING HEAT:			260±5°C for 5±1seconds	



6. 焊接和清洗 SOLDERING AND CLEANING PROCESSES

6.1	在所有操作过程中, 请确保开关在OFF位置	Keep all switch contacts in their "OFF" position for all operations
6.2	波焊: 推荐焊接焊锡温度为500° F(260°C), 最多5秒	WAVE SOLDERING: Recommended solder temperature at 500° F(260°C) max.5 seconds
6.3	手焊: 使用30W烙铁控制温度在350°C, 焊接时间大约5秒钟	HAND SOLDERING: Use a soldering iron of 30 Watts controlled at 350°C approximately 5 seconds. While

7. 产品包装 PACKING

7.1	所有拨码产品皆以IC管形式包装 VPG/S系列包装资料	All Code Switches are shipped in standard IC tube Packing of VPG/S

系列 SERIES	开关位数 NO. of POS	每管数量 PER TUBE	每小箱数量 PER BOX	外箱包装 PER CTN
VPG/S	2	72PCS	6480PCS	6 BOXES 55.5×30.5×40CM
VPG/S	3	52PCS	4680PCS	
VPG/S	4	40PCS	3600PCS	
VPG/S	5	33PCS	2970PCS	
VPG/S	6	28PCS	2520PCS	
VPG/S	7	24PCS	2160PCS	
VPG/S	8	21PCS	1890PCS	
VPG/S	9	19PCS	1710PCS	
VPG/S	10	17PCS	1530PCS	
VPG/S	12	14PCS	1260PCS	

8. 产品外形及装配图纸 SHAPE AND ASSEMBLY SIZE

DIMENSION A (General tolerance: ±0.3)

POSITIONS	2	3	4	5	6	7	8	9	10	12
A	6.62	9.16	11.7	14.24	16.78	19.32	21.86	24.4	26.94	32.02

ITEM	DES	MATERIALS	TREATMENT
1	COVER	ENGINEERING PLASTICS	RED, BLUE, BLACK
2	BASE	ENGINEERING PLASTICS	BLACK
3	KEY	ENGINEERING PLASTICS	WHITE
4	TERMINAL	ALLOY COPPER	PLATING GOLD

VPG DIMENSIONS Unit:mm

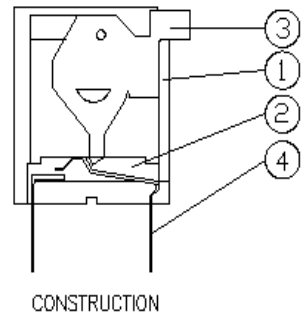
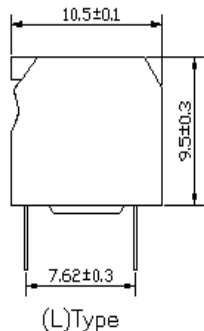
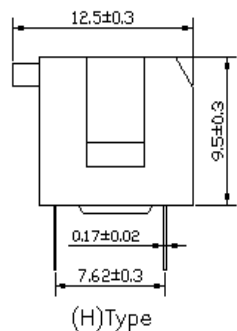
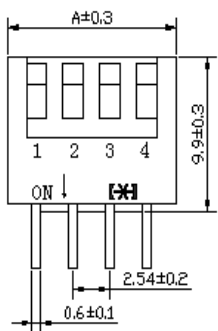
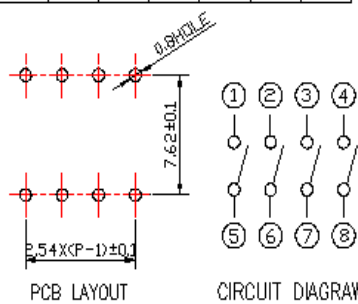
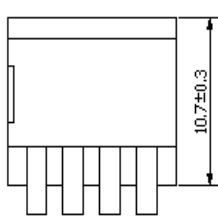

【*】[®] 慈溪市东威电子有限公司

CIXI CITY DONGWEI ELECTRONICS CO., LTD

SPECIFICATION

客 户

CUSTOMER: _____

品 名

TITLE:

拨码开关 (DIP SWITCH)

型 号

PART ON.:





VPG/S-04H-R

客 户 型 号

CUSTOMER PART NO. : _____

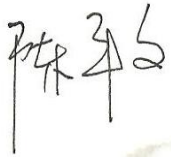
日 期

DATE: _____

制 样 DESIGNED BY	审 核 CHECKED BY	批 准 APPROVED BY	送样印 SENDING PRINT
			
客 户 确 认 CUSTOMER APPROVAL		承 认 印 APPD PRINT	

地址：浙江省慈溪市逍林青春路245号

Add: No#245 qingchun road, xiaolin, cixi, zhejiang

电话(Tel): +86-574-63501386 63501528

传真(Fax): +86-574-63500156

邮编(P. C.): 315321

[Http://www.tonver.com](http://www.tonver.com)

E-mail: tonver@tonver.com



制品规格 SPECIFICATIONS OF PRODUCTS

文件编号 DOCUMENT NO.	DW-SP-014-04	发行日期 ISSUED DATE	2012-4-17	版本: 2.0 VERSION	页次: 2/3 PAGE
----------------------	--------------	---------------------	-----------	--------------------	-----------------

1. 材料 MATERIALS

	上盖: 工程塑料, 红色、蓝色、黑色	COVER: Engineering Plastics, Red、Blue、Black
	底座: 工程塑料, 黑色	BASE: Engineering Plastics, Black
	拨键: 工程塑料, 白色	KEY: Engineering Plastics, White
	端子: 铜合金, 镀金或者镀银	TERMINAL: Alloy Copper, Plating Gold or Ag

2. 产品命名 PRODUCT NAMING

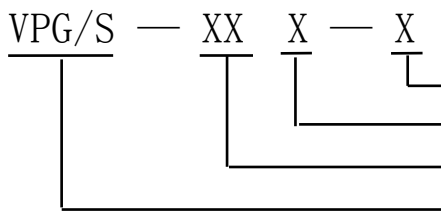

R为环保型 0为普通型 R:rohs 0:common
 外壳颜色:H:为红色 L:为蓝色 B:为黑色 Color: H:red L:blue B:black
 产品位数 Position of product
 V系列 V series
 XG/S=DG/S:拨键方式为平拨 XG/S=DG/S:key is flat
 XG/S=PG/S:拨键方式为侧拨 XG/S=PG/S:key is side

3. 产品位数代号 NUMBER OF POSITIONS

02	03	04	05	06	07	08	09	10	12
二位	三位	四位	五位	六位	七位	八位	九位	十位	十二位
two	three	four	five	six	seven	eight	nine	ten	twelve

4. 电气性能 ELECTRICAL CHARACTERISTICS

项目 ITME		性能 PERFORMANCE
4.1	接触电阻(初始值) CONTACT RESISTANCE (INITIAL) :	≤50mΩ
4.2	接触电阻(测试后) (AFTER LIFE TEST) :	≤100mΩ
4.3	开关容量(开关常切换) CONTACT RATING (CONTACT RATING) :	25mA 24VDC
4.4	开关容量(开关不常切换) CONTACT RATING (NON-CONTACT RATING) :	100mA
4.5	绝缘电阻 INSULATION RESISTANCE:	≥100MΩ .Min.at 500VDC
4.6	耐压强度 DIELECTRIC STRENGTH:	500VAC Min. for 60 seconds. 1mA
4.7	极际电容 CAPACITANCE BETWEEN ADJACENT SWITCHES:	≤5PF



5. 机械特性 MECHANICAL

项目 ITME		性能 PERFORMANCE
5.1	操作力 OPERATION FORCE:	≤8N
5.2	机械寿命 MECHANICAL LIFE:	2000 operations
5.3	使用温度 OPERATING TEMPERATURE:	-20℃ ~ +70℃
5.4	储存温度 STORAGE TEMPERATURE:	-40℃ ~ +85℃
5.5	可焊性 SOLDERABILITY:	After flux 230±5℃for 5 ±0.5seconds, 95%coverage



制品规格 SPECIFICATIONS OF PRODUCTS

文件编号 DOCUMENT NO.	DW-SP-014-04	发行日期 ISSUED DATE	2012-4-17	版本: 2.0 VERSION	页次: 3/3 PAGE
项目 ITME				性能 PERFORMANCE	
5.6	耐焊接热 RESISTANCE TO SOLDERING HEAT:			260±5°C for 5±1seconds	



6. 焊接和清洗 SOLDERING AND CLEANING PROCESSES

6.1	在所有操作过程中, 请确保开关在OFF位置	Keep all switch contacts in their "OFF" position for all operations
6.2	波焊: 推荐焊接焊锡温度为500° F(260°C), 最多5秒	WAVE SOLDERING: Recommended solder temperature at 500° F(260°C) max.5 seconds
6.3	手焊: 使用30W烙铁控制温度在350°C, 焊接时间大约5秒钟	HAND SOLDERING: Use a soldering iron of 30 Watts controlled at 350°C approximately 5 seconds. While

7. 产品包装 PACKING

7.1	所有拨码产品皆以IC管形式包装 VPG/S系列包装资料	All Code Switches are shipped in standard IC tube Packing of VPG/S

系列 SERIES	开关位数 NO. of POS	每管数量 PER TUBE	每小箱数量 PER BOX	外箱包装 PER CTN
VPG/S	2	72PCS	6480PCS	6 BOXES 55.5×30.5×40CM
VPG/S	3	52PCS	4680PCS	
VPG/S	4	40PCS	3600PCS	
VPG/S	5	33PCS	2970PCS	
VPG/S	6	28PCS	2520PCS	
VPG/S	7	24PCS	2160PCS	
VPG/S	8	21PCS	1890PCS	
VPG/S	9	19PCS	1710PCS	
VPG/S	10	17PCS	1530PCS	
VPG/S	12	14PCS	1260PCS	

8. 产品外形及装配图纸 SHAPE AND ASSEMBLY SIZE

DIMENSION A (General tolerance: ±0.3)

POSITIONS	2	3	4	5	6	7	8	9	10	12
A	6.62	9.16	11.7	14.24	16.78	19.32	21.86	24.4	26.94	32.02

ITEM	DES	MATERIALS	TREATMENT
1	COVER	ENGINEERING PLASTICS	RED, BLUE, BLACK
2	BASE	ENGINEERING PLASTICS	BLACK
3	KEY	ENGINEERING PLASTICS	WHITE
4	TERMINAL	ALLOY COPPER	PLATING GOLD

VPG DIMENSIONS Unit:mm

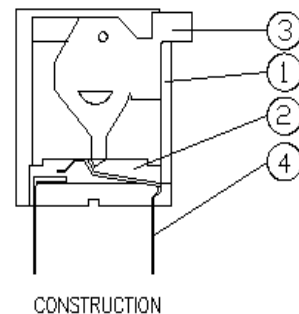
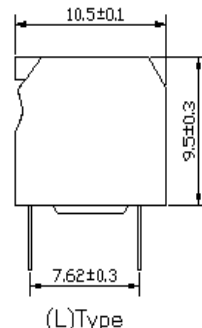
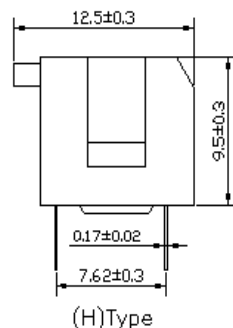
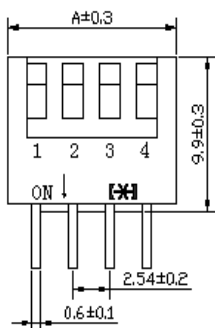
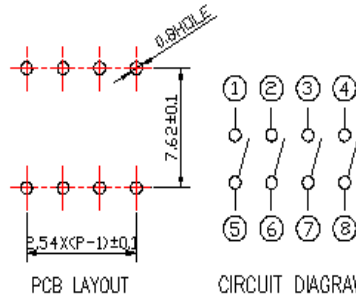
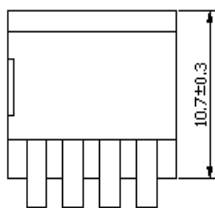

【*】[®] 慈溪市东威电子有限公司

CIXI CITY DONGWEI ELECTRONICS CO., LTD

SPECIFICATION

客 户

CUSTOMER: _____

品 名

TITLE: _____

拨码开关 (DIP SWITCH)

型 号

PART ON. : _____





VPG/S-05H-R

客 户 型 号

CUSTOMER PART NO. : _____

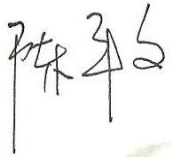
日 期

DATE: _____

制 样 DESIGNED BY	审 核 CHECKED BY	批 准 APPROVED BY	送样印 SENDING PRINT
			
客 户 确 认 CUSTOMER APPROVAL		承 认 印 APPD PRINT	

地址：浙江省慈溪市逍林青春路245号

Add: No#245 qingchun road, xiaolin, cixi, zhejiang

电话(Tel): +86-574-63501386 63501528

传真(Fax): +86-574-63500156

邮编(P. C.): 315321

[Http://www.tonver.com](http://www.tonver.com)

E-mail: tonver@tonver.com



制品规格 SPECIFICATIONS OF PRODUCTS

文件编号 DOCUMENT NO.	DW-SP-014-05	发行日期 ISSUED DATE	2012-4-17	版本: 2.0 VERSION	页次: 2/3 PAGE
----------------------	--------------	---------------------	-----------	--------------------	-----------------

1. 材料 MATERIALS

	上盖: 工程塑料, 红色、蓝色、黑色	COVER: Engineering Plastics, Red、Blue、Black
	底座: 工程塑料, 黑色	BASE: Engineering Plastics, Black
	按键: 工程塑料, 白色	KEY: Engineering Plastics, White
	端子: 铜合金, 镀金或者镀银	TERMINAL: Alloy Copper, Plating Gold or Ag

2. 产品命名 PRODUCT NAMING

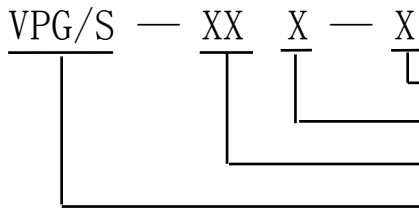

R为环保型 0为普通型 R:rohs 0:common
 外壳颜色:H:为红色 L:为蓝色 B:为黑色 Color: H:red L:blue B:black
 产品位数 Position of product
 V系列 V series
 XG/S=DG/S:按键方式为平拨 XG/S=DG/S:key is flat
 XG/S=PG/S:按键方式为侧拨 XG/S=PG/S:key is side

3. 产品位数代号 NUMBER OF POSITIONS

02	03	04	05	06	07	08	09	10	12
二位	三位	四位	五位	六位	七位	八位	九位	十位	十二位
two	three	four	five	six	seven	eight	nine	ten	twelve

4. 电气性能 ELECTRICAL CHARACTERISTICS

项目 ITME		性能 PERFORMANCE
4.1	接触电阻(初始值) CONTACT RESISTANCE (INITIAL) :	≤50mΩ
4.2	接触电阻(测试后) (AFTER LIFE TEST) :	≤100mΩ
4.3	开关容量(开关常切换) CONTACT RATING (CONTACT RATING) :	25mA 24VDC
4.4	开关容量(开关不常切换) CONTACT RATING (NON-CONTACT RATING) :	100mA
4.5	绝缘电阻 INSULATION RESISTANCE:	≥100MΩ .Min.at 500VDC
4.6	耐压强度 DIELECTRIC STRENGTH:	500VAC Min. for 60 seconds. 1mA
4.7	极际电容 CAPACITANCE BETWEEN ADJACENT SWITCHES:	≤5PF



5. 机械特性 MECHANICAL

项目 ITME		性能 PERFORMANCE
5.1	操作力 OPERATION FORCE:	≤8N
5.2	机械寿命 MECHANICAL LIFE:	2000 operations
5.3	使用温度 OPERATING TEMPERATURE:	-20℃ ~ +70℃
5.4	储存温度 STORAGE TEMPERATURE:	-40℃ ~ +85℃
5.5	可焊性 SOLDERABILITY:	After flux 230±5℃for 5 ±0.5seconds, 95%coverage



制品规格 SPECIFICATIONS OF PRODUCTS

文件编号 DOCUMENT NO.	DW-SP-014-05	发行日期 ISSUED DATE	2012-4-17	版本: 2.0 VERSION	页次: 3/3 PAGE
项目 ITME				性能 PERFORMANCE	
5.6	耐焊接热 RESISTANCE TO SOLDERING HEAT:			260±5°C for 5±1seconds	



6. 焊接和清洗 SOLDERING AND CLEANING PROCESSES

6.1	在所有操作过程中, 请确保开关在OFF位置	Keep all switch contacts in their "OFF" position for all operations
6.2	波焊: 推荐焊接焊锡温度为500° F(260°C), 最多5秒	WAVE SOLDERING: Recommended solder temperature at 500° F(260°C) max.5 seconds
6.3	手焊: 使用30W烙铁控制温度在350°C, 焊接时间大约5秒钟	HAND SOLDERING: Use a soldering iron of 30 Watts controlled at 350°C approximately 5 seconds. While

7. 产品包装 PACKING

7.1	所有拨码产品皆以IC管形式包装 VPG/S系列包装资料	All Code Switches are shipped in standard IC tube Packing of VPG/S

系列 SERIES	开关位数 NO. of POS	每管数量 PER TUBE	每小箱数量 PER BOX	外箱包装 PER CTN
VPG/S	2	72PCS	6480PCS	6 BOXES 55.5×30.5×40CM
VPG/S	3	52PCS	4680PCS	
VPG/S	4	40PCS	3600PCS	
VPG/S	5	33PCS	2970PCS	
VPG/S	6	28PCS	2520PCS	
VPG/S	7	24PCS	2160PCS	
VPG/S	8	21PCS	1890PCS	
VPG/S	9	19PCS	1710PCS	
VPG/S	10	17PCS	1530PCS	
VPG/S	12	14PCS	1260PCS	

8. 产品外形及装配图纸 SHAPE AND ASSEMBLY SIZE

DIMENSION A (General tolerance: ±0.3)

POSITIONS	2	3	4	5	6	7	8	9	10	12
A	6.62	9.16	11.7	14.24	16.78	19.32	21.86	24.4	26.94	32.02

ITEM	DES	MATERIALS	TREATMENT
1	COVER	ENGINEERING PLASTICS	RED, BLUE, BLACK
2	BASE	ENGINEERING PLASTICS	BLACK
3	KEY	ENGINEERING PLASTICS	WHITE
4	TERMINAL	ALLOY COPPER	PLATING GOLD

VPG DIMENSIONS Unit:mm

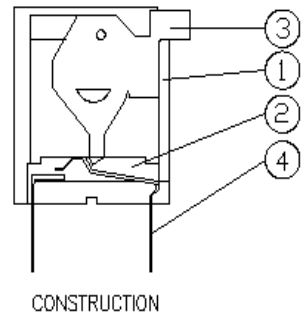
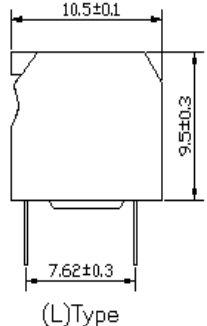
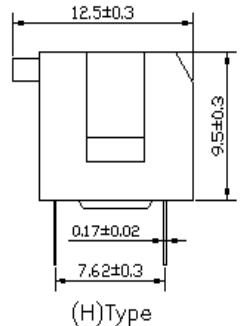
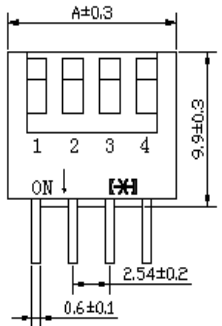
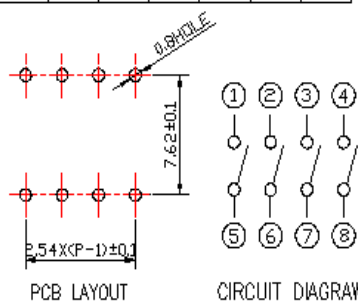
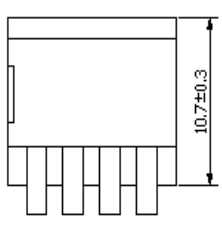

【*】[®] 慈溪市东威电子有限公司
CIXI CITY DONGWEI ELECTRONICS CO., LTD

SPECIFICATION



客 户
 CUSTOMER: _____

品 名
 TITLE: 拨码开关 (DIP SWITCH)

型 号
 PART ON.: VPG/S-06H-R

客 户 型 号
 CUSTOMER PART NO.: _____

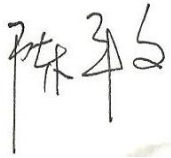
日 期
 DATE: _____

制 样 DESIGNED BY	审 核 CHECKED BY	批 准 APPROVED BY	送样印 SENDING PRINT
	Alice		
客 户 确 认 CUSTOMER APPROVAL		承 认 印 APPD PRINT	

地址: 浙江省慈溪市逍林青春路245号
 Add: No#245 qingchun road, xiaolin, cixi, zhejiang
 电话(Tel): +86-574-63501386 63501528
 传真(Fax): +86-574-63500156
 邮编(P. C.): 315321
[Http://www.tonver.com](http://www.tonver.com)
 E-mail: tonver@tonver.com



制品规格 SPECIFICATIONS OF PRODUCTS

文件编号 DOCUMENT NO.	DW-SP-014-06	发行日期 ISSUED DATE	2012-4-17	版本: 2.0 VERSION	页次: 2/3 PAGE
----------------------	--------------	---------------------	-----------	--------------------	-----------------

1. 材料 MATERIALS

	上盖: 工程塑料, 红色、蓝色、黑色	COVER: Engineering Plastics, Red、Blue、Black
	底座: 工程塑料, 黑色	BASE: Engineering Plastics, Black
	按键: 工程塑料, 白色	KEY: Engineering Plastics, White
	端子: 铜合金, 镀金或者镀银	TERMINAL: Alloy Copper, Plating Gold or Ag

2. 产品命名 PRODUCT NAMING

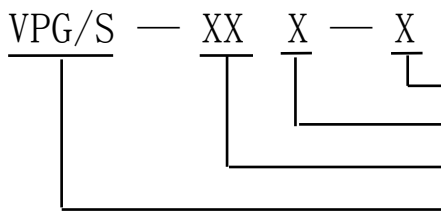

R为环保型 0为普通型 R:rohs 0:common
 外壳颜色:H:为红色 L:为蓝色 B:为黑色 Color: H:red L:blue B:black
 产品位数 Position of product
 V系列 V series
 XG/S=DG/S:按键方式为平拨 XG/S=DG/S:key is flat
 XG/S=PG/S:按键方式为侧拨 XG/S=PG/S:key is side

3. 产品位数代号 NUMBER OF POSITIONS

02	03	04	05	06	07	08	09	10	12
二位	三位	四位	五位	六位	七位	八位	九位	十位	十二位
two	three	four	five	six	seven	eight	nine	ten	twelve

4. 电气性能 ELECTRICAL CHARACTERISTICS

项目 ITME		性能 PERFORMANCE
4.1	接触电阻(初始值) CONTACT RESISTANCE (INITIAL) :	≤50mΩ
4.2	接触电阻(测试后) (AFTER LIFE TEST) :	≤100mΩ
4.3	开关容量(开关常切换) CONTACT RATING (CONTACT RATING) :	25mA 24VDC
4.4	开关容量(开关不常切换) CONTACT RATING (NON-CONTACT RATING) :	100mA
4.5	绝缘电阻 INSULATION RESISTANCE:	≥100MΩ .Min.at 500VDC
4.6	耐压强度 DIELECTRIC STRENGTH:	500VAC Min. for 60 seconds. 1mA
4.7	极际电容 CAPACITANCE BETWEEN ADJACENT SWITCHES:	≤5PF



5. 机械特性 MECHANICAL

项目 ITME		性能 PERFORMANCE
5.1	操作力 OPERATION FORCE:	≤8N
5.2	机械寿命 MECHANICAL LIFE:	2000 operations
5.3	使用温度 OPERATING TEMPERATURE:	-20℃ ~ +70℃
5.4	储存温度 STORAGE TEMPERATURE:	-40℃ ~ +85℃
5.5	可焊性 SOLDERABILITY:	After flux 230±5℃for 5 ±0.5seconds, 95%coverage



制品规格 SPECIFICATIONS OF PRODUCTS

文件编号 DOCUMENT NO.	DW-SP-014-06	发行日期 ISSUED DATE	2012-4-17	版本: 2.0 VERSION	页次: 3/3 PAGE
项目 ITME				性能 PERFORMANCE	
5.6	耐焊接热 RESISTANCE TO SOLDERING HEAT:			260±5°C for 5±1seconds	



6. 焊接和清洗 SOLDERING AND CLEANING PROCESSES

6.1	在所有操作过程中, 请确保开关在OFF位置	Keep all switch contacts in their "OFF" position for all operations
6.2	波焊: 推荐焊接焊锡温度为500° F(260°C), 最多5秒	WAVE SOLDERING: Recommended solder temperature at 500° F(260°C) max.5 seconds
6.3	手焊: 使用30W烙铁控制温度在350°C, 焊接时间大约5秒钟	HAND SOLDERING: Use a soldering iron of 30 Watts controlled at 350°C approximately 5 seconds. While

7. 产品包装 PACKING

7.1	所有拨码产品皆以IC管形式包装 VPG/S系列包装资料	All Code Switches are shipped in standard IC tube Packing of VPG/S

系列 SERIES	开关位数 NO. of POS	每管数量 PER TUBE	每小箱数量 PER BOX	外箱包装 PER CTN
VPG/S	2	72PCS	6480PCS	6 BOXES 55.5×30.5×40CM
VPG/S	3	52PCS	4680PCS	
VPG/S	4	40PCS	3600PCS	
VPG/S	5	33PCS	2970PCS	
VPG/S	6	28PCS	2520PCS	
VPG/S	7	24PCS	2160PCS	
VPG/S	8	21PCS	1890PCS	
VPG/S	9	19PCS	1710PCS	
VPG/S	10	17PCS	1530PCS	
VPG/S	12	14PCS	1260PCS	

8. 产品外形及装配图纸 SHAPE AND ASSEMBLY SIZE

DIMENSION A (General tolerance: ±0.3)

POSITIONS	2	3	4	5	6	7	8	9	10	12
A	6.62	9.16	11.7	14.24	16.78	19.32	21.86	24.4	26.94	32.02

ITEM	DES	MATERIALS	TREATMENT
1	COVER	ENGINEERING PLASTICS	RED, BLUE, BLACK
2	BASE	ENGINEERING PLASTICS	BLACK
3	KEY	ENGINEERING PLASTICS	WHITE
4	TERMINAL	ALLOY COPPER	PLATING GOLD

VPG DIMENSIONS Unit:mm

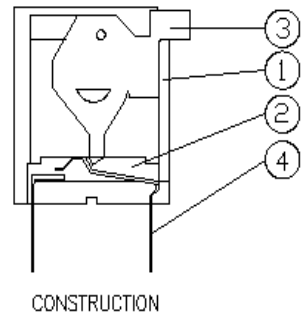
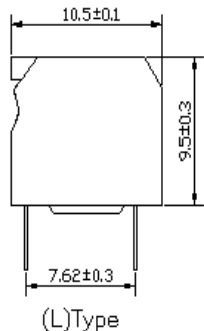
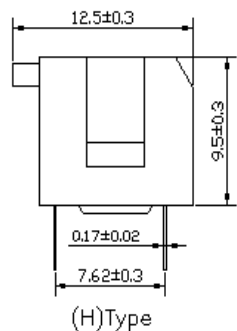
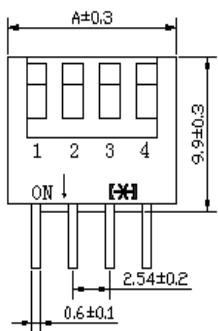
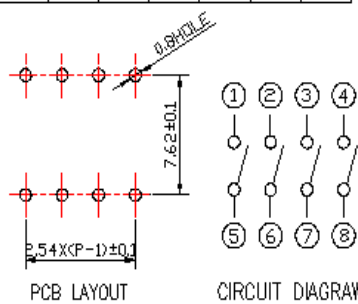
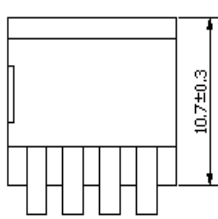

【*】[®] 慈溪市东威电子有限公司
CIXI CITY DONGWEI ELECTRONICS CO., LTD

SPECIFICATION



客 户
 CUSTOMER: _____

品 名
 TITLE: 拨码开关 (DIP SWITCH) _____

型 号
 PART ON.: VPG/S-07H-R _____

客 户 型 号
 CUSTOMER PART NO.: _____

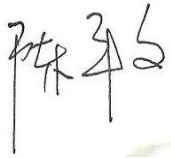
日 期
 DATE: _____

制 样 DESIGNED BY	审 核 CHECKED BY	批 准 APPROVED BY	送样印 SENDING PRINT
	Alice		
客 户 确 认 CUSTOMER APPROVAL		承 认 印 APPD PRINT	

地址: 浙江省慈溪市逍林青春路245号
 Add: No#245 qingchun road, xiaolin, cixi, zhejiang
 电话(Tel): +86-574-63501386 63501528
 传真(Fax): +86-574-63500156
 邮编(P. C.): 315321
[Http://www.tonver.com](http://www.tonver.com)
 E-mail: tonver@tonver.com



制品规格 SPECIFICATIONS OF PRODUCTS

文件编号 DOCUMENT NO.	DW-SP-014-07	发行日期 ISSUED DATE	2012-4-17	版本: 2.0 VERSION	页次: 2/3 PAGE
----------------------	--------------	---------------------	-----------	--------------------	-----------------

1. 材料 MATERIALS

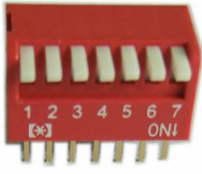
	上盖: 工程塑料, 红色、蓝色、黑色	COVER: Engineering Plastics, Red、Blue、Black
	底座: 工程塑料, 黑色	BASE: Engineering Plastics, Black
	按键: 工程塑料, 白色	KEY: Engineering Plastics, White
	端子: 铜合金, 镀金或者镀银	TERMINAL: Alloy Copper, Plating Gold or Ag

2. 产品命名 PRODUCT NAMING

VPG/S — XX X — X	R为环保型 0为普通型	R:rohs 0:common
	外壳颜色:H:为红色 L:为蓝色 B:为黑色	Color: H:red L:blue B:black
	产品位数	Position of product
	V系列	V series
	XG/S=DG/S:按键方式为平拨	XG/S=DG/S:key is flat
	XG/S=PG/S:按键方式为侧拨	XG/S=PG/S:key is side

3. 产品位数代号 NUMBER OF POSITIONS

02	03	04	05	06	07	08	09	10	12
二位	三位	四位	五位	六位	七位	八位	九位	十位	十二位
two	three	four	five	six	seven	eight	nine	ten	twelve

4. 电气性能 ELECTRICAL CHARACTERISTICS

项目 ITME		性能 PERFORMANCE
4.1	接触电阻(初始值) CONTACT RESISTANCE (INITIAL) :	≤50mΩ
4.2	接触电阻(测试后) (AFTER LIFE TEST) :	≤100mΩ
4.3	开关容量(开关常切换) CONTACT RATING (CONTACT RATING) :	25mA 24VDC
4.4	开关容量(开关不常切换) CONTACT RATING (NON-CONTACT RATING) :	100mA
4.5	绝缘电阻 INSULATION RESISTANCE:	≥100MΩ .Min.at 500VDC
4.6	耐压强度 DIELECTRIC STRENGTH:	500VAC Min. for 60 seconds. 1mA
4.7	极际电容 CAPACITANCE BETWEEN ADJACENT SWITCHES:	≤5PF



5. 机械特性 MECHANICAL

项目 ITME		性能 PERFORMANCE
5.1	操作力 OPERATION FORCE:	≤8N
5.2	机械寿命 MECHANICAL LIFE:	2000 operations
5.3	使用温度 OPERATING TEMPERATURE:	-20℃ ~ +70℃
5.4	储存温度 STORAGE TEMPERATURE:	-40℃ ~ +85℃
5.5	可焊性 SOLDERABILITY:	After flux 230±5℃for 5 ±0.5seconds, 95%coverage



制品规格 SPECIFICATIONS OF PRODUCTS

文件编号 DOCUMENT NO.	DW-SP-014-07	发行日期 ISSUED DATE	2012-4-17	版本: 2.0 VERSION	页次: 3/3 PAGE
项目 ITME					性能 PERFORMANCE
5.6	耐焊接热 RESISTANCE TO SOLDERING HEAT:			260±5°C for 5±1seconds	



6. 焊接和清洗 SOLDERING AND CLEANING PROCESSES

6.1	在所有操作过程中, 请确保开关在OFF位置	Keep all switch contacts in their "OFF" position for all operations
6.2	波焊: 推荐焊接焊锡温度为500° F(260°C), 最多5秒	WAVE SOLDERING: Recommended solder temperature at 500° F(260°C) max.5 seconds
6.3	手焊: 使用30W烙铁控制温度在350°C, 焊接时间大约5秒钟	HAND SOLDERING: Use a soldering iron of 30 Watts controlled at 350°C approximately 5 seconds. While

7. 产品包装 PACKING

7.1	所有拨码产品皆以IC管形式包装 VPG/S系列包装资料	All Code Switches are shipped in standard IC tube Packing of VPG/S

系列 SERIES	开关位数 NO. of POS	每管数量 PER TUBE	每小箱数量 PER BOX	外箱包装 PER CTN
VPG/S	2	72PCS	6480PCS	6 BOXES 55.5×30.5×40CM
VPG/S	3	52PCS	4680PCS	
VPG/S	4	40PCS	3600PCS	
VPG/S	5	33PCS	2970PCS	
VPG/S	6	28PCS	2520PCS	
VPG/S	7	24PCS	2160PCS	
VPG/S	8	21PCS	1890PCS	
VPG/S	9	19PCS	1710PCS	
VPG/S	10	17PCS	1530PCS	
VPG/S	12	14PCS	1260PCS	

8. 产品外形及装配图纸 SHAPE AND ASSEMBLY SIZE

DIMENSION A (General tolerance: ±0.3)

POSITIONS	2	3	4	5	6	7	8	9	10	12
A	6.62	9.16	11.7	14.24	16.78	19.32	21.86	24.4	26.94	32.02

ITEM	DES	MATERIALS	TREATMENT
1	COVER	ENGINEERING PLASTICS	RED, BLUE, BLACK
2	BASE	ENGINEERING PLASTICS	BLACK
3	KEY	ENGINEERING PLASTICS	WHITE
4	TERMINAL	ALLOY COPPER	PLATING GOLD

VPG DIMENSIONS Unit:mm

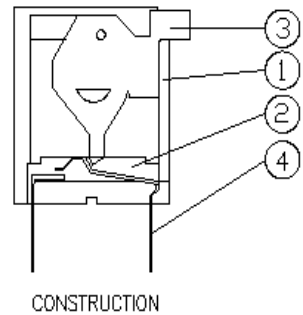
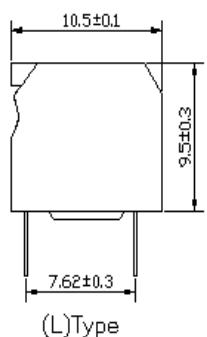
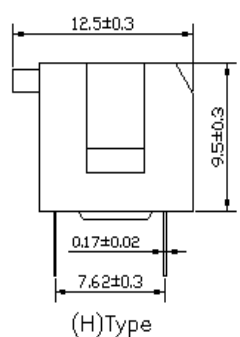
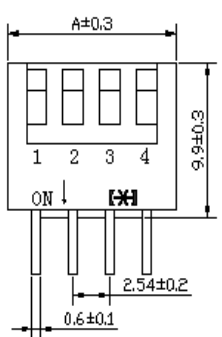
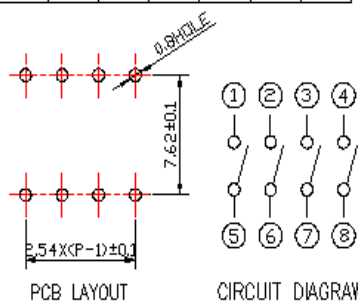
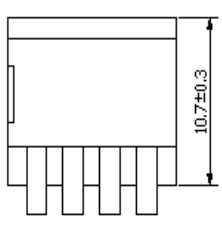

【*】[®] 慈溪市东威电子有限公司
CIXI CITY DONGWEI ELECTRONICS CO., LTD

SPECIFICATION



客 户
 CUSTOMER: _____

品 名
 TITLE: 拨码开关 (DIP SWITCH)

型 号
 PART ON.: VPG/S-08H-R

客 户 型 号
 CUSTOMER PART NO.: _____

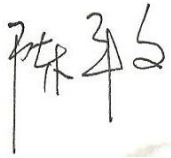
日 期
 DATE: _____

制 样 DESIGNED BY	审 核 CHECKED BY	批 准 APPROVED BY	送样印 SENDING PRINT
	Alice		
客 户 确 认 CUSTOMER APPROVAL		承 认 印 APPD PRINT	

地址: 浙江省慈溪市逍林青春路245号
 Add: No#245 qingchun road, xiaolin, cixi, zhejiang
 电话(Tel): +86-574-63501386 63501528
 传真(Fax): +86-574-63500156
 邮编(P. C.): 315321
[Http://www.tonver.com](http://www.tonver.com)
 E-mail: tonver@tonver.com



制品规格 SPECIFICATIONS OF PRODUCTS

文件编号 DOCUMENT NO.	DW-SP-014-08	发行日期 ISSUED DATE	2012-4-17	版本: 2.0 VERSION	页次: 2/3 PAGE
----------------------	--------------	---------------------	-----------	--------------------	-----------------

1. 材料 MATERIALS

	上盖: 工程塑料, 红色、蓝色、黑色	COVER: Engineering Plastics, Red、Blue、Black
	底座: 工程塑料, 黑色	BASE: Engineering Plastics, Black
	按键: 工程塑料, 白色	KEY: Engineering Plastics, White
	端子: 铜合金, 镀金或者镀银	TERMINAL: Alloy Copper, Plating Gold or Ag

2. 产品命名 PRODUCT NAMING

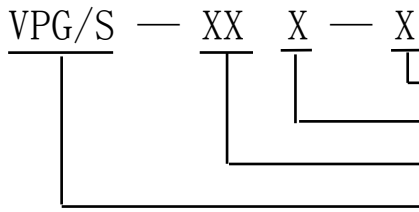

R为环保型 0为普通型 R:rohs 0:common
 外壳颜色:H:为红色 L:为蓝色 B:为黑色 Color: H:red L:blue B:black
 产品位数 Position of product
 V系列 V series
 XG/S=DG/S:按键方式为平拨 XG/S=DG/S:key is flat
 XG/S=PG/S:按键方式为侧拨 XG/S=PG/S:key is side

3. 产品位数代号 NUMBER OF POSITIONS

02	03	04	05	06	07	08	09	10	12
二位	三位	四位	五位	六位	七位	八位	九位	十位	十二位
two	three	four	five	six	seven	eight	nine	ten	twelve

4. 电气性能 ELECTRICAL CHARACTERISTICS

项目 ITME		性能 PERFORMANCE
4.1	接触电阻(初始值) CONTACT RESISTANCE (INITIAL) :	≤50mΩ
4.2	接触电阻(测试后) (AFTER LIFE TEST) :	≤100mΩ
4.3	开关容量(开关常切换) CONTACT RATING (CONTACT RATING) :	25mA 24VDC
4.4	开关容量(开关不常切换) CONTACT RATING (NON-CONTACT RATING) :	100mA
4.5	绝缘电阻 INSULATION RESISTANCE:	≥100MΩ .Min.at 500VDC
4.6	耐压强度 DIELECTRIC STRENGTH:	500VAC Min. for 60 seconds. 1mA
4.7	极际电容 CAPACITANCE BETWEEN ADJACENT SWITCHES:	≤5PF



5. 机械特性 MECHANICAL

项目 ITME		性能 PERFORMANCE
5.1	操作力 OPERATION FORCE:	≤8N
5.2	机械寿命 MECHANICAL LIFE:	2000 operations
5.3	使用温度 OPERATING TEMPERATURE:	-20℃ ~ +70℃
5.4	储存温度 STORAGE TEMPERATURE:	-40℃ ~ +85℃
5.5	可焊性 SOLDERABILITY:	After flux 230±5℃for 5 ±0.5seconds, 95%coverage



制品规格 SPECIFICATIONS OF PRODUCTS

文件编号 DOCUMENT NO.	DW-SP-014-08	发行日期 ISSUED DATE	2012-4-17	版本: 2.0 VERSION	页次: 3/3 PAGE
项目 ITME				性能 PERFORMANCE	
5.6	耐焊接热 RESISTANCE TO SOLDERING HEAT:			260±5°C for 5±1seconds	



6. 焊接和清洗 SOLDERING AND CLEANING PROCESSES

6.1	在所有操作过程中, 请确保开关在OFF位置	Keep all switch contacts in their "OFF" position for all operations
6.2	波焊: 推荐焊接焊锡温度为500° F(260°C), 最多5秒	WAVE SOLDERING: Recommended solder temperature at 500° F(260°C) max.5 seconds
6.3	手焊: 使用30W烙铁控制温度在350°C, 焊接时间大约5秒钟	HAND SOLDERING: Use a soldering iron of 30 Watts controlled at 350°C approximately 5 seconds. While

7. 产品包装 PACKING

7.1	所有拨码产品皆以IC管形式包装 VPG/S系列包装资料	<table border="1"> <thead> <tr> <th>系列 SERIES</th> <th>开关位数 NO.of POS</th> <th>每管数量 PER TUBE</th> <th>每小箱数量 PER BOX</th> <th>外箱包装 PER CTN</th> </tr> </thead> <tbody> <tr><td>VPG/S</td><td>2</td><td>72PCS</td><td>6480PCS</td><td rowspan="10">6 BOXES 55.5×30.5×40CM</td></tr> <tr><td>VPG/S</td><td>3</td><td>52PCS</td><td>4680PCS</td></tr> <tr><td>VPG/S</td><td>4</td><td>40PCS</td><td>3600PCS</td></tr> <tr><td>VPG/S</td><td>5</td><td>33PCS</td><td>2970PCS</td></tr> <tr><td>VPG/S</td><td>6</td><td>28PCS</td><td>2520PCS</td></tr> <tr><td>VPG/S</td><td>7</td><td>24PCS</td><td>2160PCS</td></tr> <tr><td>VPG/S</td><td>8</td><td>21PCS</td><td>1890PCS</td></tr> <tr><td>VPG/S</td><td>9</td><td>19PCS</td><td>1710PCS</td></tr> <tr><td>VPG/S</td><td>10</td><td>17PCS</td><td>1530PCS</td></tr> <tr><td>VPG/S</td><td>12</td><td>14PCS</td><td>1260PCS</td></tr> </tbody> </table>	系列 SERIES	开关位数 NO.of POS	每管数量 PER TUBE	每小箱数量 PER BOX	外箱包装 PER CTN	VPG/S	2	72PCS	6480PCS	6 BOXES 55.5×30.5×40CM	VPG/S	3	52PCS	4680PCS	VPG/S	4	40PCS	3600PCS	VPG/S	5	33PCS	2970PCS	VPG/S	6	28PCS	2520PCS	VPG/S	7	24PCS	2160PCS	VPG/S	8	21PCS	1890PCS	VPG/S	9	19PCS	1710PCS	VPG/S	10	17PCS	1530PCS	VPG/S	12	14PCS	1260PCS	All Code Switches are shipped in standard IC tube Packing of VPG/S
			系列 SERIES	开关位数 NO.of POS	每管数量 PER TUBE	每小箱数量 PER BOX	外箱包装 PER CTN																																										
			VPG/S	2	72PCS	6480PCS	6 BOXES 55.5×30.5×40CM																																										
			VPG/S	3	52PCS	4680PCS																																											
			VPG/S	4	40PCS	3600PCS																																											
			VPG/S	5	33PCS	2970PCS																																											
			VPG/S	6	28PCS	2520PCS																																											
			VPG/S	7	24PCS	2160PCS																																											
			VPG/S	8	21PCS	1890PCS																																											
			VPG/S	9	19PCS	1710PCS																																											
VPG/S	10	17PCS	1530PCS																																														
VPG/S	12	14PCS	1260PCS																																														

8. 产品外形及装配图纸 SHAPE AND ASSEMBLY SIZE

DIMENSION A (General tolerance: ±0.3)

POSITIONS	2	3	4	5	6	7	8	9	10	12
A	6.62	9.16	11.7	14.24	16.78	19.32	21.86	24.4	26.94	32.02

ITEM	DES	MATERIALS	TREATMENT
1	COVER	ENGINEERING PLASTICS	RED, BLUE, BLACK
2	BASE	ENGINEERING PLASTICS	BLACK
3	KEY	ENGINEERING PLASTICS	WHITE
4	TERMINAL	ALLOY COPPER	PLATING GOLD

VPG DIMENSIONS Unit:mm

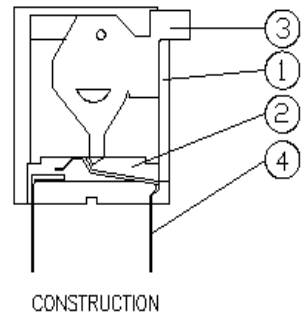
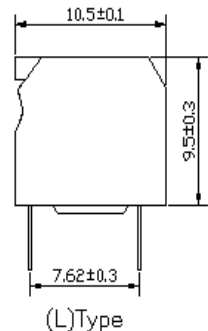
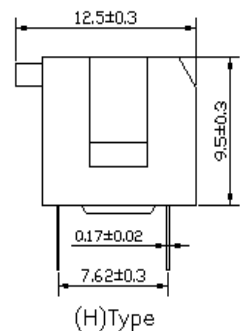
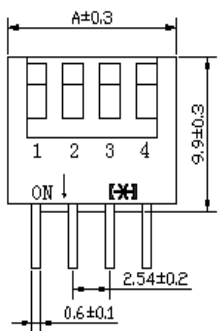
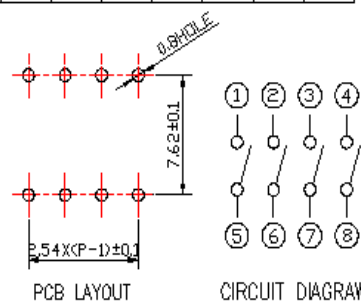
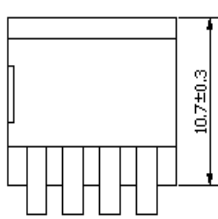

【*】[®] 慈溪市东威电子有限公司

CIXI CITY DONGWEI ELECTRONICS CO., LTD

SPECIFICATION

客 户

CUSTOMER: _____

品 名

TITLE: _____

拨码开关 (DIP SWITCH)

型 号

PART ON. : _____





VPG/S-09H-R

客 户 型 号

CUSTOMER PART NO. : _____

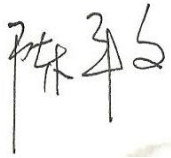
日 期

DATE: _____

制 样 DESIGNED BY	审 核 CHECKED BY	批 准 APPROVED BY	送样印 SENDING PRINT
			
客 户 确 认 CUSTOMER APPROVAL		承 认 印 APPD PRINT	
_____		_____	

地址：浙江省慈溪市逍林青春路245号

Add: No#245 qingchun road, xiaolin, cixi, zhejiang

电话(Tel): +86-574-63501386 63501528

传真(Fax): +86-574-63500156

邮编(P. C.): 315321

[Http://www.tonver.com](http://www.tonver.com)

E-mail: tonver@tonver.com



制品规格 SPECIFICATIONS OF PRODUCTS

文件编号 DOCUMENT NO.	DW-SP-014-09	发行日期 ISSUED DATE	2012-4-17	版本: 2.0 VERSION	页次: 2/3 PAGE
----------------------	--------------	---------------------	-----------	--------------------	-----------------

1. 材料 MATERIALS

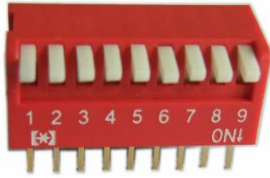

上盖: 工程塑料, 红色、蓝色、黑色 COVER: Engineering Plastics, Red、Blue、Black
底座: 工程塑料, 黑色 BASE: Engineering Plastics, Black
按键: 工程塑料, 白色 KEY: Engineering Plastics, White
端子: 铜合金, 镀金或者镀银 TERMINAL: Alloy Coper, Plating Gold or Ag

2. 产品命名 PRODUCT NAMING

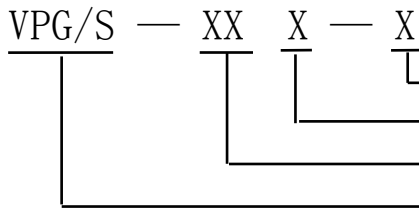

R为环保型 0为普通型 R:rohs 0:common
 外壳颜色:H:为红色 L:为蓝色 B:为黑色 Color: H:red L:blue B:black
 产品位数 Position of product
 V系列 V series
 XG/S=DG/S:按键方式为平拨 XG/S=DG/S:key is flat
 XG/S=PG/S:按键方式为侧拨 XG/S=PG/S:key is side

3. 产品位数代号 NUMBER OF POSITIONS

02	03	04	05	06	07	08	09	10	12
二位 two	三位 three	四位 four	五位 five	六位 six	七位 seven	八位 eight	九位 nine	十位 ten	十二位 twelve

4. 电气性能 ELECTRICAL CHARACTERISTICS



项目 ITME		性能 PERFORMANCE
4.1	接触电阻(初始值) CONTACT RESISTANCE (INITIAL) :	≤50mΩ
4.2	接触电阻(测试后) (AFTER LIFE TEST) :	≤100mΩ
4.3	开关容量(开关常切换) CONTACT RATING (CONTACT RATING) :	25mA 24VDC
4.4	开关容量(开关不常切换) CONTACT RATING (NON-CONTACT RATING) :	100mA
4.5	绝缘电阻 INSULATION RESISTANCE:	≥100MΩ .Min.at 500VDC
4.6	耐压强度 DIELECTRIC STRENGTH:	500VAC Min. for 60 seconds. 1mA
4.7	极际电容 CAPACITANCE BETWEEN ADJACENT SWITCHES:	≤5PF

5. 机械特性 MECHANICAL

项目 ITME		性能 PERFORMANCE
5.1	操作力 OPERATION FORCE:	≤8N
5.2	机械寿命 MECHANICAL LIFE:	2000 operations
5.3	使用温度 OPERATING TEMPERATURE:	-20℃ ~ +70℃
5.4	储存温度 STORAGE TEMPERATURE:	-40℃ ~ +85℃
5.5	可焊性 SOLDERABILITY:	After flux 230±5℃for 5 ±0.5seconds, 95%coverage



制品规格 SPECIFICATIONS OF PRODUCTS

文件编号 DOCUMENT NO.	DW-SP-014-09	发行日期 ISSUED DATE	2012-4-17	版本: 2.0 VERSION	页次: 3/3 PAGE
项目 ITME				性能 PERFORMANCE	
5.6	耐焊接热 RESISTANCE TO SOLDERING HEAT:			260±5°C for 5±1seconds	



6. 焊接和清洗 SOLDERING AND CLEANING PROCESSES

6.1	在所有操作过程中, 请确保开关在OFF位置	Keep all switch contacts in their "OFF" position for all operations
6.2	波焊: 推荐焊接焊锡温度为500° F(260°C), 最多5秒	WAVE SOLDERING: Recommended solder temperature at 500° F(260°C) max.5 seconds
6.3	手焊: 使用30W烙铁控制温度在350°C, 焊接时间大约5秒钟	HAND SOLDERING: Use a soldering iron of 30 Watts controlled at 350°C approximately 5 seconds. While

7. 产品包装 PACKING

7.1	所有拨码产品皆以IC管形式包装 VPG/S系列包装资料	All Code Switches are shipped in standard IC tube Packing of VPG/S

系列 SERIES	开关位数 NO. of POS	每管数量 PER TUBE	每小箱数量 PER BOX	外箱包装 PER CTN
VPG/S	2	72PCS	6480PCS	6 BOXES 55.5×30.5×40CM
VPG/S	3	52PCS	4680PCS	
VPG/S	4	40PCS	3600PCS	
VPG/S	5	33PCS	2970PCS	
VPG/S	6	28PCS	2520PCS	
VPG/S	7	24PCS	2160PCS	
VPG/S	8	21PCS	1890PCS	
VPG/S	9	19PCS	1710PCS	
VPG/S	10	17PCS	1530PCS	
VPG/S	12	14PCS	1260PCS	

8. 产品外形及装配图纸 SHAPE AND ASSEMBLY SIZE

DIMENSION A (General tolerance: ±0.3)

POSITIONS	2	3	4	5	6	7	8	9	10	12
A	6.62	9.16	11.7	14.24	16.78	19.32	21.86	24.4	26.94	32.02

ITEM	DES	MATERIALS	TREATMENT
1	COVER	ENGINEERING PLASTICS	RED, BLUE, BLACK
2	BASE	ENGINEERING PLASTICS	BLACK
3	KEY	ENGINEERING PLASTICS	WHITE
4	TERMINAL	ALLOY COPPER	PLATING GOLD

VPG DIMENSIONS Unit:mm

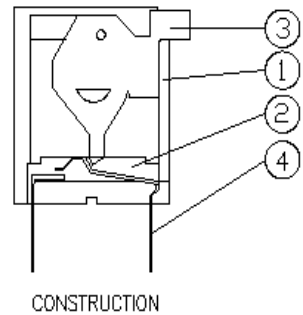
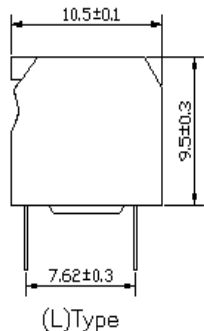
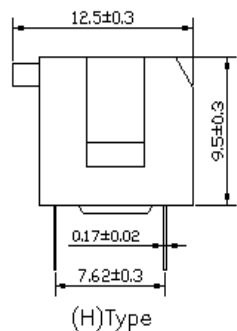
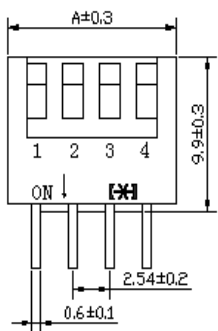
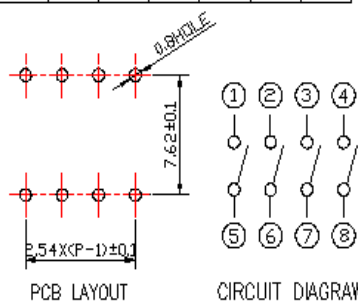
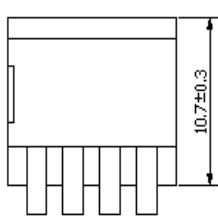

【*】[®] 慈溪市东威电子有限公司

CIXI CITY DONGWEI ELECTRONICS CO., LTD

SPECIFICATION

客 户

CUSTOMER: _____

品 名

TITLE: _____

拨码开关 (DIP SWITCH)

型 号

PART ON. : _____





VPG/S-10H-R

客 户 型 号

CUSTOMER PART NO. : _____

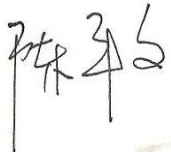
日 期

DATE: _____

制 样 DESIGNED BY	审 核 CHECKED BY	批 准 APPROVED BY	送样印 SENDING PRINT
			
客 户 确 认 CUSTOMER APPROVAL		承 认 印 APPD PRINT	
_____		_____	

地址：浙江省慈溪市逍林青春路245号

Add:No#245 qingchun road,xiaolin,cixi,zhejiang

电话(Tel):+86-574-63501386 63501528

传真(Fax):+86-574-63500156

邮编(P. C.):315321

[Http://www.tonver.com](http://www.tonver.com)

E-mail:tonver@tonver.com



制品规格 SPECIFICATIONS OF PRODUCTS

文件编号 DOCUMENT NO.	DW-SP-014-10	发行日期 ISSUED DATE	2012-4-17	版本: 2.0 VERSION	页次: 2/3 PAGE
----------------------	--------------	---------------------	-----------	--------------------	-----------------

1. 材料 MATERIALS

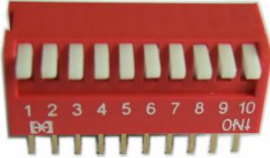
	上盖: 工程塑料, 红色、蓝色、黑色	COVER: Engineering Plastics, Red、Blue、Black
	底座: 工程塑料, 黑色	BASE: Engineering Plastics, Black
	按键: 工程塑料, 白色	KEY: Engineering Plastics, White
	端子: 铜合金, 镀金或者镀银	TERMINAL: Alloy Copper, Plating Gold or Ag

2. 产品命名 PRODUCT NAMING

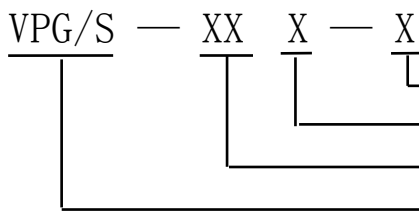

R为环保型 0为普通型 R:rohs 0:common
 外壳颜色:H:为红色 L:为蓝色 B:为黑色 Color: H:red L:blue B:black
 产品位数 Position of product
 V系列 V series
 XG/S=DG/S:按键方式为平拨 XG/S=DG/S:key is flat
 XG/S=PG/S:按键方式为侧拨 XG/S=PG/S:key is side

3. 产品位数代号 NUMBER OF POSITIONS

02	03	04	05	06	07	08	09	10	12
二位	三位	四位	五位	六位	七位	八位	九位	十位	十二位
two	three	four	five	six	seven	eight	nine	ten	twelve

4. 电气性能 ELECTRICAL CHARACTERISTICS

项目 ITME		性能 PERFORMANCE
4.1	接触电阻(初始值) CONTACT RESISTANCE (INITIAL) :	≤50mΩ
4.2	接触电阻(测试后) (AFTER LIFE TEST) :	≤100mΩ
4.3	开关容量(开关常切换) CONTACT RATING (CONTACT RATING) :	25mA 24VDC
4.4	开关容量(开关不常切换) CONTACT RATING (NON-CONTACT RATING) :	100mA
4.5	绝缘电阻 INSULATION RESISTANCE:	≥100MΩ .Min.at 500VDC
4.6	耐压强度 DIELECTRIC STRENGTH:	500VAC Min. for 60 seconds. 1mA
4.7	极际电容 CAPACITANCE BETWEEN ADJACENT SWITCHES:	≤5PF



5. 机械特性 MECHANICAL

项目 ITME		性能 PERFORMANCE
5.1	操作力 OPERATION FORCE:	≤8N
5.2	机械寿命 MECHANICAL LIFE:	2000 operations
5.3	使用温度 OPERATING TEMPERATURE:	-20℃ ~ +70℃
5.4	储存温度 STORAGE TEMPERATURE:	-40℃ ~ +85℃
5.5	可焊性 SOLDERABILITY:	After flux 230±5℃for 5 ±0.5seconds, 95%coverage



制品规格 SPECIFICATIONS OF PRODUCTS

文件编号 DOCUMENT NO.	DW-SP-014-10	发行日期 ISSUED DATE	2012-4-17	版本: 2.0 VERSION	页次: 3/3 PAGE
项目 ITME				性能 PERFORMANCE	
5.6	耐焊接热 RESISTANCE TO SOLDERING HEAT:			260±5°C for 5±1seconds	



6. 焊接和清洗 SOLDERING AND CLEANING PROCESSES

6.1	在所有操作过程中, 请确保开关在OFF位置	Keep all switch contacts in their "OFF" position for all operations
6.2	波焊: 推荐焊接焊锡温度为500° F(260°C), 最多5秒	WAVE SOLDERING: Recommended solder temperature at 500° F(260°C) max.5 seconds
6.3	手焊: 使用30W烙铁控制温度在350°C, 焊接时间大约5秒钟	HAND SOLDERING: Use a soldering iron of 30 Watts controlled at 350°C approximately 5 seconds. While

7. 产品包装 PACKING

7.1	所有拨码产品皆以IC管形式包装 VPG/S系列包装资料	All Code Switches are shipped in standard IC tube Packing of VPG/S

系列 SERIES	开关位数 NO. of POS	每管数量 PER TUBE	每小箱数量 PER BOX	外箱包装 PER CTN
VPG/S	2	72PCS	6480PCS	6 BOXES 55.5×30.5×40CM
VPG/S	3	52PCS	4680PCS	
VPG/S	4	40PCS	3600PCS	
VPG/S	5	33PCS	2970PCS	
VPG/S	6	28PCS	2520PCS	
VPG/S	7	24PCS	2160PCS	
VPG/S	8	21PCS	1890PCS	
VPG/S	9	19PCS	1710PCS	
VPG/S	10	17PCS	1530PCS	
VPG/S	12	14PCS	1260PCS	

8. 产品外形及装配图纸 SHAPE AND ASSEMBLY SIZE

DIMENSION A (General tolerance: ±0.3)

POSITIONS	2	3	4	5	6	7	8	9	10	12
A	6.62	9.16	11.7	14.24	16.78	19.32	21.86	24.4	26.94	32.02

ITEM	DES	MATERIALS	TREATMENT
1	COVER	ENGINEERING PLASTICS	RED, BLUE, BLACK
2	BASE	ENGINEERING PLASTICS	BLACK
3	KEY	ENGINEERING PLASTICS	WHITE
4	TERMINAL	ALLOY COPPER	PLATING GOLD

VPG DIMENSIONS Unit:mm

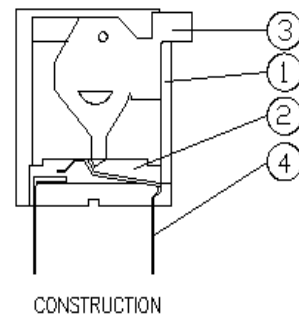
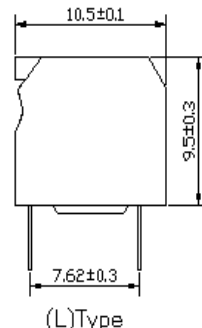
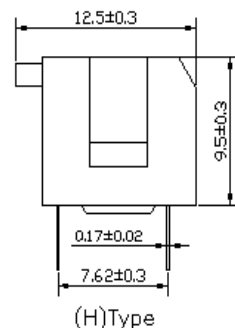
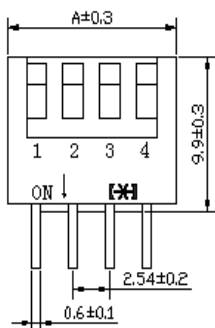
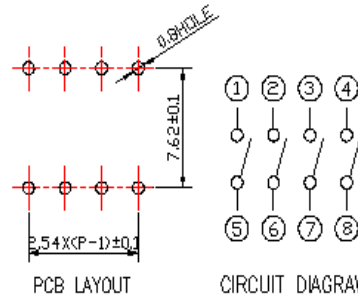
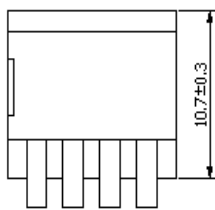

【*】[®] 慈溪市东威电子有限公司
CIXI CITY DONGWEI ELECTRONICS CO., LTD

SPECIFICATION

客 户
CUSTOMER: _____

品 名
TITLE: 拨码开关 (DIP SWITCH) _____

型 号
PART ON.: VPG/S-12H-R _____

客 户 型 号
CUSTOMER PART NO.: _____

日 期
DATE: _____

制 样 DESIGNED BY	审 核 CHECKED BY	批 准 APPROVED BY	送样印 SENDING PRINT
陈平	Alice	Jaipei	
客 户 确 认 CUSTOMER APPROVAL		承 认 印 APPD PRINT	

地址：浙江省慈溪市逍林青春路245号
 Add: No#245 qingchun road, xiaolin, cixi, zhejiang
 电话(Tel): +86-574-63501386 63501528
 传真(Fax): +86-574-63500156
 邮编(P. C.): 315321
[Http://www.tonver.com](http://www.tonver.com)
 E-mail: tonver@tonver.com



制品规格 SPECIFICATIONS OF PRODUCTS

文件编号 DOCUMENT NO.	DW-SP-014-12	发行日期 ISSUED DATE	2012-4-17	版本: 2.0 VERSION	页次: 2/3 PAGE
----------------------	--------------	---------------------	-----------	--------------------	-----------------

1. 材料 MATERIALS

	上盖: 工程塑料, 红色、蓝色、黑色 COVER: Engineering Plastics, Red、Blue、Black
	底座: 工程塑料, 黑色 BASE: Engineering Plastics, Black
	按键: 工程塑料, 白色 KEY: Engineering Plastics, White
	端子: 铜合金, 镀金或者镀银 TERMINAL: Alloy Copper, Plating Gold or Ag

2. 产品命名 PRODUCT NAMING

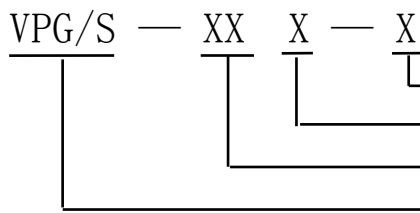

R为环保型 0为普通型 R:rohs 0:common
 外壳颜色:H:为红色 L:为蓝色 B:为黑色 Color: H:red L:blue B:black
 产品位数 Position of product
 V系列 V series
 XG/S=DG/S:按键方式为平拨 XG/S=DG/S:key is flat
 XG/S=PG/S:按键方式为侧拨 XG/S=PG/S:key is side

3. 产品位数代号 NUMBER OF POSITIONS

02	03	04	05	06	07	08	09	10	12
二位 two	三位 three	四位 four	五位 five	六位 six	七位 seven	八位 eight	九位 nine	十位 ten	十二位 twelve

4. 电气性能 ELECTRICAL CHARACTERISTICS

项目 ITME		性能 PERFORMANCE
4.1	接触电阻(初始值) CONTACT RESISTANCE (INITIAL) :	≤50mΩ
4.2	接触电阻(测试后) (AFTER LIFE TEST) :	≤100mΩ
4.3	开关容量(开关常切换) CONTACT RATING (CONTACT RATING) :	25mA 24VDC
4.4	开关容量(开关不常切换) CONTACT RATING (NON-CONTACT RATING) :	100mA
4.5	绝缘电阻 INSULATION RESISTANCE:	≥100MΩ .Min.at 500VDC
4.6	耐压强度 DIELECTRIC STRENGTH:	500VAC Min. for 60 seconds. 1mA
4.7	极际电容 CAPACITANCE BETWEEN ADJACENT SWITCHES:	≤5PF



5. 机械特性 MECHANICAL

项目 ITME		性能 PERFORMANCE
5.1	操作力 OPERATION FORCE:	≤8N
5.2	机械寿命 MECHANICAL LIFE:	2000 operations
5.3	使用温度 OPERATING TEMPERATURE:	-20℃ ~ +70℃
5.4	储存温度 STORAGE TEMPERATURE:	-40℃ ~ +85℃
5.5	可焊性 SOLDERABILITY:	After flux 230±5℃for 5 ±0.5seconds, 95%coverage



制品规格 SPECIFICATIONS OF PRODUCTS

文件编号 DOCUMENT NO.	DW-SP-014-12	发行日期 ISSUED DATE	2012-4-17	版本: 2.0 VERSION	页次: 3/3 PAGE
项目 ITME				性能 PERFORMANCE	
5.6	耐焊接热 RESISTANCE TO SOLDERING HEAT:			260±5°C for 5±1seconds	



6. 焊接和清洗 SOLDERING AND CLEANING PROCESSES

6.1	在所有操作过程中, 请确保开关在OFF位置	Keep all switch contacts in their "OFF" position for all operations
6.2	波焊: 推荐焊接焊锡温度为500° F(260°C), 最多5秒	WAVE SOLDERING: Recommended solder temperature at 500° F(260°C) max.5 seconds
6.3	手焊: 使用30W烙铁控制温度在350°C, 焊接时间大约5秒钟	HAND SOLDERING: Use a soldering iron of 30 Watts controlled at 350°C approximately 5 seconds. While

7. 产品包装 PACKING

7.1	所有拨码产品皆以IC管形式包装 VPG/S系列包装资料	All Code Switches are shipped in standard IC tube Packing of VPG/S

系列 SERIES	开关位数 NO. of POS	每管数量 PER TUBE	每小箱数量 PER BOX	外箱包装 PER CTN
VPG/S	2	72PCS	6480PCS	6 BOXES 55.5×30.5×40CM
VPG/S	3	52PCS	4680PCS	
VPG/S	4	40PCS	3600PCS	
VPG/S	5	33PCS	2970PCS	
VPG/S	6	28PCS	2520PCS	
VPG/S	7	24PCS	2160PCS	
VPG/S	8	21PCS	1890PCS	
VPG/S	9	19PCS	1710PCS	
VPG/S	10	17PCS	1530PCS	
VPG/S	12	14PCS	1260PCS	

8. 产品外形及装配图纸 SHAPE AND ASSEMBLY SIZE

DIMENSION A (General tolerance: ±0.3)

POSITIONS	2	3	4	5	6	7	8	9	10	12
A	6.62	9.16	11.7	14.24	16.78	19.32	21.86	24.4	26.94	32.02

ITEM	DES	MATERIALS	TREATMENT
1	COVER	ENGINEERING PLASTICS	RED, BLUE, BLACK
2	BASE	ENGINEERING PLASTICS	BLACK
3	KEY	ENGINEERING PLASTICS	WHITE
4	TERMINAL	ALLOY COPPER	PLATING GOLD

VPG DIMENSIONS Unit:mm

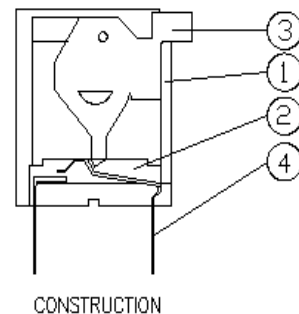
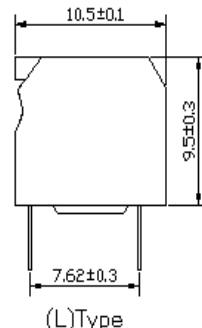
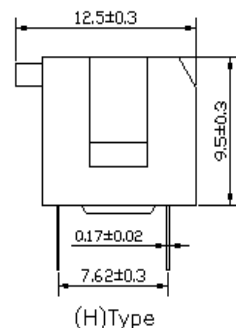
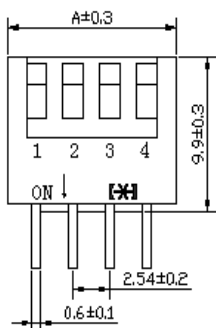
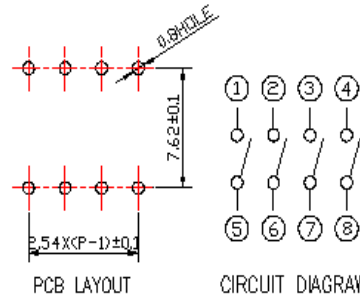
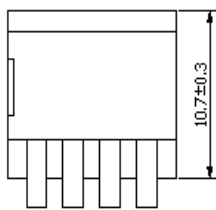

X-ON Electronics

Largest Supplier of Electrical and Electronic Components

Click to view similar products for [DIP Switches/SIP Switches](#) category:

Click to view products by [Cixi Tonver](#) manufacturer:

Other Similar products are found below :

[79B10T](#) [8136-475G4T](#) [G7G-1A2-CB-DC12](#) [H7CZL8AC100240](#) [DRR60016](#) [DRS4016](#) [1825008-1](#) [1825444-1](#) [200183](#) [206002](#) [219-6LPSTRF](#) [25.350.0653.0](#) [SBS 5004 TG](#) [SDA10H1BDA](#) [97R06ST](#) [A2C-2A5](#) [1825444-7](#) [ADE08SA04](#) [ADE12S04](#) [192960010](#) [206005RAS](#) [206007](#) [2-1825058-8](#) [25.330.0653.1](#) [25.352.0353.0](#) [CXDRIVEV2X](#) [IKN0600000](#) [IKN0800000](#) [LA2-002-DC24](#) [DRD10CRAE04](#) [DSR02T](#) [DSS 208 N](#) [E2FMX2D1M1TGJ03M](#) [NDI10H](#) [219-9MSTP](#) [EPM02FV](#) [206010RAST](#) [NDS08V](#) [76SB05](#) [TD06H0SK1](#) [Z7.255.9027.0](#) [1-1825058-3](#) [1825428-4](#) [219-10LPSTF](#) [E3ZG6111D03M](#) [G4D212PUSTV2DC5](#) [HARW0002](#) [EPG301BT06](#) [219-7LPSTRF](#) [1-1825058-6](#)