

**SOT-323 Plastic-Encapsulate MOSFETS**

**2N7002KW N-Channel MOSFET**

| $V_{(BR)DSS}$ | $R_{DS(on)MAX}$ | $I_D$ |
|---------------|-----------------|-------|
| 60V           | 2.5Ω@10V        | 340mA |
|               | 3Ω@4.5V         |       |

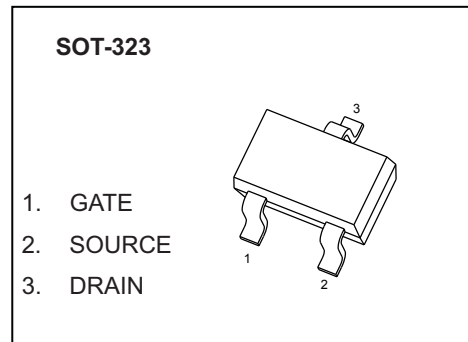

**FEATURE**

- High density cell design for Low  $R_{DS(on)}$
- Voltage controlled small signal switch
- Rugged and reliable
- High saturation current capability
- ESD protected

**APPLICATION**

- Load Switch for Portable Devices
- DC/DC Converter

**MARKING**

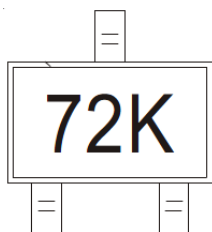

**Equivalent Circuit**

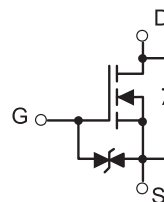

**MOSFET MAXIMUM RATINGS ( $T_a=25^{\circ}C$  unless otherwise noted)**

| Symbol          | Parameter                                   | Value    | Unit |
|-----------------|---|----------|------|
| $V_{DS}$        | Drain-Source Voltage                        | 60       | V    |
| $V_{GS}$        | Gate-Source Voltage                         | ±20      | V    |
| $I_D$           | Continuous Drain Current                    | 340      | mA   |
| $I_{DM}$        | Pulsed Drain Current(note1)                 | 800      | mA   |
| $P_D$           | Power Dissipation                           | 0.2      | W    |
| $T_j$           | Junction Temperature                        | 150      | °C   |
| $T_{stg}$       | Storage Temperature                         | -55~+150 | °C   |
| $R_{\theta JA}$ | Thermal Resistance from Junction to Ambient | 625      | °C/W |

## MOSFET ELECTRICAL CHARACTERISTICS

$T_a=25\text{ }^\circ\text{C}$  unless otherwise specified

| Parameter                             | Symbol        | Test Condition   | Min        | Typ | Max      | Unit     |
|---------------------------------------|---------------|--|------------|-----|----------|----------|
| <b>STATIC PARAMETERS</b>              |               |  |            |     |          |          |
| Drain-source Breakdown Voltage        | $V_{(BR)DSS}$ | $V_{GS} = 0V, I_D = 250\mu A$                              | 60         |     |          | V        |
| GateThreshold Voltage (note 2)        | $V_{GS(th)}$  | $V_{DS} = V_{GS}, I_D = 1mA$                               | 1          | 1.3 | 2.5      | V        |
| Zero Gate Voltage Drain Current       | $I_{DSS}$     | $V_{DS} = 48V, V_{GS} = 0V$                                |            |     | 1        | $\mu A$  |
| Gate-Source Leakage Current           | $I_{GSS}$     | $V_{GS} = \pm 20V, V_{DS} = 0V$                            |            |     | $\pm 10$ | $\mu A$  |
| Drain-Source On-Resistance (note 2)   | $R_{DS(on)}$  | $V_{GS} = 4.5V, I_D = 200mA$                               |            | 1.1 | 3        | $\Omega$ |
|                                       |               | $V_{GS} = 10V, I_D = 500mA$                                |            | 0.9 | 2.5      | $\Omega$ |
| <b>DYNAMIC PARAMETERS (note 3)</b>    |               |  |            |     |          |          |
| Input Capacitance                     | $C_{iss}$     | $V_{DS} = 10V, V_{GS} = 0V, f = 1MHz$                      |            |     | 40       | pF       |
| Output Capacitance                    | $C_{oss}$     |  |            |     | 30       | pF       |
| Reverse Transfer Capacitance          | $C_{rss}$     |  |            |     | 10       | pF       |
| <b>SWITCHING PARAMETERS (note 3)</b>  |               |  |            |     |          |          |
| Turn-on Delay Time                    | $t_{d(on)}$   | $V_{GS} = 10V, V_{DD} = 50V, R_G = 50\Omega$               |            |     | 10       | ns       |
| Turn-off Delay Time                   | $t_{d(off)}$  | $R_{GS} = 50\Omega, R_L = 250\Omega$                       |            |     | 15       | ns       |
| Reverse Recovery Time                 | $t_{rr}$      | $V_{GS} = 0V, I_S = 300mA, V_R = 25V, di/dt = -100A/\mu s$ |            | 30  |          | ns       |
| Recovered Charge                      | $Q_r$         | $V_{GS} = 0V, I_S = 300mA, V_R = 25V, di/dt = -100A/\mu s$ |            | 30  |          | nC       |
| <b>GATE-SOURCE ZENER DIODE</b>        |               |  |            |     |          |          |
| Gate-Source Breakdown Voltage         | $BV_{GSO}$    | $I_{GS} = \pm 1mA$ (Open Drain)                            | $\pm 21.5$ |     | $\pm 30$ | V        |
| <b>DRAIN-SOURCE DIODE</b>             |               |  |            |     |          |          |
| Diode Forward Voltage (note 2)        | $V_{SD}$      | $I_S = 300mA, V_{GS} = 0V$                                 |            |     | 1.5      | V        |
| Continuous Diode Forward Current      | $I_S$         |  |            |     | 0.2      | A        |
| Pulsed Diode Forward Current (note 1) | $I_{SM}$      |  |            |     | 0.53     | A        |

### Notes :

1. Repetitive rating: Pluse width limited by junction temperature.
2. Pulse Test : Pulse width  $\leq 300\mu s$ , duty cycle  $\leq 2\%$ .
3. Guaranteed by design, not subject to production testing.

# Typical Characteristics

### Output Characteristics

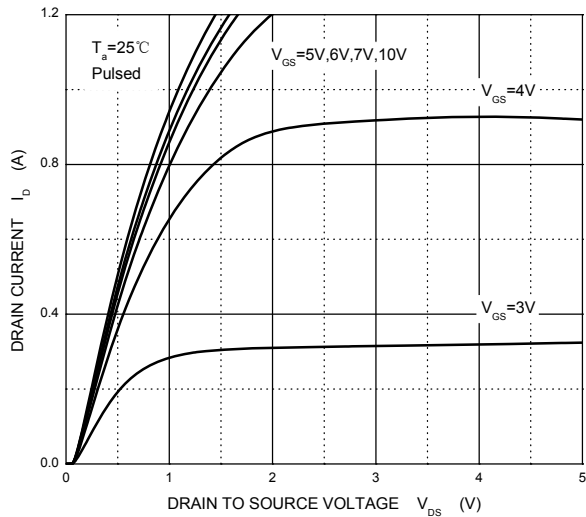

### Transfer Characteristics

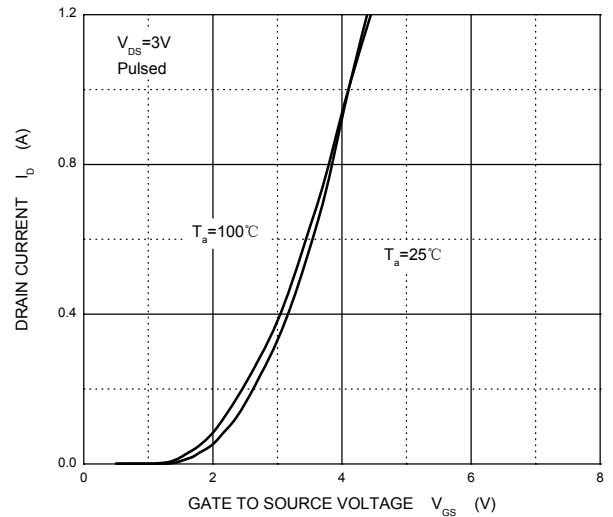

### $R_{DS(ON)}$ — $I_D$

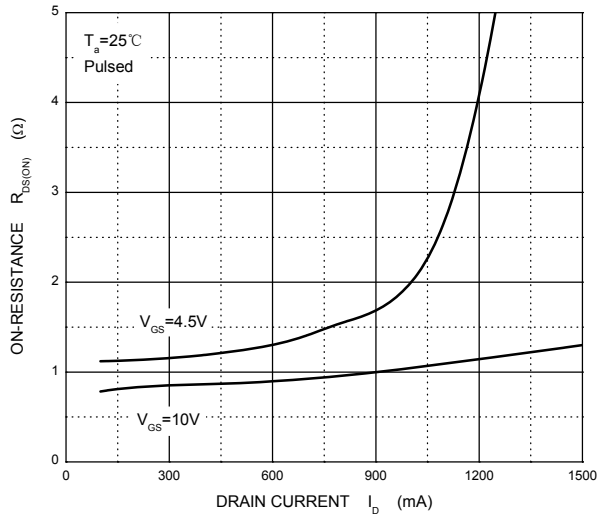

### $R_{DS(ON)}$ — $V_{GS}$

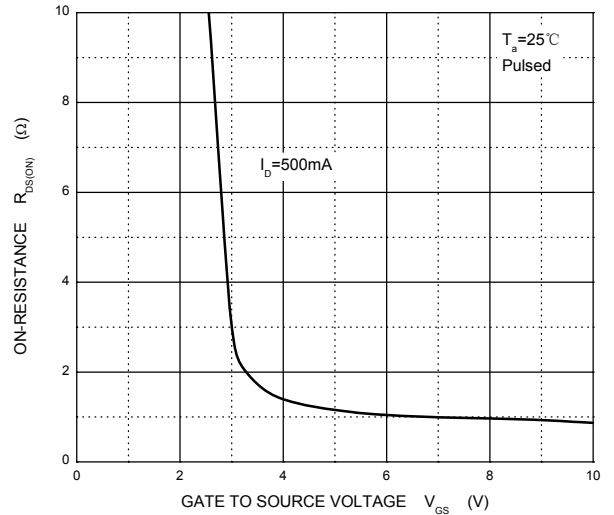

### $I_S$ — $V_{SD}$

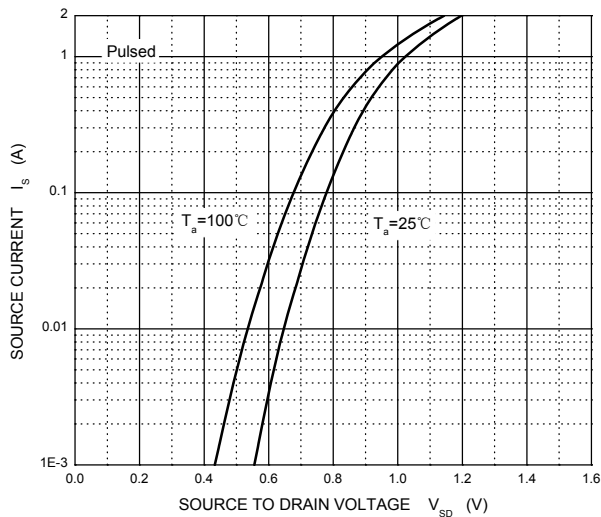

### Threshold Voltage

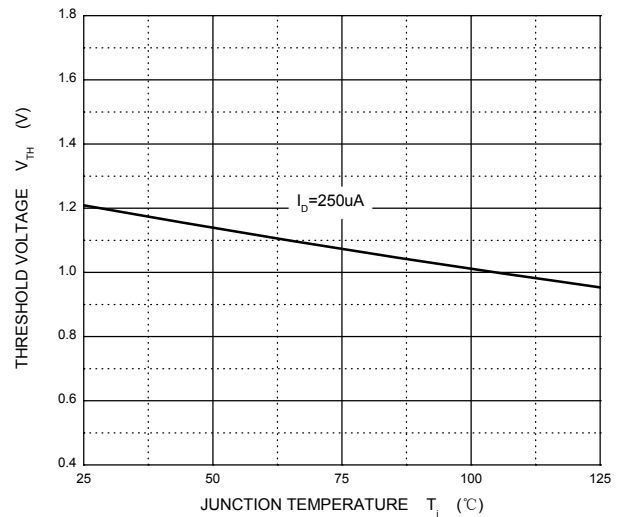

## SOT-323 Package Outline Dimensions

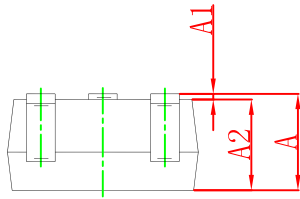
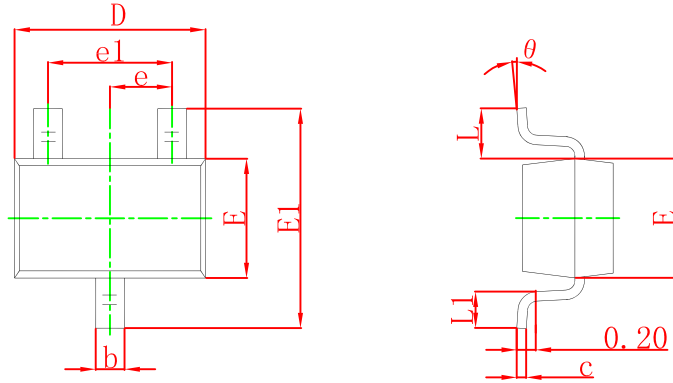

| Symbol   | Dimensions In Millimeters |       | Dimensions In Inches |       |
|----------|---------------------------|-------|----------------------|-------|
|          | Min                       | Max   | Min                  | Max   |
| A        | 0.900                     | 1.100 | 0.035                | 0.043 |
| A1       | 0.000                     | 0.100 | 0.000                | 0.004 |
| A2       | 0.900                     | 1.000 | 0.035                | 0.039 |
| b        | 0.200                     | 0.400 | 0.008                | 0.016 |
| c        | 0.080                     | 0.150 | 0.003                | 0.006 |
| D        | 2.000                     | 2.200 | 0.079                | 0.087 |
| E        | 1.150                     | 1.350 | 0.045                | 0.053 |
| E1       | 2.150                     | 2.450 | 0.085                | 0.096 |
| e        | 0.650 TYP                 |       | 0.026 TYP            |       |
| e1       | 1.200                     | 1.400 | 0.047                | 0.055 |
| L        | 0.525 REF                 |       | 0.021 REF            |       |
| L1       | 0.260                     | 0.460 | 0.010                | 0.018 |
| $\theta$ | 0°                        | 8°    | 0°                   | 8°    |

## SOT-323 Suggested Pad Layout

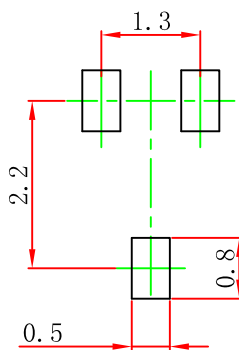

Note:

1. Controlling dimension: in millimeters.
2. General tolerance:  $\pm 0.05$  mm.
3. The pad layout is for reference purposes only.

### NOTICE

JSCJ reserves the right to make modifications, enhancements, improvements, corrections or other changes without further notice to any product herein. JSCJ does not assume any liability arising out of the application or use of any product described herein.

# SOT-323 Tape and Reel

## SOT-323 Embossed Carrier Tape

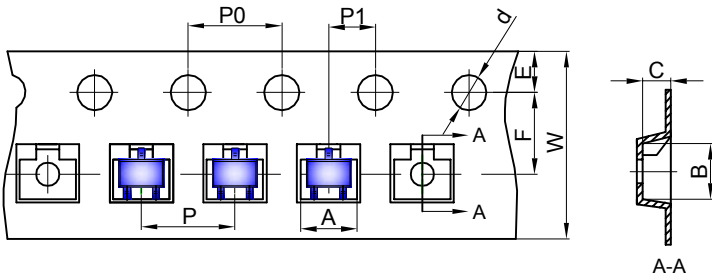

### Packaging Description:

SOT-323 parts are shipped in tape. The carrier tape is made from a dissipative (carbon filled) polycarbonate resin. The cover tape is a multilayer film (Heat Activated Adhesive in nature) primarily composed of polyester film, adhesive layer, sealant, and anti-static sprayed agent. These reeled parts in standard option are shipped with 3,000 units per 7" or 17.8cm diameter reel. The reels are clear in color and is made of polystyrene plastic (anti-static coated).

| Dimensions are in millimeter |      |      |      |       |      |      |      |      |      |      |
|------------------------------|------|------|------|-------|------|------|------|------|------|------|
| Pkg type                     | A    | B    | C    | d     | E    | F    | P0   | P    | P1   | W    |
| SOT-323                      | 2.25 | 2.55 | 1.19 | Ø1.55 | 1.75 | 3.50 | 4.00 | 4.00 | 2.00 | 8.00 |

## SOT-323 Tape Leader and Trailer

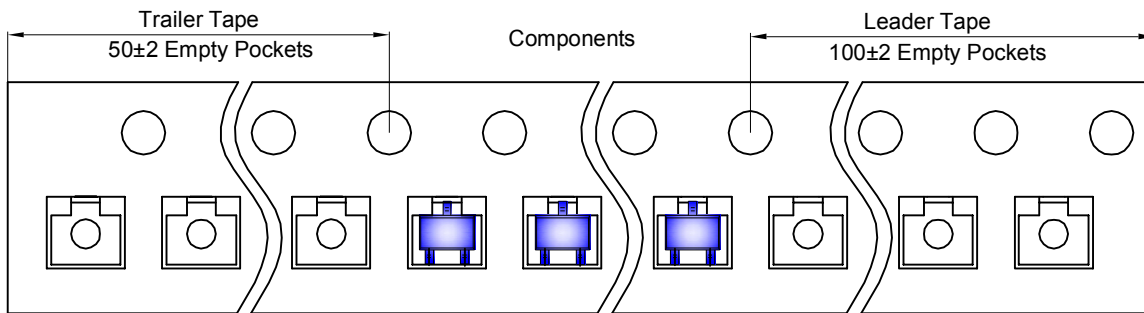

## SOT-323 Reel

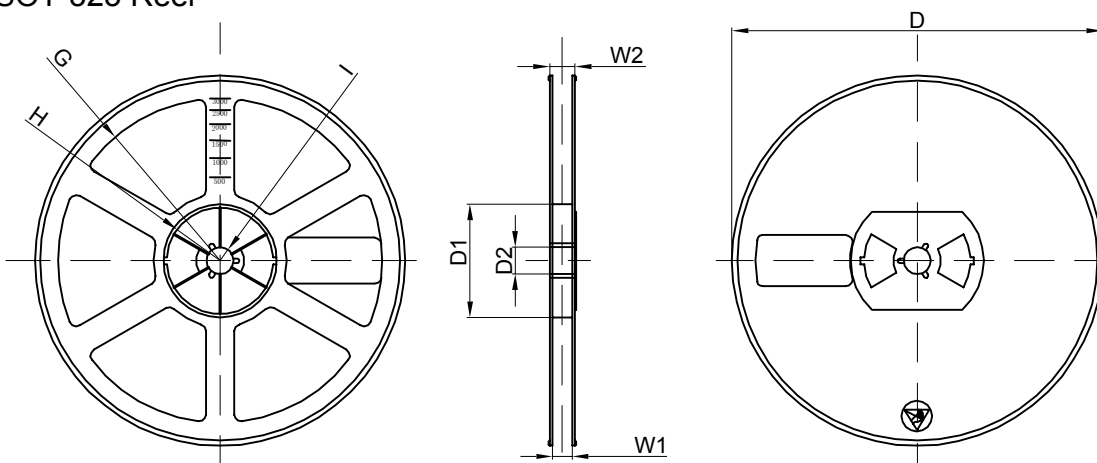

| Dimensions are in millimeter |         |       |       |        |        |       |      |       |
|------------------------------|---------|-------|-------|--------|--------|-------|------|-------|
| Reel Option                  | D       | D1    | D2    | G      | H      | I     | W1   | W2    |
| 7" Dia                       | Ø178.00 | 54.40 | 13.00 | R78.00 | R25.60 | R6.50 | 9.50 | 12.30 |

| REEL     | Reel Size | Box        | Box Size(mm) | Carton      | Carton Size(mm) | G.W.(kg) |
|----------|-----------|------------|--------------|-------------|-----------------|----------|
| 3000 pcs | 7 inch    | 30,000 pcs | 203×203×195  | 120,000 pcs | 438×438×220     |          |

## X-ON Electronics

Largest Supplier of Electrical and Electronic Components

*Click to view similar products for [MOSFET](#) category:*

*Click to view products by [CJ](#) manufacturer:*

Other Similar products are found below :

[614233C](#) [648584F](#) [MCH3443-TL-E](#) [MCH6422-TL-E](#) [FDPF9N50NZ](#) [FW216A-TL-2W](#) [FW231A-TL-E](#) [APT5010JVR](#) [NTNS3A92PZT5G](#)  
[IRF100S201](#) [JANTX2N5237](#) [2SK2464-TL-E](#) [2SK3818-DL-E](#) [FCA20N60\\_F109](#) [FDZ595PZ](#) [STD6600NT4G](#) [FSS804-TL-E](#) [2SJ277-DL-E](#)  
[2SK1691-DL-E](#) [2SK2545\(Q,T\)](#) [D2294UK](#) [405094E](#) [423220D](#) [MCH6646-TL-E](#) [TPCC8103,L1Q\(CM](#) [367-8430-0972-503](#) [VN1206L](#)  
[424134F](#) [026935X](#) [051075F](#) [SBVS138LT1G](#) [614234A](#) [715780A](#) [NTNS3166NZT5G](#) [751625C](#) [873612G](#) [IRF7380TRHR](#)  
[IPS70R2K0CEAKMA1](#) [RJK60S3DPP-E0#T2](#) [RJK60S5DPK-M0#T0](#) [APT5010JVFR](#) [APT12031JFLL](#) [APT12040JVR](#) [DMN3404LQ-7](#)  
[NTE6400](#) [JANTX2N6796U](#) [JANTX2N6784U](#) [JANTXV2N5416U4](#) [SQM110N05-06L-GE3](#) [SIHF35N60E-GE3](#)