

CJL8205A Dual N-Channel MOSFET

$V_{(BR)DSS}$	$R_{DS(on)MAX}$	I_D
20V	30mΩ@4.5V	5A
	45mΩ@2.5V	

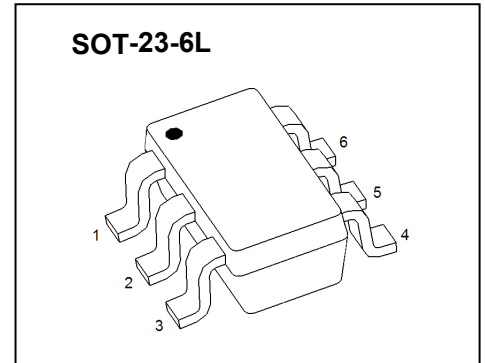

FEATURE

- TrenchFET Power MOSFET
- Excellent $R_{DS(on)}$
- Low Gate Charge
- High Power and Current Handling Capability
- Surface Mount Package

APPLICATION

- Battery Protection
- Load Switch
- Power Management

MARKING

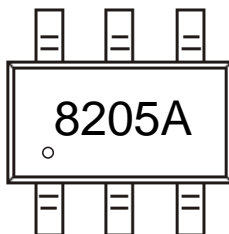

Equivalent Circuit

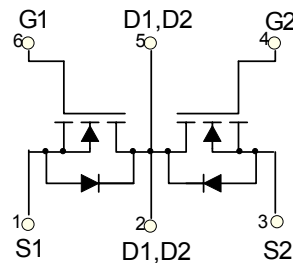

ABSOLUTE MAXIMUM RATINGS ($T_a=25^{\circ}C$ unless otherwise noted)

Parameter	Symbol	Value	Unit
Drain-Source Voltage	V_{DS}	20	V
Gate-Source Voltage	V_{GS}	±10	V
Continuous Drain Current	I_D	6	A
Pulsed Drain Current (note 1)	I_{DM}	25	A
Thermal Resistance from Junction to Ambient (note 2)	$R_{\theta JA}$	357	$^{\circ}C/W$
Junction Temperature	T_J	150	$^{\circ}C$
Storage Temperature	T_{STG}	-55~+150	$^{\circ}C$
Lead Temperature for Soldering Purposes(1/8" from case for 10 s)	T_L	260	$^{\circ}C$

MOSFET ELECTRICAL CHARACTERISTICS

$T_a=25^\circ\text{C}$ unless otherwise specified

Parameter	Symbol	Test Condition	Min	Typ	Max	Unit
STATIC CHARACTERISTICS						
Drain-source breakdown voltage	$V_{(BR)DSS}$	$V_{GS} = 0V, I_D = 250\mu A$	19			V
Zero gate voltage drain current	I_{DSS}	$V_{DS} = 18V, V_{GS} = 0V$			1	μA
Gate-body leakage current	I_{GSS}	$V_{GS} = \pm 10V, V_{DS} = 0V$			± 100	nA
Gate threshold voltage (note 3)	$V_{GS(th)}$	$V_{DS} = V_{GS}, I_D = 250\mu A$	0.6	0.8	1.5	V
Drain-source on-resistance (note 3)	$R_{DS(on)}$	$V_{GS} = 4.5V, I_D = 3A$		23	30	m Ω
		$V_{GS} = 2.5V, I_D = 3A$		30	45	m Ω
Forward transconductance (note 3)	g_{FS}	$V_{DS} = 5V, I_D = 4.5A$		12		S
Diode forward voltage (note 3)	V_{SD}	$I_S = 1.25A, V_{GS} = 0V$			1.2	V
DYNAMIC CHARACTERISTICS (note 4)						
Input Capacitance	C_{iss}	$V_{DS} = 8V, V_{GS} = 0V, f = 1MHz$		815		pF
Output Capacitance	C_{oss}			158		pF
Reverse Transfer Capacitance	C_{rss}			124		pF
SWITCHING CHARACTERISTICS (note 4)						
Turn-on delay time	$t_{d(on)}$	$V_{DD} = 10V, V_{GS} = 4V,$ $I_D = 1A, R_{GEN} = 10\Omega$		16		ns
Turn-on rise time	t_r			8		ns
Turn-off delay time	$t_{d(off)}$			36		ns
Turn-off fall time	t_f			18		ns
Total Gate Charge	Q_g	$V_{DS} = 10V, V_{GS} = 4.5V, I_D = 4A$		14		nC
Gate-Source Charge	Q_{gs}			2.5		nC
Gate-Drain Charge	Q_{gd}			2.5		nC

Notes :

1. Repetitive rating: Pulse width limited by maximum junction temperature
2. Surface Mounted on FR4 board, $t \leq 10$ sec.
3. Pulse test : Pulse width $\leq 300\mu s$, duty cycle $\leq 2\%$.
4. Guaranteed by design, not subject to production.

Typical Characteristics

Output Characteristics

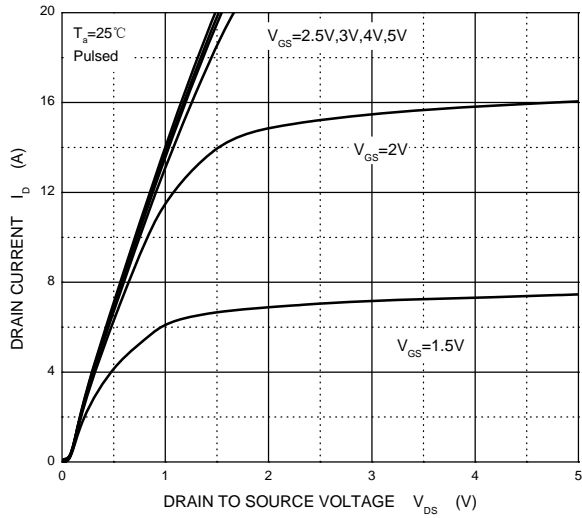

Transfer Characteristics

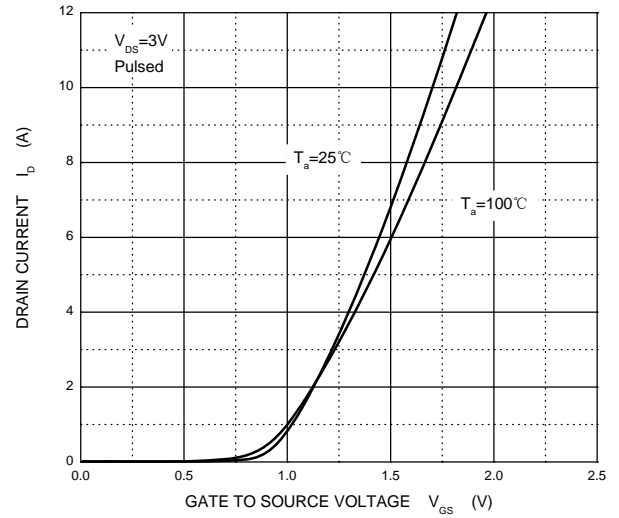

$R_{DS(ON)}$ — I_D

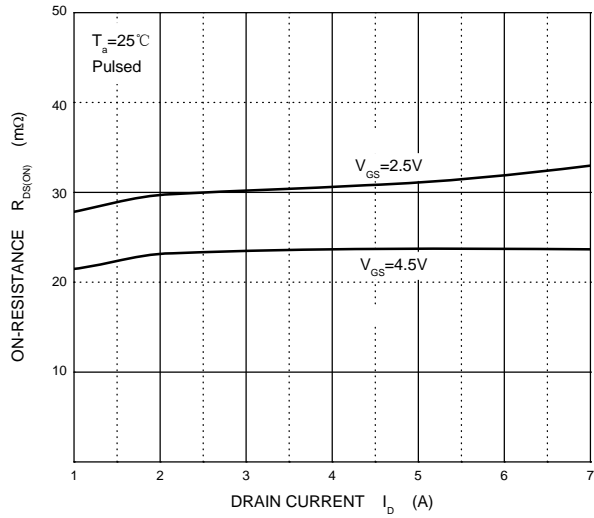

$R_{DS(ON)}$ — V_{GS}

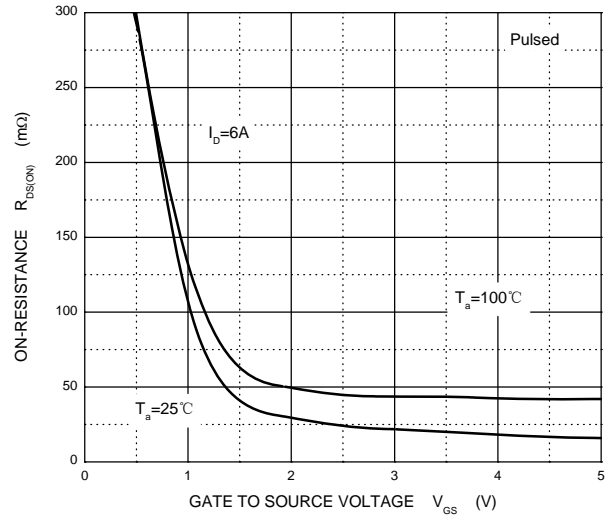

I_S — V_{SD}

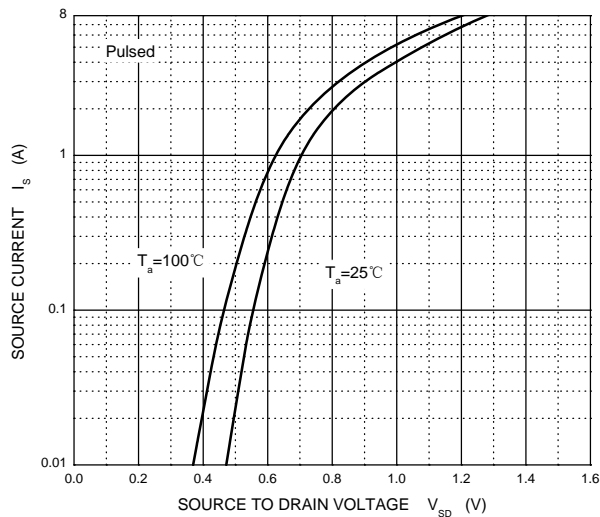

Threshold Voltage

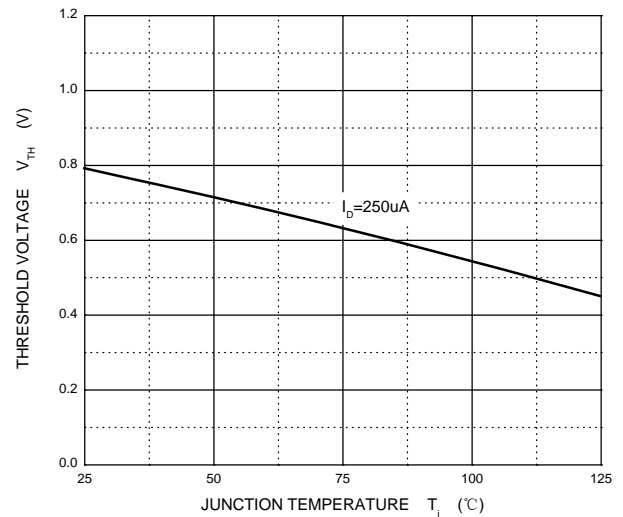

SOT-23-6L Package Outline Dimensions

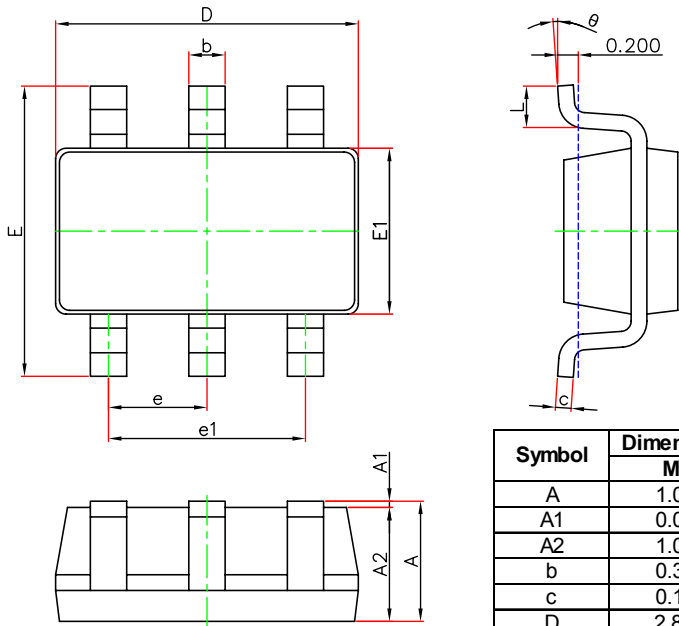

Symbol	Dimensions In Millimeters		Dimensions In Inches	
	Min.	Max.	Min.	Max.
A	1.050	1.250	0.041	0.049
A1	0.000	0.100	0.000	0.004
A2	1.050	1.150	0.041	0.045
b	0.300	0.500	0.012	0.020
c	0.100	0.200	0.004	0.008
D	2.820	3.020	0.111	0.119
E1	1.500	1.700	0.059	0.067
E	2.650	2.950	0.104	0.116
e	0.950(BSC)		0.037(BSC)	
e1	1.800	2.000	0.071	0.079
L	0.300	0.600	0.012	0.024
θ	0°	8°	0°	8°

SOT-23-6L Suggested Pad Layout

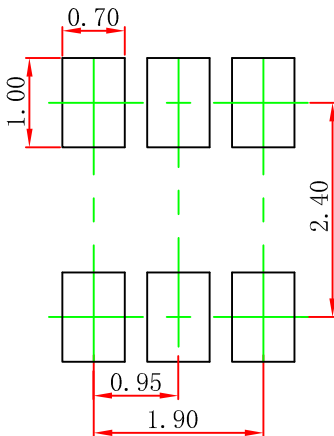

- Note:
1. Controlling dimension: in millimeters.
 2. General tolerance: ± 0.05 mm.
 3. The pad layout is for reference purposes only.

NOTICE

JSCJ reserves the right to make modifications, enhancements, improvements, corrections or other changes without further notice to any product herein. JSCJ does not assume any liability arising out of the application or use of any product described herein.

SOT-23-6L Tape and Reel

SOT-23-6L Embossed Carrier Tape

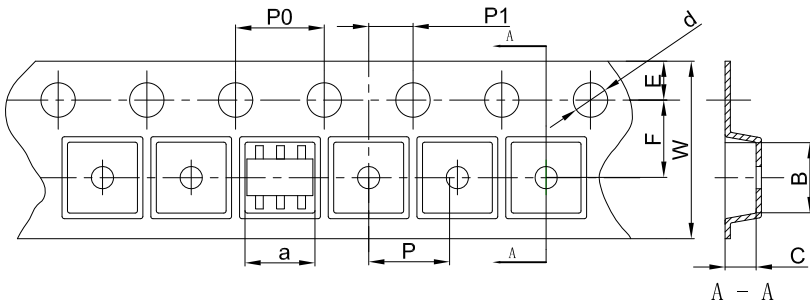

Packaging Description:

SOT-23-6L parts are shipped in tape. The carrier tape is made from a dissipative (carbon filled) polycarbonate resin. The cover tape is a multilayer film (Heat Activated Adhesive in nature) primarily composed of polyester film, adhesive layer, sealant, and anti-static sprayed agent. These reeled parts in standard option are shipped with 3,000 units per 7" or 18.0cm diameter reel. The reels are clear in color and is made of polystyrene plastic (anti-static coated).

Dimensions are in millimeter										
Pkg type	a	B	C	d	E	F	P0	P	P1	W
SOT-23-6L	3.17	3.23	1.37	Ø1.55	1.75	3.50	4.00	4.00	2.00	8.00

SOT-23-6L Tape Leader and Trailer

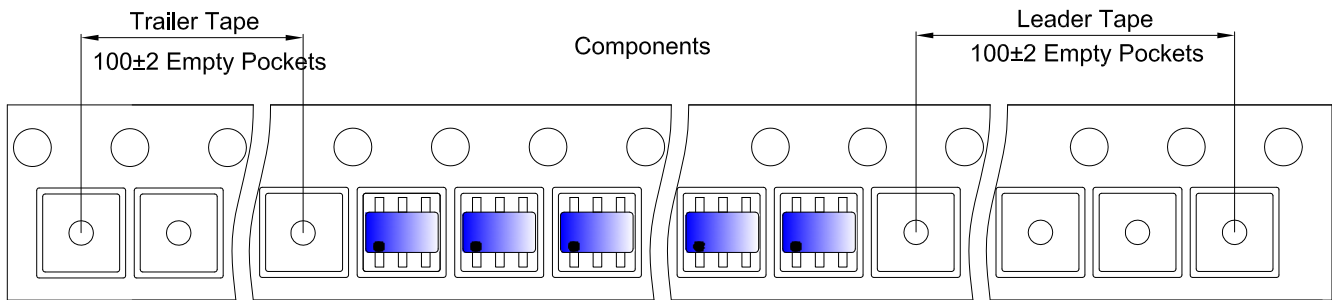

SOT-23-6L Reel

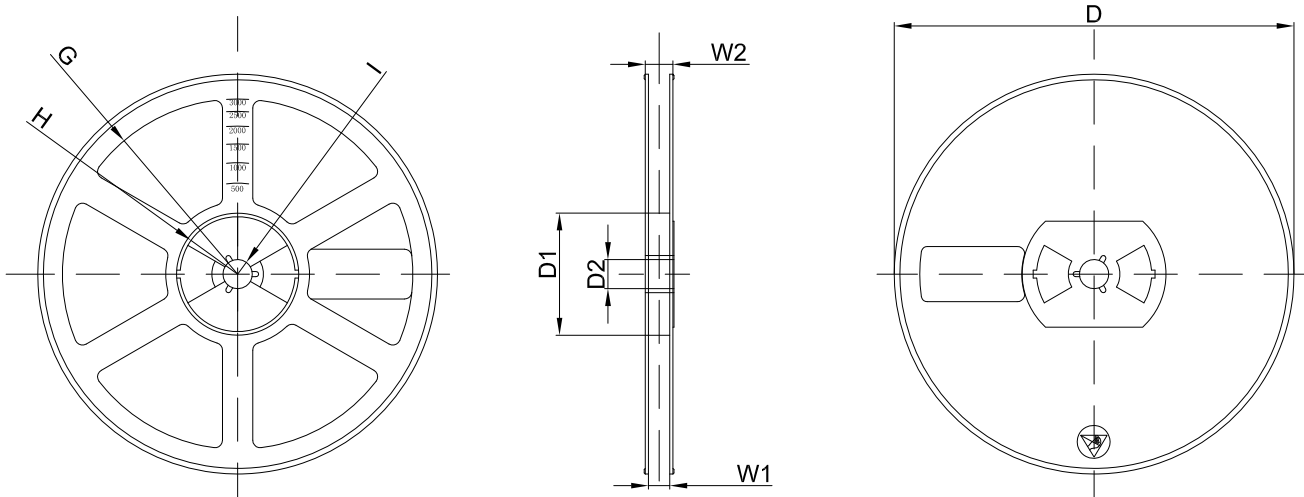

Dimensions are in millimeter								
Reel Option	D	D1	D2	G	H	I	W1	W2
7"Dia	Ø180.00	60.00	13.00	R78.00	R25.60	R6.50	9.50	13.10

REEL	Reel Size	Box	Box Size(mm)	Carton	Carton Size(mm)	G.W.(kg)
3000 pcs	7 inch	30,000 pcs	203×203×195	120,000 pcs	438×438×220	

X-ON Electronics

Largest Supplier of Electrical and Electronic Components

Click to view similar products for [MOSFET](#) category:

Click to view products by [CJ](#) manufacturer:

Other Similar products are found below :

[614233C](#) [648584F](#) [MCH3443-TL-E](#) [MCH6422-TL-E](#) [FDPF9N50NZ](#) [FW216A-TL-2W](#) [FW231A-TL-E](#) [APT5010JVR](#) [NTNS3A92PZT5G](#)
[IRF100S201](#) [JANTX2N5237](#) [2SK2464-TL-E](#) [2SK3818-DL-E](#) [FCA20N60_F109](#) [FDZ595PZ](#) [STD6600NT4G](#) [FSS804-TL-E](#) [2SJ277-DL-E](#)
[2SK1691-DL-E](#) [2SK2545\(Q,T\)](#) [D2294UK](#) [405094E](#) [423220D](#) [MCH6646-TL-E](#) [TPCC8103,L1Q\(CM](#) [367-8430-0972-503](#) [VN1206L](#)
[424134F](#) [026935X](#) [051075F](#) [SBVS138LT1G](#) [614234A](#) [715780A](#) [NTNS3166NZT5G](#) [751625C](#) [873612G](#) [IRF7380TRHR](#)
[IPS70R2K0CEAKMA1](#) [RJK60S3DPP-E0#T2](#) [RJK60S5DPK-M0#T0](#) [APT5010JVFR](#) [APT12031JFLL](#) [APT12040JVR](#) [DMN3404LQ-7](#)
[NTE6400](#) [JANTX2N6796U](#) [JANTX2N6784U](#) [JANTXV2N5416U4](#) [SQM110N05-06L-GE3](#) [SIHF35N60E-GE3](#)