

SOP8 Plastic-Encapsulate MOSFETS

CJQ4606

N-and P-Channel Enhancement Mode Power MOSFET

$V_{(BR)DSS}$	$R_{DS(on)TYP}$	I_D
30V	19mΩ@10V	6.9A
	28mΩ@4.5V	
-30V	29mΩ@-10V	-6.0A
	47mΩ@-4.5V	

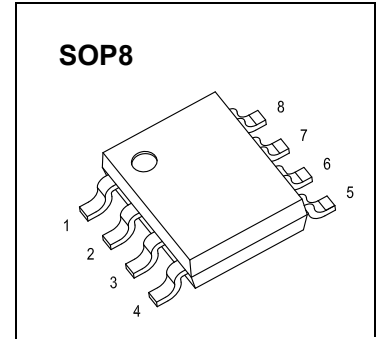

DESCRIPTION

Advance Power MOSFETs provide the designer with the best combination of fast switching, ruggedized device design, low on-resistance and cost-effectiveness.

The SOP8 package is widely preferred for commercial-industrial surface mount applications and suited for low voltage applications such as DC/DC converters.

MARKING:

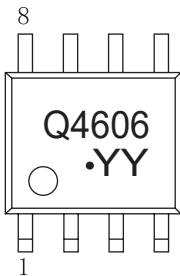

Q4606= Device code
 YY=Date Code
 Solid dot = Pin1 indicator
 Solid dot = Green molding compound device,
 if none,the normal device.

Equivalent Circuit

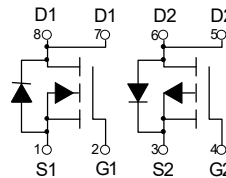

Maximum ratings ($T_a=25^{\circ}C$ unless otherwise noted)

Parameter Sy	mbol	N-Channel	P-Channel	Unit
Drain-Source Voltage	V_{DS}	30	-30	V
Gate-Source Voltage	V_{GS}	±20	±20	
Continuous Drain Current ^a	I_D	$T_a=25^{\circ}C$	6.9	A
		$T_a=70^{\circ}C$	5.5	
Pulsed Drain Current ^b	I_{DM}	20	-20	
Power Dissipation	P_D	1.4		W
Thermal Resistance from Junction to Ambient	$R_{\theta JA}$	89		$^{\circ}C/W$
Operating Junction Temperature	T_J	150		$^{\circ}C$
Storage Temperature	T_{STG}	-55 ~+150		

Notes :

- a. These tests are performed with infinite heat sink.
- b.Pulse width by Max.junction temperature.

MOSFET ELECTRICAL CHARACTERISTICS

$T_a = 25^\circ\text{C}$ unless otherwise specified

Parameter	Symbol	Test Condition	Min	Typ	Max	Units	
Static							
Drain-source breakdown voltage	$V_{(BR)DSS}$	$V_{GS}=0, I_D = 250\mu\text{A}$	N-Ch	30		V	
		$V_{GS}=0, I_D = -250\mu\text{A}$	P-Ch	-30			
Gate-threshold voltage	$V_{GS(th)}$	$V_{DS} = V_{GS}, I_D = 250\mu\text{A}$	N-Ch	1	1.5	3	V
		$V_{DS} = V_{GS}, I_D = -250\mu\text{A}$	P-Ch	-1	-1.7	-3	
Gate-body leakage	I_{GSS}	$V_{DS} = 0\text{V}, V_{GS} = \pm 20\text{V}$	N-Ch			± 100	nA
			P-Ch				
Zero gate voltage drain current	I_{DSS}	$V_{DS} = 30\text{V}, V_{GS} = 0\text{V}$	N-Ch			1	μA
		$V_{DS} = -30\text{V}, V_{GS} = 0\text{V}$	P-Ch			-1	
Drain-source on-resistance ^c	$R_{DS(on)}$	$V_{GS} = 10\text{V}, I_D = 6\text{A}$	N-Ch		19	28	m Ω
		$V_{GS} = -10\text{V}, I_D = -6\text{A}$	P-Ch		29	36	
		$V_{GS} = 4.5\text{V}, I_D = 4\text{A}$	N-Ch		28	42	
		$V_{GS} = -4.5\text{V}, I_D = -4\text{A}$	P-Ch		47	55	
Forward transconductance	g_{fs}	$V_{DS} = 10\text{V}, I_D = 6\text{A}$	N-Ch	4			S
		$V_{DS} = -10\text{V}, I_D = -6\text{A}$	P-Ch				
Diode forward voltage ^c	V_{SD}	$I_S = 1.7\text{A}, V_{GS} = 0\text{V}$	N-Ch			1.2	V
		$I_S = -1.7\text{A}, V_{GS} = 0\text{V}$	P-Ch			-1.2	
Dynamic							
Total gate charge ^c	Q_g	N-Channel	N-Ch		9.5		nC
			P-Ch		9.5		
Gate-source charge ^d	Q_{gs}	$V_{DS} = 15\text{V}, V_{GS} = 4.5\text{V}, I_D = 6\text{A}$	N-Ch		1.5		nC
			P-Ch		2		
Gate-drain charge ^d	Q_{gd}	$V_{DS} = -15\text{V}, V_{GS} = -4.5\text{V}, I_D = -6\text{A}$	N-Ch		3		nC
			P-Ch		3		
Turn-on delay time ^c	$t_{d(on)}$	N-Channel	N-Ch		3.3		ns
			P-Ch		7		
Rise time ^d	t_r	$V_{DS} = 15\text{V}, R_L = 2.2\Omega,$ $V_{GS} = 10\text{V}, R_G = 3\Omega$	N-Ch		4.8		ns
			P-Ch		3		
Turn-off delay time ^d	$t_{d(off)}$	P-Channel	N-Ch		26		ns
			P-Ch		20		
Fall time ^d	t_f	$V_{GS} = -10\text{V}, R_G = 3\Omega$	N-Ch		4		ns
			P-Ch		12		
Input Capacitance ^d	C_{iss}	N-Channel	N-Ch		633		pF
			P-Ch		850		
Output Capacitance ^d	C_{oss}	$V_{DS} = 15\text{V}, V_{GS} = 0\text{V}, f = 1\text{MHz}$	N-Ch		65		pF
			P-Ch		101		
Reverse Transfer Capacitance ^d	C_{rss}	$V_{DS} = -15\text{V}, V_{GS} = 0\text{V}, f = 1\text{MHz}$	N-Ch		55		pF
			P-Ch		65		

Notes :

- c. Pulse Test : Pulse width $\leq 300\mu\text{s}$, duty cycle $\leq 2\%$.
- d. Guaranteed by design, not subject to production testing.

Typical Characteristics

CJQ4606-N-Ch

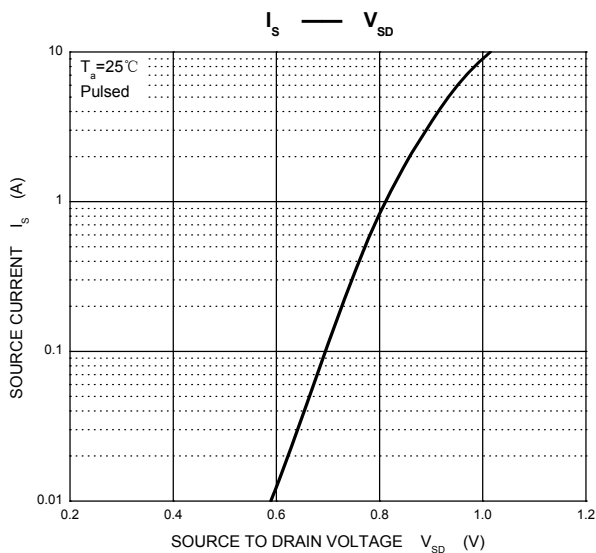
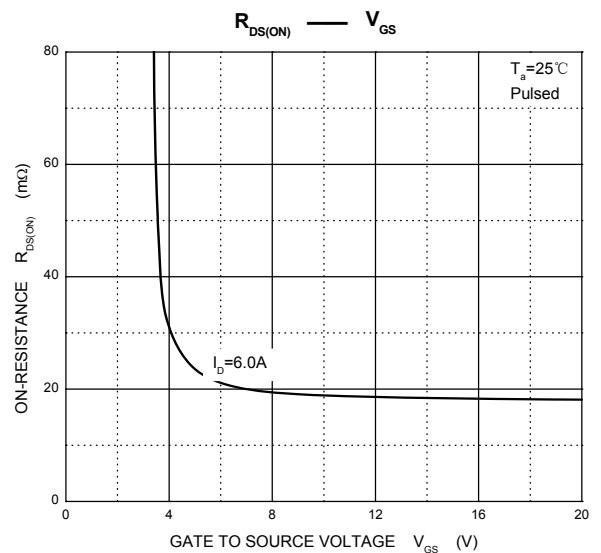
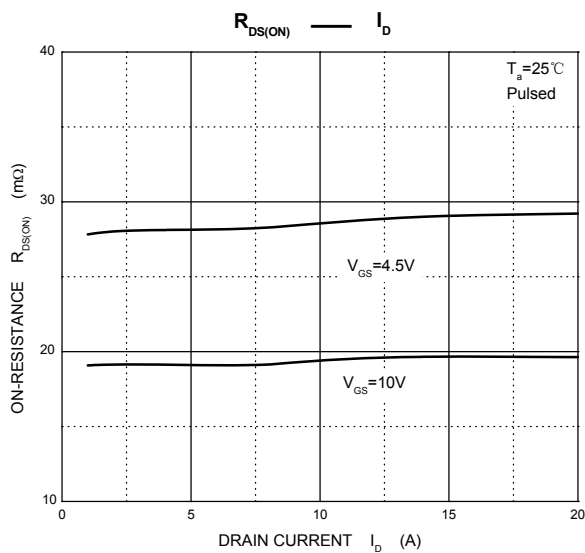
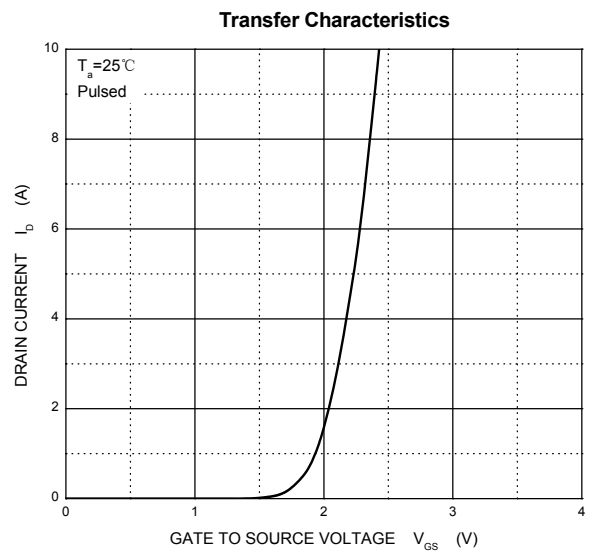
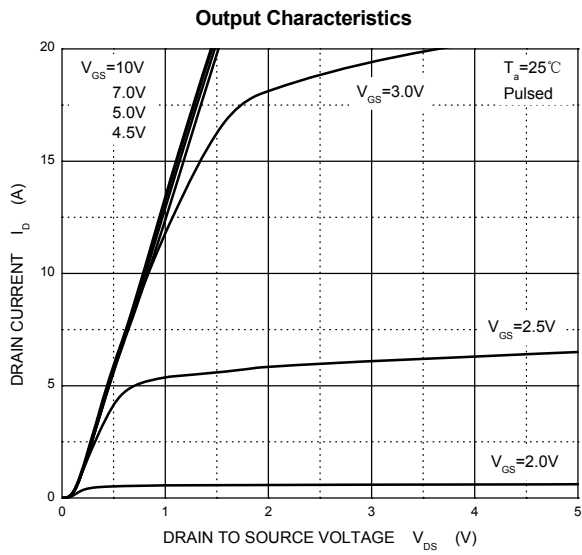

Typical Characteristics

CJQ4606-P-Ch

Output Characteristics

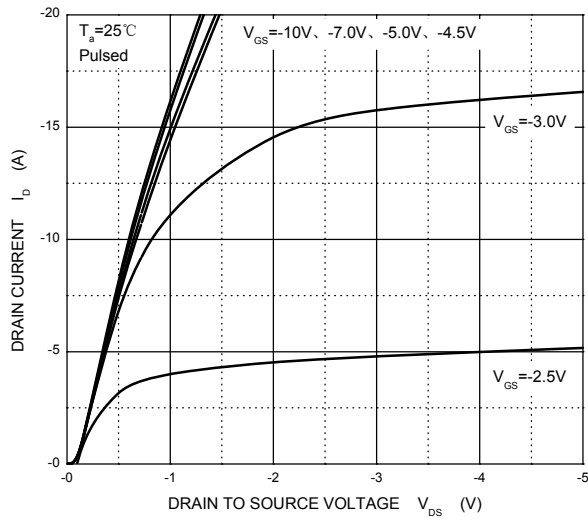

Transfer Characteristics

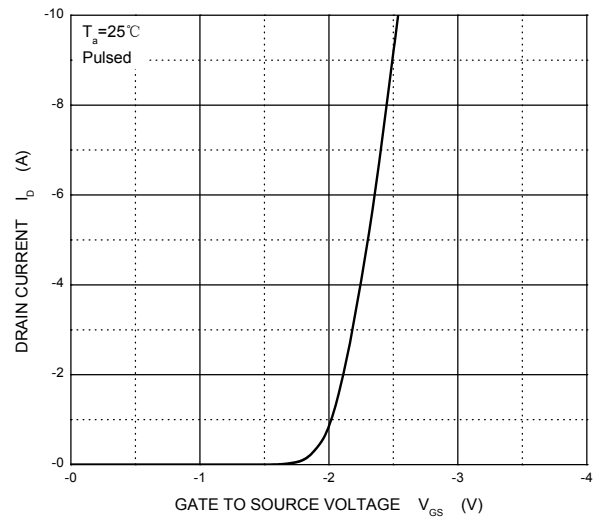

$R_{DS(ON)}$ — I_D

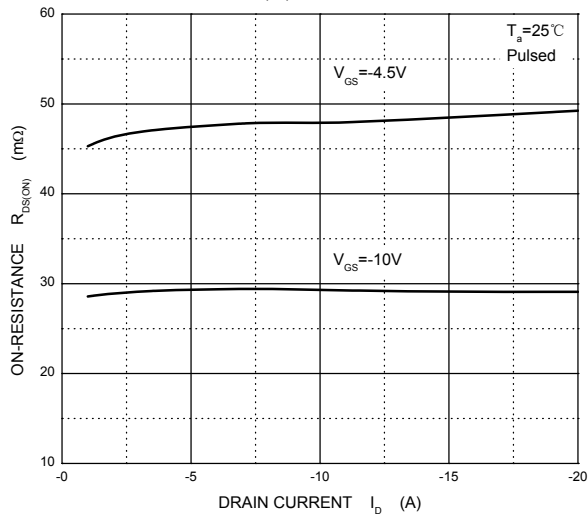

$R_{DS(ON)}$ — V_{GS}

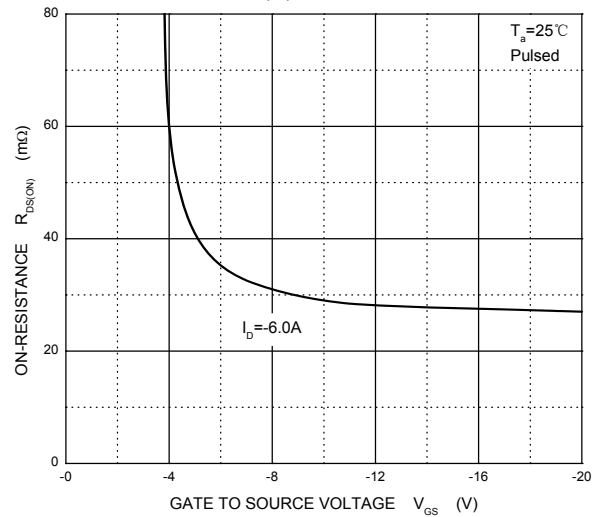

I_S — V_{SD}

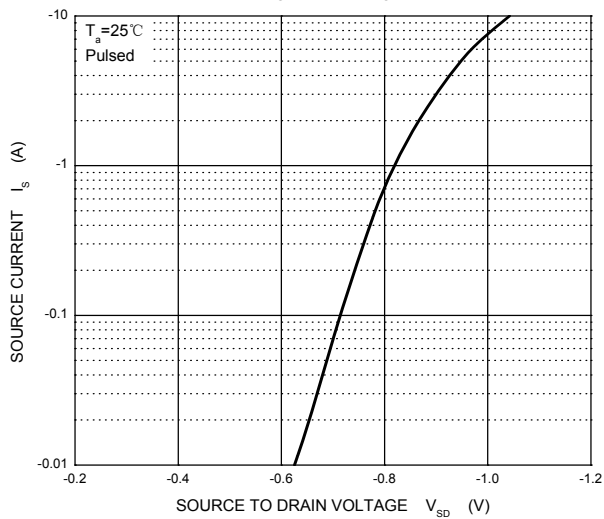

SOP8 Package Outline Dimensions

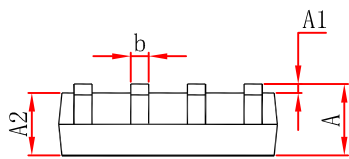
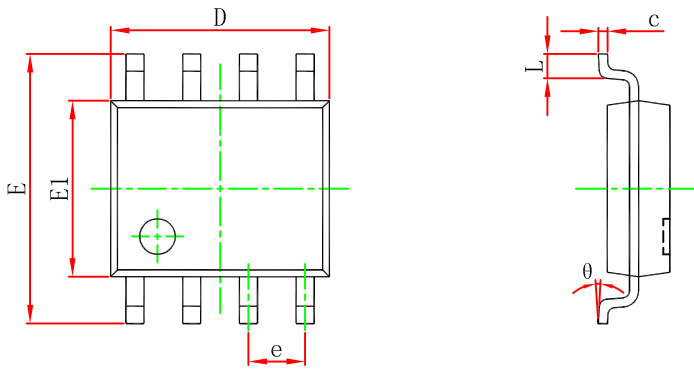

Symbol	Dimensions In Millimeters		Dimensions In Inches	
	Min	Max	Min	Max
A	1.350	1.750	0.053	0.069
A1	0.100	0.250	0.004	0.010
A2	1.350	1.550	0.053	0.061
b	0.330	0.510	0.013	0.020
c	0.170	0.250	0.007	0.010
D	4.800	5.000	0.189	0.197
e	1.270 (BSC)		0.050 (BSC)	
E	5.800	6.200	0.228	0.244
E1	3.800	4.000	0.150	0.157
L	0.400	1.270	0.016	0.050
θ	0°	8°	0°	8°

SOP8 Suggested Pad Layout

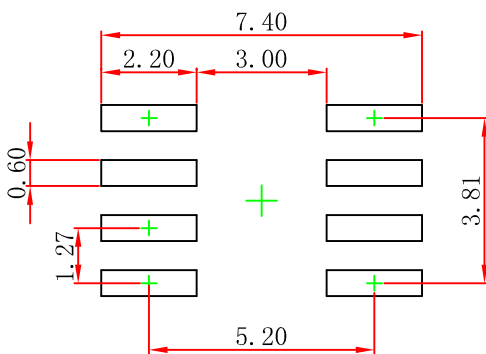

Note:

1. Controlling dimension: in millimeters.
2. General tolerance: $\pm 0.05\text{mm}$.
3. The pad layout is for reference purposes only.

NOTICE

JSCJ reserves the right to make modifications, enhancements, improvements, corrections or other changes without further notice to any product herein. JSCJ does not assume any liability arising out of the application or use of any product described herein.

SOP8 Tape and Reel

SOP8 Embossed Carrier Tape

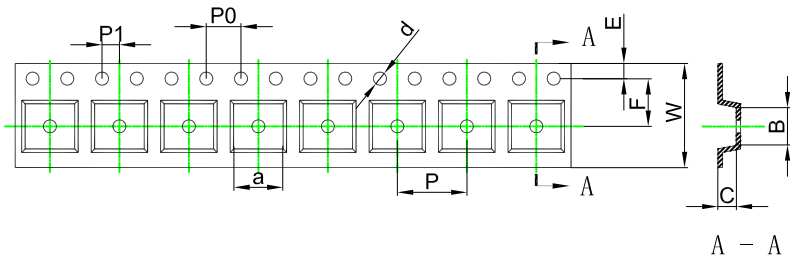

Packaging Description:

SOP8 parts are shipped in tape. The carrier tape is made from a dissipative (carbon filled) polycarbonate resin. The cover tape is a multilayer film (Heat Activated Adhesive in nature) primarily composed of polyester film, adhesive layer, sealant, and anti-static sprayed agent. These reeled parts in standard option are shipped with 2,500 units per 13" or 33cm diameter reel. The reels are clear in color and is made of polystyrene plastic (anti-static coated).

ALL DIM IN mm

Dimensions are in millimeter										
Pkg type	a	B	C	d	E	F	P0	P	P1	W
SOP8	6.40	5.40	2.10	Ø1.50	1.75	5.50	4.00	8.00	2.00	12.00

SOP8 Tape Leader and Trailer

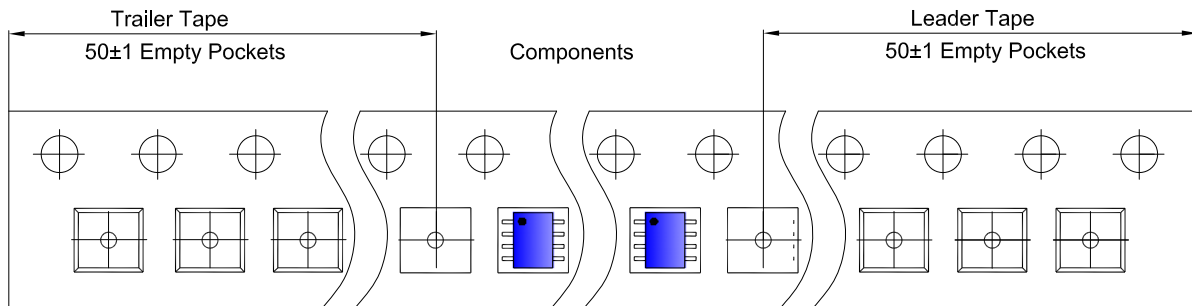

SOP8 Reel

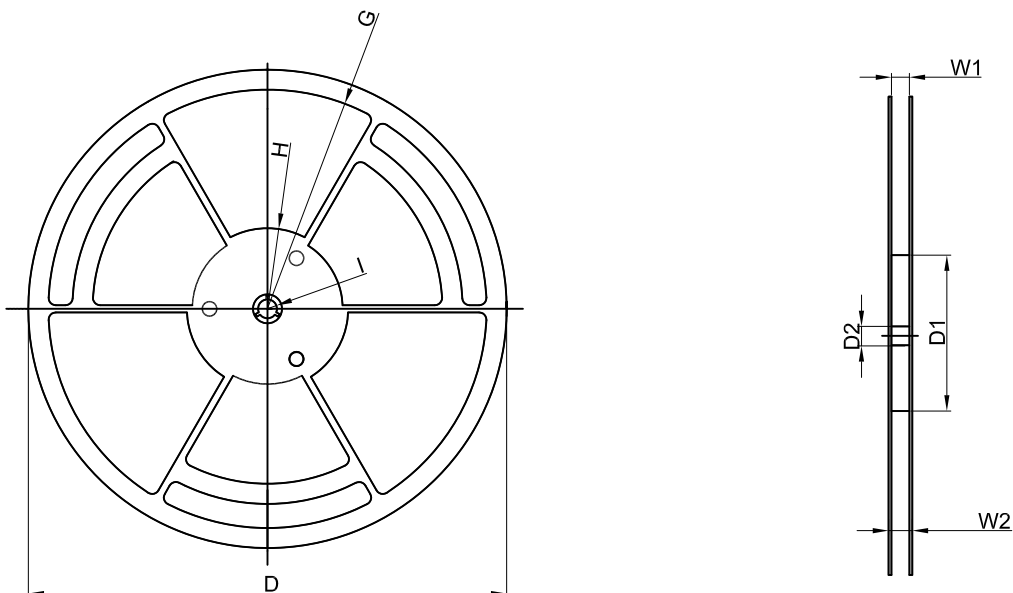

Dimensions are in millimeter								
Reel Option	D	D1	D2	G	H	I	W1	W2
13" Dia	Ø330.00	100.00	13.00	R151.00	R56.00	R6.50	12.40	17.60

REEL	Reel Size	Box	Box Size(mm)	Carton	Carton Size(mm)	G.W.(kg)
4,000 pcs	13 inch	8,000 pcs	360×360×65	64,000 pcs	565×380×390	

X-ON Electronics

Largest Supplier of Electrical and Electronic Components

Click to view similar products for [MOSFET](#) category:

Click to view products by [CJ](#) manufacturer:

Other Similar products are found below :

[614233C](#) [648584F](#) [MCH3443-TL-E](#) [MCH6422-TL-E](#) [FDPF9N50NZ](#) [FW216A-TL-2W](#) [FW231A-TL-E](#) [APT5010JVR](#) [NTNS3A92PZT5G](#)
[IRF100S201](#) [JANTX2N5237](#) [2SK2464-TL-E](#) [2SK3818-DL-E](#) [FCA20N60_F109](#) [FDZ595PZ](#) [STD6600NT4G](#) [FSS804-TL-E](#) [2SJ277-DL-E](#)
[2SK1691-DL-E](#) [2SK2545\(Q,T\)](#) [D2294UK](#) [405094E](#) [423220D](#) [MCH6646-TL-E](#) [TPCC8103,L1Q\(CM](#) [367-8430-0972-503](#) [VN1206L](#)
[424134F](#) [026935X](#) [051075F](#) [SBVS138LT1G](#) [614234A](#) [715780A](#) [NTNS3166NZT5G](#) [751625C](#) [873612G](#) [IRF7380TRHR](#)
[IPS70R2K0CEAKMA1](#) [RJK60S3DPP-E0#T2](#) [RJK60S5DPK-M0#T0](#) [APT5010JVFR](#) [APT12031JFLL](#) [APT12040JVR](#) [DMN3404LQ-7](#)
[NTE6400](#) [JANTX2N6796U](#) [JANTX2N6784U](#) [JANTXV2N5416U4](#) [SQM110N05-06L-GE3](#) [SIHF35N60E-GE3](#)