

SOP8 Plastic-Encapsulate MOSFETS

CJQ6601 P-channel and N-channel Complementary MOSFETS

DESCRIPTIONS

The Device uses advanced trench technology to provide excellent $R_{DS(ON)}$ and low gate charge. The complementary MOSFETs form a high-speed power inverter, suitable for a multitude of applications.

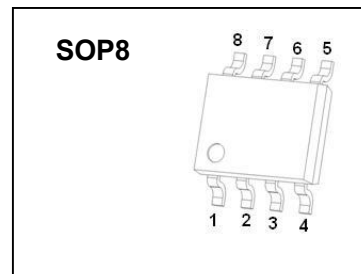

FEATURES

- Including a N-ch CJ3400 MOS and a P-ch CJ3401 MOS (independently) in a package
- Surface mount package
- Low $R_{DS(on)}$

APPLICATIONS

- Suitable for a multitude of applications.
- High-speed power inverter

MARKING:

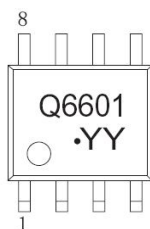

Q6601= Device code
 Solid dot=Pin1 indicator
 Solid dot = Green molding compound device,
 if none, the normal device
 YY=Date Code

EQUIVALENT CIRCUIT

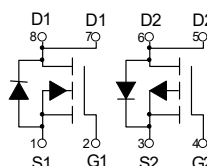

MAXIMUM RATINGS ($T_a=25^\circ\text{C}$ unless otherwise noted)

Symbol	Parameter	Value		Unit
		N-ch MOS	P-ch MOS	
V_{DS}	Drain-Source Voltage	30	-30	V
V_{GS}	Gate-Source Voltage	± 12	± 12	V
I_D	Drain Current -Continuous(Note1)	5.8	-4.2	A
I_{DM}	Drain Current - Pulse(Note3)	23.2	-16.8	A
Power Dissipation, Temperature and Thermal Resistance				
P_D	Power Dissipation		1.4	W
$R_{\theta JA}$	Thermal Resistance from Junction to Ambient		89	$^\circ\text{C/W}$
T_j	Junction Temperature		150	$^\circ\text{C}$
T_{stg}	Storage Temperature		-55~+150	$^\circ\text{C}$
T_L	Lead Temperature		260	$^\circ\text{C}$

N-channel MOSFET ELECTRICAL CHARACTERISTICS (T_a=25°C unless otherwise specified)

Parameter	Symbol	Test conditions	Min	Typ	Max	Unit
STATIC PARAMETERS						
Drain-source breakdown voltage	V _{(BR)DSS}	V _{GS} = 0V, I _D = 250μA	30			V
Zero gate voltage drain current	I _{DSS}	V _{DS} = 24V, V _{GS} = 0V			1	μA
Gate-body leakage current	I _{GSS}	V _{GS} = ±12V, V _{DS} = 0V			±100	nA
Gate threshold voltage (note 1)	V _{GS(th)}	V _{DS} = V _{GS} , I _D = 250μA	0.7		1.4	V
Drain-source on-resistance(note 1)	R _{DS(on)}	V _{GS} = 10V, I _D = 5.8A		19	35	mΩ
		V _{GS} = 4.5V, I _D = 5A		21	40	mΩ
		V _{GS} = 2.5V, I _D = 4A		26	52	mΩ
Forward transconductance(note 1)	g _{FS}	V _{DS} = 5V, I _D = 5A	8			S
Diode forward voltage(note 1)	V _{SD}	I _S = 1A, V _{GS} = 0V			1	V
DYNAMIC PARAMETERS (note 2)						
Input Capacitance	C _{iss}	V _{DS} = 15V, V _{GS} = 0V, f = 1MHz			1050	pF
Output Capacitance	C _{oss}			99		pF
Reverse Transfer Capacitance	C _{rss}			77		pF
SWITCHING PARAMETERS (note 2)						
Turn-on delay time	t _{d(on)}	V _{GS} = 10V, V _{DS} = 15V, R _L = 2.7Ω, R _{GEN} = 3Ω, I _D = 0.5A			5	ns
Turn-on rise time	t _r				7	ns
Turn-off delay time	t _{d(off)}				40	ns
Turn-off fall time	t _f				6	ns

P-channel MOSFET ELECTRICAL CHARACTERISTICS (T_a=25°C unless otherwise specified)

STATIC PARAMETERS						
Drain-source breakdown voltage	V _{(BR)DSS}	V _{GS} = 0V, I _D = -250μA	-30			V
Zero gate voltage drain current	I _{DSS}	V _{DS} = -24V, V _{GS} = 0V			-1	μA
Gate-body leakage current	I _{GSS}	V _{GS} = ±12V, V _{DS} = 0V			±100	nA
Gate threshold voltage (note 1)	V _{GS(th)}	V _{DS} = V _{GS} , I _D = -250μA	-0.7		-1.3	V
Drain-source on-resistance (note 1)	R _{DS(on)}	V _{GS} = -10V, I _D = -4.2A			65	mΩ
		V _{GS} = -4.5V, I _D = -4A			75	mΩ
		V _{GS} = -2.5V, I _D = -1A			90	mΩ
Forward transconductance (note 1)	g _{FS}	V _{DS} = -5V, I _D = -5A	7			S
Diode forward voltage(note 1)	V _{SD}	I _S = -1A, V _{GS} = 0V			-1	V
DYNAMIC PARAMETERS (note 2)						
Input Capacitance	C _{iss}	V _{DS} = -15V, V _{GS} = 0V, f = 1MHz		954		pF
Output Capacitance	C _{oss}			115		pF
Reverse Transfer Capacitance	C _{rss}			77		pF
SWITCHING PARAMETERS (note 2)						
Turn-on delay time	t _{d(on)}	V _{GS} = -10V, V _{DS} = -15V, R _L = 3.6Ω, R _{GEN} = 6Ω, I _D = 0.5A			6.3	ns
Turn-on rise time	t _r				3.2	ns
Turn-off delay time	t _{d(off)}				38.2	ns
Turn-off fall time	t _f				12	ns

Note:

- 1、 Pulse test: pulse width = 300μs, duty cycle ≤ 2%
- 2、 These parameters have no way to verify.

N-channel MOSFET ELECTRICAL CHARACTERISTICS

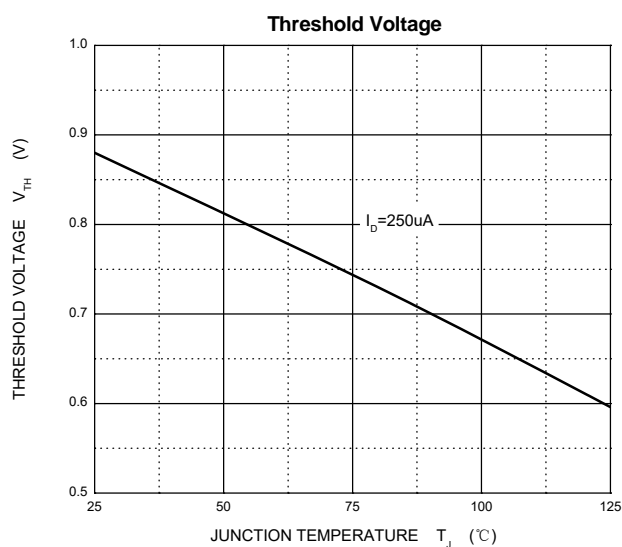
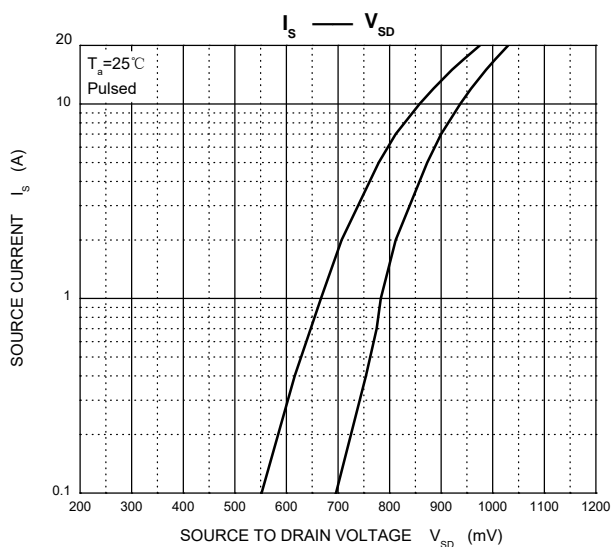
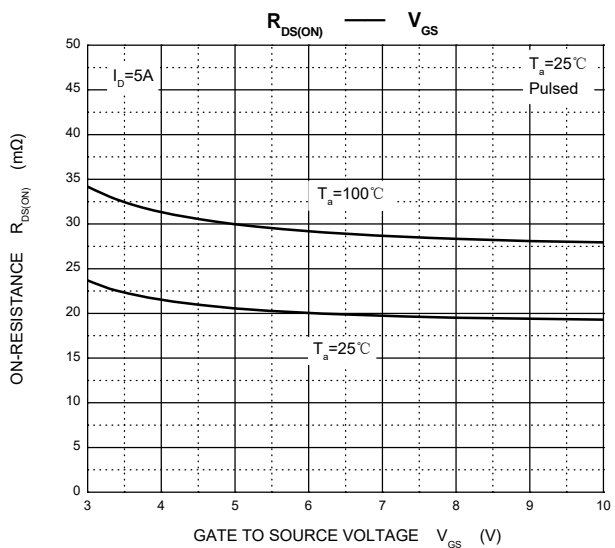
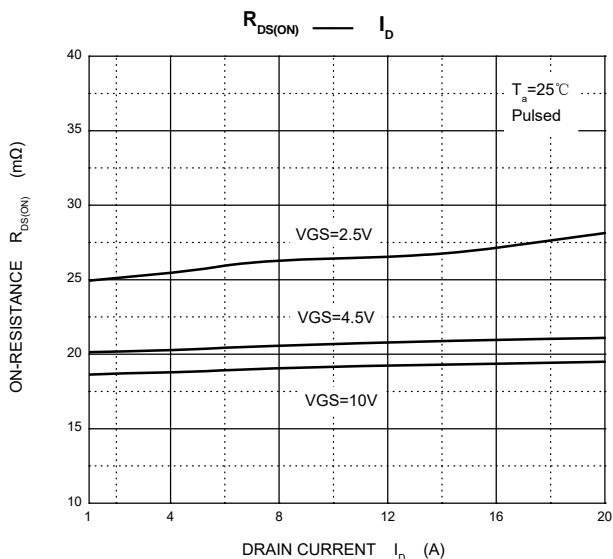
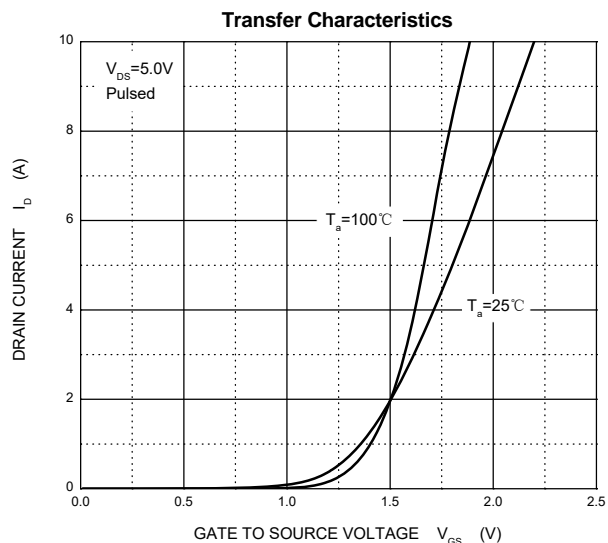
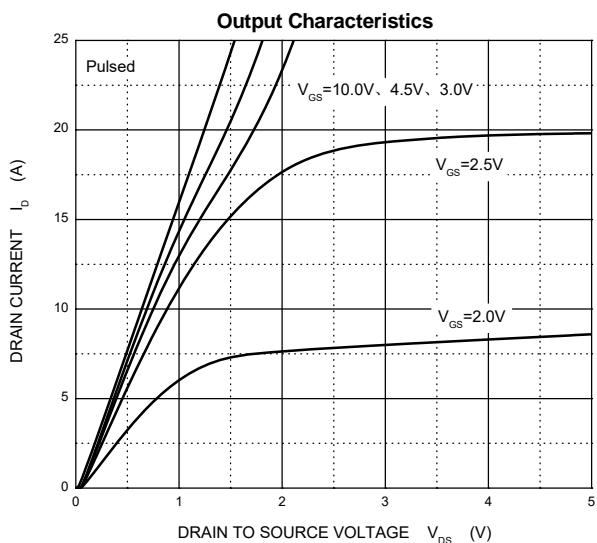

P-channel MOSFET ELECTRICAL CHARACTERISTICS

Output Characteristics

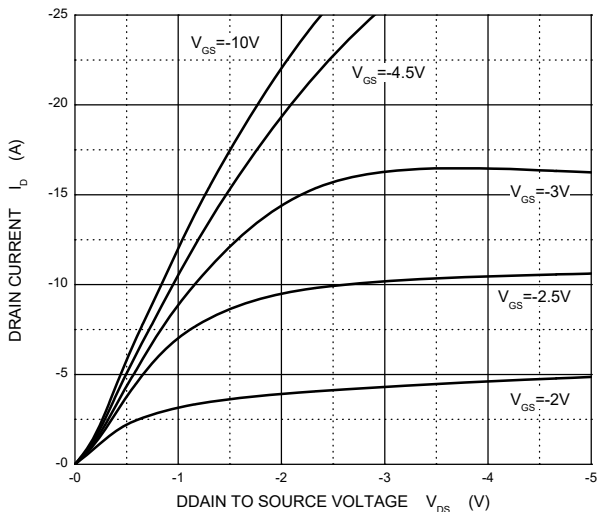

Transfer Characteristics

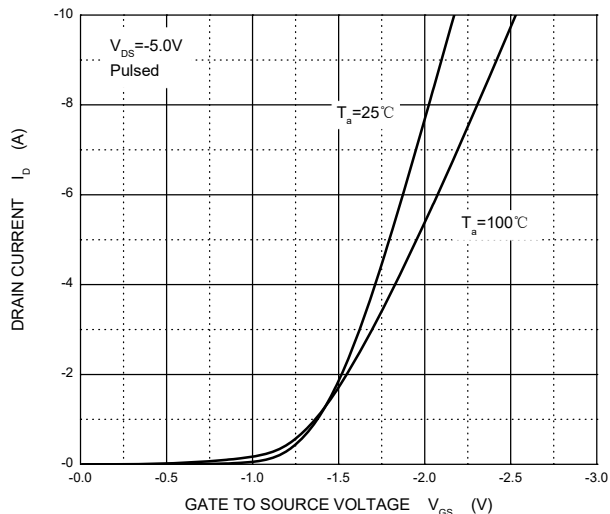

$R_{DS(ON)}$ — I_D

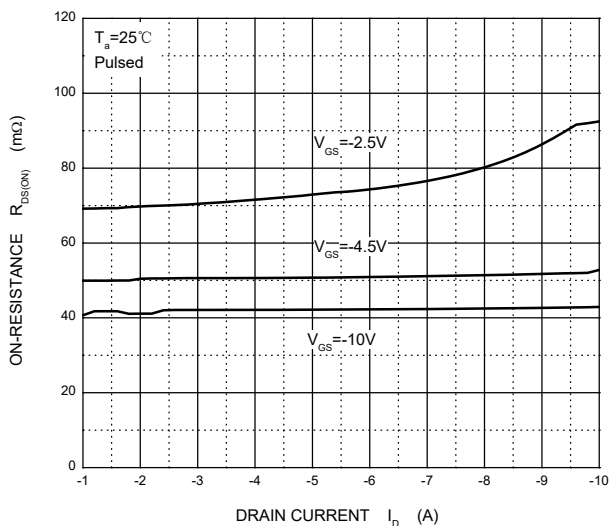

$R_{DS(ON)}$ — V_{GS}

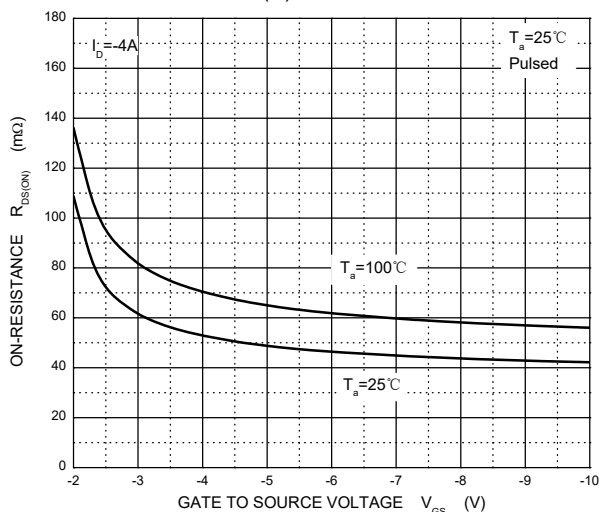

I_S — V_{SD}

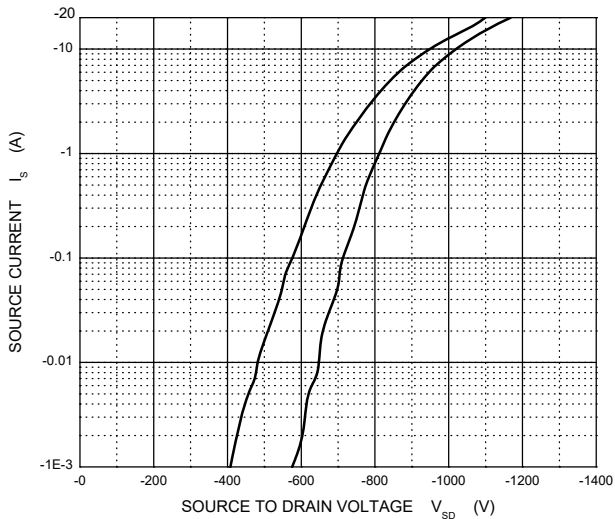

Threshold Voltage

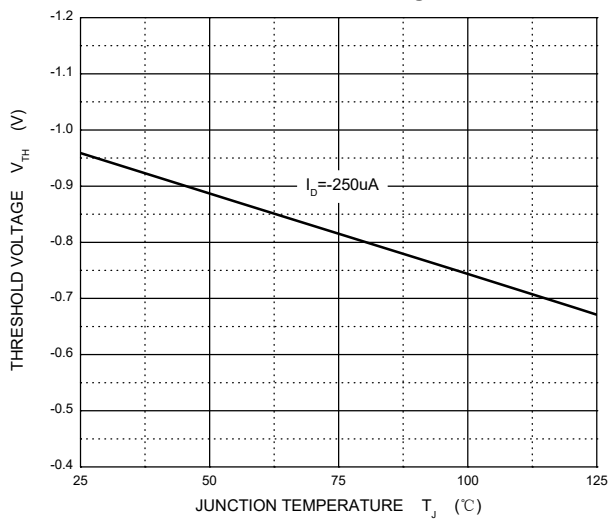

SOP8 Package Outline Dimensions

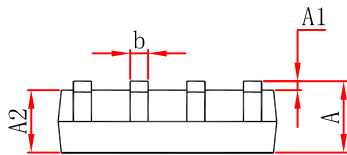
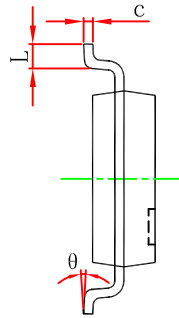
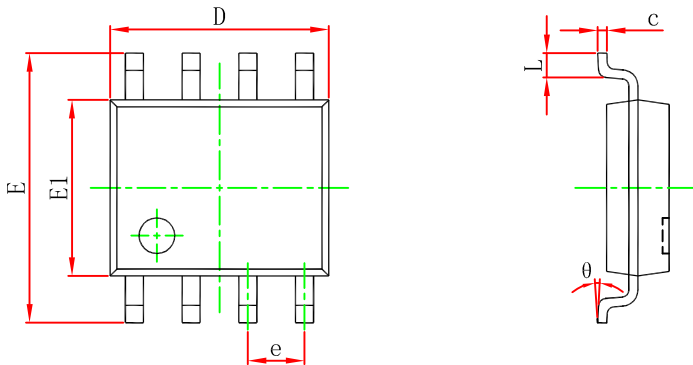

Symbol	Dimensions In Millimeters		Dimensions In Inches	
	Min	Max	Min	Max
A	---	1.750	---	0.069
A1	0.100	0.250	0.004	0.010
A2	1.250	1.500	0.049	0.059
b	0.330	0.510	0.013	0.020
c	0.170	0.250	0.007	0.010
D	4.800	5.000	0.189	0.197
e	1.270 (BSC)		0.050 (BSC)	
E	5.800	6.200	0.228	0.244
E1	3.800	4.000	0.150	0.157
L	0.400	1.270	0.016	0.050
θ	0°	8°	0°	8°

SOP8 Suggested Pad Layout

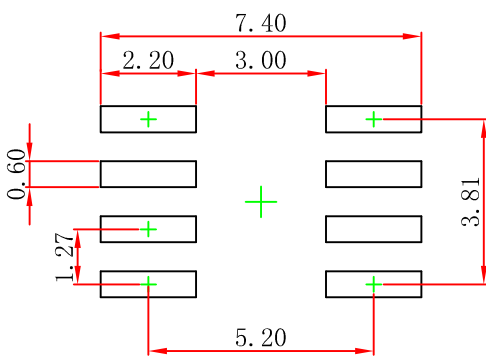

Note:

1. Controlling dimension: in millimeters.
2. General tolerance: $\pm 0.05\text{mm}$.
3. The pad layout is for reference purposes only.

NOTICE

JSCJ reserves the right to make modifications, enhancements, improvements, corrections or other changes without further notice to any product herein. JSCJ does not assume any liability arising out of the application or use of any product described herein.

SOP8 Tape and Reel

SOP8 Embossed Carrier Tape

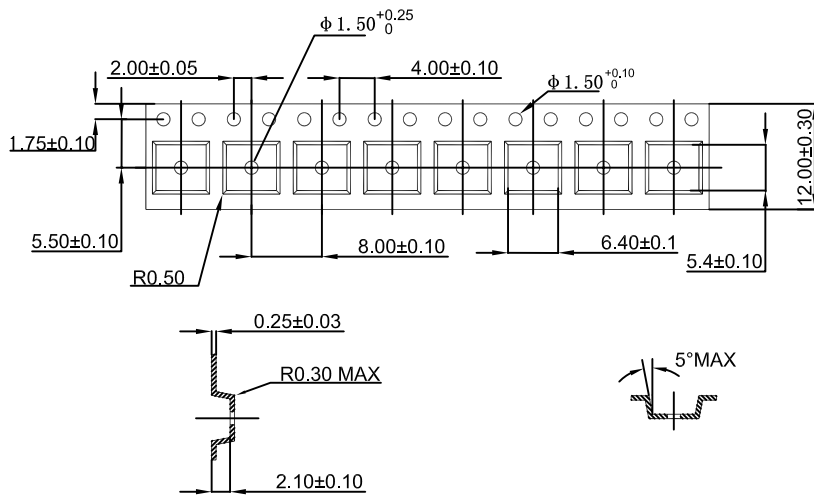

Packaging Description:

SOP8 parts are shipped in tape. The carrier tape is made from a dissipative (carbon filled) polycarbonate resin. The cover tape is a multilayer film (Heat Activated Adhesive in nature) primarily composed of polyester film, adhesive layer, sealant, and anti-static sprayed agent. These reeled parts in standard option are shipped with 2,500 units per 13" or 33cm diameter reel. The reels are clear in color and is made of polystyrene plastic (anti-static coated).

ALL DIM IN mm

SOP8 Tape Leader and Trailer

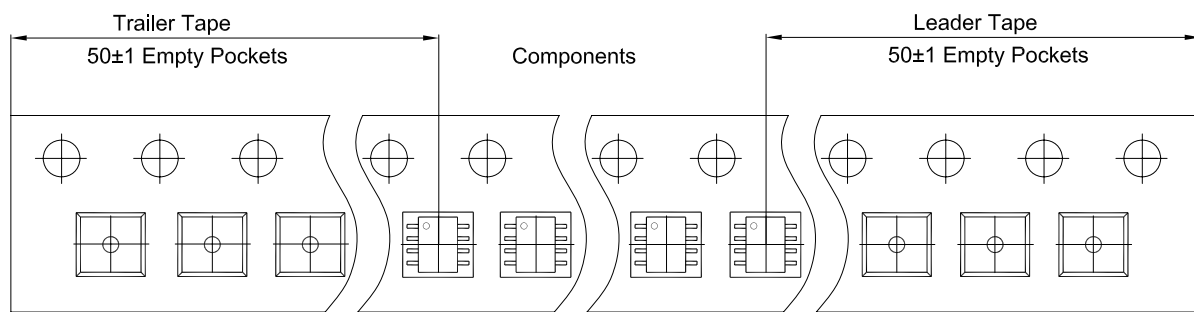

SOP8 Reel

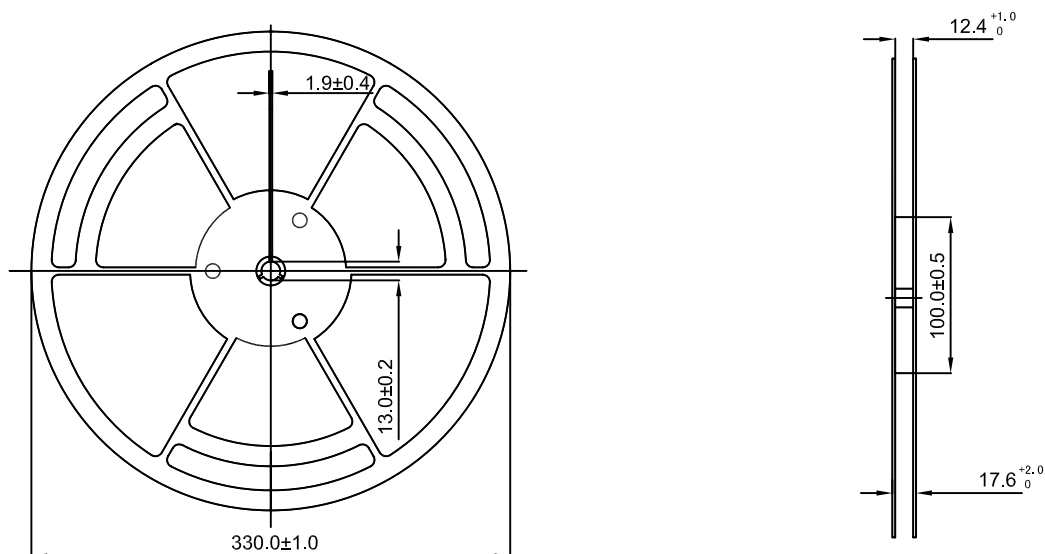

REEL	Reel Size	Box	Box Size(mm)	Carton	Carton Size(mm)	G.W.(kg)
2,500 pcs	13 inch	5,000 pcs	336×336×48	40,000 pcs	445×355×365	

X-ON Electronics

Largest Supplier of Electrical and Electronic Components

Click to view similar products for [MOSFET](#) category:

Click to view products by [CJ](#) manufacturer:

Other Similar products are found below :

[614233C](#) [648584F](#) [MCH3443-TL-E](#) [MCH6422-TL-E](#) [FDPF9N50NZ](#) [FW216A-TL-2W](#) [FW231A-TL-E](#) [APT5010JVR](#) [NTNS3A92PZT5G](#)
[IRF100S201](#) [JANTX2N5237](#) [2SK2464-TL-E](#) [2SK3818-DL-E](#) [FCA20N60_F109](#) [FDZ595PZ](#) [STD6600NT4G](#) [FSS804-TL-E](#) [2SJ277-DL-E](#)
[2SK1691-DL-E](#) [2SK2545\(Q,T\)](#) [D2294UK](#) [405094E](#) [423220D](#) [MCH6646-TL-E](#) [TPCC8103,L1Q\(CM](#) [367-8430-0972-503](#) [VN1206L](#)
[424134F](#) [026935X](#) [051075F](#) [SBVS138LT1G](#) [614234A](#) [715780A](#) [NTNS3166NZT5G](#) [751625C](#) [873612G](#) [IRF7380TRHR](#)
[IPS70R2K0CEAKMA1](#) [RJK60S3DPP-E0#T2](#) [RJK60S5DPK-M0#T0](#) [APT5010JVFR](#) [APT12031JFLL](#) [APT12040JVR](#) [DMN3404LQ-7](#)
[NTE6400](#) [JANTX2N6796U](#) [JANTX2N6784U](#) [JANTXV2N5416U4](#) [SQM110N05-06L-GE3](#) [SIHF35N60E-GE3](#)