

**TSSOP8 Plastic-Encapsulate MOSFETS**

**CJS8810 Dual N-Channel MOSFET**

$V_{(BR)DSS}$	$R_{DS(on)TYP}$	$I_D$
20V	14.2mΩ@4.5V	7A
	15.4mΩ@3.8V	
	18.2mΩ@2.5V	
	26mΩ@1.8V	

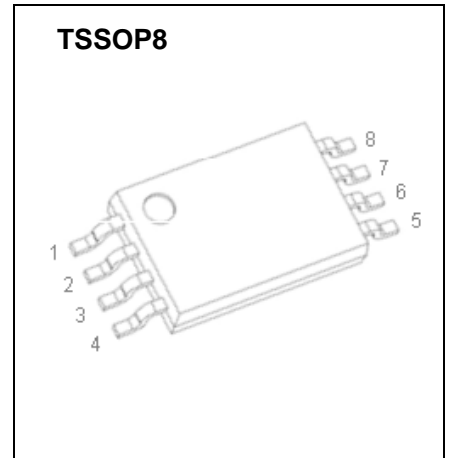

**DESCRIPTION**

The CJS8810 uses advanced trench technology to provide excellent  $R_{DS(ON)}$  and low gate charge. It is ESD protected. This device is suitable for use as a uni-directional or bi-directional load switch, facilitated by its common-drain configuration.

**MARKING:**

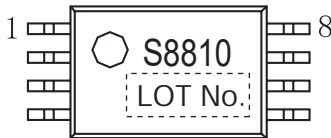

**Equivalent Circuit**

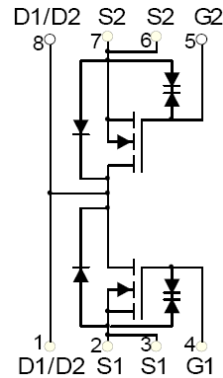

**MAXIMUM RATINGS ( $T_a=25^\circ\text{C}$  unless otherwise noted)**

Parameter	Symbol	Value	Unit
Drain-Source Voltage	$V_{DS}$	20	V
Gate-Source Voltage	$V_{GS}$	±12	V
Continuous Drain Current	$I_D$	7	A
Pulsed Drain Current	$I_{DM}^*$	30	A
Thermal Resistance from Junction to Ambient	$R_{\theta JA}$	62.5	$^\circ\text{C/W}$
Junction Temperature	$T_j$	150	$^\circ\text{C}$
Storage Temperature	$T_{stg}$	-55~+150	$^\circ\text{C}$
Lead Temperature for Soldering Purposes(1/8" from case for 10 s)	$T_L$	260	$^\circ\text{C}$

\*Repetitive rating: Pulse width limited by junction temperature.

# MOSFET ELECTRICAL CHARACTERISTICS

$T_a=25^\circ\text{C}$  unless otherwise specified

Parameter	Symbol	Test Condition	Min	Typ	Max	Unit
<b>STATIC PARAMETERS</b>						
Drain-source breakdown voltage	$V_{(BR)DSS}$	$V_{GS} = 0V, I_D = 250\mu A$	20			V
Zero gate voltage drain current	$I_{DSS}$	$V_{DS} = 16V, V_{GS} = 0V$			1	$\mu A$
Gate-body leakage current	$I_{GSS}$	$V_{GS} = \pm 4.5V, V_{DS} = 0V$			$\pm 1$	$\mu A$
		$V_{GS} = \pm 8V, V_{DS} = 0V$			$\pm 10$	$\mu A$
Gate threshold voltage (note 1)	$V_{GS(th)}$	$V_{DS} = V_{GS}, I_D = 250\mu A$	0.4		1	V
Drain-source on-resistance (note 1)	$R_{DS(on)}$	$V_{GS} = 10V, I_D = 3A$		14	17	m $\Omega$
		$V_{GS} = 4.5V, I_D = 3A$		14.2	19	m $\Omega$
		$V_{GS} = 3.8V, I_D = 3A$		15.4	21	m $\Omega$
		$V_{GS} = 2.5V, I_D = 3A$		18.2	23	m $\Omega$
		$V_{GS} = 1.8V, I_D = 3A$		26	32	m $\Omega$
Forward transconductance (note 1)	$g_{FS}$	$V_{DS} = 5V, I_D = 7A$	9			S
Diode forward voltage (note 1)	$V_{SD}$	$I_S = 1A, V_{GS} = 0V$			1	V
<b>DYNAMIC PARAMETERS (note 2)</b>						
Input Capacitance	$C_{iss}$	$V_{DS} = 10V, V_{GS} = 0V, f = 1MHz$		1150		pF
Output Capacitance	$C_{oss}$			185		pF
Reverse Transfer Capacitance	$C_{rss}$			145		pF
Total gate charge	$Q_g$	$V_{DS} = 10V, V_{GS} = 4.5V, I_D = 7A$		15		nC
Gate-source charge	$Q_{gs}$			0.8		nC
Gate-drain charge	$Q_{gd}$			3.2		nC
<b>SWITCHING PARAMETERS (note 2)</b>						
Turn-on delay time	$t_{d(on)}$	$V_{GS} = 5V, V_{DD} = 10V,$ $R_L = 1.35\Omega, R_{GEN} = 3\Omega$		6		ns
Turn-on rise time	$t_r$			13		ns
Turn-off delay time	$t_{d(off)}$			52		ns
Turn-off fall time	$t_f$			16		ns

**Notes :**

1. Pulse Test : Pulse width  $\leq 300\mu s$ , duty cycle  $\leq 0.5\%$ .
2. Guaranteed by design, not subject to production testing.

# Typical Characteristics

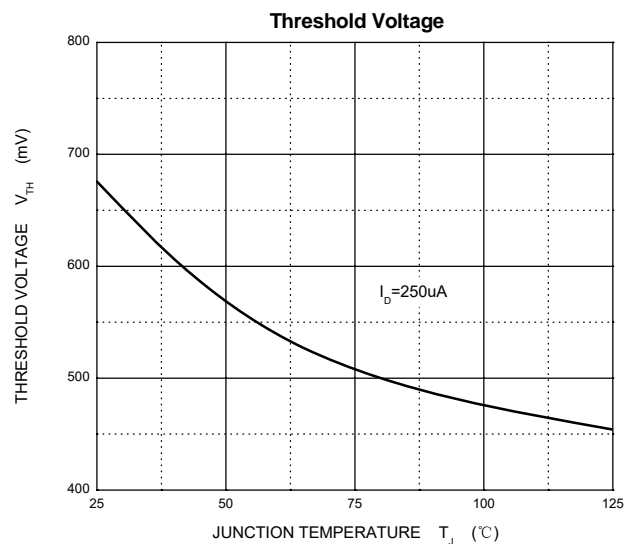
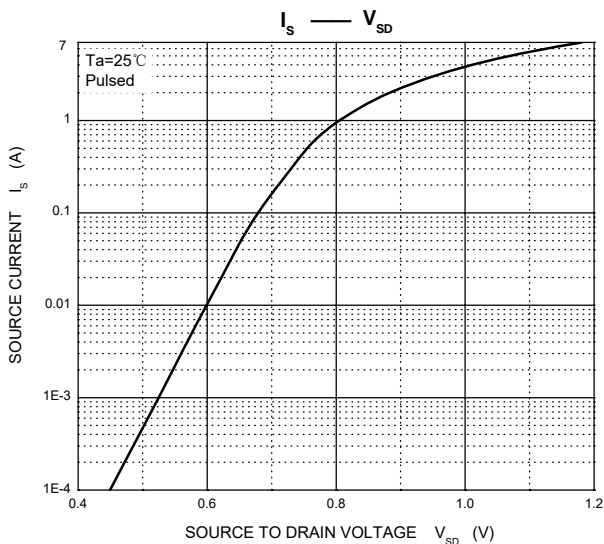
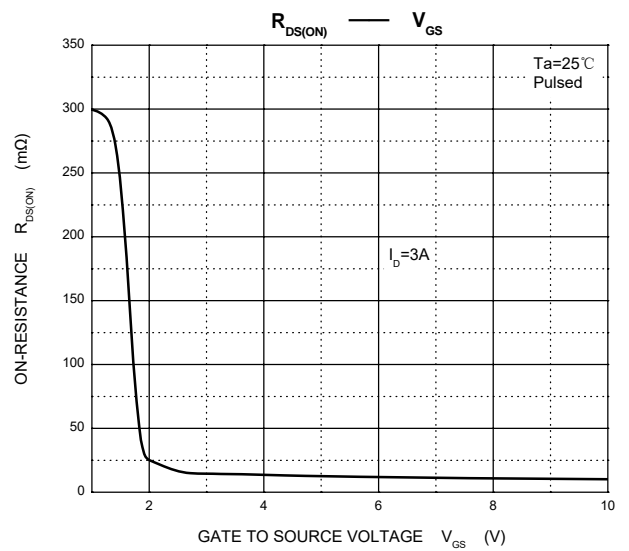
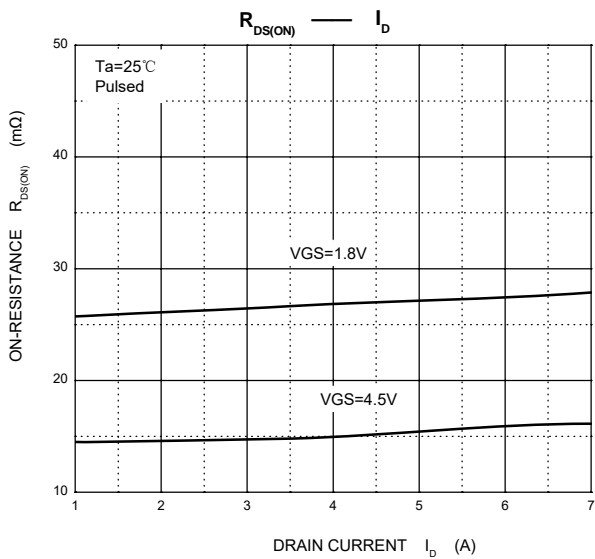
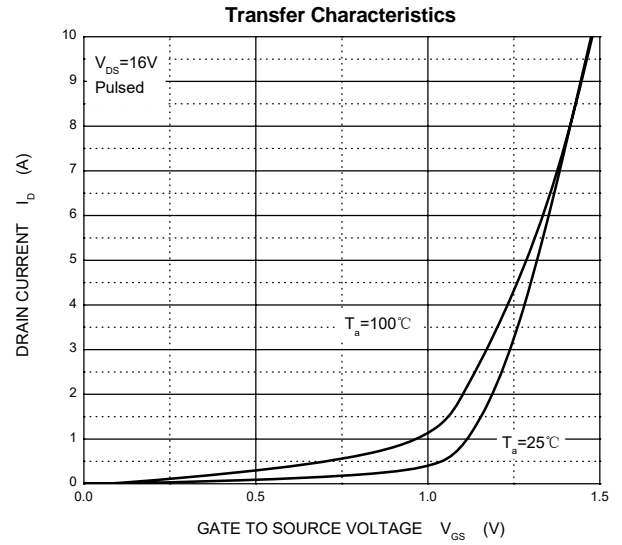
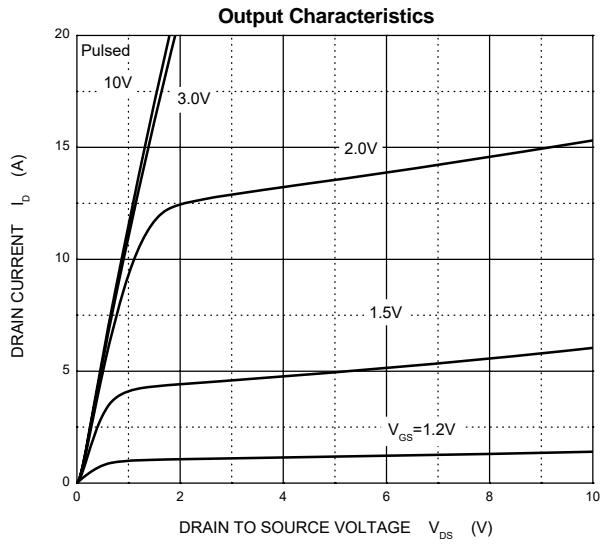

## TSSOP8 Package Outline Dimensions

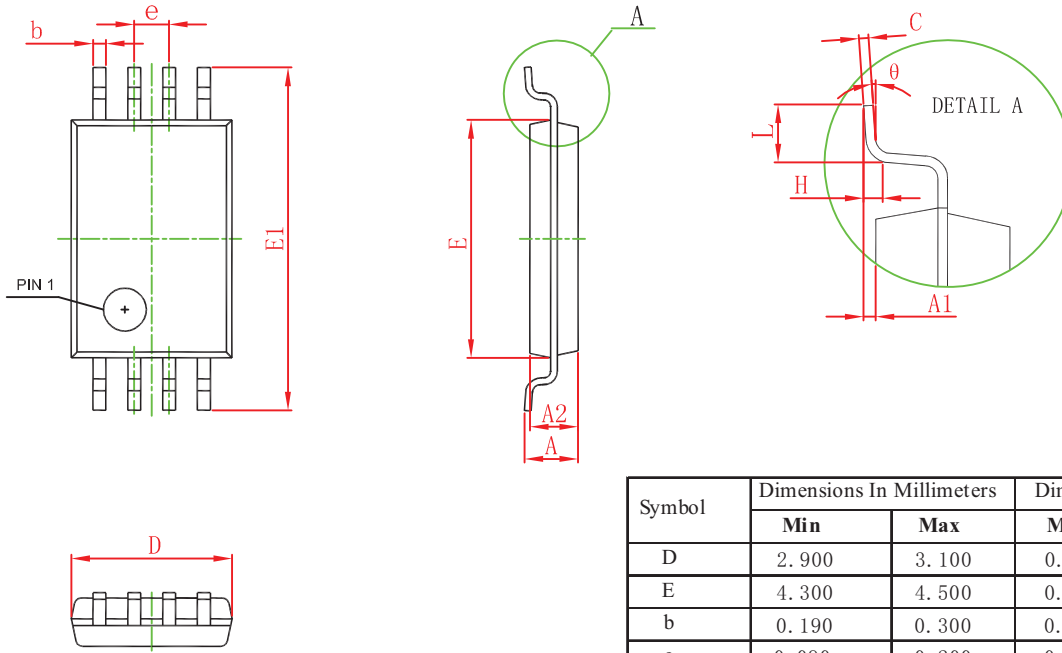

Symbol	Dimensions In Millimeters		Dimensions In Inches	
	Min	Max	Min	Max
D	2.900	3.100	0.114	0.122
E	4.300	4.500	0.169	0.177
b	0.190	0.300	0.007	0.012
c	0.090	0.200	0.004	0.008
E1	6.250	6.550	0.246	0.258
A		1.200		0.047
A2	0.800	1.000	0.031	0.039
A1	0.050	0.150	0.002	0.006
e	0.65 (BSC)		0.026 (BSC)	
L	0.500	0.700	0.020	0.028
H	0.25(TYP)		0.01(TYP)	
$\theta$	1°	7°	1°	7°

## TSSOP8 Suggested Pad Layout

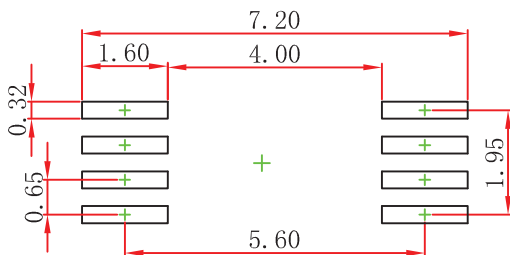

- Note:
1. Controlling dimension: in millimeters.
  2. General tolerance:  $\pm 0.05\text{mm}$ .
  3. The pad layout is for reference purposes only.

### NOTICE

JSCJ reserves the right to make modifications, enhancements, improvements, corrections or other changes without further notice to any product herein. JSCJ does not assume any liability arising out of the application or use of any product described herein.

# TSSOP8 Tape and Reel

## TSSOP8 Embossed Carrier Tape

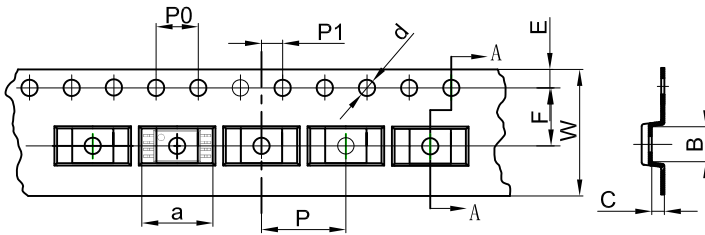

**Packaging Description:**

TSSOP8 parts are shipped in tape. The carrier tape is made from a dissipative (carbon filled) polycarbonate resin. The cover tape is a multilayer film (Heat Activated Adhesive in nature) primarily composed of polyester film, adhesive layer, sealant, and anti-static sprayed agent. These reeled parts in standard option are shipped with 3,000 units per 13" or 33cm diameter reel. The reels are clear in color and is made of polystyrene plastic (anti-static coated).

ALL DIM IN mm

Dimensions are in millimeter										
Pkg type	a	B	C	d	E	F	P0	P	P1	W
TSSOP8	6.76	3.30	1.20	Ø1.50	1.75	5.50	4.00	8.00	2.00	12.00

## TSSOP8 Tape Leader and Trailer

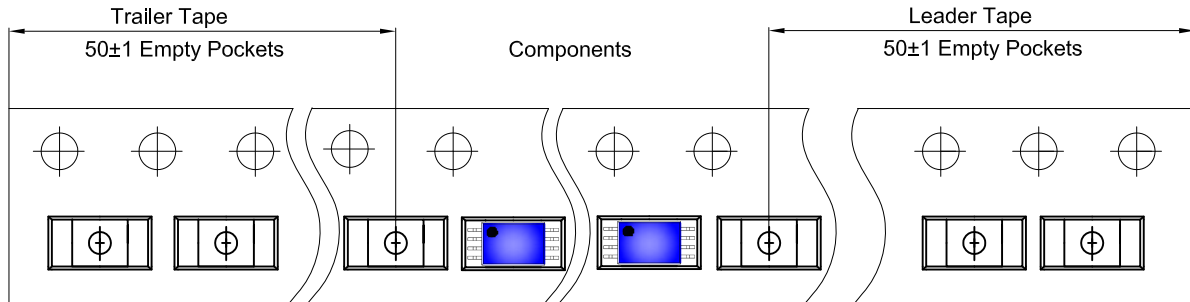

## TSSOP8 Reel

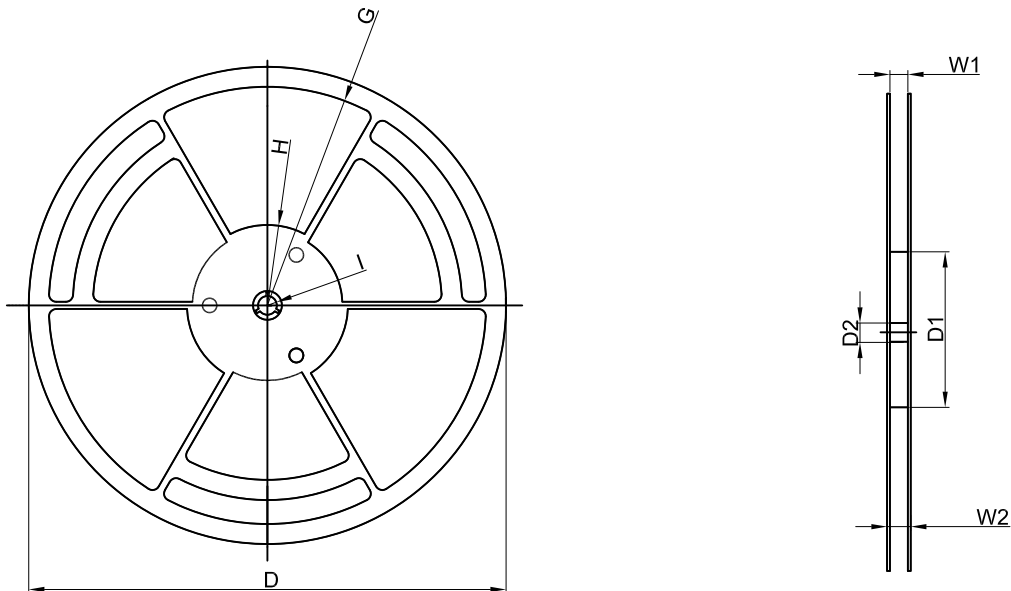

Dimensions are in millimeter								
Reel Option	D	D1	D2	G	H	I	W1	W2
13"Dia	Ø330.00	100.00	13.00	R151.00	R56.00	R6.50	12.40	17.60
REEL	Reel Size	Box	Box Size(mm)	Carton	Carton Size(mm)	G.W.(kg)		
3,000 pcs	13 inch	3,000 pcs	336×336×48	24,000 pcs	445×355×365			

## X-ON Electronics

Largest Supplier of Electrical and Electronic Components

*Click to view similar products for [MOSFET](#) category:*

*Click to view products by [CJ](#) manufacturer:*

Other Similar products are found below :

[614233C](#) [648584F](#) [MCH3443-TL-E](#) [MCH6422-TL-E](#) [FDPF9N50NZ](#) [FW216A-TL-2W](#) [FW231A-TL-E](#) [APT5010JVR](#) [NTNS3A92PZT5G](#)  
[IRF100S201](#) [JANTX2N5237](#) [2SK2464-TL-E](#) [2SK3818-DL-E](#) [FCA20N60\\_F109](#) [FDZ595PZ](#) [STD6600NT4G](#) [FSS804-TL-E](#) [2SJ277-DL-E](#)  
[2SK1691-DL-E](#) [2SK2545\(Q,T\)](#) [D2294UK](#) [405094E](#) [423220D](#) [MCH6646-TL-E](#) [TPCC8103,L1Q\(CM](#) [367-8430-0972-503](#) [VN1206L](#)  
[424134F](#) [026935X](#) [051075F](#) [SBVS138LT1G](#) [614234A](#) [715780A](#) [NTNS3166NZT5G](#) [751625C](#) [873612G](#) [IRF7380TRHR](#)  
[IPS70R2K0CEAKMA1](#) [RJK60S3DPP-E0#T2](#) [RJK60S5DPK-M0#T0](#) [APT5010JVFR](#) [APT12031JFLL](#) [APT12040JVR](#) [DMN3404LQ-7](#)  
[NTE6400](#) [JANTX2N6796U](#) [JANTX2N6784U](#) [JANTXV2N5416U4](#) [SQM110N05-06L-GE3](#) [SIHF35N60E-GE3](#)