

LUMOTAST 75 IP40 - Illuminated pushbutton, protruding lens, round collar, momentary, housing
1.15.108.452/0000



General information

Form of lens	protruding lens
Form of collar	round
Color of collar	black

Dimensions

Diameter of collar	18 mm
Overall height	7.5 mm
Mounting depth	41.5/49.5/57.5 mm
Mounting hole	16.2 mm

Mechanical design

Mounting	ring nut
Terminals	solder terminals
Contact system	snap-action bridge contact
Contact function	momentary
Contact arrangement	2 NC + 2 NO
Contact materials	Ag
Illumination	LED
Lamp socket	T 4.5

Mechanical characteristics

Operating force max.	3 ... 6.5 N
Operating travel	2.7 mm
Switching travel NC	1.6 mm
Switching travel NO	0.9 mm
Robustness max.	100 N

Electrical characteristics

Rated voltage AC max.	250 V
Rated voltage DC max.	230 V
Rated voltage AC/DC min.	12 V
Rated current AC max.	4 A
Rated current DC max.	0.2 A
Rated current AC/DC min.	5 mA
Contact resistance acc. to life max.	200 mΩ
Protection class	II
ESD-strength min.	14 kV

Other specifications

Operating life, at 250 V/2 A (operations)	200,000 (momentary) cycle
---	---------------------------

Operating life, at 250 V/4 A (operations)	60,000 (momentary), 10,000 (latching)
Degree of protection from front side	IP40 (DIN EN 60529)
Operation temperature min.	-25 °C
Ambient temp. operating max. without lamp / LED	+70 °C
Ambient temp. operating max. with lamp /LED	+55 °C
Storage temperature min.	-40 °C
Storage temperature max.	+80 °C
Environmental resistance	acc. to IEC 60068-2-14, -30, -33 and -78
Approvals	ENEC 25 T 55 (70), UL, CSA
Hot wire ignition acc. to IEC 60695-2-1	yes
ROHS compliant	yes
REACH compliant	yes

Mounting hole

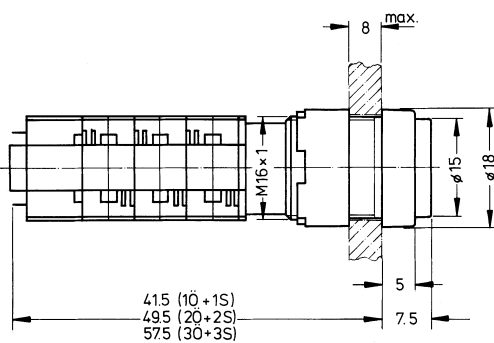
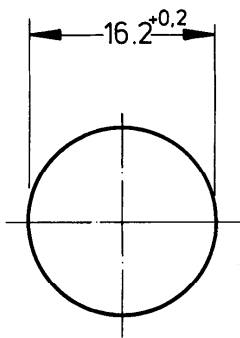

X-ON Electronics

Largest Supplier of Electrical and Electronic Components

Click to view similar products for [Pushbutton Switches](#) category:

Click to view products by [C&K](#) manufacturer:

Other Similar products are found below :

[8940K2012](#) [LW1L-M1C10V-A](#) [LW1L-M1C70-A](#) [LW2L-A1C20M-GD](#) [LW2L-M1C20M-A](#) [60324L](#) [M22-D-R-GB0/K11](#) [M7E-HRN2](#)
[67021K512](#) [67081K512X](#) [701PB580](#) [7199K101](#) [810K12910](#) [810KSV30B](#) [MML21EA2ADK](#) [MML21KA3ABK](#) [MML23KA3AC05K-001](#)
[MML23KW3AA01W](#) [8418K2](#) [8442K3](#) [8450K1](#) [860K11911T01A](#) [861901](#) [861K11911T01A07](#) [861K13810T00A14](#) [861K13911](#)
[8646AB6X718UL](#) [8646ABUL](#) [9001KXRK](#) [907AYY100](#) [PMHD155A1](#) [9533CD4+U574+U4922](#) [95-414.000](#) [99-450.837](#) [99-453.837](#)
[PV3H2B0NN-341](#) [1203MRA](#) [A22NZBGANGA](#) [A22NZBNANGA](#) [A22NZMPATRA](#) [A2PMA1X03EC56](#) [A3A-5123-02](#) [A3A-7140](#) [A3A-7310](#) [A3A-7340](#) [A3U-TMW-A2C-5M](#) [A595](#) [12037A2ULCSA](#) [ABD122N-B](#) [1211390004](#)