



**GET IN
TOUCH**

WITH OUR COMPONENTS

Electromechanical Components

TABLE OF CONTENTS

ELECTROMECHANICAL COMPONENTS

PUSHBUTTONS

LUMOTAST FK
LUMOTAST 25
LUMOTAST 75 IP40
LUMOTAST 75 IP65
Other keylock switches
Other pushbuttons

1

CONTROL COMPONENTS

RAFIX 16
RAFIX 22 QR
RAFIX 22 FS+
RAFIX 22 FSR
RAFIX 30 FS+
RAFIX FS technology – Contact blocks
RAFIX FS technology – Special accessories

2

SIGNAL LAMPS

Signal lamps with integrated LED
Signal lamps with integrated lamp

3

PCB KEYSWITCHES

MICON 5 short-travel keyswitches
RACON short-travel keyswitches
RF short-travel keyswitches
KN 19 short-travel mains switches
RK 90 keycaps
RG 85 III short-travel system
RS 76 full-travel keyswitches
Keylock and rotary switches for PCBs

4

ACCESSORIES

Luminous elements
Other accessories

5

APPENDIX

Glossary
Reference number guide

6



WHO WE ARE

RAFI is one of the world's leading suppliers of efficient solutions for human-machine communication – for over 100 years now. With about 2,000 employees, the RAFI Group is characterised by independence, healthy growth and profitability. Our long-standing customer relationships are based on our internationally superior performance, quality and cross-industry experience. When developing complex solutions, we place great emphasis on involving the customer in the process – from the very start. This helps to build customer satisfaction as well as very stable relationships.

RAFI products are also very impressive in terms of their quality and sustainability. Their quality is dictated by the customers' needs and requirements. Legal regulations can also play a role, along with the

current state of the art. Economical use of natural resources is an important aspect of the RAFI corporate philosophy. The company's environmental management system is certified according to ISO 14001.

Subsidiaries and locations

The company originally founded in 1900 by Ernst Bucher in Ravensburg, Germany as "Optisches, mechanisches und elektrotechnisches Institut" has evolved to become today's RAFI Group with subsidiaries in China, France, Italy, Hungary and the USA. Thanks to its own in-house sales staff and field service as well as a dense worldwide network of dealers and distributors, RAFI is extremely flexible and can always be reached by its customers.



RAFI Electronics

WHAT WE DO

As a business, we hold a solid position in the market for electromechanical components, complete control systems as well as electronic assemblies and devices.

From buttons, switches, signal lamps, PCB keyswitches and short-travel keyswitches to control and signalling units, all of our products stand out for their reliability and long operating life. We deliver solutions that meet your needs, and if you cannot use a standard product, we will custom-manufacture a product to fulfil your specific requirements.

Moreover, we are known as pioneers in the world of industrial touch data entry systems, providing clever solutions with just the right effect – RAFI is always one step ahead. Let us help you to obtain efficient and cost-effective production of your goods.



RAFI Berg/Ravensburg

Certifications:

DIN EN ISO 9001: 2008
DIN EN ISO 9001: 2008 with Road Traffic Regulations,
EN ISO 13485: 2003
ISO /TS 16949: 2009,
DIN EN ISO: 2004 + Cor 1: 2009



CONTROL SYSTEMS: This is the classic application for our components: short-travel keyswitches below an overlay or RAFIX control components and emergency stop buttons for control and safety functions. Also available as an additional input element for touchscreen units.



CONSUMER GOODS: Our components turn up in countless everyday consumer goods – and not just in washing machines. In most cases, they are customer-specific developments or standard components that have been transformed in some way.



AUTOMOTIVE INDUSTRY: Controls for inside of vehicles are our speciality, involving steering wheels, consoles, door handles as well as remote control systems. Example: A typical overhead control panel contains up to 20 MICON short-travel keyswitches, working together to give the vehicle a highly exclusive brand feeling.

While the contact that is made might only last for seconds and be barely perceptible, its effect is usually far greater.

Whenever someone presses a key, flips a switch or operates a joystick, a reaction is triggered, causing something to happen. Since people usually do not give these fleeting moments a second thought, many of our products go unnoticed in everyday life.

Upon closer examination, however, it is clear that RAFI products are used day after day in all sorts of modern consumer goods in a wide range of situations. From pushbuttons, signal lamps, keylock switches, signalling units and PCB keyswitches to short- and full-travel keyswitches, we have prepared an overview of the various core industries where our products are commonly used.

INDUSTRIES

ELEVATOR AND TRANSPORT SYSTEMS: We supply elevator, cabin and display panels to elevator manufacturers for all types of buildings, including optional digital printing with custom designs for any location. Vandal-proof buttons are used, just in case ...



SPECIAL MECHANICAL ENGINEERING: The RG 85 button system was originally developed for vending machines and elevators. Nowadays, coffee machines are controlled using capacitive switches and systems, with intuitive operation and guaranteed hygiene being critical features. Of course, it is all made by RAFI.



TELECOMMUNICATIONS: We rank among the ten largest providers of electronic manufacturing services in Germany. Our customers include the market leader for broadband terminal equipment and smart home products. Any RAFI customer who relies on electronic circuitry will benefit from our advanced expertise.



CLEARLY THE RIGHT SOLUTION FOR YOUR APPLICATION

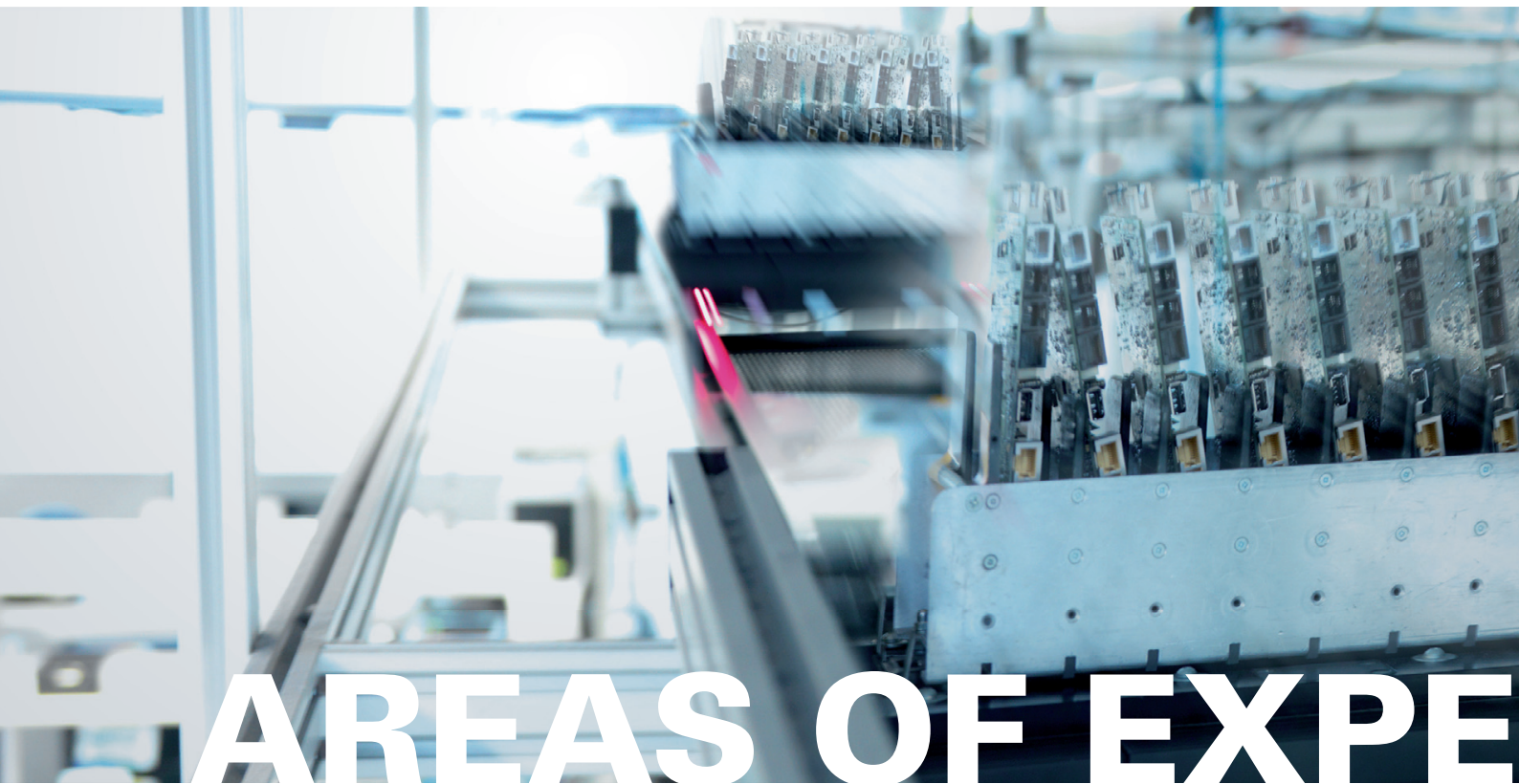

AREAS OF EXPE

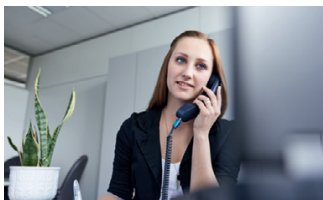

SALES: We like to keep the focus on our customers. We will work together with you from the start to develop the best solution to meet your needs. Our industry-oriented sales structure reflects our consistent customer focus around the globe.

Within our sales divisions, different industries are handled by independent teams under the leadership of key account managers. This highly targeted approach ensures that our customers receive optimum care and support. We speak your language.



PRODUCTION: From contact technology, plastic injection moulding, sheet metal machining, printing technology and mechanics all the way to electronics, we have a broad spectrum of production capabilities – subject to clearly defined quality standards and optimum cost-effectiveness.



DEVELOPMENT: Ranging from development to product realization and series production, we possess development expertise covering the entire production process. This includes development of mechanics, electronics, and software.

All of this is based on state-of-the-art technologies and simulation tools as well as highly efficient processes. Our development teams accompany products from the initial idea to series-production readiness, ensuring top quality along with comprehensive after-sales service.







MATERIALS MANAGEMENT: Our materials management covers everything from purchasing and order processing to logistics. Purchasing is divided into strategic and operational areas to ensure we remain competitive in the international marketplace. Order processing aims to achieve the optimum balance between cost-effectiveness and availability.



AN INTEGRATED SUPPLY CHAIN WITH CAREFULLY TAILORED CONCEPTS.







PRODUCT OVERVIEW

ELECTROMECHANICAL COMPONENTS

PUSHBUTTONS						
						
	LUMOTAST FK	LUMOTAST 25	LUMOTAST 75	Keylock switches	Other pushbuttons	RAFIX 16/ RAFIX 16 F
Panel cut-out	Ø 16.2 mm	Ø 16.2 mm	Ø 16.2 mm	Ø 16.2 mm	Ø 9.1/20.3 mm	Ø 16.2 mm □ 23.1 mm Ø 22.3 mm
Contacts	1 NO	1 NO	1 NC + 1 NO 2 NC + 2 NO	1 to 4 NO	1 NC, 1 NO, 1 NC + 1 NO, 2 NO	1 NC, 1 NO, 1 NC + 1 NO, 2 NC, 2 NO
Contact material	Au	Au	Ag	Au	Ag	Ag / Au
Voltage max./min.	35 V / 0.02 V	35 V / 0.02 V	250 V	35 V	250 V / 0.02 V	250 V / 0.02 V
Current max./min.	100 mA / 0.1 mA	100 mA / 0.1 mA	4 A	100 mA	16 A / 0.1 mA	6 A / 1 mA
Current max./min.	Ribbon cable with connector, PCB plug-in socket	Ribbon cable with connector, PCB plug-in socket	Solder	PCB	Solder, screw, quick connect	Quick-connect, screw, PCB, plug-in socket
Degree of protection	IP 65	IP 65	IP 40 / 65	IP 65	IP 40	IP 65
Terminals	Bi-Pin T1 / T1 1¼	Bi-Pin T1 / T1 1¼	T 4.5	–	BA 9s	W 2 x 4.6d
Lamp socket	Filament lamp, LED	Filament lamp, LED	Filament lamp, LED	–	Filament lamp, LED	Filament lamp, LED
Collar shape	○□□	□	○□□	○□	○	○□
Variants	Illuminated pushbutton, signal lamp	Illuminated pushbutton, EMERGENCY STOP button, keylock switch, selector switch, signal lamp	Illuminated pushbutton, signal lamp, keylock switch	Keylock switch, priority keylock switch	Pushbutton, illuminated pushbutton	Pushbutton, stop button, EMERGENCY STOP button, keylock switch, selector switch, toggle switch, potentiometer drive, signal-lamp unit, signal indicator

PRODUCT OVERVIEW

ELECTROMECHANICAL COMPONENTS

CONTROL COMPONENTS				SIGNAL LAMPS	
					
RAFIX 22 FS+	RAFIX 22 FSR	RAFIX 30 FS+	RAFIX 22 QR	Integrated LED	Integrated neon lamp
Ø 22.3 mm	Ø 22.3 mm	Ø 30.5 mm	Ø 22.3 mm	Ø 5–30 mm	Ø 7–14 mm
1 NC, 1 NO, 1 NC + 1 NO, 2 NC, 2 NO	1 NC, 1 NO, 1 NC + 1 NO, 2 NC, 2 NO	1 NC, 1 NO, 1 NC + 1 NO, 2 NC, 2 NO	1 NC, 1 NO, up to 6 NC, 6 NO	–	–
Ag / Au	Ag / Au	Ag / Au	Ag / Au	–	–
250 V / 0.02 V	250 V / 0.02 V	250 V / 0.02 V	500 V / 0.02 V	28 V	230 V
4 A / 1 mA	4 A / 1 mA	4 A / 1 mA	10 A / 1 mA	0.25 – 1 W	–
PCB, quick-connect (QC)	PCB, quick-connect (QC)	PCB, quick-connect (QC)	Screw, cage clamp, quick-connect	Solder, quick-connect	Solder, quick-connect
IP 65	IP 65 / 69 K	IP 65	IP 65	IP 40	IP 40
–	–	–	BA 9s	None	None
LED, clip	LED, clip	LED, clip	Filament lamp, neon lamp, LED	LED	Neon lamp
□	○	○	□	○△	□↑
Pushbutton, EMERGENCY STOP button, signal indicator, keylock switch, selector switch, potentiometer drive, USB feed- through	Pushbutton, EMERGENCY STOP button, signal indicator, keylock switch, selector switch, USB feedthrough	Pushbutton, signal indicator, keylock switch, selector switch, USB feed- through	Pushbutton, mushroom actuator, EMERGENCY STOP button, twin push- button, signal indica- tor, keylock switch, selector switch, potentiometer drive, signalling unit		

PRODUCT OVERVIEW

ELECTROMECHANICAL COMPONENTS

SHORT-TRAVEL KEYSWITCHES



MICON 5

RACON 8

RACON 12

RF 15/15 H







RF 15 R

RF 15 N

Grid min.	6 x 8 mm	12 mm	15,24 mm	19,05 mm	15,24 mm	15,24 mm
Overall height, min.	3.85 mm, variable	5 mm, variable	5 mm, variable	9.7 / 12.5 mm	9.7 / 12.5 mm	6.2 mm, variable
Contacts	1 NO	1 NO	1 NO	1 NO	1 NO	1 NO
Contact material	Au	Au	Au	Ag / Au	Ag / Au	Ag / Au
Rated voltage	0.02...35 V	0.02...35 V	0.02...35 V	0.02...50 V	0.02...50 V	0.02...50 V
Rated current	0,01...100 mA	0,01...100 mA	0,01...100 mA	0,01...250 mA	0,01...250 mA	0,01...250 mA
Operating travel	0.7 ... 1.1 mm	0.34 mm	0.61 mm	0.5 mm	0.5 mm	0.5 mm
Operating force	3.0 ... 8.0 N	3.3 ... 6.3 N	3.6 ... 9.7 N	2 - 3 N	2 - 3 N	2 - 3 N
Terminals	PCB SMT & THT	PCB SMT & THT	PCB SMT & THT	PCB THT	PCB THT	PCB THT
Illumination	Separate LED	separate LED	separate LED	Full / spot	Full / spot	Full / spot
Operating life min.	250,000 / 1,000,000	1,000,000	1,000,000	1,000,000	1,000,000	1,000,000
Special features	Variable height by use of plungers, different operating forces	Variable height by use of plungers, different operating forces	Variable height by use of plungers, 90° vertical adapter, different operating forces	Variable height by use of plungers, 1-module indicator field		Variable height by use of plungers

PRODUCT OVERVIEW

ELECTROMECHANICAL COMPONENTS

				FULL-TRAVEL KEYSWITCHES		KEYLOCK SWITCHES
						
RF 19/19 H	KN 19	RK 90/II	RG 85 III	RS 76 M	RS 76 C	Keylock switches
23 mm	19,05 x 38,1 mm	12,5 / 19,05 mm	35 mm	19.05 mm	19.05 mm	19.05 mm
9.7 / 12.5 mm	9.7 mm		12.08 mm	15.5 mm	15.5 mm	40 mm
1 NO	1 NC + 1 NO/ 2 NC / 2 NO		1 NO	1 NO	1 NO	1 NO – 4 NO
Ag / Au	Ag		Ag	Au	Contactless	Au
0.02...50 V	12...250 V		3...50 V	2...35 V	4.75...5.25 V	2...35 V
0,01...250 mA	6 A		0,1...250 mA	0.01...100 mA	–	0.01...100 mA
0.5 mm	0.5 mm		1 mm	4 mm	4 mm	1...4 x 90° rotating angle
2 - 3 N	9 ± 3 N		3.5 - 4.5 N	0.9...1.4 N	0.7...1 N	–
PCB THT	PCB THT		8-pin Micro Match connector	PCB THT	PCB THT	PCB THT
Full / spot	Spot	Full	Edge and symbol	Full / spot	Spotl	–
1,000,000	50,000 – 200,000		1,000,000	10,000,000	100,000,000	10,000
Indicator fields 1/2-, 1- and 2-module	Mains switch under overlay or keycaps	Plastic or alumi- nium surface, compatible with MICON, RACON, RF and KN 19	Vandal-proof	Fully illumina- ble keycaps (RS 76 MX)	Very soft stroke, ext- remely long operating life	Degree of protection IP 54, priority keylock switch

NEW PRODUCTS IN THE CATALOGUE

ELECTROMECHANICAL COMPONENTS



GET IN
TOUCH
NEW
PRODUCTS

NEW PRODUCTS IN THE CATALOGUE

ELECTROMECHANICAL COMPONENTS



LUMOTAST 22

E-Stop pushbuttons,
22.3 mm

Page 1 - 87



RAFIX 22 FS⁺

Pushbuttons FLEXLAB

Page 2 - 166



RAFIX 22 FS⁺

Keylock switches
compact

Page 2 - 179



RAFIX 22 FS⁺

Emergency stop
pushbuttons compact

Page 2 - 187



RAFIX 22 FSR

Pushbuttons

Page 2 - 206



RAFIX 22 FSR

Selector switches

Page 2 - 208



RAFIX 22 FSR

Keylock switches

Page 2 - 210



RAFIX 22 FSR

Emergency stop
pushbuttons

Page 2 - 212



RAFIX 22 FSR

Signal indicators

Page 2 - 215



RAFIX 30 FS⁺

Pushbuttons

Page 2 - 221



RAFIX 30 FS⁺

Pushbuttons FLEXLAB

Page 2 - 223



RAFIX 30 FS⁺

Selector switches

Page 2 - 226



RAFIX 30 FS⁺

Keylock switches

Page 2 - 228



RAFIX 30 FS⁺

Lenses

Page 2 - 230



RAFIX 30 FS⁺

USB feedthroughs

Page 2 - 232



RAFIX FS

Short-travel adapters

Page 2 - 258



MICON 5

Plungers round,
ring illumination

Page 4 - 14



MICON 5

Plungers square,
spot-illumination

Page 4 - 22

HOW TO USE THE CATALOGUE

ELECTROMECHANICAL COMPONENTS

Latest online version as the basis for your order

Since this catalogue is published in paper format only at certain intervals, it is not as up-to-date as our website. For this reason, we recommend using the datasheets on our website when ordering standard products.

You can always find the latest information on our products here: <http://www.shop.rafi.de>

Creation of individual datasheets in PDF format

You can create PDF datasheets in our online catalogue at <http://www.shop.rafi.de>. Find the product you want using the search tool or by entering the order number and then click on the "Create datasheet" link.

3D data and 2D drawings

For many of our products, we can provide 3D models in the *.stp file format. For older products, we usually still have dimensional drawings in dxf format. This data can be found in our online catalogue where the individual products are specified: <http://www.shop.rafi.de>

Correction sheets for the printed catalogue

We provide correction sheets on our home page if we discover errors after the catalogue has been printed. Alternatively, you can download the individual (corrected) chapters of this catalogue in PDF format at www.rafi.de/Downloads.

Availability

We always strive to satisfy the needs of our customers. However, it is necessary to mention that our production is contingent on the availability and delivery of the appropriate base materials. Such issues, in addition to changing legislation, can result in modification or discontinuation of our products.

Specifications

The specifications, depictions and other information about our products are merely the results of individual technical inspections. The conditions are derived from the pertinent standards. These inspections should be considered to be independent of one another and they cannot be used to infer possible interactions, especially also in terms of the applicable usage category, installation situation and/or environmental conditions. If you need an evaluation of your application, we will be happy to prepare an offer on request.

Subject to change

We, the RAFI Group, reserve the right to deviate from the specifications in this catalogue, especially in terms of the technical and exterior designs, colours and materials from which the products are manufactured. Excluded from this provision are the basic core functions of our products, on which our customers rely.

Information about our products (e.g. weights, dimensions, practical values, capacity, tolerances and specifications) as well as the depictions (e.g. drawings, CAD data and figures), both in printed and in electronic format, is authoritative only as an approximation unless usability for the express and contractually stipulated purpose requires precise conformity. Such information and depictions do not represent guaranteed quality features but are non-binding descriptions or indicators of the product characteristics. Deviations which are customary in the trade and deviations which are required by law or represent technical improvements, as well as the substitution of components with equivalent parts (form/fit/function), are permissible insofar as they do not impair the usability for the express and contractually stipulated purpose. This applies in particular to spare parts and subsequent orders.

RoHS conformity



The products in this catalogue are RoHS-compliant (RoHS = Restriction of Hazardous Substances).

The components are qualified for lead-free soldering processes. See the glossary for more details.

Terms and conditions

Our current terms and conditions (sales) can be found at www.rafi.de/AGBs.

1

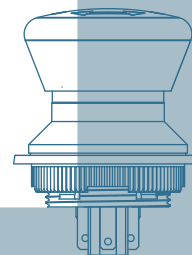

PUSHBUTTONS

LUMOTAST FK	1 - 3
LUMOTAST FK - Illuminated pushbuttons	1 - 7
LUMOTAST FK - Signal lamps	1 - 11
LUMOTAST 25	1 - 15
LUMOTAST 25 - Illuminated pushbuttons	1 - 19
LUMOTAST 25 - Selector switches	1 - 24
LUMOTAST 25 - Keylock switches	1 - 26
LUMOTAST 25 - Emergency stop pushbuttons	1 - 29
LUMOTAST 25 - Signal lamps	1 - 32
LUMOTAST 75 IP40	1 - 35
LUMOTAST 75 IP40 - Illuminated pushbuttons	1 - 37
LUMOTAST 75 IP40 - Keylock switches	1 - 42
LUMOTAST 75 IP40 - Signal lamps with lamp socket T 4.5	1 - 45
LUMOTAST 75 IP65	1 - 49
LUMOTAST 75 IP65 - Illuminated pushbuttons	1 - 51
LUMOTAST 75 IP65 - Signal lamps	1 - 57
Other keylock switches	1 - 63
Keylock switches	1 - 65
Priority keylock switches	1 - 68
Other pushbuttons	1 - 73
Pushbuttons non-illuminated - mounting hole diameter 9.1 mm	1 - 75
Pushbuttons illuminated - mounting hole diameter 9.1 mm	1 - 77
Pushbuttons non-illuminated - mounting hole diameter 15.2 mm	1 - 79
Pushbuttons non-illuminated - mounting hole diameter 16.2 mm	1 - 81
Pushbuttons non-illuminated - mounting hole diameter 18.2 mm	1 - 83
Pushbuttons illuminated - mounting hole diameter 20.3 mm, BA9s	1 - 85
- NEW - LUMOTAST 22 - E-Stop, mounting hole diameter 22.3 mm	1 - 87

PUSHBUTTONS

GENERAL INFORMATION

1

Concepts

1. Momentary pushbuttons are switching elements which are used for making or breaking contact while they are being pressed.
 2. Latching pushbutton are used for making or breaking contact until they are returned to their initial position by being pressed again.
 3. Illuminated pushbuttons have the same functions as described for (1) and (2) and feature an additional lamp socket for accomodating a filament, neon lamp or LED.
 4. Legending can ce effected using kabel holders, legend inserts, by engraving or hot stamping. Grooved transparent lenses are not suitable for legending.
-

CE-Conformity

The products of the Chapter "Pushbuttons" can – relating to the CE-conformity according to the Low-Voltage Directive 73/23/EEG – be divided into the following groups:

Emergency-stop components with an operating voltage < 50 V

F. ex. LUMOTAST 25 emergency-stop. For this pushbutton the Machine Directive 89/392/EEG applies.

All products with an operating voltage > 50 V

For these elements the Low-Voltage Directive 72/23/EEG applies.

All products with an operating voltage < 50 V

For these products no directive applies.

Single parts, accessories and illumination

For these products no directive applies.

EMC-Law

The components of this catalogue are within the meaning of the law concerning the Electromagnetic Conformity (= EMC-Law) "basic components as, f. ex., switches, signal lamps or like" and, therefore, do not fall within the scope of the EMC-Law.

Marking

The marking will be corresponding to the Low-Voltage Directive 73/23/EEG resp. the Directive "CE-Marking 93/68/EEG" either on the packing or on the product itself.



LUMOTAST FK

LUMOTAST FK - Illuminated pushbutton range

- Illuminable pushbuttons and signal lamps with lamp socket T 1/T 1¼.
 - Mounting hole diameter 16.2 mm
 - 35 V / 100 mA max.
 - Degree of protection: IP65 acc. to DIN EN 60529
 - Low profile
 - Keyed socket connector and flat ribbon cable in insulation displacement (IDC) technology or PCB plug-in socket
 - Time-saving click fixing method: Insert pushbutton into front panel and press pushbutton once to fix it.
 - All products are RoHS compliant.
-

PUSHBUTTONS

LUMOTAST FK

1

LUMO
FK

Content

LUMOTAST FK Illuminated pushbuttons

LUMOTAST FK Illuminated pushbutton, round collar

LUMOTAST FK Illuminated pushbutton, square collar

LUMOTAST FK Illuminated pushbutton, rectangular collar

1 - 7

1 - 8

1 - 9

1 - 10

LUMOTAST FK Signal lamps

LUMOTAST FK Signal lamp, round collar

LUMOTAST FK Signal lamp, square collar

LUMOTAST FK Signal lamp, rectangular collar

1 - 11

1 - 12

1 - 13

1 - 13

Series LUMOTAST FK

16.2 mm mounting hole diameter

Mounting

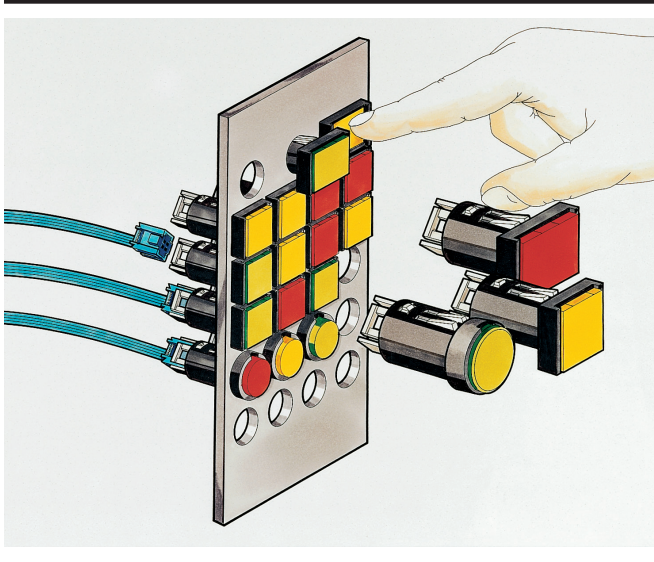

- ① pushbutton as supplied
- ② Insert pushbutton into panel cut-out
- ③ Press once to fit
- ④ Attach connector with flat-ribbon cable

Disassembly from front side

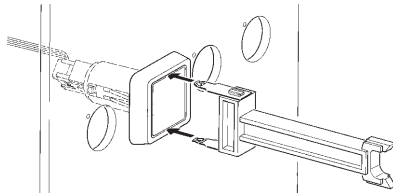

1. Grip body/lens

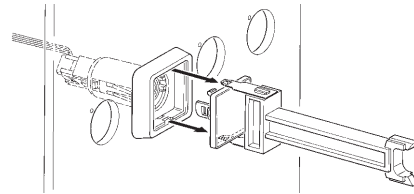

2. Pull out body/lens

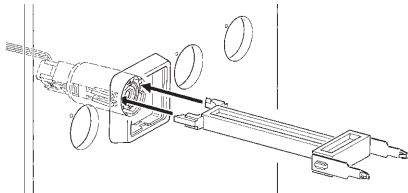

3. Release click lever

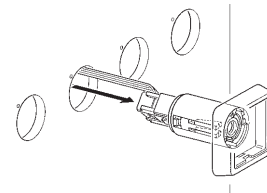

4. Pull out pushbutton/signal lamp with cable

PUSHBUTTONS

LUMOTAST FK - ILLUMINATED PUSHBUTTONS

Dimensional drawing

With quick connector and flat-ribbon cable

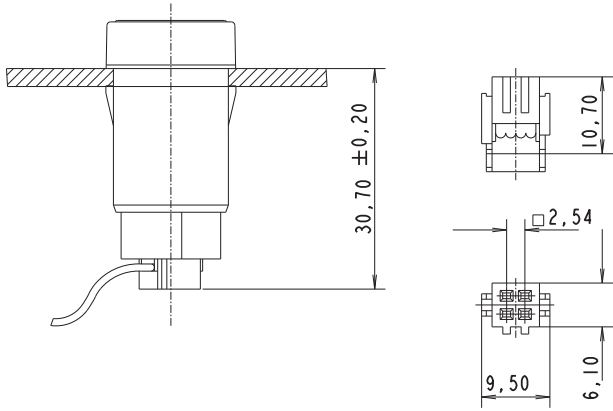

Connection diagram (PCB top view)

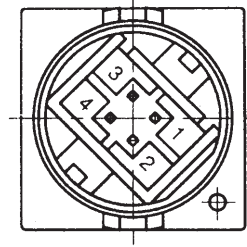

1 + 4 = pushbutton connection, 2 + 3 = lamp connection
If LED is used: connection 3 = cathode

With plug-in socket

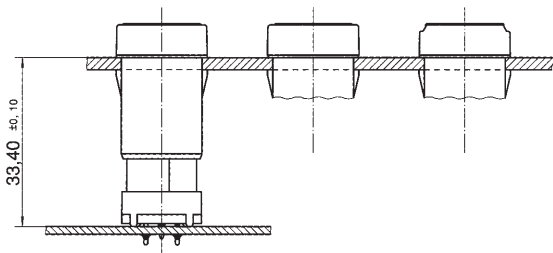

Plug-in socket for PCB

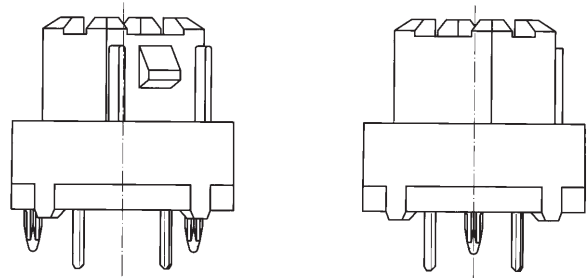

Front panel top view

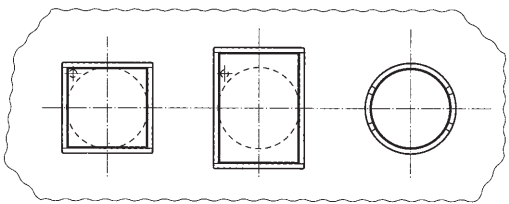

PCB top view

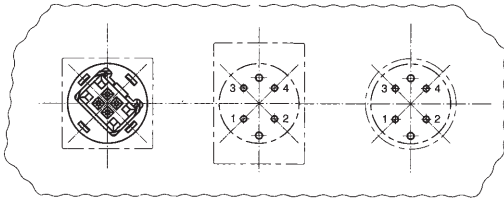

PCB hole diagram
Sight on component side

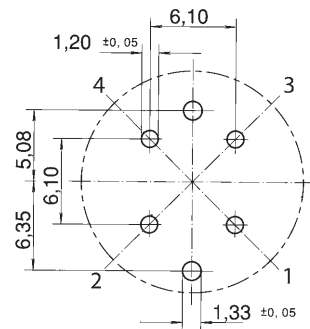

1

LUMO
FK

LUMOTAST FK Illuminated pushbuttons

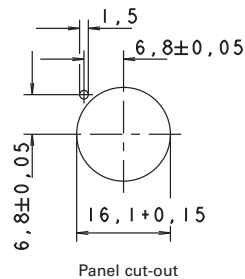

1

LUMO
FK

Technical Data

→ General information

Actuator	flat lens
Color of lens	see order block
Form of collar	see order block

→ Dimensions

Length of collar	see order block
Width of collar	see order block
Diameter of collar	see order block
Overall height	6.6 mm
Mounting depth with connector	30.7 mm
Mounting depth with plug-in socket	33.4 mm
Mounting hole	16.2 mm

→ Mechanical design

Mounting	click quick connection
Terminals	pin connector 4-pole / plug-in socket
Contact system	snap-action contact
Contact function	momentary
Contact arrangement	1 NO
Contact materials	Au
Illumination	yes
Lamp socket	Bi-Pin T1 / T1¼

→ Mechanical characteristics

Operating force max.	6 N
Operating travel	3 mm
Switching travel	1.9 mm
Robustness max.	100 N

→ Electrical characteristics

Rated voltage AC/DC max.	35 V
Rated voltage AC/DC min.	0.02 V
Rated current AC/DC max.	100 mA
Rated current AC/DC min.	0.01 mA
Contact resistance acc. to life max.	300 mΩ
Contact resistance when new max.	100 mΩ
Bouncing time max.	5 ms

→ Other specifications

Operating life (operations)	1,000,000
Degree of protection from front side	IP65 (DIN EN 60529)
Operation temperature min.	-25 °C
Ambient temp. operating max. without lamp /LED	+70 °C
Ambient temp. operating max. with lamp /LED	+55 °C
Storage temperature min.	-40 °C

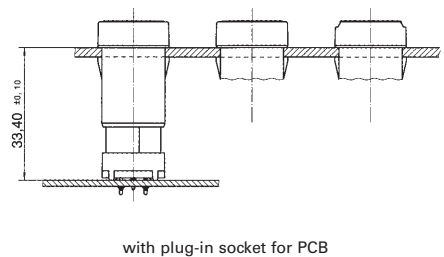
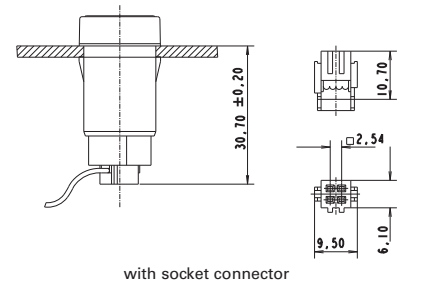

PUSHBUTTONS

LUMOTAST FK - ILLUMINATED PUSHBUTTONS







1

LUMO
FK

- Technical data (continued) – LUMOTAST FK - Illuminated pushbutton

Storage temperature max.	+80 °C
Environmental resistance	acc. to IEC 60068-2-14, -30, -33 and -78
Weight	6 g
ROHS compliant	yes
REACH compliant	yes

Accessories LUMOTAST FK - Illuminated pushbutton

→ Description	Photo	Order no.	Additional accessories see page
Socket Bi-Pin T 1, LED		-	5 - 6
Socket Bi-Pin T 1, LED superbright		-	5 - 6
Plug-in socket for PCB		5.00.645.036/0000	5 - 28
Cable (flat ribbon cable 10 cm with socket connector and male quick connector, AMP 4-pin)		5.03.771.306/0000	5 - 29
Disassembly tool for LUMOTAST FK		5.05.800.041/0000	5 - 27
Flat ribbon cable, 4-wire, 1 m long		5.37.700.124/0000	5 - 28
Socket connector, 4-pin		5.92.025.368/0000	5 - 28



LUMOTAST FK Illuminated pushbutton, round collar

Technical data see page 1 - 7

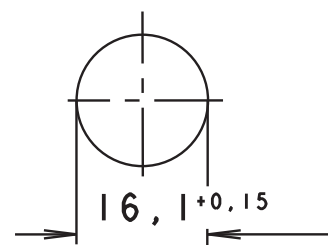
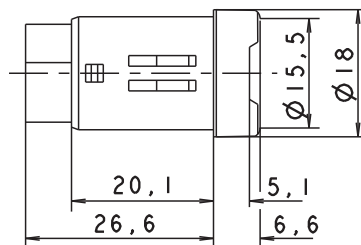

Panel cut-out

→ Contact function	Contact arrangement	Order no.	Note
momentary	1 NO	1.15.114.936/0000	Please include the desired lens in your order.

Note when using LEDs: A notch on the lamp socket identifies the cathode side (-).

– Table (continued) –
LUMOTAST FK - Illuminated pushbutton, round collar

Lenses:

- Lens, round, transparent colorless: 5.49.075.016/1002
- Lens, round, transparent red: 5.49.075.016/1306
- Lens, round, transparent yellow: 5.49.075.016/1403
- Lens, round, transparent green: 5.49.075.016/1505
- Lens, round, transparent blue: 5.49.075.016/1607

LUMOTAST FK Illuminated pushbutton, square collar

Technical data see page 1 - 7

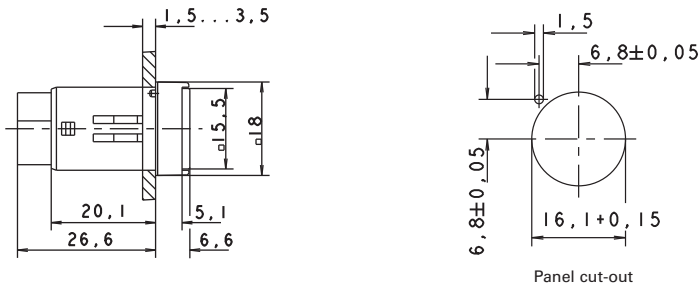

→ Contact function	Contact arrangement	Order no.	Note
momentary	1 NO	1.15.114.906/0000	Please include the desired lens in your order.

Note when using LEDs: A notch on the lamp socket identifies the cathode side (-).

Lenses:

- Lens, square, transparent colorless: 5.49.075.015/1002
- Lens, square, transparent red: 5.49.075.015/1306
- Lens, square, transparent yellow: 5.49.075.015/1403
- Lens, square, transparent green: 5.49.075.015/1505
- Lens, square, transparent blue: 5.49.075.015/1607

PUSHBUTTONS

LUMOTAST FK - ILLUMINATED PUSHBUTTONS



LUMOTAST FK Illuminated pushbutton, rectangular collar

Technical data see page 1 - 7

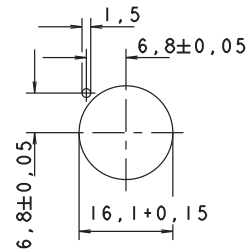
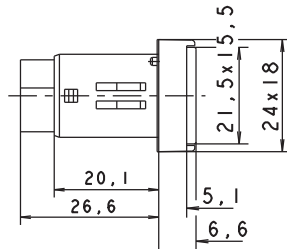

Panel cut-out

→ Contact function	Contact arrangement	Order no.	Note
momentary	1 NO	1.15.114.966/0000	Please include the desired lens in your order.

Note when using LEDs: A notch on the lamp socket identifies the cathode side (-).

Lenses:

Lens, rectangular, transparent colorless: 5.49.075.017/1002

Lens, rectangular, transparent red: 5.49.075.017/1306

Lens, rectangular, transparent yellow: 5.49.075.017/1403

Lens, rectangular, transparent green: 5.49.075.017/1505

Lens, rectangular, transparent blue: 5.49.075.017/1607

LUMOTAST FK Signal lamps

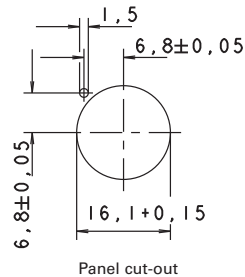

1

LUMO
FK

Technical Data

→ General information

Form of lens	flat lens
Color of lens	see order block
Form of collar	see order block

→ Dimensions

Length of collar	see order block
Width of collar	see order block
Overall height	see order block
Mounting depth with connector	30.7 mm
Mounting depth with plug-in socket	33.4 mm
Mounting hole	16.2 mm

→ Mechanical design

Mounting	click quick connection
Terminals	pin connector 4-pole / plug-in socket
Lamp socket	Bi-Pin T1 / T1¼
Lamp	filament lamp / LED

→ Electrical characteristics

Voltage limit max.	24 V
Power limit max.	0.7 W

→ Other specifications

Degree of protection from front side	IP65 (DIN EN 60529)
Weight	5 g
Operation temperature min.	-25 °C
Ambient temp. operating max.	+55 °C
Storage temperature min.	-40 °C
Storage temperature max.	+80 °C
Environmental resistance	acc. to IEC 60068-2-14, -30, -33 and -78
ROHS compliant	yes
REACH compliant	yes

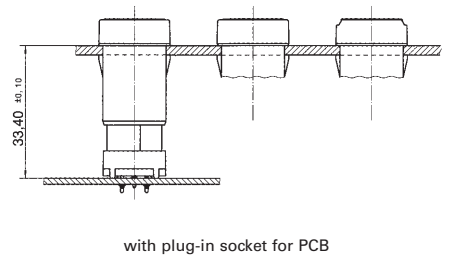
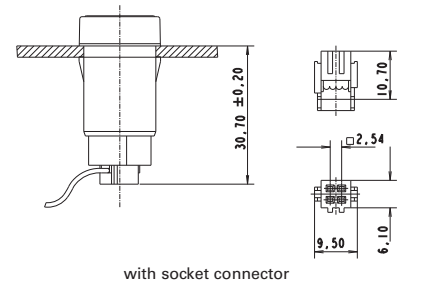

Accessories LUMOTAST FK - Signal lamp

→ Description	Photo	Order no.	Additional accessories see page
Socket Bi-Pin T 1, LED		-	5 - 6
Socket Bi-Pin T 1, LED superbright		-	5 - 6
Plug-in socket for PCB		5.00.645.036/0000	5 - 28





PUSHBUTTONS

LUMOTAST FK - SIGNAL LAMPS

1

LUMO
FK

**- Table (continued) -
Accessories LUMOTAST FK - Signal lamp**

Description	Photo	Order no.	Additional accessories see page
Cable (flat ribbon cable 10 cm with socket connector and male quick connector, AMP 4-pin)		5.03.771.306/0000	5 - 29
Disassembly tool for LUMOTAST FK		5.05.800.041/0000	5 - 27
Flat ribbon cable, 4-wire, 1 m long		5.37.700.124/0000	5 - 28
Socket connector, 4-pin		5.92.025.368/0000	5 - 28



LUMOTAST FK Signal lamp, round collar

Technical data see page 1 - 11

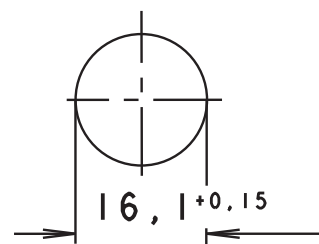
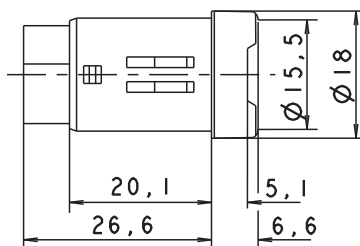

Panel cut-out

Power limit max.	Voltage limit max.	Lamp socket	Order no.	Note
0.7 W	24 V	Bi-Pin T1 / T1¼	1.65.121.936/0000	Please include the desired lens in your order.

Do not press in lens in disassembled condition.

Note when using LEDs: A notch on the lamp socket identifies the cathode side (-).

Lenses:

- Lens, round, transparent colorless: 5.49.075.016/1002
- Lens, round, transparent red: 5.49.075.016/1306
- Lens, round, transparent yellow: 5.49.075.016/1403
- Lens, round, transparent green: 5.49.075.016/1505
- Lens, round, transparent blue: 5.49.075.016/1607

LUMOTAST FK Signal lamp, square collar

Technical data see page 1 - 11

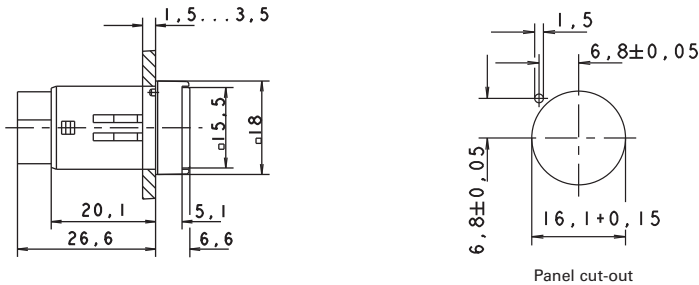

1

LUMO
FK

→ Power limit max.	Voltage limit max.	Lamp socket	Order no.	Note
0.7 W	24 V	Bi-Pin T1 / T1¼	1.65.121.906/0000	Please include the desired lens in your order.

Do not press in lens in disassembled condition.

Note when using LEDs: A notch on the lamp socket identifies the cathode side (-).

Lenses:

Lens, square, transparent colorless: 5.49.075.015/1002

Lens, square, transparent red: 5.49.075.015/1306

Lens, square, transparent yellow: 5.49.075.015/1403

Lens, square, transparent green: 5.49.075.015/1505

Lens, square, transparent blue: 5.49.075.015/1607

LUMOTAST FK Signal lamp, rectangular collar

Technical data see page 1 - 11

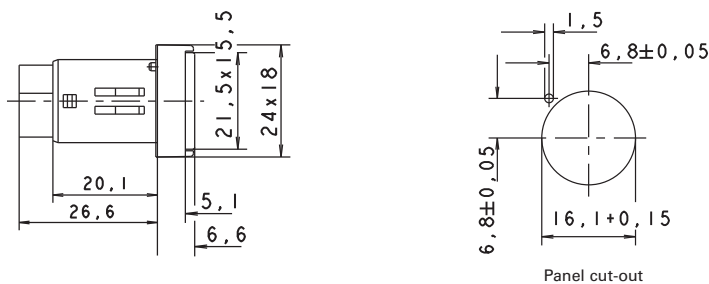

→ Power limit max.	Voltage limit max.	Lamp socket	Order no.	Note
0.7 W	24 V	Bi-Pin T1 / T1¼	1.65.121.966/0000	Please include the desired lens in your order.

Do not press in lens in disassembled condition.

Note when using LEDs: A notch on the lamp socket identifies the cathode side (-).

Lenses:

Lens, rectangular, transparent colorless: 5.49.075.017/1002

PUSHBUTTONS

LUMOTAST FK - SIGNAL LAMPS

– Table (continued) –

LUMOTAST FK - Signal lamp, rectangular collar

Lens, rectangular, transparent red: 5.49.075.017/1306

Lens, rectangular, transparent yellow: 5.49.075.017/1403

Lens, rectangular, transparent green: 5.49.075.017/1505

Lens, rectangular, transparent blue: 5.49.075.017/1607

1

LUMO
FK



LUMOTAST 25

LUMOTAST 25 - Pushbutton range

- Illuminable pushbuttons and signal lamps.
 - Mounting hole diameter: 16.2 mm
 - 35 V / 100 mA max.
 - Degree of protection: IP65 acc. to DIN EN 60529
 - Low profile
 - Lamp socket Bi-Pin T 1 for LEDs and filament lamps
 - Keyed socket connector and flat ribbon cable or PCB plug-in socket
 - Ring nut or click fixing method.
 - All products are RoHS compliant.
-

PUSHBUTTONS

LUMOTAST 25

Content

LUMOTAST 25 Illuminated pushbuttons

LUMOTAST 25 Illuminated pushbutton with flush lens, „Click“ quick-assembly feature	1 - 19
LUMOTAST 25 Illuminated pushbutton with flush lens, ring nut fixing	1 - 21
LUMOTAST 25 Illuminated pushbutton with protruding lens, „Click“ quick-assembly feature	1 - 21
LUMOTAST 25 Illuminated pushbutton with protruding lens, „Click“ quick-assembly feature	1 - 22
LUMOTAST 25 Illuminated pushbutton with protruding lens, ring nut fixing	1 - 23

LUMOTAST 25 Selector switches

LUMOTAST 25 Selector switch, ring nut fixing	1 - 24
--	--------

LUMOTAST 25 Keylock switches

LUMOTAST 25 Keylock switch	1 - 26
----------------------------	--------

LUMOTAST 25 Emergency stop pushbuttons

LUMOTAST 25 Emergency stop pushbutton, ring nut fixing	1 - 29
--	--------

LUMOTAST 25 Signal lamps

LUMOTAST 25 Signal lamp, 24 V, „Click“ quick-assembly feature	1 - 32
LUMOTAST 25 Signal lamp, 24 V, ring nut fixing	1 - 33
LUMOTAST 25 Signal lamp, 24 V, ring nut fixing	1 - 34

1

LUMO
25

Series LUMOTAST 25

16.2 mm mounting hole diameter

Mounting of Click-Version

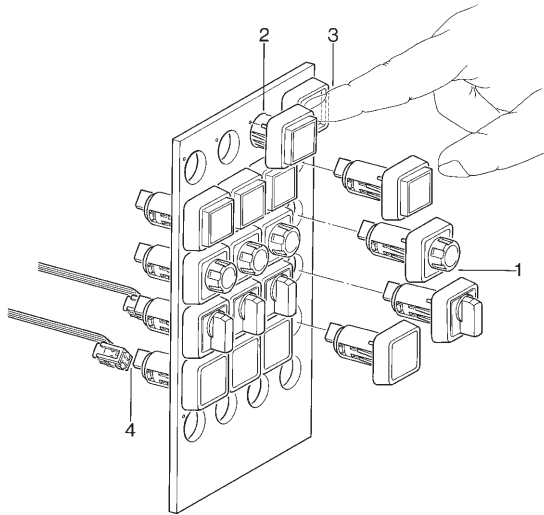

- ① As delivered
- ② Insert pushbutton in hole
- ③ Actuate once
- ④ Insert connector with flat-ribbon cable

Disassembly Click-Version from Front Side

Click-Version from front (only for pushbuttons and signal lamps with special tool for dismounting)

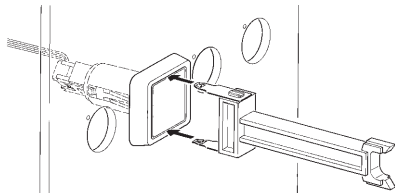

1. Grip body/lens

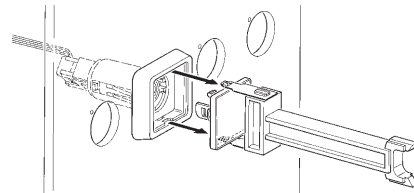

2. Pull out body/lens

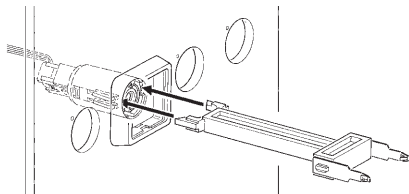

3. Release click lever

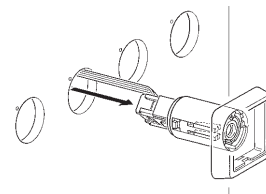

4. Pull out pushbutton/signal lamp with cable

PUSHBUTTONS

LUMOTAST 25 - ILLUMINATED PUSHBUTTONS

Dimensional drawing

With quick connector and flat-ribbon cable

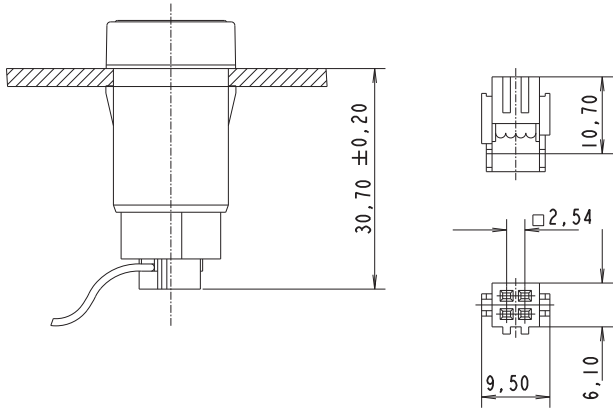

Connection diagram (PCB top view)

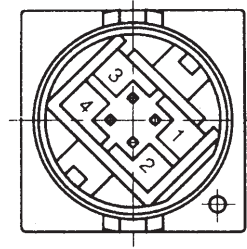

1 + 4 = pushbutton connection, 2 + 3 = lamp connection
If LED is used: connection 3 = cathode

1

LUMO
25

With plug-in socket

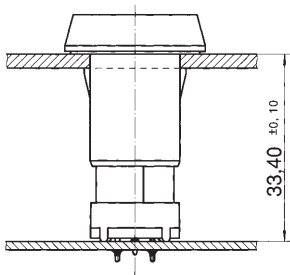

Front panel top view

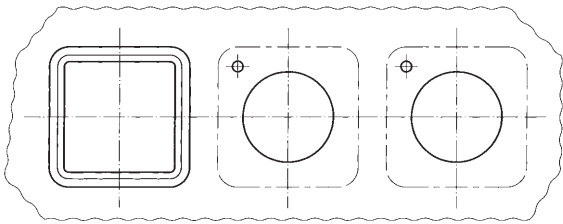

PCB top view

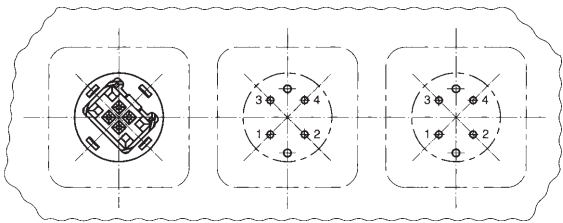

1+4 contact connection
2+3 lamp connection

Plug-in socket for PCB

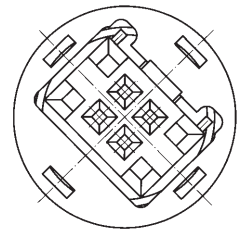
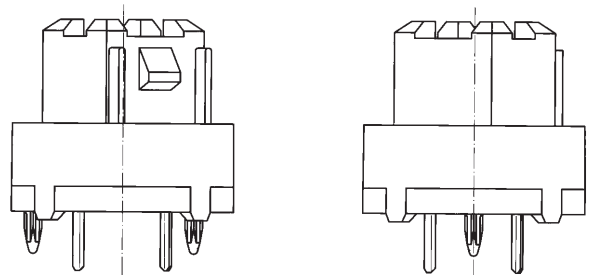

PCB hole diagram
Sight on component side

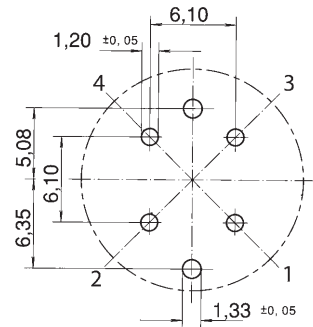

LUMOTAST 25 Illuminated pushbuttons

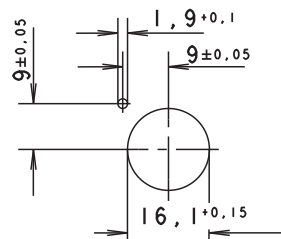

Panel cut-out

Technical Data

→ General information

Form of lens	see order block
Color of lens	see order block
Form of collar	square

→ Dimensions

Length of collar	25 mm
Width of collar	25 mm
Overall height	7.1 mm
Mounting depth with connector	30.7 mm
Mounting depth with plug-in socket	33.4 mm
Mounting hole	16.2 mm

→ Mechanical design

Mounting	see order block
Terminals	pin connector 4-pole / plug-in socket
Contact system	snap-action contact
Contact function	momentary
Contact arrangement	1 NO
Contact materials	Au
Illumination	yes
Lamp socket	Bi-Pin T1 / T1¼

→ Mechanical characteristics

Operating force max.	6 N
Operating travel	3 mm
Switching travel	2 mm
Robustness max.	100 N

→ Electrical characteristics

Rated voltage AC/DC max.	35 V
Rated voltage AC/DC min.	0.02 V
Rated current AC/DC max.	100 mA
Rated current AC/DC min.	0.01 mA
Contact resistance acc. to life max.	100 mΩ
Bouncing time max.	5 ms

→ Other specifications

Operating life (operations)	1,000,000
Degree of protection from front side	IP65 (DIN EN 60529)
Ambient temp. operating max. without lamp /LED	-25 °C
Ambient temp. operating max. without lamp /LED	+70 °C
Ambient temp. operating min. with lamp /LED	-25 °C
Ambient temp. operating max. with lamp /LED	+55 °C

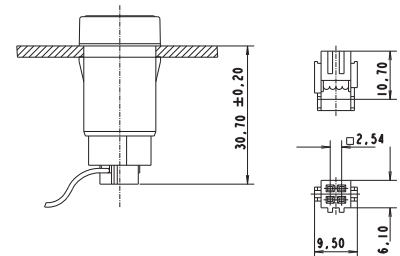

with socket connector

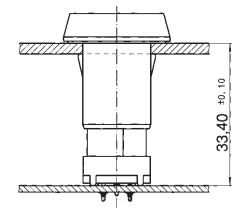

with PCB plug-in socket

PUSHBUTTONS













LUMOTAST 25 - ILLUMINATED PUSHBUTTONS

1

– Technical data (continued) – LUMOTAST 25 - Illuminated pushbutton

Storage temperature min.	-40 °C
Storage temperature max.	+80 °C
Environmental resistance	acc. to IEC 60068-2-14, -30, -33 and -78
Weight	7 g
ROHS compliant	yes
REACH compliant	yes

Accessories LUMOTAST 25 - Illuminated pushbutton

→ Description	Photo	Order no.	Additional accessories see page
Socket Bi-Pin T 1, LED		-	5 - 6
Socket Bi-Pin T 1, LED superbright		-	5 - 6
Plug-in socket for PCB		5.00.645.036/0000	5 - 28
Cable (flat ribbon cable 10 cm with socket connector and male quick connector, AMP 4-pin)		5.03.771.306/0000	5 - 29
Disassembly tool for LUMOTAST 25, RAFIX 16		5.05.800.042/0000	5 - 27
Blanking cap complete with sealing disc and ring nut, square		5.05.800.049/0100	2 - 83, 5 - 23
Label holder, flush, for square collar		5.07.620.004/0000	2 - 80
Flat ribbon cable, 4-wire, 1 m long		5.37.700.124/0000	5 - 28
Fixing spanner M 15, M 16		5.58.002.019/0105	5 - 25
Legend insert, blank, use only for transparent lenses		5.70.635.000/2000	-
Legend label 23 x 16 for label holder, without legend		5.73.111.000/0000	-
Socket connector, 4-pin		5.92.025.368/0000	5 - 28

LUMOTAST 25 Illuminated pushbutton with flush lens, „Click“ quick-assembly feature

Technical data see page 1 - 19

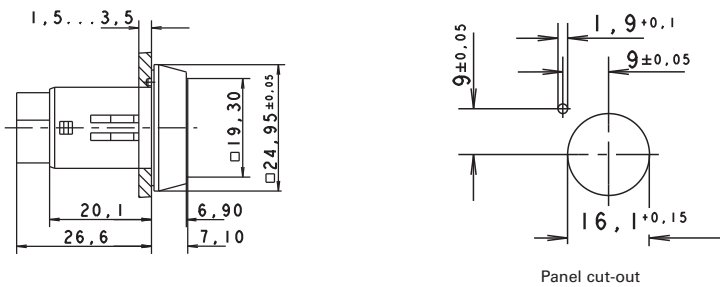

1

LUMO
25

→ Contact function	Contact arrangement	Order no.	Note
momentary	1 NO	1.15.150.506/0000	Please include the desired lens in your order.

Note when using LEDs: A notch on the lamp socket identifies the cathode side (-).

Lenses:

- Lens, square, transparent colorless: 5.49.077.011/1002
- Lens, square, transparent red: 5.49.077.011/1306
- Lens, square, transparent yellow: 5.49.077.011/1403
- Lens, square, transparent green: 5.49.077.011/1505
- Lens, square, transparent blue: 5.49.077.011/1607

LUMOTAST 25 Illuminated pushbutton with flush lens, ring nut fixing

Technical data see page 1 - 19

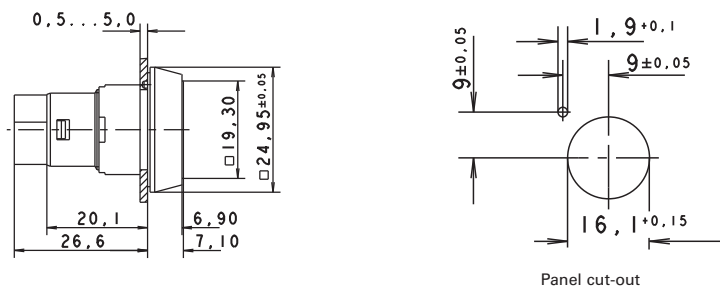

→ Contact function	Contact arrangement	Order no.	Note
momentary	1 NO	1.15.150.556/0000	Please include the desired lens in your order.

Note when using LEDs: A notch on the lamp socket identifies the cathode side (-).

Lenses:

- Lens, square, transparent colorless: 5.49.077.011/1002

PUSHBUTTONS

LUMOTAST 25 - ILLUMINATED PUSHBUTTONS

1

LUMO
25

– Table (continued) –

LUMOTAST 25 - Illuminated pushbutton with flush lens, ring nut fixing

Lens, square, transparent red: 5.49.077.011/1306

Lens, square, transparent yellow: 5.49.077.011/1403

Lens, square, transparent green: 5.49.077.011/1505

Lens, square, transparent blue: 5.49.077.011/1607



LUMOTAST 25 Illuminated pushbutton with protruding lens, „Click“ quick-assembly feature

Technical data see page 1 - 19

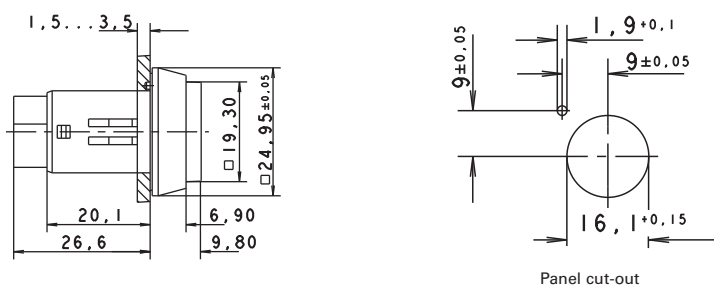

Panel cut-out

→ Contact function	Contact arrangement	Order no.	Note
momentary	1 NO	1.15.150.606/0000	Please include the desired lens in your order.

Note when using LEDs: A notch on the lamp socket identifies the cathode side (-).

Lenses:

Lens, square, transparent colorless: 5.49.077.012/1002

Lens, square, transparent red: 5.49.077.012/1306

Lens, square, transparent yellow: 5.49.077.012/1403

Lens, square, transparent green: 5.49.077.012/1505

Lens, square, transparent blue: 5.49.077.012/1607

LUMOTAST 25 Illuminated pushbutton with protruding lens, ring nut fixing

Technical data see page 1 - 19

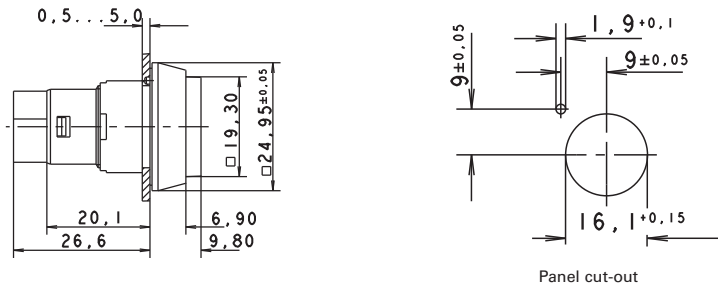

1

LUMO
25

→ Contact function	Contact arrangement	Order no.	Note
momentary	1 NO	1.15.150.656/0000	Please include the desired lens in your order.

Note when using LEDs: A notch on the lamp socket identifies the cathode side (-).

Lenses:

- Lens, square, transparent colorless: 5.49.077.012/1002
- Lens, square, transparent red: 5.49.077.012/1306
- Lens, square, transparent yellow: 5.49.077.012/1403
- Lens, square, transparent green: 5.49.077.012/1505
- Lens, square, transparent blue: 5.49.077.012/1607

PUSHBUTTONS

LUMOTAST 25 - SELECTOR SWITCHES

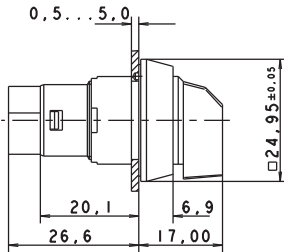

LUMOTAST 25 Selector switches

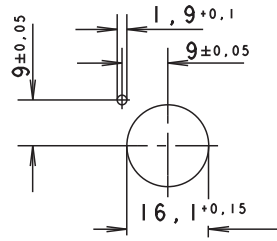

Panel cut-out

Technical Data

→ General information

Actuator	handle
Color of handle	black opaque
Form of collar	square

→ Dimensions

Length of collar	25 mm
Width of collar	25 mm
Overall height	17 mm
Mounting depth with connector	30.7 mm
Mounting depth with plug-in socket	33.4 mm
Mounting hole	16.2 mm

→ Mechanical design

Mounting	see order block
Terminals	pin connector 4-pole / plug-in socket
Contact system	snap-action contact
Contact function	see order block
Contact arrangement	1 NO
Contact materials	Au
Illumination	no

→ Mechanical characteristics

Operating force min.	0.03 Nm
Rotating angle	see order block
Operating force max.	1.5 N

→ Electrical characteristics

Rated voltage AC/DC max.	35 V
Rated voltage AC/DC min.	0.02 V
Rated current AC/DC max.	100 mA
Rated current AC/DC min.	0.01 mA
Contact resistance acc. to life max.	100 mΩ
Bouncing time max.	5 ms







→ Other specifications

Operating life (operations)	500,000
Degree of protection from front side	IP65 (DIN EN 60529)
Operation temperature min.	-25 °C
Ambient temp. operating max.	+70 °C
Storage temperature min.	-40 °C
Storage temperature max.	+80 °C
Environmental resistance	acc. to IEC 60068-2-14, -30, -33 and -78
Weight	8 g
ROHS compliant	yes
REACH compliant	yes

1

LUMO
25

Accessories LUMOTAST 25 - Selector switch

→ Description	Photo	Order no.	Additional accessories see page
Plug-in socket for PCB		5.00.645.036/0000	5 - 28
Cable (flat ribbon cable 10 cm with socket connector and male quick connector, AMP 4-pin)		5.03.771.306/0000	5 - 29
Blanking cap complete with sealing disc and ring nut, square		5.05.800.049/0100	2 - 83, 5 - 23
Label holder, flush, for square collar		5.07.620.004/0000	2 - 80
Flat ribbon cable, 4-wire, 1 m long		5.37.700.124/0000	5 - 28
Fixing spanner M 15, M 16		5.58.002.019/0105	5 - 25
Socket connector, 4-pin		5.92.025.368/0000	5 - 28

LUMOTAST 25 Selector switch, ring nut fixing

Technical data see page 1 - 24

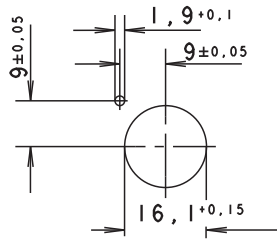
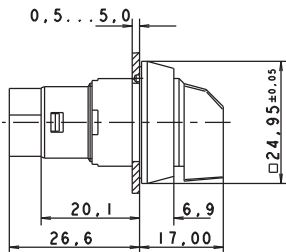

Panel cut-out



→ Contact arrangement	Contact function	Rotating angle	Actuator	Order no.
1 NO	latching	right, 1 x 90°		1.15.153.106/0100

PUSHBUTTONS

LUMOTAST 25 - KEYLOCK SWITCHES

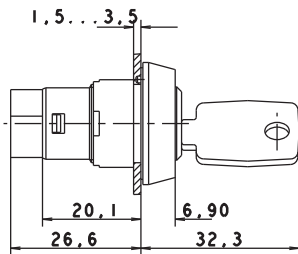

LUMOTAST 25 Keylock switches

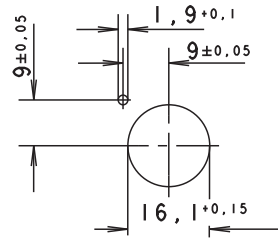

Panel cut-out

→ The locking systems we use are created according to DIN EN 1303 by leading lock manufacturers. They are open, mechanical systems that require occasional maintenance of the machinery or plant operator depending on environmental conditions.

Technical Data

→ General information

Color of lens	black opaque
Form of collar	square

→ Dimensions

Length of collar	25 mm
Width of collar	25 mm
Overall height	32.3 mm
Mounting depth with connector	30.7 mm
Mounting depth with plug-in socket	33.4 mm
Mounting hole	16.2 mm

→ Mechanical design

Mounting	ring nut
Terminals	pin connector 4-pol./ plug-in socket
Contact system	snap-action contact
Contact function	latching
Contact arrangement	1 NO
Contact materials	Au
Illumination	no
Lamp socket	no
Lock	cylinder lock
Wafers	8 pins
Lock type	5201
Number of locking positions	10,000
Main key	yes
Symmetric key	yes
Key removal position	see order block

→ Mechanical characteristics

Operating force max.	1.5 N
Rotating angle	90°

→ Electrical characteristics

Rated voltage AC/DC max.	35 V
Rated voltage AC/DC min.	0.02 V
Rated current AC/DC max.	100 mA
Rated current AC/DC min.	0.01 mA
Contact resistance acc. to life max.	100 mΩ
Bouncing time max.	5 ms

→ Other specifications

Operating life (operations)	50,000
Degree of protection from front side	IP65 (DIN EN 60529)
Operation temperature min.	-25 °C









1

LUMO
25

**– Technical data (continued) –
LUMOTAST 25 - Keylock switch**

Ambient temp. operating max.	+70 °C
Storage temperature min.	-40 °C
Storage temperature max.	+80 °C
Environmental resistance	acc. to IEC 60068-2-14, -30, -33 and -78
Weight	20 g
ROHS compliant	yes
REACH compliant	yes

Accessories LUMOTAST 25 - Keylock switch

→ Description	Photo	Order no.	Additional accessories see page
Plug-in socket for PCB		5.00.645.036/0000	5 - 28
Cable (flat ribbon cable 10 cm with socket connector and male quick connector, AMP 4-pin)		5.03.771.306/0000	5 - 29
Blanking cap complete with sealing disc and ring nut, square		5.05.800.049/0100	2 - 83, 5 - 23
Label holder, flush, for square collar		5.07.620.004/0000	2 - 80
Flat ribbon cable, 4-wire, 1 m long		5.37.700.124/0000	5 - 28
Fixing spanner M 15, M 16		5.58.002.019/0105	5 - 25
Spare key set (2 keys)		5.58.015.201/0000	-
Legend label 23 x 16 for label holder, without legend		5.73.111.000/0000	-
Socket connector, 4-pin		5.92.025.368/0000	5 - 28

PUSHBUTTONS

LUMOTAST 25 - KEYLOCK SWITCHES

1



LUMOTAST 25 Keylock switch

Technical data see page 1 - 26

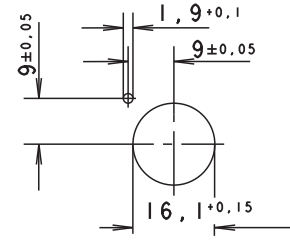
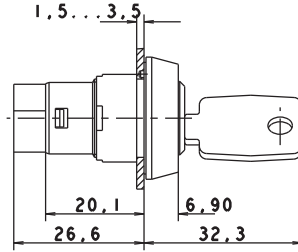

Panel cut-out

→ Contact arrangement	Contact function	Rotating angle	Key removal position	Color of lens	Order no.
1 NO	latching	90°		black opaque	1.15.156.001/0000
1 NO	latching	90°		black opaque	1.15.156.011/0000

Included: 2 keys.

LUMOTAST 25 Emergency stop pushbuttons

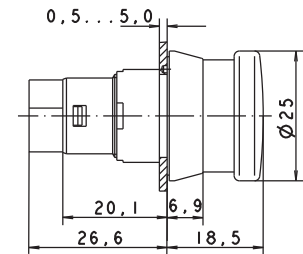
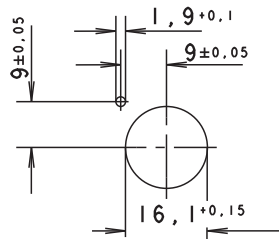

→ Original manual see „Appendix“

Technical Data

→ General information

Color of lens	opaque red
Form of collar	square
Color of collar	see order block

→ Dimensions

Length of collar	25 mm
Width of collar	25 mm
Overall height	18.5 mm
Mounting depth with connector	30.7 mm
Mounting depth with plug-in socket	33.4 mm
Mounting hole	16.2 mm

→ Mechanical design

Mounting	ring nut
Terminals	pin connector 4-pole / plug-in socket
Contact system	snap-action contact
Contact function	latching
Contact arrangement	2 NC (forcibly actuated)
Contact materials	Au
Illumination	no
Reset	by pulling

→ Mechanical characteristics

Operating force max.	10 N
Operating travel	2.6 mm
Switching travel	2 mm
Robustness max.	100 N

→ Electrical characteristics

Rated voltage AC/DC max.	25 V
Rated voltage AC/DC min.	0.02 V
Rated current AC/DC max.	100 mA (1A short-circuit current)
Rated current AC/DC min.	0.01 mA
Contact resistance acc. to life max.	100 mΩ
Bouncing time max.	10 ms

→ Other specifications

Operating life (operations)	15,000
Degree of protection from front side	IP65 (DIN EN 60529)
Operation temperature min.	-25 °C
Ambient temp. operating max.	+70 °C
Storage temperature min.	-40 °C
Storage temperature max.	+80 °C
Environmental resistance	acc. to IEC 60068-2-14, -30, -33 and -78

Approvals















PUSHBUTTONS

LUMOTAST 25 - EMERGENCY STOP PUSHBUTTONS

– Technical data (continued) – LUMOTAST 25 - Emergency stop pushbutton

Weight	9 g
ROHS compliant	yes
REACH compliant	yes

Accessories LUMOTAST 25 - Emergency stop pushbutton

→ Description	Photo	Order no.	Additional accessories see page
Plug-in socket for PCB		5.00.645.036/0000	5 - 28
Cable (flat ribbon cable 10 cm with socket connector and male quick connector, AMP 4-pin)		5.03.771.306/0000	5 - 29
Blanking cap complete with sealing disc and ring nut, square		5.05.800.049/0100	2 - 83, 5 - 23
Label holder, flush, for square collar		5.07.620.004/0000	2 - 80
Flat ribbon cable, 4-wire, 1 m long		5.37.700.124/0000	5 - 28
Fixing spanner M 15, M 16		5.58.002.019/0105	5 - 25
Legend label 23 x 16 for label holder, without legend		5.73.111.000/0000	-
Adhesive label yellow, round 16.1 / 60 mm, without legend		5.76.204.425/0400	-
Adhesive label yellow, round 16.1 / 60 mm, with legend „Not-Aus“		5.76.204.426/0400	-
Adhesive label yellow, round 16.1 / 60 mm, with legend „ARRET-D'URGENCE“		5.76.204.427/0400	-
Adhesive label yellow, round 16.1 / 60 mm, with legend „EMERGENCY-STOP“		5.76.204.428/0400	-
Adhesive label yellow, round 16.1 / 60 mm, with legend „ARRESTO-D'EMERGENZA“		5.76.204.429/0400	-
Socket connector, 4-pin		5.92.025.368/0000	5 - 28

1

LUMO
25

LUMOTAST 25 Emergency stop pushbutton, ring nut fixing

Technical data see page 1 - 29

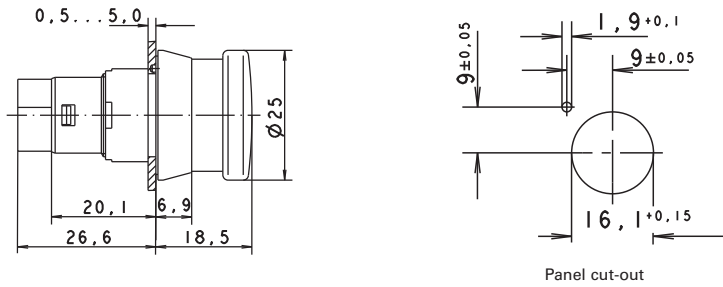

1

LUMO
25

→ Contact function	Contact arrangement	Color of collar	Order no.
latching	2 NC (forcibly actuated)	yellow	1.15.154.016/0301
latching	2 NC (forcibly actuated)	black	1.15.154.006/0301

Original operating instructions see appendix.

PUSHBUTTONS

LUMOTAST 25 - SIGNAL LAMPS

1

LUMO
25



LUMOTAST 25 Signal lamps

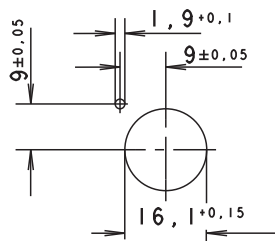

Panel cut-out

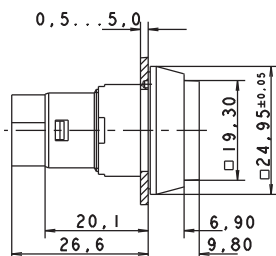

Technical Data

→ General information

Form of lens	square
Color of lens	see order block

→ Dimensions

Length of collar	25 mm
Width of collar	25 mm
Overall height	9.8 mm
Mounting depth with connector	30.7 mm
Mounting depth with plug-in socket	33.4 mm
Mounting hole	16.2 mm

→ Mechanical design

Mounting	see order block
Terminals	pin connector 4-pole / plug-in socket
Lamp socket	Bi-Pin T1 / T1¼
Lamp	filament lamp / LED

→ Electrical characteristics



Voltage limit max.	24 V
Power limit max.	0.7 W

→ Other specifications









Degree of protection from front side	IP65 (DIN EN 60529)
Weight	7 g
Operation temperature min.	-25 °C
Ambient temp. operating max.	+70 °C
Storage temperature min.	-40 °C
Storage temperature max.	+80 °C
Environmental resistance	acc. to IEC 60068-2-14, -30, -33 and -78
ROHS compliant	yes
REACH compliant	yes

Accessories LUMOTAST 25 - Signal lamp

→ Description

Description	Photo	Order no.	Additional accessories see page
Socket Bi-Pin T 1, LED		-	5 - 6
Socket Bi-Pin T 1, LED superbright		-	5 - 6
Plug-in socket for PCB		5.00.645.036/0000	5 - 28

– Table (continued) –
Accessories LUMOTAST 25 - Signal lamp

→ Description	Photo	Order no.	Additional accessories see page
Cable (flat ribbon cable 10 cm with socket connector and male quick connector, AMP 4-pin)		5.03.771.306/0000	5 - 29
Disassembly tool for LUMOTAST 25, RAFIX 16		5.05.800.042/0000	5 - 27
Blanking cap complete with sealing disc and ring nut, square		5.05.800.049/0100	2 - 83, 5 - 23
Label holder, flush, for square collar		5.07.620.004/0000	2 - 80
Flat ribbon cable, 4-wire, 1 m long		5.37.700.124/0000	5 - 28
Fixing spanner M 15, M 16		5.58.002.019/0105	5 - 25
Legend insert, blank, use only for transparent lenses		5.70.635.000/2000	-
Legend label 23 x 16 for label holder, without legend		5.73.111.000/0000	-
Socket connector, 4-pin		5.92.025.368/0000	5 - 28

LUMOTAST 25 Signal lamp, 24 V, „Click“ quick-assembly feature

Technical data see page 1 - 32

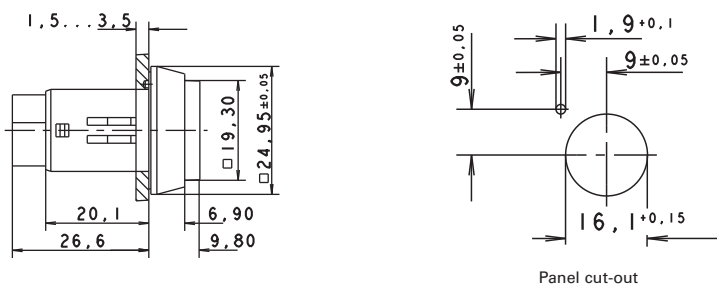

→ Voltage limit max.	Power limit max.	Lamp socket	Order no.	Note
24 V	0.7 W	Bi-Pin T1 / T1¼	1.65.122.906/0000	Please include the desired lens in your order.

Do not press in lens in disassembled condition.
Please note when using a LED: A notch on the lamp identifies the cathode side (-).

Lenses:

- Lens, square, transparent colorless: 5.49.077.014/1002
- Lens, square, transparent red: 5.49.077.014/1306
- Lens, square, transparent yellow: 5.49.077.014/1403
- Lens, square, transparent green: 5.49.077.014/1505
- Lens, square, transparent blue: 5.49.077.014/1607

PUSHBUTTONS

LUMOTAST 25 - SIGNAL LAMPS



LUMOTAST 25 Signal lamp, 24 V, ring nut fixing

Technical data see page 1 - 32

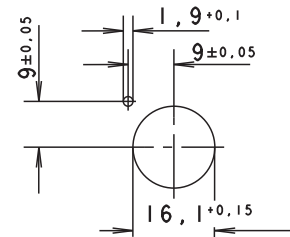
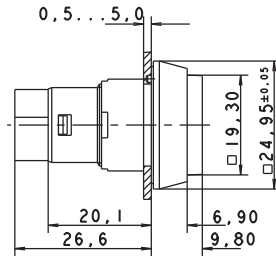

Panel cut-out

→ Voltage limit max.	Power limit max.	Lamp socket	Order no.	Note
24 V	0.7 W	Bi-PinT1 / T1¼	1.65.122.956/0000	Please include the desired lens in your order.

Please note when using LED: A notch on the lamp socket identifies the cathode side (-).

Lenses:

- Lens, square, transparent colorless: 5.49.077.014/1002
- Lens, square, transparent red: 5.49.077.014/1306
- Lens, square, transparent yellow: 5.49.077.014/1403
- Lens, square, transparent green: 5.49.077.014/1505
- Lens, square, transparent blue: 5.49.077.014/1607



LUMOTAST 75 IP40

LUMOTAST 75 IP40 - Pushbutton range

Illuminated pushbuttons, signal lamps and keylock switches

- Mounting hole diameter 16.2 mm
 - Degree of protection IP40 acc. DIN EN 60529
 - Solder terminals for the following wire cross-sections:
 - Installed 0.5 mm² max.
 - Factory terminated 0.35 mm² max.
 - 250 V/4 A max.
 - 2 NC + 2 NO max.
 - Lamp socket T 4.5
 - Illumination: LED / filament lamp
 - All products are RoHS compliant.
-

PUSHBUTTONS

LUMOTAST 75 IP40

Content

LUMOTAST 75 IP40 Illuminated pushbuttons

LUMOTAST 75 IP40 Illuminated pushbutton, protruding lens, round collar	1 - 37
LUMOTAST 75 IP40 Illuminated pushbutton, protruding lens, round collar	1 - 39
LUMOTAST 75 IP40 Illuminated pushbutton, flush lens, square collar	1 - 39
LUMOTAST 75 IP40 Illuminated pushbutton, protruding lens, square collar	1 - 40
LUMOTAST 75 IP40 Illuminated pushbutton, flush lens, rectangular collar	1 - 41

LUMOTAST 75 IP40 Keylock switches

LUMOTAST 75 IP40 Keylock switch, round collar	1 - 42
LUMOTAST 75 IP40 Keylock switch, round collar	1 - 43
LUMOTAST 75 IP40 Keylock switch, rectangular collar	1 - 44

LUMOTAST 75 IP40 Signal lamps with lamp socket T 4.5

LUMOTAST 75 IP40 Signal lamp with lamp socket T 4.5, round collar, protruding lens	1 - 45
LUMOTAST 75 IP40 Signal lamp with lamp socket T 4.5, round collar, protruding lens	1 - 46
LUMOTAST 75 IP40 Signal lamp, square collar, flush lens	1 - 47
LUMOTAST 75 IP40 Signal lamp, square collar, protruding lens	1 - 47
LUMOTAST 75 IP40 Signal lamp, rectangular collar, flush lens	1 - 48

1

LUMO
75 (40)

LUMOTAST 75 IP40 Illuminated pushbuttons

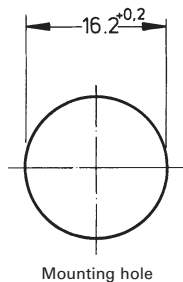

1

LUMO
75 (40)

Technical Data

→ General information

Form of lens	see order block
Form of collar	see order block
Color of collar	see order block

→ Dimensions

Length of collar	see order block
Width of collar	see order block
Diameter of collar	see order block
Overall height	7.5 mm
Mounting depth	41.5/49.5/57.5 mm
Mounting hole	16.2 mm

→ Mechanical design

Mounting	ring nut
Terminals	solder terminals
Contact system	snap-action bridge contact
Contact function	see order block
Contact arrangement	see order block
Contact materials	Ag
Illumination	LED
Lamp socket	T 4.5

→ Mechanical characteristics

Operating force max.	3 ... 6.5 N
Operating travel	2.7 mm
Switching travel NC	1.6 mm
Switching travel NO	0.9 mm
Robustness max.	100 N

→ Electrical characteristics

Rated voltage AC max.	250 V
Rated voltage DC max.	230 V
Rated voltage AC/DC min.	12 V
Rated current AC max.	4 A
Rated current DC max.	0.2 A
Rated current AC/DC min.	5 mA
Contact resistance acc. to life max.	200 mΩ
Protection class	II
ESD-strength min.	14 kV

→ Other specifications

Operating life, at 250 V/2 A (operations)	200,000 (momentary)
Operating life, at 250 V/4 A (operations)	60,000 (momentary), 10,000 (latching)
Degree of protection from front side	IP40 (DIN EN 60529)
Operation temperature min.	-25 °C
Ambient temp. operating max. without lamp /LED	+70 °C

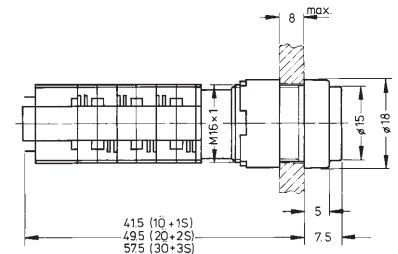

Approvals



ENEC 25T70
without lamp,
25T55 with lamp



UL 508



C22.2
No. 14-M91



PUSHBUTTONS

LUMOTAST 75 IP40 - ILLUMINATED PUSHBUTTONS





1

– Technical data (continued) – LUMOTAST 75 IP40 - Illuminated pushbutton

Ambient temp. operating max. with lamp /LED	+55 °C
Storage temperature min.	-40 °C
Storage temperature max.	+80 °C
Environmental resistance	acc. to IEC 60068-2-14, -30, -33 and -78
Flame class acc. to UL 94	V 1
Hot wire ignition acc. to IEC 60695-2-1	yes
ROHS compliant	yes
REACH compliant	yes

Accessories LUMOTAST 75 IP40 - Illuminated pushbutton

LUMO
75 (40)

→ Description	Photo	Order no.	Additional accessories see page
Socket T 4.5, LED		-	5 - 7
Socket T 4.5, LED superbright		-	5 - 7
Lamp extractor for lamp diameter 4 mm		1.90.900.002/0000	5 - 26
Lamp extractor for lamp diameter 5-6 mm		1.90.900.004/0000	5 - 26
Blanking cap, black, to cover spare holes, dimensions 18 x 18 mm		5.52.006.020/0103	5 - 22
Blanking cap, black, to cover spare holes, dimensions 18 x 24 mm		5.52.006.021/0100	5 - 22
Blanking cap, black, to cover spare holes, round 18 mm		5.52.006.022/0100	5 - 22
Fixing spanner M 15, M 16		5.58.002.019/0105	5 - 25

LUMOTAST 75 IP40 Illuminated pushbutton, protruding lens, round collar

Technical data see page 1 - 37

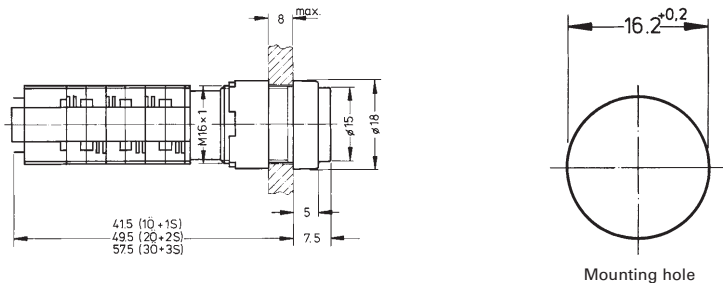

LUMO
75 (40)

→ Contact arrangement	Contact function	Color of collar	Order no.	Note
1 NC + 1 NO	momentary	black	1.15.108.451/0000	Please include the desired lens and diffuser in your order.
1 NC + 1 NO	latching	black	1.15.108.551/0000	Please include the desired lens and diffuser in your order.
2 NC + 2 NO	momentary	black	1.15.108.452/0000	Please include the desired lens and diffuser in your order.
2 NC + 2 NO	latching	black	1.15.108.552/0000	Please include the desired lens and diffuser in your order.

Lenses:

Lens, round, transparent colorless, for LED: 5.49.257.011/1002
 Lens, round, transparent red, for LED: 5.49.257.011/1301
 Lens, round, transparent yellow, for LED: 5.49.257.011/1402
 Lens, round, transparent green, for LED: 5.49.257.011/1503
 Diffuser, round, for LED, without legend: 5.72.050.000/0214

LUMOTAST 75 IP40 Illuminated pushbutton, flush lens, square collar

Technical data see page 1 - 37

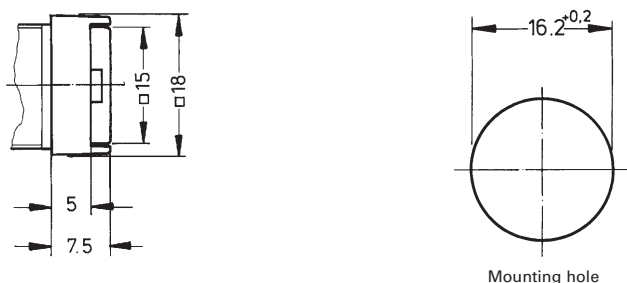

→ Contact arrangement	Contact function	Color of collar	Order no.	Note
1 NC + 1 NO	momentary	black	1.15.108.251/0000	Please include the desired lens and diffuser in your order.
1 NC + 1 NO	latching	black	1.15.108.351/0000	Please include the desired lens and diffuser in your order.

PUSHBUTTONS

LUMOTAST 75 IP40 - ILLUMINATED PUSHBUTTONS

1

– Table (continued) –

LUMOTAST 75 IP40 - Illuminated pushbutton, flush lens, square collar

→ Contact arrangement	Contact function	Color of collar	Order no.	Note
2 NC + 2 NO	momentary	black	1.15.108.252/0000	Please include the desired lens and diffuser in your order.
2 NC + 2 NO	latching	black	1.15.108.352/0000	Please include the desired lens and diffuser in your order.

Lenses:

Lens, square, transparent colorless, for LED: 5.49.275.036/1002

Lens, square, transparent red, for LED: 5.49.275.036/1301

Lens, square, transparent yellow, for LED: 5.49.275.036/1402

Lens, square, transparent green, for LED: 5.49.275.036/1503

Diffuser, square, for LED, without legend: 5.73.013.000/0214

Accessoires:

LUMOTAST 75 IP40 - Protective cap for 18 x 18 collar: 5.05.800.030/0000

LUMOTAST 75 IP40 - Sealing cap for protection class IP 65, for 18 x 18 collar: 5.05.200.009/0000

LUMO
75 (40)



LUMOTAST 75 IP40 Illuminated pushbutton, protruding lens, square collar

Technical data see page 1 - 37

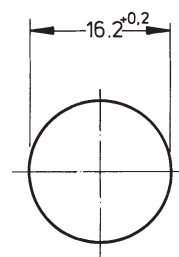
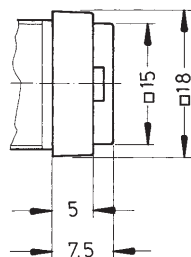

Mounting hole

→ Contact arrangement	Contact function	Color of collar	Order no.	Note
1 NC + 1 NO	momentary	black	1.15.108.256/0000	Please include the desired lens and diffuser in your order.
1 NC + 1 NO	latching	black	1.15.108.356/0000	Please include the desired lens and diffuser in your order.
2 NC + 2 NO	momentary	black	1.15.108.257/0000	Please include the desired lens and diffuser in your order.
2 NC + 2 NO	latching	black	1.15.108.357/0000	Please include the desired lens and diffuser in your order.

Lenses:

Lens, square, transparent colorless, for LED: 5.49.275.036/1002

Lens, square, transparent red, for LED: 5.49.275.036/1301

Lens, square, transparent yellow, for LED: 5.49.275.036/1402

Lens, square, transparent green, for LED: 5.49.275.036/1503

Diffuser, square, for LED, without legend: 5.73.013.000/0214

Accessoires:

LUMOTAST 75 IP40 - Protective cap for 18 x 18 collar: 5.05.800.030/0000

LUMOTAST 75 IP40 - Sealing cap for protection class IP 65, for 18 x 18 collar: 5.05.200.009/0000

LUMOTAST 75 IP40 Illuminated pushbutton, flush lens, rectangular collar

Technical data see page 1 - 37

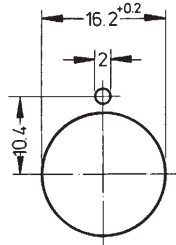
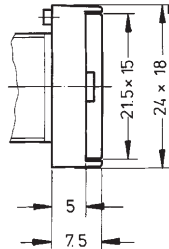

Panel cut-out



1

LUMO
75 (40)

→ Contact arrangement	Contact function	Color of collar	Order no.	Note
1 NC + 1 NO	momentary	black	1.15.108.051/0000	Please include the desired lens and diffuser in your order.
1 NC + 1 NO	latching	black	1.15.108.151/0000	Please include the desired lens and diffuser in your order.
2 NC + 2 NO	momentary	black	1.15.108.052/0000	Please include the desired lens and diffuser in your order.
2 NC + 2 NO	latching	black	1.15.108.152/0000	Please include the desired lens and diffuser in your order.

Lenses:

Lens, rectangular, transparent colorless, for LED: 5.49.275.032/1002

Lens, rectangular, transparent red, for LED: 5.49.275.032/1301

Lens, rectangular, transparent yellow, for LED: 5.49.275.032/1402

Lens, rectangular, transparent green, for LED: 5.49.275.032/1503

Diffuser, rectangular, for LED, without legend: 5.73.012.000/0214

Accessoires:

LUMOTAST 75 IP40 - Protective cap for 18 x 24 collar: 5.05.800.027/0000

LUMOTAST 75 IP40 - Sealing cap for protection class IP65, for 18 x 24 collar: 5.05.200.008/0000



LUMOTAST 75 IP40 Keylock switches

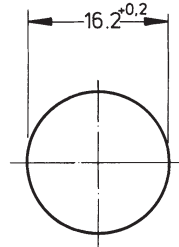

Mounting hole

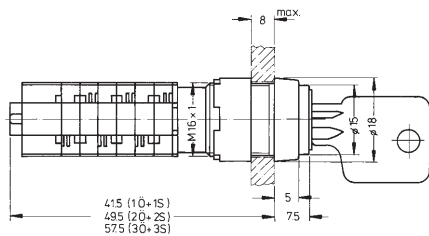

→ The locking systems we use are created according to DIN EN 1303 by leading lock manufacturers. They are open, mechanical systems that require occasional maintenance of the machinery or plant operator depending on environmental conditions.

Technical Data

→ General information

Form of lens	see order block
Color of collar	see order block
Form of collar	see order block

→ Dimensions

Length of collar	see order block
Diameter of collar	see order block
Width of collar	see order block
Overall height (without key)	7.5 mm
Mounting depth	see order block
Mounting hole	16.2 mm

→ Mechanical design

Mounting	ring nut
Terminals	solder terminals
Contact system	snap-action bridge contact
Contact function	see order block
Contact arrangement	see order block
Contact materials	Ag
Illumination	no
Lock	cylinder lock
Wafers	4 pins
Lock type	1D 21
Number of locking positions	45
Main key	no
Symmetric key	no
Key removal position	see order block

→ Mechanical characteristics

Rotating angle	see order block
----------------	-----------------

→ Electrical characteristics

Rated voltage AC max.	250 V
Rated voltage DC max.	230 V
Rated voltage AC/DC min.	12 V
Rated current AC max.	4 A
Rated current DC max.	0,2 A
Rated current AC/DC min.	5 mA
Contact resistance acc. to life max.	200 mΩ
ESD-strength min.	14 kV

→ Other specifications

Operating life, at 250 V/2 A (operations)	50,000 (momentary)
Operating life, at 250 V/4 A (operations)	50,000 (momentary)
Degree of protection from front side	IP40 (DIN EN 60529)

Approvals



ENEC 25T70



UL 508







C22.2
No. 14-M91



**- Technical data (continued) -
LUMOTAST 75 IP40 - Keylock switch**

Operation temperature min.	-25 °C
Ambient temp. operating max.	+70 °C
Storage temperature min.	-40 °C
Storage temperature max.	+80 °C
Environmental resistance	acc. to IEC 60068-2-14, -30, -33 and -78
Weight	35 g
Flame class acc. to UL 94	V 1
Hot wire ignition acc. to IEC 60695-2-1	yes
ROHS compliant	yes
REACH compliant	yes

Accessories LUMOTAST 75 IP40 - Keylock switch

→ Description	Photo	Order no.	Additional accessories see page
Blanking cap, black, to cover spare holes, dimensions 18 x 24 mm		5.52.006.021/0100	5 - 22
Blanking cap, black, to cover spare holes, round 18 mm		5.52.006.022/0100	5 - 22
Fixing spanner M 15, M 16		5.58.002.019/0105	5 - 25
Keylock switch cap		5.58.002.030/0000	-
LUMOTAST 75 - Spare key (1 piece)		5.58.004.721/0000	-

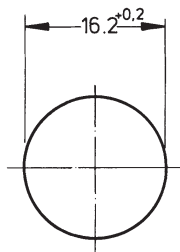
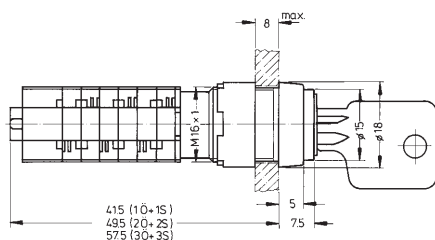

LUMOTAST 75 IP40 Keylock switch, round collar

Technical data see page 1 - 42



Mounting hole





→ Contact arrangement	Contact function	Rotating angle	Key removal position	Color of collar	Order no.
1 NC + 1 NO	momentary	45°		black	1.15.108.941/0000
1 NC + 1 NO	latching	90°		black	1.15.108.851/0000

PUSHBUTTONS

LUMOTAST 75 IP40 - KEYLOCK SWITCHES

1

– Table (continued) –
LUMOTAST 75 IP40 - Keylock switch, round collar

→ Contact arrangement	Contact function	Rotating angle		Key removal position	Color of collar	Order no.
1 NC + 1 NO	latching	90°		0+1	black	1.15.108.911/0000
2 NC + 2 NO	latching	90°		0	black	1.15.108.852/0000
2 NC + 2 NO	latching	90°		0+1	black	1.15.108.912/0000

Included: 2 keys.

Other lock variants and contact arrangements available on request.

LUMO
75 (40)





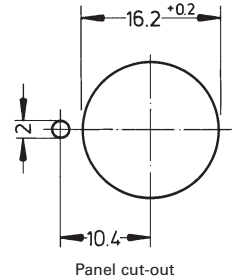
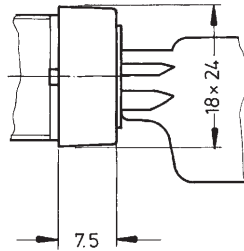

LUMOTAST 75 IP40 Keylock switch, rectangular collar

Technical data see page 1 - 42



Panel cut-out

→ Contact arrangement	Contact function	Rotating angle		Key removal position	Color of collar	Order no.
1 NC + 1 NO	momentary	45°		0	black	1.15.108.661/0100
1 NC + 1 NO	latching	90°		0	black	1.15.108.571/0100
1 NC + 1 NO	latching	90°		0+1	black	1.15.108.631/0100
2 NC + 2 NO	latching	90°		0	black	1.15.108.572/0100
2 NC + 2 NO	latching	90°		0+1	black	1.15.108.632/0100

Included: 2 keys.

Other lock variants and contact arrangements available on request.

LUMOTAST 75 IP40 Signal lamps with lamp socket T 4.5

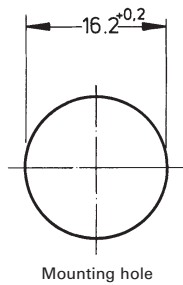

1

LUMO
75 (40)

Technical Data

→ General information

Form of lens	see order block
Form of collar	see order block
Color of collar	see order block

→ Dimensions

Length of collar	see order block
Width of collar	see order block
Diameter of collar	see order block
Overall height	7.5 mm
Mounting depth	33.5 mm
Mounting hole	16.2 mm

→ Mechanical design

Mounting	ring nut
Terminals	solder terminals
Lamp socket	T 4.5
Illumination	LED / filament lamp

→ Electrical characteristics

Voltage limit max.	35 V
Power limit max.	1.2 W

→ Other specifications

Degree of protection from front side	IP40 (DIN EN 60529)
Weight	5 g
Operation temperature min.	-25 °C
Ambient temp. operating max.	+55 °C
Storage temperature min.	-40 °C
Storage temperature max.	+80 °C
Environmental resistance	acc. to IEC 60068-2-14, -30, -33 and -78
ROHS compliant	yes
REACH compliant	yes

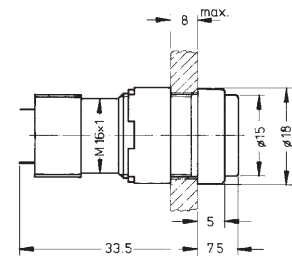

Approvals



IEC 61058



UL 508



C22.2
No. 14-M91



Accessories LUMOTAST 75 IP40 - Signal lamp with lamp socket T 4.5

Description	Photo	Order no.	Additional accessories see page
Socket T 4.5, LED		-	5 - 7
Socket T 4.5, LED superbright		-	5 - 7





PUSHBUTTONS

LUMOTAST 75 IP40 - SIGNAL LAMPS WITH LAMP SOCKET T 4.5

1

– Table (continued) –

Accessories LUMOTAST 75 IP40 - Signal lamp with lamp socket T 4.5

→ Description	Photo	Order no.	Additional accessories see page
Blanking cap, black, to cover spare holes, dimensions 18 x 18 mm		5.52.006.020/0103	5 - 22
Blanking cap, black, to cover spare holes, dimensions 18 x 24 mm		5.52.006.021/0100	5 - 22
Blanking cap, black, to cover spare holes, round 18 mm		5.52.006.022/0100	5 - 22
Fixing spanner M 15, M 16		5.58.002.019/0105	5 - 25

LUMO
75 (40)



LUMOTAST 75 IP40 Signal lamp with lamp socket T 4.5, round collar, protruding lens

Technical data see page 1 - 45

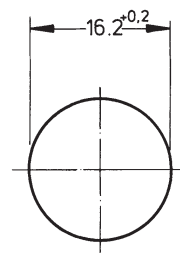
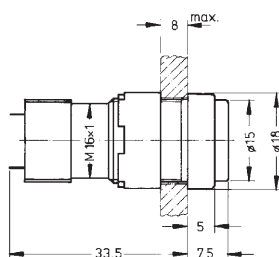

Mounting hole

→ Voltage limit max.	Power limit max.	Lamp socket	Color of collar	Order no.	Note
35 V	1.2 W	T 4.5	black	1.65.111.071/0000	Please include the desired lens and diffuser in your order.

Lenses:

Lens, round, transparent colorless, for LED: 5.49.257.011/1002

Lens, round, transparent red, for LED: 5.49.257.011/1301

Lens, round, transparent yellow, for LED: 5.49.257.011/1402

Lens, round, transparent green, for LED: 5.49.257.011/1503

Diffuser, round, for LED, without legend: 5.72.050.000/0214

LUMOTAST 75 IP40 Signal lamp, square collar, flush lens

Technical data see page 1 - 45

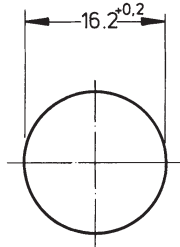
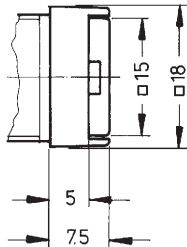

Mounting hole



1

→ Voltage limit max.	Power limit max.	Lamp socket	Color of collar	Order no.	Note
35 V	1.2 W	T 4.5	black	1.65.111.061/0000	Please include the desired lens and diffuser in your order.

LUMO
75 (40)

Lenses:

Lens, square, transparent colorless, for LED: 5.49.275.036/1002

Lens, square, transparent red, for LED: 5.49.275.036/1301

Lens, square, transparent yellow, for LED: 5.49.275.036/1402

Lens, square, transparent green, for LED: 5.49.275.036/1503

Diffuser, square, for LED, without legend: 5.73.013.000/0214

LUMOTAST 75 IP40 Signal lamp, square collar, protruding lens

Technical data see page 1 - 45

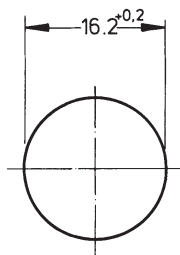
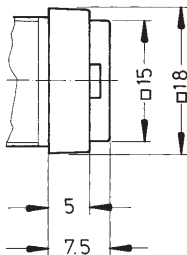

Mounting hole



→ Voltage limit max.	Power limit max.	Lamp socket	Color of collar	Order no.	Note
35 V	1.2 W	T 4.5	black	1.65.111.081/0000	Please include the desired lens and diffuser in your order.

Lenses:

Lens, square, transparent colorless, for LED: 5.49.275.036/1002

Lens, square, transparent red, for LED: 5.49.275.036/1301

Lens, square, transparent yellow, for LED: 5.49.275.036/1402

Lens, square, transparent green, for LED: 5.49.275.036/1503

PUSHBUTTONS

LUMOTAST 75 IP40 - SIGNAL LAMPS WITH LAMP SOCKET T 4.5

1

– Table (continued) –

LUMOTAST 75 IP40 - Signal lamp, square collar, protruding lens

Diffuser, square, for LED, without legend: 5.73.013.000/0214

Accessoires:

LUMOTAST 75 IP40 - Sealing cap for protection class IP 65, for 18 x 18 collar: 5.05.200.009/0000



LUMOTAST 75 IP40 Signal lamp, rectangular collar, flush lens

Technical data see page 1 - 45

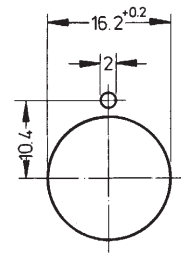
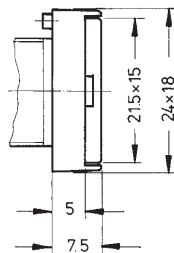

Panel cut-out

LUMO
75 (40)

→ Voltage limit max.	Power limit max.	Lamp socket	Color of collar	Order no.	Note
35 V	1.2 W	T 4.5	black	1.65.111.051/0000	Please include the desired lens and diffuser in your order.

Lenses:

Lens, rectangular, transparent colorless, for LED: 5.49.275.032/1002

Lens, rectangular, transparent red, for LED: 5.49.275.032/1301

Lens, rectangular, transparent yellow, for LED: 5.49.275.032/1402

Lens, rectangular, transparent green, for LED: 5.49.275.032/1503

Diffuser, rectangular, for LED, without legend: 5.73.012.000/0214

Accessoires:

LUMOTAST 75 IP40 -Sealing cap for protection class IP65, for 18 x 24 collar: 5.05.200.008/0000



LUMOTAST 75 IP65

LUMOTAST 75 IP65 - Pushbutton range

Illuminated pushbuttons and signal lamps with lamp socket T 4.5

- Mounting hole diameter 16.2 mm
 - Degree of protection IP65 acc. to DIN EN 60529
 - Solder terminals for the following wire cross-sections:
 - Installed 0.5 mm² max.
 - Factory terminated 0.35 mm² max.
 - 250 V/4 A max.
 - 2 NC + 2 NO max.
 - Illumination: LED / filament lamp
 - All products are RoHS compliant.
-

PUSHBUTTONS

LUMOTAST 75 IP65

1

Content

LUMOTAST 75 IP65 Illuminated pushbuttons

LUMOTAST 75 IP65 Illuminated pushbutton, flush lens, round collar	1 - 51
LUMOTAST 75 IP65 Illuminated pushbutton, protruding lens, round collar	1 - 53
LUMOTAST 75 IP65 Illuminated pushbutton, protruding lens, round collar	1 - 53
LUMOTAST 75 IP65 Illuminated pushbutton, flush lens, square collar	1 - 54
LUMOTAST 75 IP65 Illuminated pushbutton, protruding lens, square collar	1 - 55
LUMOTAST 75 IP65 Illuminated pushbutton, flush lens, rectangular collar	1 - 55

LUMOTAST 75 IP65 Signal lamps

LUMOTAST 75 IP65 Signal lamp, flush lens, round collar	1 - 57
LUMOTAST 75 IP65 Signal lamp, flush lens, round collar	1 - 58
LUMOTAST 75 IP65 Signal lamp, protruding lens, round collar	1 - 59
LUMOTAST 75 IP65 Signal lamp, flush lens, rectangular collar	1 - 59
LUMOTAST 75 IP65 Signal lamp, protruding lens, square collar	1 - 60
LUMOTAST 75 IP65 Signal lamp, flush lens, square collar	1 - 61

LUMO
75 (65)

LUMOTAST 75 IP65 Illuminated pushbuttons

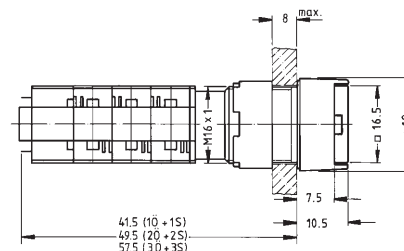
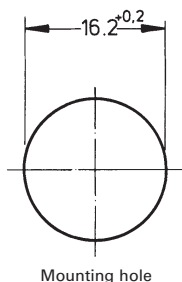

Technical Data

→ General information

Form of lens	see order block
Color of lens	see order block
Form of collar	see order block
Color of collar	black

→ Dimensions

Length of collar	see order block
Diameter of collar	see order block
Width of collar	see order block
Overall height	10.5 mm
Mounting depth	see order block
Mounting hole	16.2 mm

→ Mechanical design

Mounting	ring nut
Terminals	solder terminals
Contact system	snap-action bridge contact
Contact function	see order block
Contact arrangement	see order block
Contact materials	Ag
Illumination	LED / filament lamp
Lamp socket	T 4.5

→ Mechanical characteristics

Operating force	3 ... 6.5 N
Operating travel	2.5 mm
Switching travel NC	1.8 mm
Switching travel NO	0.9 mm
Robustness max.	100 N

→ Electrical characteristics

Rated voltage AC max.	250 V
Rated voltage DC max.	230 V
Rated voltage AC/DC min.	12 V
Rated current AC max.	4 A
Rated current DC max.	0.2 A
Rated current AC/DC min.	5 mA
Contact resistance acc. to life max.	200 mΩ
Protection class	II
ESD-strength min.	14 kV

→ Other specifications

Operating life, at 250 V/2 A (operations)	200,000 (momentary), 50,000 (latching)
Operating life, at 250 V/4 A (operations)	60,000 (momentary)
Degree of protection from front side	IP65 (DIN EN 60529)
Operation temperature min.	-25 °C

Approvals



ENEC 25T70
without lamp,
25T55 with lamp



UL 508



C22.2
No. 14-M91



PUSHBUTTONS

LUMOTAST 75 IP65 - ILLUMINATED PUSHBUTTONS









1

– Technical data (continued) – LUMOTAST 75 IP65 - Illuminated pushbutton

Ambient temp. operating max. without lamp /LED	+70 °C
Ambient temp. operating max. with lamp /LED	+55 °C
Storage temperature min.	-40 °C
Storage temperature max.	+80 °C
Environmental resistance	acc. to IEC 60068-2-14, -30, -33 and -78
Weight	15 g
Flame class acc. to UL 94	V 0
Hot wire ignition acc. to IEC 60695-2-1	yes
ROHS compliant	yes
REACH compliant	yes

Accessories LUMOTAST 75 IP65 - Illuminated pushbutton

LUMO
75 (65)

→ Description	Photo	Order no.	Additional accessories see page
Socket T 4.5, LED		-	5 - 7
Socket T 4.5, LED superbright		-	5 - 7
Lamp extractor for lamp diameter 4 mm		1.90.900.002/0000	5 - 26
Lamp extractor for lamp diameter 5-6 mm		1.90.900.004/0000	5 - 26
Blanking cap, black, to cover spare holes, dimensions 18 x 18 mm		5.52.006.020/0103	5 - 22
Blanking cap, black, to cover spare holes, dimensions 18 x 24 mm		5.52.006.021/0100	5 - 22
Blanking cap, black, to cover spare holes, round 18 mm		5.52.006.022/0100	5 - 22
Fixing spanner M 15, M 16		5.58.002.019/0105	5 - 25

LUMOTAST 75 IP65 Illuminated pushbutton, flush lens, round collar

Technical data see page 1 - 51

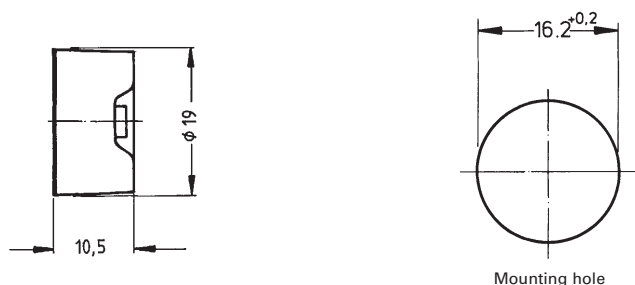

1

→ Contact arrangement	Contact function	Color of collar	Order no.	Note
1 NC + 1 NO	momentary	black	1.15.108.481/0000	Please include the desired lens in your order.
1 NC + 1 NO	latching	black	1.15.108.981/0000	Please include the desired lens in your order.
2 NC + 2 NO	momentary	black	1.15.108.482/0000	Please include the desired lens in your order.
2 NC + 2 NO	latching	black	1.15.108.982/0000	Please include the desired lens in your order.

LUMO
75 (65)

Lenses:

Lens, round, transparent colorless, for LED: 5.49.259.013/1002

Lens, round, transparent red, for LED: 5.49.259.013/1301

Lens, round, transparent yellow, for LED: 5.49.259.013/1402

Lens, round, transparent green, for LED: 5.49.259.013/1503

Accessoires:

Legend insert, round, without legend: 5.70.059.000/2000

LUMOTAST 75 IP65 Illuminated pushbutton, protruding lens, round collar

Technical data see page 1 - 51

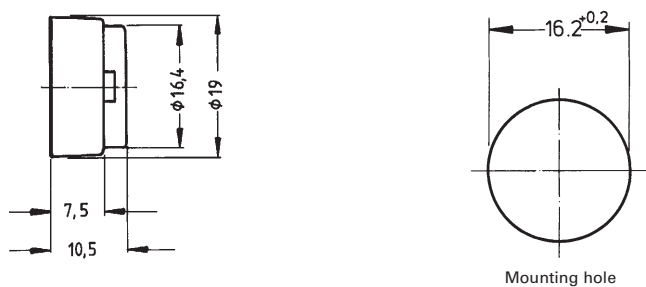

→ Contact arrangement	Contact function	Color of collar	Order no.	Note
1 NC + 1 NO	momentary	black	1.15.108.476/0000	Please include the desired lens in your order.

PUSHBUTTONS

LUMOTAST 75 IP65 - ILLUMINATED PUSHBUTTONS

1

– Table (continued) –

LUMOTAST 75 IP65 - Illuminated pushbutton, protruding lens, round collar

→ Contact arrangement	Contact function	Color of collar	Order no.	Note
1 NC + 1 NO	latching	black	1.15.108.976/0000	Please include the desired lens in your order.
2 NC + 2 NO	momentary	black	1.15.108.477/0000	Please include the desired lens in your order.
2 NC + 2 NO	latching	black	1.15.108.977/0000	Please include the desired lens in your order.

Lenses:

Lens, round, transparent colorless, for LED: 5.49.259.013/1002

Lens, round, transparent red, for LED: 5.49.259.013/1301

Lens, round, transparent yellow, for LED: 5.49.259.013/1402

Lens, round, transparent green, for LED: 5.49.259.013/1503

Accessoires:

Legend insert, round, without legend: 5.70.059.000/2000

LUMO
75 (65)



LUMOTAST 75 IP65 Illuminated pushbutton, flush lens, square collar

Technical data see page 1 - 51

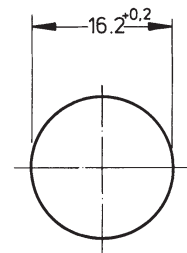
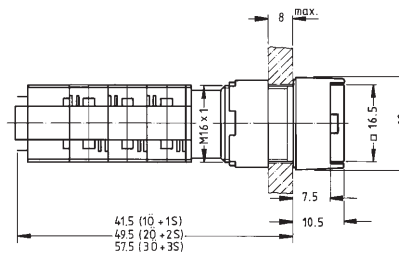

Mounting hole

→ Contact arrangement	Contact function	Color of collar	Order no.	Note
1 NC + 1 NO	momentary	black	1.15.108.276/0000	Please include the desired lens in your order.
1 NC + 1 NO	latching	black	1.15.108.376/0000	Please include the desired lens in your order.
2 NC + 2 NO	momentary	black	1.15.108.277/0000	Please include the desired lens in your order.
2 NC + 2 NO	latching	black	1.15.108.377/0000	Please include the desired lens in your order.

Lenses:

Lens, square, transparent colorless, for LED: 5.49.277.052/1002

Lens, square, transparent red, for LED: 5.49.277.052/1301

Lens, square, transparent yellow, for LED: 5.49.277.052/1402

Lens, square, transparent green, for LED: 5.49.277.052/1503

Accessoires:

Legend insert, square, without legend: 5.70.629.000/2000

LUMOTAST 75 IP65 Illuminated pushbutton, protruding lens, square collar

Technical data see page 1 - 51

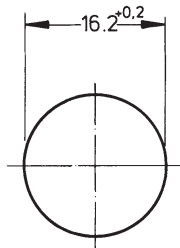
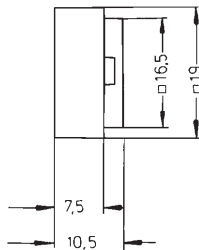

Mounting hole



1

→ Contact arrangement	Contact function	Color of collar	Order no.	Note
1 NC + 1 NO	momentary	black	1.15.108.281/0000	Please include the desired lens in your order.
1 NC + 1 NO	latching	black	1.15.108.381/0000	Please include the desired lens in your order.
2 NC + 2 NO	momentary	black	1.15.108.282/0000	Please include the desired lens in your order.
2 NC + 2 NO	latching	black	1.15.108.382/0000	Please include the desired lens in your order.

LUMO
75 (65)

Lenses:

Lens, square, transparent colorless, for LED: 5.49.277.052/1002

Lens, square, transparent red, for LED: 5.49.277.052/1301

Lens, square, transparent yellow, for LED: 5.49.277.052/1402

Lens, square, transparent green, for LED: 5.49.277.052/1503

Accessoires:

Legend insert, square, without legend: 5.70.629.000/2000

LUMOTAST 75 IP65 Illuminated pushbutton, flush lens, rectangular collar

Technical data see page 1 - 51

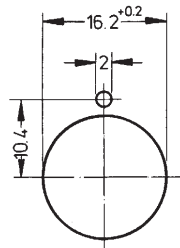
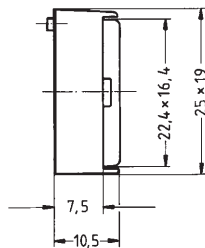

Panel cut-out



→ Contact arrangement	Contact function	Color of collar	Order no.	Note
1 NC + 1 NO	momentary	black	1.15.108.076/0000	Please include the desired lens in your order.

PUSHBUTTONS

LUMOTAST 75 IP65 - ILLUMINATED PUSHBUTTONS

1

– Table (continued) –

LUMOTAST 75 IP65 - Illuminated pushbutton, flush lens, rectangular collar

→ Contact arrangement	Contact function	Color of collar	Order no.	Note
1 NC + 1 NO	latching	black	1.15.108.176/0000	Please include the desired lens in your order.
2 NC + 2 NO	momentary	black	1.15.108.077/0000	Please include the desired lens in your order.
2 NC + 2 NO	latching	black	1.15.108.177/0000	Please include the desired lens in your order.

Lenses:

Lens, rectangular, transparent colorless, for LED: 5.49.277.058/1002

Lens, rectangular, transparent red, for LED: 5.49.277.058/1301

Lens, rectangular, transparent yellow, for LED: 5.49.277.058/1402

Lens, rectangular, transparent green, for LED: 5.49.277.058/1503

Accessoires:

Legend insert, rectangular without legend: 5.70.630.000/2000

LUMO
75 (65)

LUMOTAST 75 IP65 Signal lamps

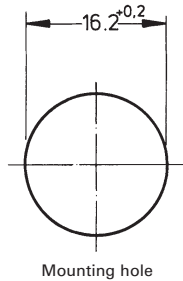

1

Technical Data

→ General information	
Form of lens	see order block
Form of collar	see order block
Diameter of collar	see order block
→ Dimensions	
Length of collar	see order block
Width of collar	see order block
Overall height	10.5 mm
Mounting depth	33.5 mm
Mounting hole	16.2 mm
→ Mechanical design	
Mounting	ring nut
Terminals	solder terminals
Lamp socket	T 4.5
Lamp	LED / filament lamp
→ Electrical characteristics	
Voltage limit max.	35 V
Power limit max.	1.2 W
→ Other specifications	
Degree of protection from front side	IP65 (DIN EN 60529)
Weight	5 g
Operation temperature min.	-25 °C
Ambient temp. operating max.	+55 °C
Storage temperature min.	-40 °C
Storage temperature max.	+80 °C
Environmental resistance	acc. to IEC 60068-2-14, -30, -33 and -78
ROHS compliant	yes
REACH compliant	yes

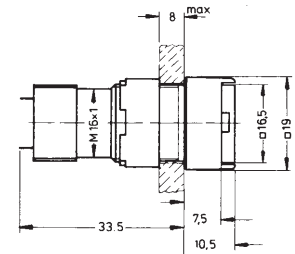

LUMO
75 (65)

Approvals



IEC 61058



UL 508



C22.2 No.
14-M91



Accessories LUMOTAST 75 IP65 - Signal lamp





Description	Photo	Order no.	Additional accessories see page
Socket T 4.5, LED		-	5 - 7
Socket T 4.5, LED superbright		-	5 - 7
Lamp extractor for lamp diameter 4 mm		1.90.900.002/0000	5 - 26

PUSHBUTTONS

LUMOTAST 75 IP65 - SIGNAL LAMPS

1

– Table (continued) –
Accessories LUMOTAST 75 IP65 - Signal lamp

→ Description	Photo	Order no.	Additional accessories see page
Lamp extractor for lamp diameter 5-6 mm		1.90.900.004/0000	5 - 26
Blanking cap, black, to cover spare holes, dimensions 18 x 18 mm		5.52.006.020/0103	5 - 22
Blanking cap, black, to cover spare holes, dimensions 18 x 24 mm		5.52.006.021/0100	5 - 22
Blanking cap, black, to cover spare holes, round 18 mm		5.52.006.022/0100	5 - 22
Fixing spanner M 15, M 16		5.58.002.019/0105	5 - 25

LUMO
75 (65)



LUMOTAST 75 IP65 Signal lamp, flush lens, round collar

Technical data see page 1 - 57

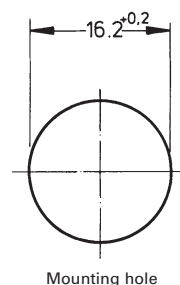
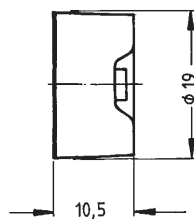

Mounting hole

→ Voltage limit max.	Power limit max.	Lamp socket	Form of collar	Order no.	Note
35 V	1.2 W	T 4.5	round	1.65.111.096/0000	Please include the desired lens in your order.

For assembly, press the lens as far as possible.

Lenses:

- Lens, round, transparent colorless, for LED: 5.49.259.013/1002
- Lens, round, transparent red, for LED: 5.49.259.013/1301
- Lens, round, transparent yellow, for LED: 5.49.259.013/1402
- Lens, round, transparent green, for LED: 5.49.259.013/1503

Accessoires:

- Legend insert, round, without legend: 5.70.059.000/2000

LUMOTAST 75 IP65

Signal lamp, protruding lens, round collar

Technical data see page 1 - 57

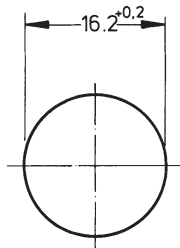
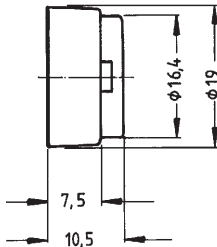

Mounting hole



1

→ Voltage limit max.	Power limit max.	Lamp socket	Form of collar	Order no.	Note
35 V	1.2 W	T 4.5	round	1.65.111.076/0000	Please include the desired lens in your order.

LUMO
75 (65)

For assembly, press the lens as far as possible.

Lenses:

Lens, round, transparent colorless, for LED: 5.49.259.013/1002

Lens, round, transparent red, for LED: 5.49.259.013/1301

Lens, round, transparent yellow, for LED: 5.49.259.013/1402

Lens, round, transparent green, for LED: 5.49.259.013/1503

Accessoires:

Legend insert, round, without legend: 5.70.059.000/2000

LUMOTAST 75 IP65

Signal lamp, flush lens, rectangular collar

Technical data see page 1 - 57

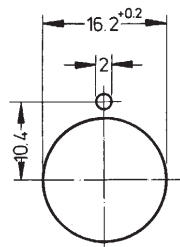
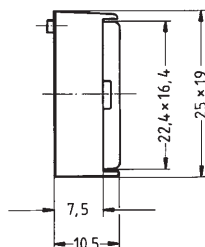

Panel cut-out



→ Voltage limit max.	Power limit max.	Lamp socket	Form of collar	Order no.	Note
35 V	1.2 W	T 4.5	rectangular	1.65.111.056/0000	Please include the desired lens in your order.

For assembly, press the lens as far as possible.

PUSHBUTTONS

LUMOTAST 75 IP65 - SIGNAL LAMPS

1

– Table (continued) –

LUMOTAST 75 IP65 - Signal lamp, flush lens, rectangular collar

Lenses:

Lens, rectangular, transparent colorless, for LED: 5.49.277.058/1002

Lens, rectangular, transparent red, for LED: 5.49.277.058/1301

Lens, rectangular, transparent yellow, for LED: 5.49.277.058/1402

Lens, rectangular, transparent green, for LED: 5.49.277.058/1503

Accessoires:

Legend insert, rectangular without legend: 5.70.630.000/2000



LUMOTAST 75 IP65 Signal lamp, protruding lens, square collar

Technical data see page 1 - 57

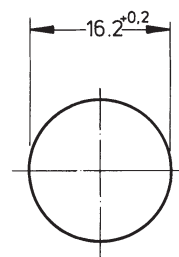
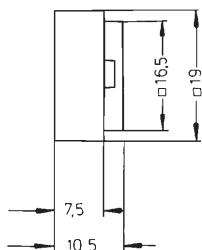

Mounting hole

LUMO
75 (65)

→ Voltage limit max.	Power limit max.	Lamp socket	Form of collar	Order no.	Note
35 V	1.2 W	T 4.5	square	1.65.111.086/0000	Please include the desired lens in your order.

For assembly, press the lens as far as possible.

Lenses:

Lens, square, transparent colorless, for LED: 5.49.277.052/1002

Lens, square, transparent red, for LED: 5.49.277.052/1301

Lens, square, transparent yellow, for LED: 5.49.277.052/1402

Lens, square, transparent green, for LED: 5.49.277.052/1503

Accessoires:

Legend insert, square, without legend: 5.70.629.000/2000

LUMOTAST 75 IP65

Signal lamp, flush lens, square collar

Technical data see page 1 - 57

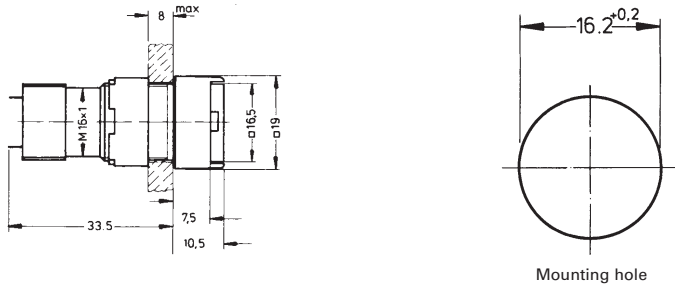

1

→ Voltage limit max.	Power limit max.	Lamp socket	Form of collar	Order no.	Note
35 V	1.2 W	T 4.5	square	1.65.111.066/0000	Please include the desired lens in your order.

LUMO
75 (65)

For assembly, press the lens as far as possible.

Lenses:

- Lens, square, transparent colorless, for LED: 5.49.277.052/1002
- Lens, square, transparent red, for LED: 5.49.277.052/1301
- Lens, square, transparent yellow, for LED: 5.49.277.052/1402
- Lens, square, transparent green, for LED: 5.49.277.052/1503

Accessoires:

- Legend insert, square, without legend: 5.70.629.000/2000



Other keylock switches

Keylock switch for a mounting hole diameter of 16.2 mm

- 35 V max.
 - 100 mA
 - Design matches with LUMOTAST FK and LUMOTAST 75 IP40.
 - All products are RoHS compliant.
-

PUSHBUTTONS

OTHER KEYLOCK SWITCHES

1

Content

Keylock switches

Keylock switch round collar

Keylock switch rectangular collar

1 - 65

1 - 66

1 - 67

Priority keylock switches

Priority keylock switch round collar

Priority keylock switch rectangular collar

Keylock switch PCB plug-in socket

1 - 68

1 - 69

1 - 70

1 - 71

Key
Swit-
ches

KEYLOCK SWITCHES

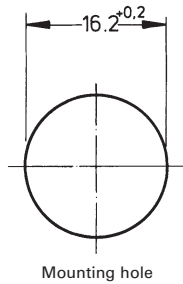

→ The locking systems we use are created according to DIN EN 1303 by leading lock manufacturers. They are open, mechanical systems that require occasional maintenance of the machinery or plant operator depending on environmental conditions.

Technical Data

→ General information	
Form of collar	see order block
→ Dimensions	
Length of collar	see order block
Diameter of collar	see order block
Width of collar	see order block
Overall height	7.5 mm
Mounting depth	39.5 mm; with plug-in socket 41.25 mm
Mounting hole	16.2 mm
→ Mechanical design	
Mounting	ring nut
Terminals	solder terminals
Contact system	sliding contact, self cleaning
Contact function	latching
Contact arrangement	1 NO at every switching position
Contact materials	Au alloy
Illumination	no
→ Mechanical design of lock	
Lock	cylinder lock with pin tumblers
Wafers	5 pins
Lock type	5001
Number of locking positions	10,000
Main key	on request
Symmetric key	on request
Key removal position	see order block
→ Mechanical characteristics	
Operating force min.	0.035 Nm
Operating force max.	1.8 Nm
→ Electrical characteristics	
Rated voltage AC/DC max.	35 V
Rated voltage AC/DC min.	5 V
Rated current AC/DC max.	100 mA
Rated current AC/DC min.	5 mA
ESD strength max.	12 kV
Insulation resistance	$6 \times 10^8 \Omega$
Contact resistance max.	200 m Ω
→ Other specifications	
Operating life (operations)	50,000
Degree of protection from front side	IP65 (DIN EN 60529)
Operation temperature min.	-25 °C
Ambient temp. operating max.	+70 °C
Storage temperature min.	-40 °C
Storage temperature max.	+80 °C

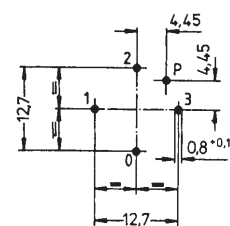
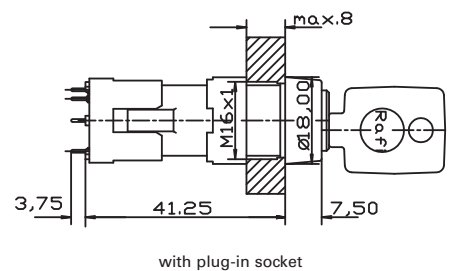
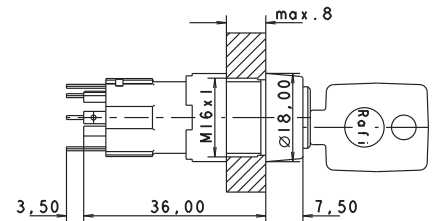

PCB hole pattern, sight on component side

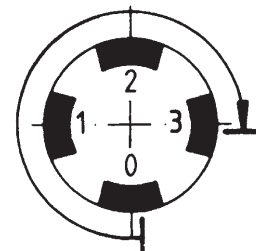

PUSHBUTTONS



KEYLOCK SWITCHES

1

– Technical data (continued) – Keylock switch

Environmental resistance	acc. to IEC 60068-2-14, -30, -33 and -78
Soldering temperature max.	350 °C
Soldering time max.	3 s
Weight	29 g
Rotating angle	see order block
ROHS compliant	yes
REACH compliant	yes

Accessories Keylock switch

→ Description	Photo	Order no.	Additional accessories see page
Plug-in socket for PCB mounting		5.05.510.298/0000	1 - 71
Fixing spanner M 15, M 16		5.58.002.019/0105	5 - 25
Spare key (1 piece)		5.58.011.001/0000	-

Key
Switches





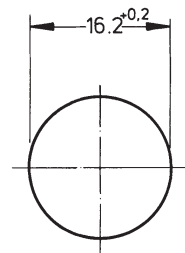
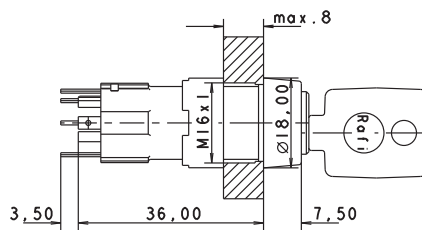

Keylock switch round collar

Technical data see page 1 - 65



Mounting hole

→ Contact arrangement	Contact function	Rotating angle		Key removal position	Order no.
1 NO at every switching position	latching	1 x 90°		0+1	1.10.118.612/0000
1 NO at every switching position	latching	3 x 90°		0+1+2+3	1.10.118.814/0000
1 NO at every switching position	latching	2 x 90°		0	1.10.118.513/0000
1 NO at every switching position	latching	2 x 90°		0+1+2	1.10.118.713/0000

Included: 2 keys.

Keylock switch rectangular collar

Technical data see page 1 - 65

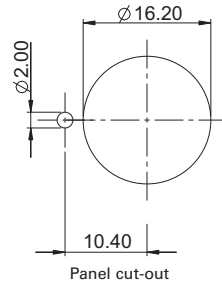
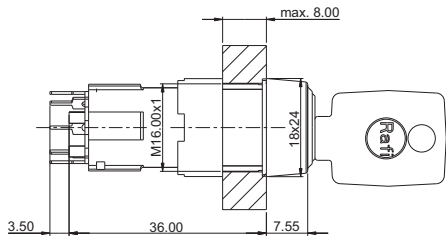

→ Contact arrangement	Contact function	Rotating angle		Key removal position	Order no.
1 NO at every switching position	latching	1 x 90°		0+1	1.10.118.212/0000
1 NO at every switching position	latching	3 x 90°		0+1+2+3	1.10.118.414/0000
1 NO at every switching position	latching	2 x 90°		0+1+2	1.10.118.313/0000



Included: 2 keys.



PRIORITY KEYLOCK SWITCHES

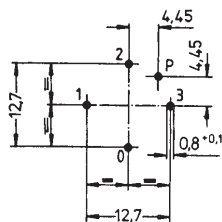
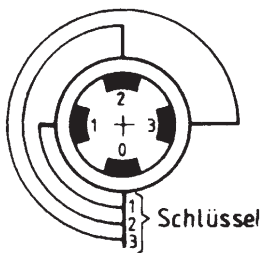
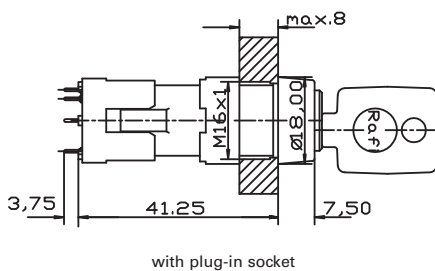
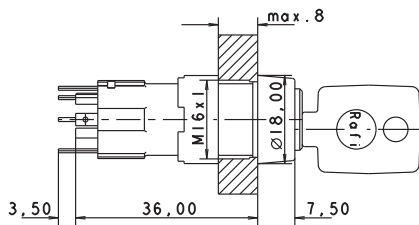
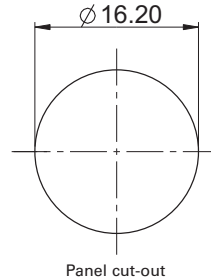

PCB hole pattern, sight on component side

→ The locking systems used in our switches are produced in accordance with DIN EN 1303 by leading lock manufacturers. The locking systems in key switches are open mechanical systems, which require occasional maintenance of the machinery or plant operator, according to the ambient conditions.

Technical Data

→ General information

Form of collar see order block

→ Dimensions

Length of collar see order block
 Diameter of collar see order block
 Width of collar see order block
 Overall height 7.5 mm
 Mounting depth 39.5 mm; with plug-in socket 41.25 mm
 Mounting hole 16.2 mm

→ Mechanical design

Mounting ring nut
 Terminals solder terminals
 Contact system sliding contact, self cleaning
 Contact function latching
 Contact arrangement 1 NO at every switching position
 Contact materials Au alloy
 Illumination no

→ Mechanical design of lock

Lock cylinder lock with pin tumblers
 Wafers 5 pins
 Lock type 5001
 Number of locking positions 10,000
 Main key yes
 Symmetric key yes
 Key removal position see order block

→ Mechanical characteristics

Operating force min. 0.035 Nm
 Operating force max. 1.8 Nm

→ Electrical characteristics





Rated voltage AC/DC max. 35 V
 Rated voltage AC/DC min. 5 V
 Rated current AC/DC max. 100 mA
 Rated current AC/DC min. 5 mA
 ESD strength max. 12 kV
 Insulation resistance $6 \times 10^8 \Omega$
 Contact resistance max. 200 m Ω

→ Other specifications

- Technical data (continued) -
Priority keylock switch

Operating life (operations)	50,000
Degree of protection from front side	IP65 (DIN EN 60529)
Operation temperature min.	-25 °C
Ambient temp. operating max.	+70 °C
Storage temperature min.	-40 °C
Storage temperature max.	+80 °C
Environmental resistance	acc. to IEC 60068-2-14, -30, -33 and -78
Soldering temperature max.	350 °C
Soldering time max.	3 s
Weight	29 g
Rotating angle	see order block
ROHS compliant	yes
REACH compliant	yes

Accessories Priority keylock switch

→ Description	Photo	Order no.	Additional accessories see page
Plug-in socket for PCB mounting		5.05.510.298/0000	1 - 71
Fixing spanner M 15, M 16		5.58.002.019/0105	5 - 25
Set of spare keys (4 keys) for 3 x 90° type		5.58.099.010/0000	-
Set of spare keys (2 keys) for 2 x 90° type		5.58.099.011/0000	-

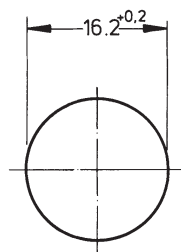
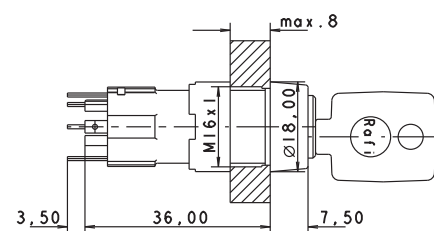

Priority keylock switch round collar

Technical data see page 1 - 68



Mounting hole



→ Contact arrangement	Contact function	Rotating angle	Key removal position	Order no.
1 NO at every switching position	latching	3 x 90°	 0	1.10.119.617/0000
1 NO at every switching position	latching	3 x 90°	 0+1+2+3	1.10.119.967/0000

PUSHBUTTONS

PRIORITY KEYLOCK SWITCHES

1

**– Table (continued) –
Priority keylock switch - round collar**

→ Contact arrangement	Contact function	Rotating angle		Key removal position	Order no.
1 NO at every switching position	latching	2 x 90°		0	1.10.119.611/0000

Included with 2 x 90° type: 2 keys; with 3 x 90° type: 3 keys.

Key 1 switches to lock position 1, key 2 switches to lock positions 1 and 2, etc...



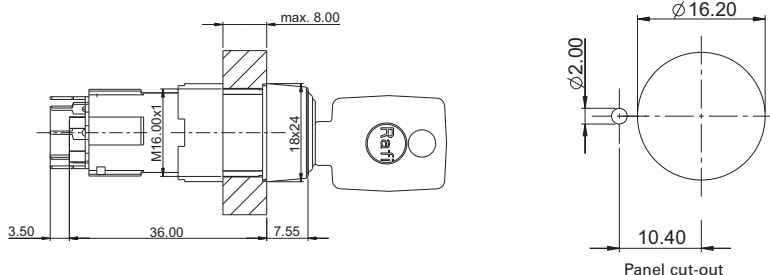

Priority keylock switch rectangular collar

Technical data see page 1 - 68



Key
Switches

→ Contact arrangement	Contact function	Rotating angle		Key removal position	Order no.
1 NO at every switching position	latching	3 x 90°		0	1.10.119.117/0000
1 NO at every switching position	latching	3 x 90°		0+1+2+3	1.10.119.467/0000
1 NO at every switching position	latching	2 x 90°		0	1.10.119.111/0000

Included with 2 x 90° type: 2 keys; with 3 x 90° type: 3 keys.

Key 1 switches to lock position 1, key 2 switches to lock positions 1 and 2, etc...

Keylock switch PCB plug-in socket

Technical data see page 1 - 68

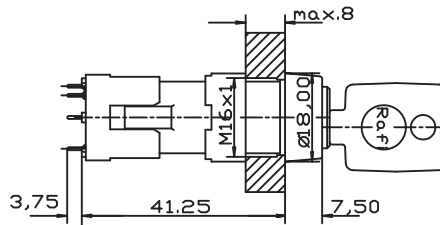

with plug-in socket

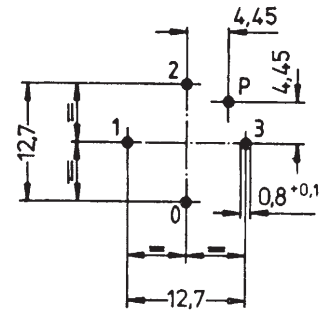

PCB hole pattern, sight on component side

→ Description	Order no.
Plug-in socket for PCB mounting	5.05.510.298/0000



Other pushbuttons

- Various pushbuttons for mounting hole diameters from 9.1 mm to 22.3 mm.
 - All products are RoHS compliant.
-

PUSHBUTTONS

OTHER PUSHBUTTONS

1

Content

Pushbuttons non-illuminated 9.1 mm, 24 V / 100 mA	1 - 75
Pushbutton non-illuminated mounting hole diameter 9.1 mm, 24 V / 100 mA	1 - 76
Pushbuttons 9.1 mm, 24 V / 0.5 A	1 - 77
Pushbutton mounting hole diameter 9.1 mm, 24 V / 0.5 A	1 - 78
Pushbuttons non-illuminated 15.2 mm, 250 V / 0.7 A	1 - 79
Pushbutton non-illuminated mounting hole diameter 15.2 mm	1 - 80
Pushbuttons non-illuminated 16.2 mm, 250 V / 2 A	1 - 81
Pushbutton non-illuminated mounting hole diameter 16.2 mm, 250 V / 2 A	1 - 82
Pushbuttons non-illuminated 18.2 mm, 250 V / 2 A	1 - 83
Pushbutton non-illuminated mounting hole diameter 18.2 mm, 250 V / 2 A	1 - 84
Pushbuttons illuminable 20.3 mm, 250 V / 2 A	1 - 85
Pushbutton with lamp socket BA9s (MBC/MCC), mounting hole diameter 20.3 mm, 250 V / 2 A	1 - 86
LUMOTAST 22 E-Stop pushbuttons, 22.3 mm	1 - 87
LUMOTAST 22 E-Stop	1 - 88

Other
Pushb.

PUSHBUTTONS NON-ILLUMINATED 9.1 mm, 24 V / 100 mA



1

Technical Data

→ General information

Form of lens	protruding lens
Color of lens	see order block
Form of collar	round

→ Dimensions

Diameter of collar	11 mm
Overall height	4.5 mm
Mounting depth	25.5 mm
Mounting hole	9.1 mm

→ Mechanical design

Mounting	ring nut
Terminals	solder terminals
Contact system	bridge contact
Contact function	momentary
Contact arrangement	1 NO
Contact materials	Ag
Illumination	no
Lamp socket	no

→ Mechanical characteristics

Operating force max.	7 N
Operating travel	2 mm
Switching travel NO	1.3 mm
Robustness max.	100 N

→ Electrical characteristics

Rated voltage AC max.	24 V
Rated voltage DC max.	24 V
Rated current max.	0.1 A
Contact resistance max.	200 mΩ

→ Other specifications

Operating life (operations)	40,000
Degree of protection from front side	IP40 (DIN EN 60529)
Operation temperature min.	-25 °C
Ambient temp. operating max.	+70 °C
Storage temperature min.	-40 °C
Storage temperature max.	+80 °C
Environmental resistance	acc. to IEC 60068-2-14, -30, -33 and -78
Weight	2 g
Soldering time max.	3 s
Soldering temperature max.	350 °C
ROHS compliant	yes
REACH compliant	yes

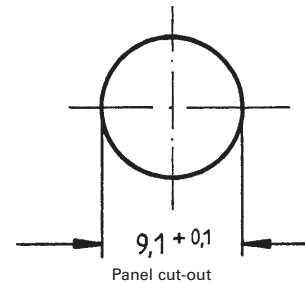

Other
Pushb.

PUSHBUTTONS

PUSHBUTTONS NON-ILLUMINATED - MOUNTING HOLE DIAMETER 9.1 MM

1

Accessories Pushbutton non-illuminated - 9.1 mm, 24 V / 100 mA

→ Description	Photo	Order no.	Additional accessories see page
Fixing spanner M 9, M 10		5.58.002.025/0105	5 - 25



Pushbutton non-illuminated mounting hole diameter 9.1 mm, 24 V / 100 mA

Technical data see page 1 - 75

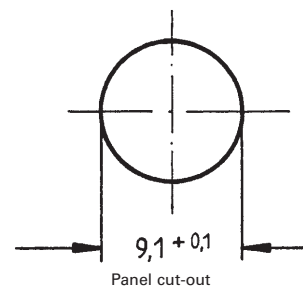
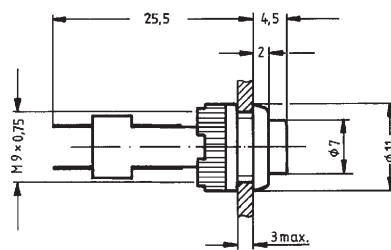

Other Pushb.

→ Contact arrangement	Contact function	Color of lens	Order no.
1 NO	momentary	opaque red	1.10.107.011/0301
1 NO	momentary	opaque yellow	1.10.107.011/0404
1 NO	momentary	opaque green	1.10.107.011/0507
1 NO	momentary	opaque white	1.10.107.011/0205
1 NO	momentary	opaque black	1.10.107.011/0104

PUSHBUTTONS

9.1 mm, 24 V / 0.5 A

Technical Data

→ General information

Form of lens	protruding lens
Color of lens	see order block
Form of collar	round

→ Dimensions

Diameter of collar	11 mm
Overall height	7 mm
Mounting depth	25 mm
Mounting hole	9.1 mm

→ Mechanical design

Mounting	ring nut
Terminals	solder terminals
Contact system	bridge contact
Contact function	momentary
Contact arrangement	1 NC + 1 NO
Contact materials	Au
Illumination	see order block
Lamp socket	no

→ Mechanical characteristics

Operating force max.	5 N
Operating travel	1.5 mm
Switching travel NC	0.5 mm
Switching travel NO	1 mm
Robustness max.	100 N

→ Electrical characteristics

Rated voltage AC/DC max.	24 V
Rated voltage DC max.	24 V
Rated current max.	0.5 A
Contact resistance when new max.	50 mΩ
Contact resistance acc. to life max.	300 mΩ
Bouncing time max.	10 ms
Lamp voltage	see order block

→ Other specifications

Operating life key switch	200,000
Degree of protection from front side	IP40 (DIN EN 60529)
Operation temperature min.	-25 °C
Ambient temp. operating max.	+70 °C, LED +55 °C
Storage temperature min.	-40 °C
Storage temperature max.	+80 °C
Environmental resistance	acc. to IEC 60068-2-14, -30, -33 and -78
Soldering temperature max.	350 °C
Soldering time max.	3 s
Weight	3 g
LED operating voltage	see order block
LED forward current	see order block
LED forward voltage	see order block
LED reverse voltage	see order block
LED reverse current	see order block
LED power dissipation	see order block
LED series resistor 5-7 V	see order block
LED series resistor 12-14 V	see order block
LED series resistor 24-28 V	see order block
ROHS compliant	yes
REACH compliant	yes

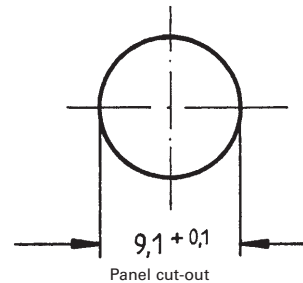

1

Other Pushb.

PUSHBUTTONS

PUSHBUTTONS ILLUMINATED - MOUNTING HOLE DIAMETER 9.1 MM

1

Accessories Pushbutton - 9.1 mm, 24 V / 0.5 A

→ Description	Photo	Order no.	Additional accessories see page
Fixing spanner M 9, M 10		5.58.002.025/0105	5 - 25



Pushbutton mounting hole diameter 9.1 mm, 24 V / 0.5 A

Technical data see page 1 - 77

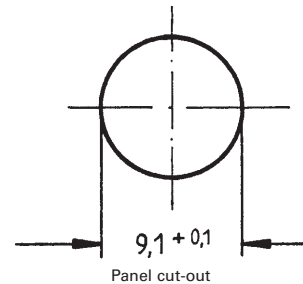
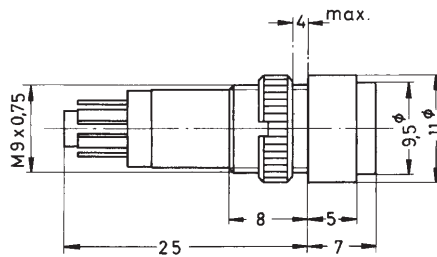

Other Pushb.

→ Contact arrangement	Contact function	Illumination	Color of lens	Order no.
1 NC + 1 NO	momentary	no	opaque red	1.15.106.301/0313
1 NC + 1 NO	momentary	no	opaque yellow	1.15.106.301/0410
1 NC + 1 NO	momentary	no	opaque green	1.15.106.301/0518
1 NC + 1 NO	momentary	no	opaque white	1.15.106.301/0214
1 NC + 1 NO	momentary	no	opaque black	1.15.106.301/0104
1 NC + 1 NO	momentary	LED super bright red	transparent red	1.15.106.501/1300
1 NC + 1 NO	momentary	LED super bright yellow	transparent yellow	1.15.106.503/1400
1 NC + 1 NO	momentary	LED super bright green	transparent green	1.15.106.502/1500
1 NC + 1 NO	momentary	LED super bright blue	transparent blue	1.15.106.504/1600
1 NC + 1 NO	momentary	LED superbright white	transparent white	1.15.106.505/1000

Recommended values for external series resistor for LED

- 5 - 7 V = 270 Ω, 0.25 W
- 12 - 14 V = 680 Ω, 0.5 W
- 24 - 28 V = 1500 Ω, 1 W

LED forward current: max. 10 mA at T = 25° C

LED forward voltage: 2V at 10 mA

LED reverse voltage: 5 V

LED reverse current: 0,1 mA

LED power dissipation: max. 120 mW at T = 50° C

Contact arrangement: 1-2 = NC, 3-4 = NO, X1-X2 = LED. Please note: connect plus with the LED anode, which is marked with a color point.

PUSHBUTTONS NON-ILLUMINATED 15.2 mm, 250 V / 0.7 A

Technical Data

→ General information

Form of lens	protruding lens
Color of lens	see order block
Form of collar	round

→ Dimensions

Diameter of collar	19 mm
Overall height	8.2 mm
Mounting depth	21.5 mm
Mounting hole	15.2 mm

→ Mechanical design

Mounting	ring nut
Terminals	see order block
Contact system	bridge contact
Contact function	momentary
Contact arrangement	see order block
Contact materials	Ag
Illumination	no
Lamp socket	no

→ Mechanical characteristics

Operating force max.	7.5 N
Operating travel	3 mm
Switching travel NC	1.2 mm
Switching travel NO	2.0 mm
Robustness max.	100 N

→ Electrical characteristics

Rated voltage AC max.	250 V
Rated current max.	0.7 A
Contact resistance when new max.	50 mΩ
Contact resistance acc. to life max.	300 mΩ

→ Other specifications

Operating life (operations)	25,000
Degree of protection from front side	IP40 acc. to DIN EN 60529 (IP65 with sealing cap)
Operation temperature min.	-25 °C
Ambient temp. operating max.	+85 °C
Storage temperature min.	-40 °C
Storage temperature max.	+90 °C
Environmental resistance	acc. to IEC 60068-2-14, -30, -33 and -78
Weight	7 g
Flame class acc. to UL 94	V 0
Hot wire ignition acc. to IEC 60695-2-1	yes
ROHS compliant	yes
REACH compliant	yes

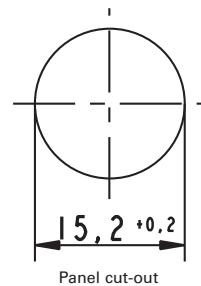

Approvals





ENEC 25T85

PUSHBUTTONS

PUSHBUTTONS NON-ILLUMINATED - MOUNTING HOLE DIAMETER 15.2 MM

1

Accessories Pushbutton non-illuminated - 15.2 mm, 250 V / 0.7 A

→ Description	Photo	Order no.	Additional accessories see page
Sealing cap, transparent, for protection acc. to IP65		5.52.008.115/0000	-
Fixing spanner M 15, M 16		5.58.002.019/0105	5 - 25



Pushbutton non-illuminated mounting hole diameter 15.2 mm

Technical data see page 1 - 79

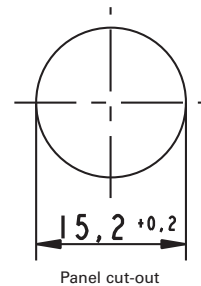
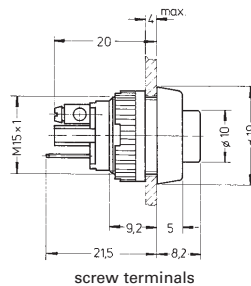

Other Pushb.

→ Contact arrangement	Contact function	Color of lens	Terminals	Order no.
1 NO	momentary	opaque red	screw terminals	1.10.001.001/0301
1 NO	momentary	opaque red	solder/quick connector 6.3x0.8 / 2x 2.8x0.8mm	1.10.001.011/0301
1 NO	momentary	opaque green	screw terminals	1.10.001.001/0507
1 NO	momentary	opaque green	solder/quick connector 6.3x0.8 / 2x 2.8x0.8mm	1.10.001.011/0507
1 NO	momentary	opaque white	screw terminals	1.10.001.001/0205
1 NO	momentary	opaque white	solder/quick connector 6.3x0.8 / 2x 2.8x0.8mm	1.10.001.011/0205
1 NO	momentary	opaque black	screw terminals	1.10.001.001/0104
1 NO	momentary	opaque black	solder/quick connector 6.3x0.8 / 2x 2.8x0.8mm	1.10.001.011/0104
1 NC	momentary	opaque red	screw terminals	1.10.001.151/0301
1 NC	momentary	opaque red	solder/quick connector 6.3x0.8 / 2x 2.8x0.8mm	1.10.001.161/0301
1 NC	momentary	opaque black	screw terminals	1.10.001.151/0104
1 NC	momentary	opaque black	solder/quick connector 6.3x0.8 / 2x 2.8x0.8mm	1.10.001.161/0104

Quick-connector 6.3 x 0.8 mm. The connector is splitted and also usable for two connectors 2.8 x 0.8 mm.

PUSHBUTTONS NON-ILLUMINATED 16.2 mm, 250 V / 2 A

Technical Data

→ General information	
Form of lens	protruding lens
Color of lens	see order block
Form of collar	round
→ Dimensions	
Diameter of collar	20 mm
Overall height	9 mm
Mounting depth	41 mm
Mounting hole	16.2 mm
→ Mechanical design	
Mounting	ring nut
Terminals	screw terminals
Contact system	bridge contact
Contact function	momentary
Contact arrangement	see order block
Contact materials	Ag
Illumination	no
Lamp socket	no
→ Mechanical characteristics	
Operating force max.	7.5 N
Operating travel	4.3 mm
Switching travel NC	1.3 mm
Switching travel NO	2.2 mm
Robustness max.	100 N
→ Electrical characteristics	
Rated voltage AC max.	250 V
Rated current max.	2 A
Contact resistance when new max.	100 mΩ
→ Other specifications	
Operating life (operations)	150,000
Degree of protection from front side	IP40 acc. to DIN EN 60529 (IP65 with sealing cap)
Operation temperature min.	-25 °C
Ambient temp. operating max.	+85 °C
Storage temperature min.	-40 °C
Storage temperature max.	+90 °C
Environmental resistance	acc. to IEC 60068-2-14, -30, -33 and -78
Weight	11 g
Flame class acc. to UL 94	V 0
Hot wire ignition acc. to IEC 60695-2-1	yes
ROHS compliant	yes
REACH compliant	yes

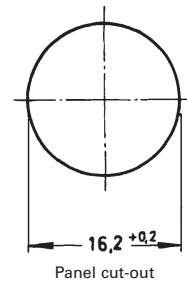

Approvals



1

Other Pushb.

Accessories Pushbutton non-illuminated - 16.2 mm, 250 V / 2 A

→ Description	Photo	Order no.	Additional accessories see page
Sealing cap, black, for protection acc. to IP65		5.52.008.101/0100	-



PUSHBUTTONS

PUSHBUTTONS NON-ILLUMINATED - MOUNTING HOLE DIAMETER 16.2 MM

1

– Table (continued) –

Accessories Pushbutton non-illuminated - 16.2 mm, 250 V / 2 A

Description	Photo	Order no.	Additional accessories see page
Sealing cap, red, for protection acc. to IP65		5.52.008.101/0300	-
Protective sleeve for terminals		5.52.011.026/0100	-
Protection against contact to VBG 4		5.55.101.715/0200	5 - 31
Fixing spanner M 15, M 16		5.58.002.019/0105	5 - 25



Pushbutton non-illuminated mounting hole diameter 16.2 mm, 250 V / 2 A

Technical data see page 1 - 81

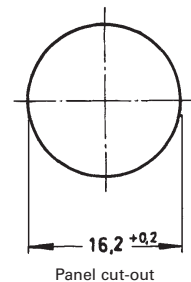
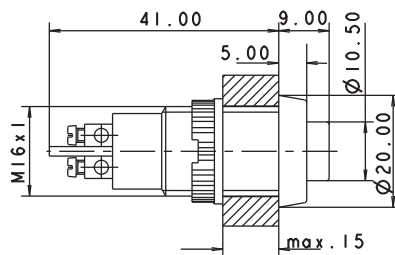

Other Pushb.

Contact arrangement	Contact function	Color of lens	Order no.
1 NO	momentary	opaque red	1.10.102.001/0301
1 NO	momentary	opaque green	1.10.102.001/0507
1 NO	momentary	opaque white	1.10.102.001/0205
1 NO	momentary	opaque black	1.10.102.001/0104
1 NC	momentary	opaque red	1.10.102.011/0301
1 NC	momentary	opaque black	1.10.102.011/0104

PUSHBUTTONS NON-ILLUMINATED 18.2 mm, 250 V / 2 A

Technical Data

→ General information	
Form of lens	protruding lens
Color of lens	see order block
Form of collar	round
→ Dimensions	
Diameter of collar	22 mm
Overall height	10.5 mm
Mounting depth	34 mm
Mounting hole	18.2 mm
→ Mechanical design	
Mounting	ring nut
Terminals	see order block
Contact system	sliding bridge contact
Contact function	momentary
Contact arrangement	see order block
Contact materials	Ag
Illumination	no
Lamp socket	no
→ Mechanical characteristics	
Operating force max.	9.5 N
Operating travel	5 mm
Switching travel NC	2.1 mm
Switching travel NO	3.7 mm
Robustness max.	100 N
→ Electrical characteristics	
Rated voltage AC max.	250 V
Rated current max.	2 A
Contact resistance acc. to life max.	200 mΩ
→ Other specifications	
Operating life (operations)	50,000
Degree of protection from front side	IP40 acc. to DIN EN 60529 (IP65 with sealing cap)
Operation temperature min.	-25 °C
Ambient temp. operating max.	+85 °C
Storage temperature min.	-40 °C
Storage temperature max.	+90 °C
Environmental resistance	acc. to IEC 60068-2-14, -30, -33 and -78
Weight	14 g
Flame class acc. to UL 94	V 0
Hot wire ignition acc. to IEC 60695-2-1	yes
ROHS compliant	yes
REACH compliant	yes

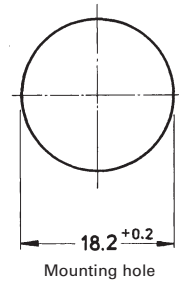

Approvals



1

Other Pushb.

Accessories Pushbutton non-illuminated - 18.2 mm, 250 V / 2 A

Description	Photo	Order no.	Additional accessories see page
Neoprene sealing cap, black, for protection acc. to IP65		5.52.008.061/0100	-



PUSHBUTTONS

PUSHBUTTONS NON-ILLUMINATED - MOUNTING HOLE DIAMETER 18.2 MM

1

– Table (continued) –

Accessories Pushbutton non-illuminated - 18.2 mm, 250 V / 2 A

→ Description	Photo	Order no.	Additional accessories see page
Silicone sealing cap, for protection acc. to IP65		5.52.008.065/0000	-
Protective sleeve for terminals		5.52.011.028/0100	-
Fixing spanner M 18, M 19		5.58.002.017/0105	5 - 25

Other Pushb.



Pushbutton non-illuminated mounting hole diameter 18.2 mm, 250 V / 2 A

Technical data see page 1 - 83

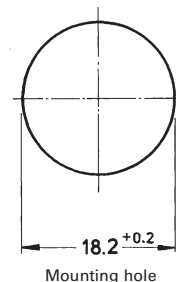
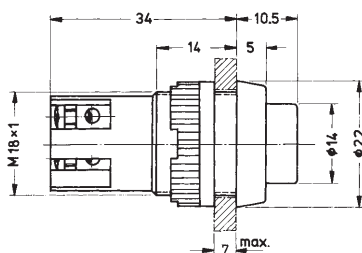

→ Contact arrangement	Color of lens	Order no.
2 NO	opaque red	1.01.102.001/0301
2 NO	opaque green	1.01.102.001/0507
2 NO	opaque black	1.01.102.001/0104
1 NC + 1 NO	opaque red	1.01.102.011/0301
1 NC + 1 NO	opaque green	1.01.102.011/0507
1 NC + 1 NO	opaque white	1.01.102.011/0205
1 NC + 1 NO	opaque black	1.01.102.011/0104

PUSHBUTTONS ILLUMINABLE 20.3 mm, 250 V / 2 A

Technical Data

→ General information

Form of lens	protruding lens
Color of lens	see order block
Form of collar	round

→ Dimensions

Diameter of collar	24 mm
Overall height	9 mm
Mounting depth	45.5 mm
Mounting hole	20.3 mm

→ Mechanical design

Mounting	ring nut
Terminals	solder/quick connect terminals 2.8 x 0.8 mm
Contact system	bridge contact
Contact function	momentary
Contact arrangement	see order block
Contact materials	Ag
Illumination	yes
Lamp socket	BA 9 s

→ Mechanical characteristics

Operating force max.	10 N
Operating travel	3.6 mm
Switching travel NC	0.8 mm
Switching travel NO	2.9 mm
Robustness max.	100 N

→ Electrical characteristics

Rated voltage AC max.	250 V
Rated current max.	2 A
Contact resistance acc. to life max.	200 mΩ

→ Other specifications

Operating life (operations)	100,000
Degree of protection from front side	IP40 acc. to DIN EN 60529 (IP65 with sealing cap)
Operation temperature min.	-25 °C
Ambient temp. operating max.	+85 °C
Storage temperature min.	-40 °C
Storage temperature max.	+90 °C
Environmental resistance	acc. to IEC 60068-2-14, -30, -33 and -78
Weight	18 g
Flame class acc. to UL 94	V 0
Hot wire ignition acc. to IEC 60695-2-1	yes
ROHS compliant	yes
REACH compliant	yes

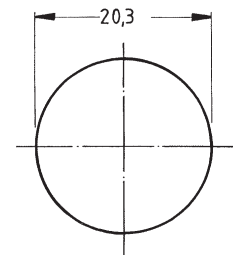
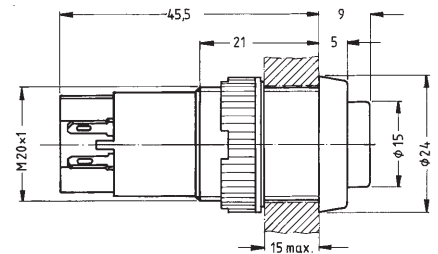

Mounting hole

Approvals







PUSHBUTTONS

PUSHBUTTON ILLUMINABLE - MOUNTING HOLE DIAMETER 20.3 MM, BA9S

1

Accessories Pushbutton illuminable - 20.3 mm, 250 V / 2 A

→ Description	Photo	Order no.	Additional accessories see page
LED BA 9s (MBC/MCC) superbright, red, 24 V		1.90.690.341/0000	5 - 8
LED BA 9s (MBC/MCC) superbright, green, 24 V		1.90.690.342/0000	5 - 8
LED BA 9s (MBC/MCC) superbright, yellow, 24 V		1.90.690.343/0000	5 - 8
LED BA 9s (MBC/MCC) superbright, blue, 24 V		1.90.690.344/0000	5 - 8
LED BA 9s (MBC/MCC) superbright, white, 24 V		1.90.690.345/0000	5 - 8
Silicone sealing cap, for protection acc. to IP65		5.52.008.065/0000	-
Protective sleeve for terminals		5.52.011.030/0100	-
Fixing spanner M 20, M 22, for ring nut		5.58.002.018/0105	5 - 25

Other Pushb.



Pushbutton with lamp socket BA9s (MBC/MCC), mounting hole diameter 20.3 mm, 250 V / 2 A

Technical data see page 1 - 85

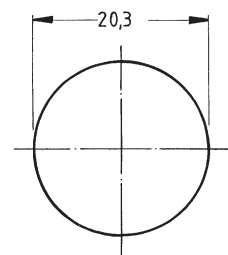
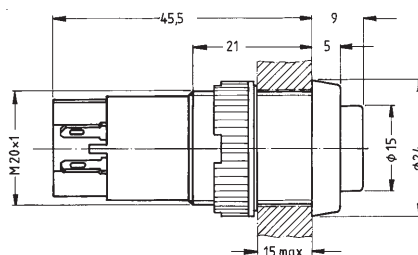

Mounting hole

→ Contact arrangement	Contact function	Order no.	Note
1 NO	momentary	1.15.112.101/0000	Please include the desired lens in your order.
1 NC + 1 NO	momentary	1.15.112.121/0000	Please include the desired lens in your order.

Lenses:

- Lens, transparent colorless: 5.49.205.008/1002
- Lens, transparent red: 5.49.205.008/1303
- Lens, transparent yellow: 5.49.205.008/1402
- Lens, transparent green: 5.49.205.008/1502

LUMOTAST 22 E-STOP PUSH- BUTTONS, 22.3 MM

→ The emergency stop pushbuttons comply with IEC 60 204, IEC 60 073, IEC 60 947 and VDE 0113 Part 1.

They are designed dupe-proof according to EN 418 with a positive mechanical movement sequence. A certain operating force must be exerted at the action point in order to prevent inadvertent operation. The pushbutton latches when pressed.

The special shape of the actuator prevents the emergency stop pushbutton from being blocked. This means that the emergency stop process - once initiated - cannot be impeded by any jamming objects.

Original manual see „Appendix“

Technical Data

→ General information

Form of lens	conical mushroom form
Color of lens	red
Form of collar	round

→ Dimensions

Mushroom Diameter	30 mm
Overall height	25.9 mm
Mounting depth	17.6 mm
Mounting hole	22.3 mm

→ Mechanical design

Mounting	ring nut
Terminals	quick connector 2.8 x 0.8 mm, solderable
Torque for nut ring	1.9 Nm
Contact function	latching
Contact arrangement	see order block
Illuminability	see order block
Reset	by rotation

→ Mechanical characteristics

Robustness max.	100 N
-----------------	-------

→ Electrical characteristics acc. to IEC/EN 60947-5-1 (VDE 0660 Part 200)

Application category	AC15/DC13
Rated insulation voltage U_i	250V (AC/DC)
Rated operating voltage U_e	250V AC, 240V DC
{Term. Dauerstrom}	2.5A (AC/DC)

→ Other specifications

Ambient temp. operating min.	-25 °C
Ambient temp. operating max.	+70 °C
Robustness	acc. to IEC 600 68-2-3 und 2-30
Operating life (operations) / B10	15,000
Degree of protection from front side	IP65 (DIN EN 60529)
Storage temperature min.	-40 °C
Storage temperature max.	+80 °C
Environmental resistance	acc. to IEC 60068-2-14, -30, -33 and -78
Salt spray	IEC 600 68-2-11
Solder techniques	manual soldering, lead-free
Soldering temperature max.	350 °C
Soldering time max.	5 s
ROHS compliant	yes
REACH compliant	yes



NEW

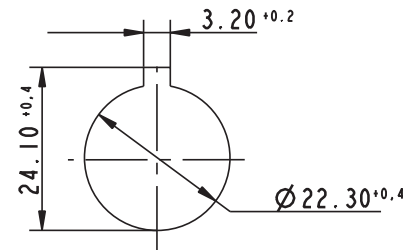
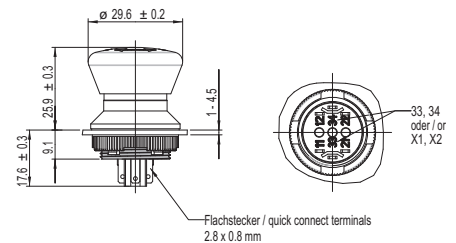

Panel cut-out to IEC 60947-5-1

Approvals



PUSHBUTTONS

LUMOTAST 22 - E-STOP, MOUNTING HOLE DIAMETER 22.3 MM

1

Accessories LUMOTAST 22 E-Stop, 22.3 mm

→ Description	Photo	Order no.	Additional accessories see page
Fixing spanner for ring nut		5.05.800.062/0000	2 - 145, 2 - 261, 5 - 25



LUMOTAST 22 E-Stop

Technical data see page 1 - 87

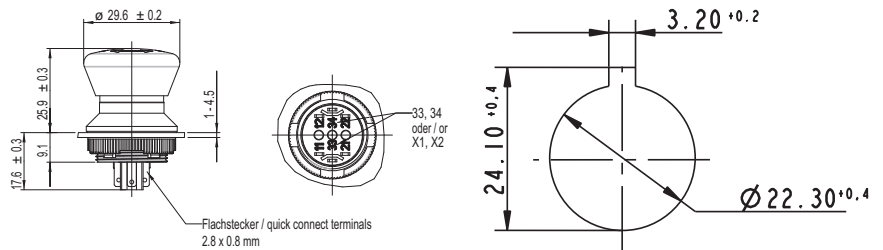

Panel cut-out to IEC 60947-5-1

Other Pushb.

→ Contact arrangement	Illuminability	Degree of protection from front side	Order no.
2 NC + 1 NO	no	IP65 (DIN EN 60529)	1.15.105.021/0000
2 NC	arrows with 2 LED	IP65 (DIN EN 60529)	1.15.105.011/0000
2 NC	no	IP65 (DIN EN 60529)	1.15.105.001/0000



RAFIX 16

RAFIX 16 control component range

- Panel cut-out acc. to IEC 60947: Ø 16,2 mm / Ø 22,3 mm / □ 23,1 mm
- 250 V / 6 A max.
- Degree of protection: IP65 acc. to DIN EN 60529
- Contact blocks: Gold and silver contacts with quick-connect terminals 2.8 x 0.8 mm or screw terminals; Option: PCB plug-in socket
- 3 collar shapes RAFIX 16, 2 collar shapes RAFIX 16F
- The contact blocks snap directly onto the actuators without a coupling element and can be easily removed by turning = cost reducing assembly.
- All products are RoHS compliant.

The specified data apply only if actuators are combined with contact blocks and signal indicators with lamp sockets within the same product range.

CONTROL COMPONENTS

RAFIX 16

Content

RAFIX 16 Pushbuttons	2 - 9
RAFIX 16 Pushbutton, flush lens, square collar	2 - 10
RAFIX 16 Pushbutton, protruding lens, square collar	2 - 11
RAFIX 16 Pushbutton, protruding collar, square collar	2 - 12
RAFIX 16 Pushbutton, flush lens, round collar	2 - 12
RAFIX 16 Pushbutton IP66 with protective cap	2 - 13
RAFIX 16 Pushbutton, protruding lens, round collar	2 - 14
RAFIX 16 Pushbutton, protruding collar, round collar	2 - 15
RAFIX 16 Pushbutton, flush lens, square collar, alignable without gaps	2 - 15
RAFIX 16 Selector switches	2 - 17
RAFIX 16 Selector switch, square collar	2 - 18
RAFIX 16 Selector switch, round collar	2 - 19
RAFIX 16 Selector switch, square collar, alignable without gaps	2 - 20
RAFIX 16 Keylock switches	2 - 21
RAFIX 16 Keylock switch, square collar	2 - 22
RAFIX 16 Keylock switch, round collar	2 - 23
RAFIX 16 Keylock switch, square collar, alignable without gaps	2 - 24
RAFIX 16 Mushroom-headed pushbuttons	2 - 25
RAFIX 16 Mushroom-headed pushbutton, round collar	2 - 26
RAFIX 16 Emergency stop pushbuttons	2 - 27
RAFIX 16 Emergency stop pushbutton, round collar, dupe-proof, non-blocking	2 - 28
RAFIX 16 Emergency stop pushbutton, round collar, conical, dupe-proof, non-blocking	2 - 29
RAFIX 16 Toggle switches	2 - 30
RAFIX 16 Toggle switch, square collar	2 - 31
RAFIX 16 Toggle switch, round collar	2 - 31
RAFIX 16 Toggle switch, square collar, alignable without gaps	2 - 32
RAFIX 16 Potentiometer drives	2 - 33
RAFIX 16 Potentiometer drive, square collar	2 - 34
RAFIX 16 Potentiometer drive, round collar	2 - 34
RAFIX 16 Potentiometer drive, square collar, alignable without gaps	2 - 35
RAFIX 16 Buzzers	2 - 36
RAFIX 16 Buzzer, square collar	2 - 37
RAFIX 16 Buzzer, round collar	2 - 37
RAFIX 16 Buzzer, square collar, alignable without gaps	2 - 38
RAFIX 16 Signal indicators	2 - 39
RAFIX 16 Signal indicator, square lens	2 - 40
RAFIX 16 Signal indicator, square collar, flush lens	2 - 40
RAFIX 16 Signal indicator, round lens	2 - 41
RAFIX 16 F Pushbuttons	2 - 43
RAFIX 16 F Pushbutton, flush lens, square black collar	2 - 44
RAFIX 16 F Pushbutton, flush lens, round black collar	2 - 45
RAFIX 16 F Pushbutton, flush lens, round metallized collar	2 - 46
RAFIX 16 F Selector switches	2 - 47
RAFIX 16 F Selector switch, square black collar	2 - 48
RAFIX 16 F Selector switch, round black collar	2 - 49
RAFIX 16 F Selector switch, round metallized collar	2 - 50
RAFIX 16 F Keylock switches	2 - 52
RAFIX 16 F Keylock switch, square black collar	2 - 53
RAFIX 16 F Keylock switch, round black collar	2 - 54
RAFIX 16 F Keylock switch, round metallized collar	2 - 55

2

RAFIX
16

Content

RAFIX 16 F Emergency stop pushbuttons	2 - 56
RAFIX 16 F Emergency stop pushbutton, square collar	2 - 57
RAFIX 16 F Emergency stop pushbutton, round collar	2 - 58
RAFIX 16 F Signal indicators	2 - 59
RAFIX 16 F Signal indicator, flush lens, square black collar	2 - 60
RAFIX 16 F Signal indicator, flush lens, round black collar	2 - 60
RAFIX 16 F Signal indicator, flush lens, round metallized collar	2 - 61
RAFIX 16 Contact blocks with gold contacts	2 - 62
RAFIX 16 Standard contact block, gold contacts, with quick-connect terminals	2 - 63
RAFIX 16 Standard contact block, gold contacts, with screw terminals	2 - 64
RAFIX 16 Universal contact block, gold contacts, with quick-connect terminals	2 - 65
RAFIX 16 Universal contact block, gold contacts, with screw terminals	2 - 66
RAFIX 16 Contact blocks with silver contacts	2 - 67
RAFIX 16 Standard contact block, silver contacts, with quick-connect terminals	2 - 68
RAFIX 16 Standard contact block, silver contacts, with screw terminals	2 - 69
RAFIX 16 Universal contact block, silver contacts, with quick-connect terminals	2 - 70
RAFIX 16 Universal contact block with coupling monitoring, silver contacts, with quick-connect terminals	2 - 71
RAFIX 16 Universal contact block, silver contacts, with screw terminals	2 - 71
RAFIX 16 Lamp sockets	2 - 73
RAFIX 16 Lamp socket W 2 x 4.6 d	2 - 74
RAFIX 16 Lamp socket W 2 x 4.6 d	2 - 74
RAFIX 16 Special accessories	2 - 75
PCB plug-in socket	2 - 75
Multipole connector	2 - 76
Female quick-connect terminal DIN 46340-B 2.8-1-MS	2 - 76
Plug distributor	2 - 76
Protection against contact	2 - 77
Protective cover, suitable for lead seal, for pushbuttons, alignable without gaps	2 - 77
Fixing spanner for hexagon nut	2 - 78
RAFIX Insulating housing, Ø 16.2 mm	2 - 78
RAFIX Insulating housing IP65, Ø 22.3 mm	2 - 79
RAFIX 16 Label holder, flush, for square collar	2 - 80
RAFIX 16 Label holder, flush, for round collar	2 - 80
RAFIX 16 Label holder, protruding, for square flush fitting collar	2 - 81
Emergency stop label, PVC adhesive, Ø 16.3 mm	2 - 81
Emergency stop label, Ø 22.3 mm	2 - 82
RAFIX 16 Blanking cap with sealing and threaded ring, Ø 16.2 mm	2 - 83
RAFIX 16 F Blanking cap	2 - 83

CONTROL COMPONENTS

RAFIX 16 - GENERAL INFORMATION

Control Components RAFIX 16

RAFIX 16 is a complete control component series and enables you to design attractive control panels with a minimum of space requirements and at the same time sufficiently large actuating areas.



RAFIX 16 F, round

Actuators

Mounting hole according to IEC 60947

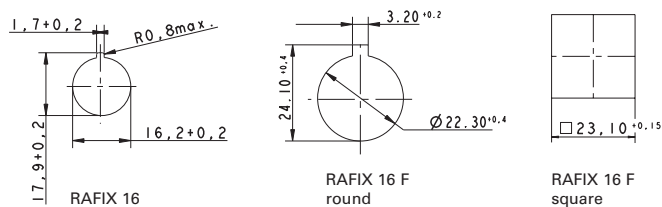

- Locating lug (easily removable).
The locating lug can be easily removed using a screwdriver.

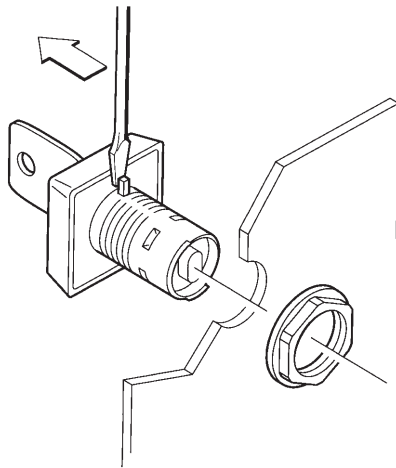

- Degree of protection IP65 on frontside of the panel.
This is achieved by a reliable, tried and tested special seal.

RAFIX 16 actuators

- Grid spacing 25 x 25 mm (RAFIX 16 F 30 x 30 mm)
- 7 mm height from front panel (RAFIX 16 F 1.9 mm)
- Three collar shapes, in black
 - Square
 - Round
 - Square, alignable in flush fitting rows, which avoids accumulation of dirt between the collars.

Contact blocks

- Contact blocks standard: for actuators with one-way operation
 - latching function
 - momentary function
- Contact blocks universal: for E-stop pushbuttons and for actuators with two-way operation, e. g. selector or keylock switches
 - momentary function

Contact material

- Silver contacts for mains voltage
- Gold contacts for electronic circuits

Illumination

- LED or wedge base lamp, socket W 2 x 4.6 d

Assembly

- Single-handed cost-effective assembly method
- Panel thickness 0.5 ... 5 mm for RAFIX 16 (RAFIX 16 F 0.5 ... 3.5 mm)
- Fixing with hexagon nut
- Starting torque 1.2 Nm max.

Shock-resistance according to IEC 600 68-2-27

- Shock amplitude: ≤ 50 g
- Shock time: 11 ms
- Shock type: half sinusoidal

Environment conditions

- acc. to IEC 600 68-2, -14, -30, -33 and -78

Temperature range

- Operating temperature:
 - non-illuminated: - 25 ... + 70 °C
 - illuminated: - 25 ... + 55 °C (with LED)
- Storage temperature: - 40 ... + 85 °C

2

RAFIX
16

Dimensional Drawings

Actuator with contact block resp. signal indicator with lamp socket

Contact block with quick-connect terminals and RAFIX 16 pushbutton

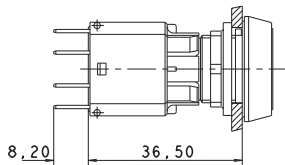

... with protection cage

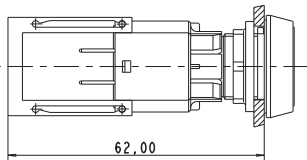

... with multipole connector

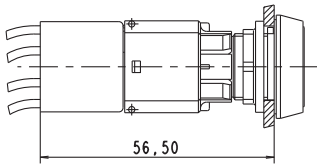

... with PCB plug-in socket

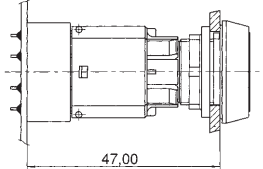

Contact block with screw terminals and RAFIX 16 pushbutton

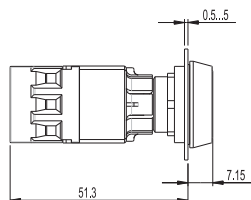

Contact block with quick-connect terminals and RAFIX 16 F keylock switch

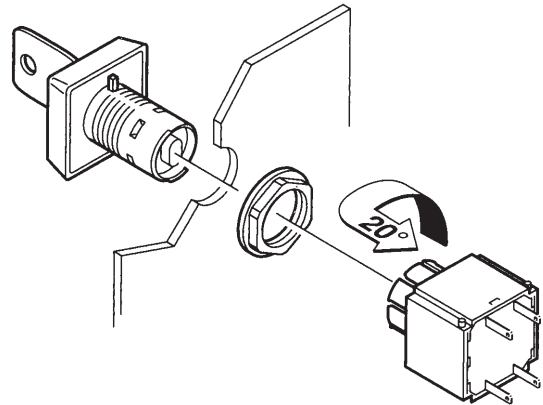
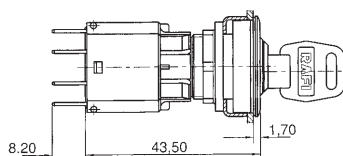

Assembly/Disassembly

Assembly

- Insert the actuator through the panel cut-out from the front.
- If there is no locating indent provided in the cut-out, first remove the locating lug using a screwdriver.
- Screw the hexagon nut onto the actuator or signal indicator from the rear and tighten it using a fixing spanner.
- Click the contact block onto the actuator from the rear.
- Install protection against accidental contact, if applicable.
- Install PCB if applicable.

With quick-connect terminals

Contact cables with quick connector

With screw terminals

Push in cables and fix by screwing

Disassembly

- Turn the contact block by approx. 20° to the left or right – the latches open.
- Pull the contact block off towards the rear.
- To dismount a PCB, pull the PCB with the soldered plug-in sockets off the mounted contact blocks.

CONTROL COMPONENTS

RAFIX 16 - GENERAL INFORMATION

Legending

- **Label holders**
All elements can be labelled using a **separate label holder**. The label holder is mounted together with the actuator/signal indicator.
- **Non-illuminated pushbuttons and mushroom-headed pushbuttons**
Can be **printed** or laser engraved.
- **Legend inserts**
All illuminated pushbuttons and the majority of the signal indicators can be **labelled by means of legend inserts**. The legend inserts are fitted between actuator body and lens and can be easily changed.

Alternatively, the plungers can be printed directly. The mounted lens protects the printing against abrasion.

RAFI also provides custom legending. Price and delivery on request.

Lamp replacement from front

Use the disassembly tool to grasp the actuator body and pull it towards the front with the lens. Alternatively, you can use a screwdriver in place of the disassembly tool. In this case, insert the screwdriver between actuator body and collar and carefully raise the actuator body. Replace the lamp using a lamp extractor or a suitable insulation sleeve.

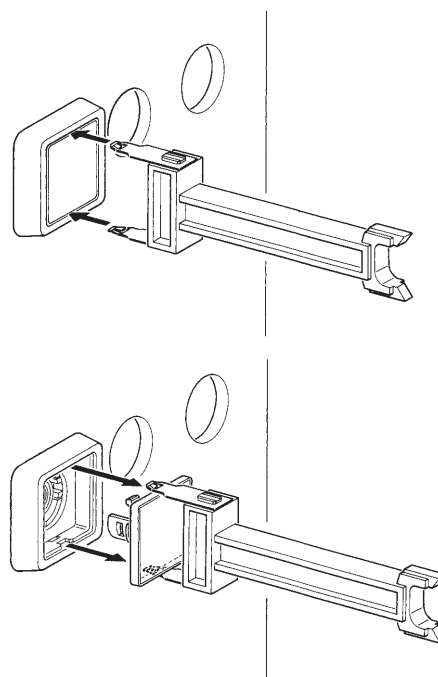

Lamp replacement from front

2

RAFIX
16

RAFIX 16 Pushbuttons

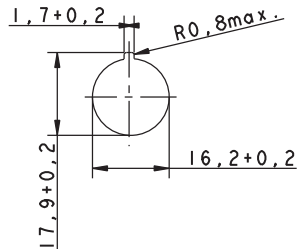

Panel cut-out



Technical Data

→ General information

Actuator	see order block
Color of lens	see order block
Form of collar	see order block

→ Dimensions

Collar dimensions	see order block
Overall height	see order block
Mounting depth	44.7 mm
Mounting hole	16.2 mm
Key grid	25 x 25 mm

→ Mechanical design

Mounting	ring nut, max. 1.2 Nm
Contact function	according to contact block
Contact arrangement	according to contact block
Illumination	see order block

→ Mechanical characteristics

Operating travel	3 mm
Robustness max.	100 N

→ Other specifications

Operating life (operations)	2,000,000
Degree of protection from front side	IP65 (DIN EN 60529)
Operation temperature min.	-25 °C
Ambient temp. operating max. without lamp /LED	+70 °C
Ambient temp. operating max. with lamp /LED	+55 °C
Storage temperature min.	-40 °C
Storage temperature max.	+85 °C
Environmental resistance	acc. to IEC 60068-2-14, -30, -33 and -78
ROHS compliant	yes
REACH compliant	yes

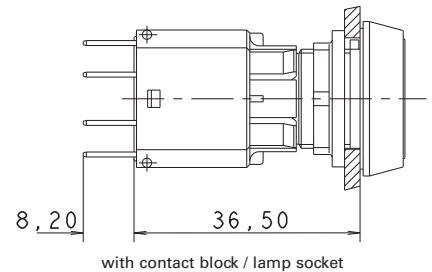

with contact block / lamp socket

Approvals



IEC 61058, 25T70
without lamp,
25T55 with lamp

C22.2 No.
14-M91

Accessories RAFIX 16 - Pushbutton



→ Description

Description	Photo	Order no.	Additional accessories see page
RAFIX 16 - Contact blocks with gold contacts		-	2 - 62
RAFIX 16 - Contact blocks with silver contacts		-	2 - 67

CONTROL COMPONENTS

RAFIX 16 - ACTUATORS AND SIGNAL INDICATORS

– Table (continued) –
Accessories RAFIX 16 - Pushbutton

→ Description	Photo	Order no.	Additional accessories see page
Socket W 2 x 4.6d, LED superbright		-	5 - 5
Disassembly tool for LUMOTAST 25, RAFIX 16		5.05.800.042/0000	5 - 27
Fixing spanner for hexagon nut		5.58.002.034/0000	2 - 78, 5 - 26



RAFIX 16 Pushbutton, flush lens, square collar

Technical data see page 2 - 9

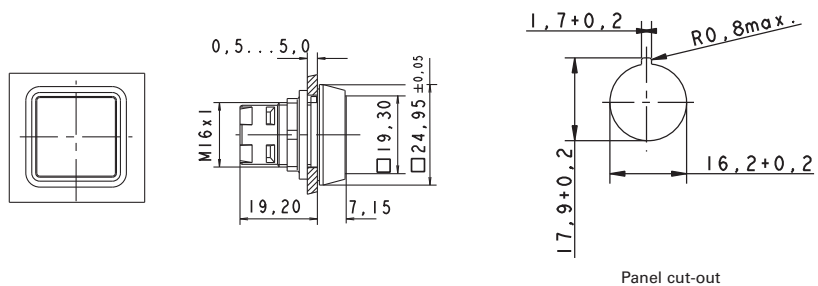

Panel cut-out

→ Illumination	Color of lens	Order no. complete	Order no. single parts	
			Housing	Lens
yes	transparent red	1.30.070.001/1306	1.30.070.501/0000	5.49.077.011/1306
yes	transparent yellow	1.30.070.001/1403	1.30.070.501/0000	5.49.077.011/1403
yes	transparent green	1.30.070.001/1505	1.30.070.501/0000	5.49.077.011/1505
yes	transparent blue	1.30.070.001/1607	1.30.070.501/0000	5.49.077.011/1607
yes	transparent colorless	1.30.070.001/1002	1.30.070.501/0000	5.49.077.011/1002
no	opaque red	1.30.070.251/0300	1.30.070.501/0000	5.49.077.011/0313
no	opaque yellow	1.30.070.251/0400	1.30.070.501/0000	5.49.077.011/0410
no	opaque green	1.30.070.251/0500	1.30.070.501/0000	5.49.077.011/0518
no	opaque blue	1.30.070.251/0600	1.30.070.501/0000	5.49.077.011/0612
no	opaque white	1.30.070.251/0200	1.30.070.501/0000	5.49.077.011/0200
no	opaque black	1.30.070.251/0100	1.30.070.501/0000	5.49.077.011/0104

For the „latching“ function, please use the standard contact block with „latching“ function.

Accessoires:

Legend insert, blank, use only for transparent lenses: 5.70.635.000/2000

RAFIX 16 - Label holder, flush, for square collar: see page 2 - 80

RAFIX 16 Pushbutton, protruding lens, square collar

Technical data see page 2 - 9

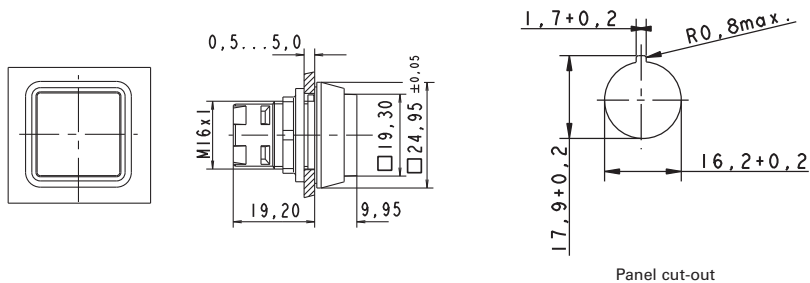

2

→ Illumination	Color of lens	Order no. complete	Order no. single parts	
			Housing	Lens
yes	transparent red	1.30.070.051/1306	1.30.070.551/0000	5.49.077.012/1306
yes	transparent yellow	1.30.070.051/1403	1.30.070.551/0000	5.49.077.012/1403
yes	transparent green	1.30.070.051/1505	1.30.070.551/0000	5.49.077.012/1505
yes	transparent blue	1.30.070.051/1607	1.30.070.551/0000	5.49.077.012/1607
yes	transparent colorless	1.30.070.051/1002	1.30.070.551/0000	5.49.077.012/1002
no	opaque red	1.30.070.301/0300	1.30.070.801/0000	5.46.657.442/0300
no	opaque black	1.30.070.301/0100	1.30.070.801/0000	5.46.657.442/0100

For the „latching“ function, please use the standard contact block with „latching“ function.

Accessoires:

Legend insert, blank, use only for transparent lenses: 5.70.635.000/2000

RAFIX 16 - Label holder, flush, for square collar: see page 2 - 80

RAFIX
16

CONTROL COMPONENTS

RAFIX 16 - ACTUATORS AND SIGNAL INDICATORS



RAFIX 16 Pushbutton, protruding collar, square collar

Technical data see page 2 - 9

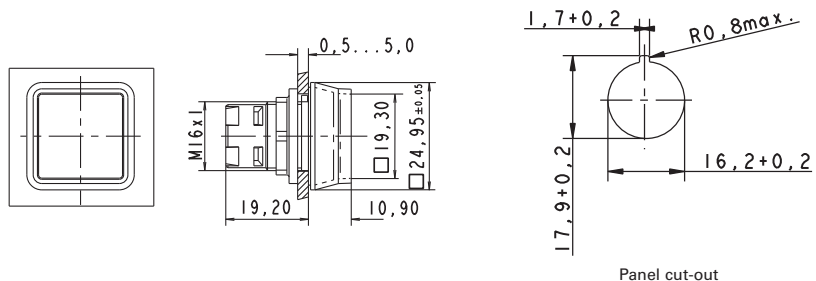

Panel cut-out

2

RAFIX
16

→ Illumination	Color of lens	Order no. complete	Order no. single parts	
			Housing	Lens
yes	transparent red	1.30.070.101/1306	1.30.070.601/0000	5.49.077.011/1306
yes	transparent yellow	1.30.070.101/1403	1.30.070.601/0000	5.49.077.011/1403
yes	transparent green	1.30.070.101/1505	1.30.070.601/0000	5.49.077.011/1505
yes	transparent blue	1.30.070.101/1607	1.30.070.601/0000	5.49.077.011/1607
yes	transparent colorless	1.30.070.101/1002	1.30.070.601/0000	5.49.077.011/1002

The protruding collar offers protection against inadvertent operation and thereby fulfils the safety requirements of various machinery manufacturers.

For the „latching“ function, please use the standard contact block with „latching“ function.

Accessoires:

Legend insert, blank, use only for transparent lenses: 5.70.635.000/2000

RAFIX 16 - Label holder, flush, for square collar: see page 2 - 80



RAFIX 16 Pushbutton, flush lens, round collar

Technical data see page 2 - 9

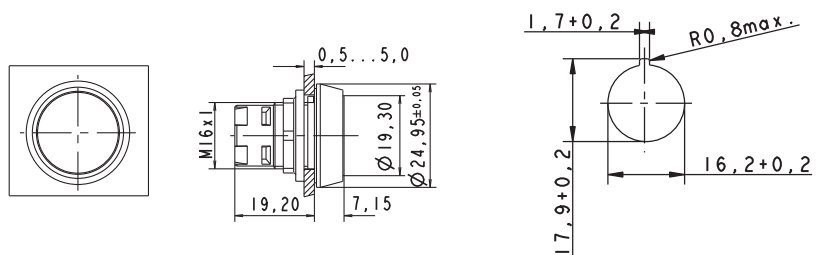

Panel cut-out

– Table (continued) –
RAFIX 16 - Pushbutton, flush lens, round collar

→ Illumination	Color of lens	Order no. complete	Order no. single parts	
			Housing	Lens
yes	transparent red	1.30.070.021/1306	1.30.070.521/0000	5.49.259.017/1306
yes	transparent yellow	1.30.070.021/1403	1.30.070.521/0000	5.49.259.017/1403
yes	transparent green	1.30.070.021/1505	1.30.070.521/0000	5.49.259.017/1505
yes	transparent blue	1.30.070.021/1607	1.30.070.521/0000	5.49.259.017/1607
yes	transparent colorless	1.30.070.021/1002	1.30.070.521/0000	5.49.259.017/1002
no	opaque red	1.30.070.271/0300	1.30.070.521/0000	5.49.259.017/0313
no	opaque yellow	1.30.070.271/0400	1.30.070.521/0000	5.49.259.017/0410
no	opaque green	1.30.070.271/0500	1.30.070.521/0000	5.49.259.017/0500
no	opaque blue	1.30.070.271/0600	1.30.070.521/0000	5.49.259.017/0612
no	opaque white	1.30.070.271/0200	1.30.070.521/0000	5.49.259.017/0200
no	opaque black	1.30.070.271/0100	1.30.070.521/0000	5.49.259.017/0104

For the „latching“ function, please use the standard contact block with „latching“ function.

Accessoires:

Legend insert, blank, use only for transparent lenses: 5.70.637.000/2000
RAFIX 16 - Label holder, flush, for round collar: see page 2 - 80

RAFIX 16 Pushbutton IP66 with protective cap

Technical data see page 2 - 9

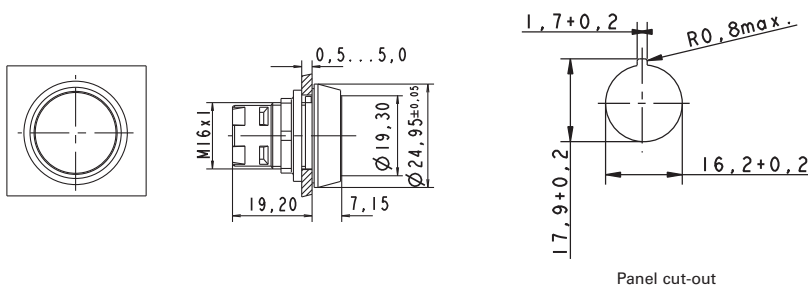

→ Illumination	Color of lens	Order no. complete	Order no. single parts	
			Housing	Lens
yes	transparent red	1.30.070.026/1306	-	-
yes	transparent yellow	1.30.070.026/1403	-	-
yes	transparent green	1.30.070.026/1505	-	-
yes	transparent blue	1.30.070.026/1607	-	-
yes	transparent colorless	1.30.070.026/1002	-	-

CONTROL COMPONENTS

RAFIX 16 - ACTUATORS AND SIGNAL INDICATORS

– Table (continued) –

RAFIX 16 - Pushbutton IP66 with protective cap

Pushbutton for use in hostile environments. A transparent protective cap ensures a degree of protection of IP 66 to DIN EN 60529. Operating life: 500,000 operations.

For the „latching“ function, please use the standard contact block with „latching“ function.

Accessoires:

Legend insert, blank, use only for transparent lenses: 5.70.637.000/2000

RAFIX 16 - Label holder, flush, for round collar: see page 2 - 80



RAFIX 16 Pushbutton, protruding lens, round collar

Technical data see page 2 - 9

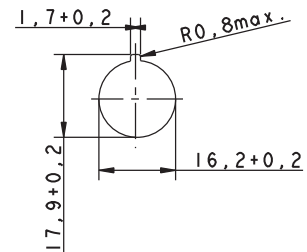
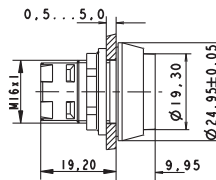
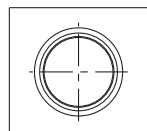

Panel cut-out

→ Illumination	Color of lens	Order no. complete	Order no. single parts	
			Housing	Lens
yes	transparent red	1.30.070.071/1306	1.30.070.571/0000	5.49.259.018/1306
yes	transparent yellow	1.30.070.071/1403	1.30.070.571/0000	5.49.259.018/1403
yes	transparent green	1.30.070.071/1505	1.30.070.571/0000	5.49.259.018/1505
yes	transparent blue	1.30.070.071/1607	1.30.070.571/0000	5.49.259.018/1607
yes	transparent colorless	1.30.070.071/1002	1.30.070.571/0000	5.49.259.018/1002
no	opaque red	1.30.070.321/0300	-	-
no	opaque black	1.30.070.321/0100	-	-

For the „latching“ function, please use the standard contact block with „latching“ function.

Accessoires:

Legend insert, blank, use only for transparent lenses: 5.70.637.000/2000

RAFIX 16 - Label holder, flush, for round collar: see page 2 - 80

RAFIX 16 Pushbutton, protruding collar, round collar

Technical data see page 2 - 9

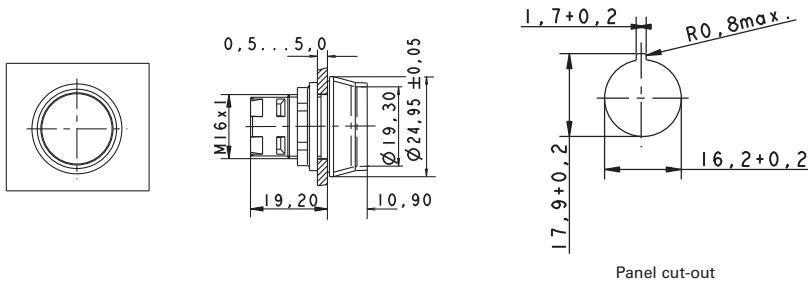

Panel cut-out

→ Illumination	Color of lens	Order no. complete	Order no. single parts	
			Housing	Lens
yes	transparent red	1.30.070.121/1306	1.30.070.621/0000	5.49.259.017/1306
yes	transparent yellow	1.30.070.121/1403	1.30.070.621/0000	5.49.259.017/1403
yes	transparent green	1.30.070.121/1505	1.30.070.621/0000	5.49.259.017/1505
yes	transparent blue	1.30.070.121/1607	1.30.070.621/0000	5.49.259.017/1607
yes	transparent colorless	1.30.070.121/1002	1.30.070.621/0000	5.49.259.017/1002

The protruding collar offers protection against inadvertent operation and thereby fulfils the safety requirements of various machinery manufacturers.

For the „latching“ function, please use the standard contact block with „latching“ function.

Accessoires:

Legend insert, blank, use only for transparent lenses: 5.70.637.000/2000

RAFIX 16 - Label holder, flush, for round collar: see page 2 - 80

RAFIX 16 Pushbutton, flush lens, square collar, alignable without gaps

Technical data see page 2 - 9

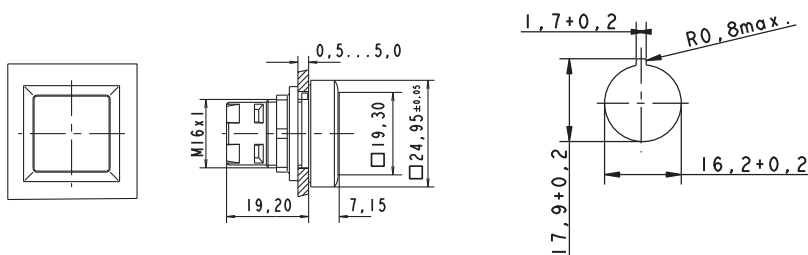

Panel cut-out

CONTROL COMPONENTS

RAFIX 16 - ACTUATORS AND SIGNAL INDICATORS

– Table (continued) –

RAFIX 16 - Pushbutton, flush lens, square collar, alignable without gaps

→ Illumination	Color of lens	Order no. complete	Order no. single parts	
			Housing	Lens
yes	transparent red	1.30.070.201/1306	1.30.070.701/0000	5.49.077.011/1306
yes	transparent yellow	1.30.070.201/1403	1.30.070.701/0000	5.49.077.011/1403
yes	transparent green	1.30.070.201/1505	1.30.070.701/0000	5.49.077.011/1505
yes	transparent blue	1.30.070.201/1607	1.30.070.701/0000	5.49.077.011/1607
yes	transparent colorless	1.30.070.201/1002	1.30.070.701/0000	5.49.077.011/1002
no	opaque red	1.30.070.451/0300	1.30.070.701/0000	5.49.077.011/0313
no	opaque yellow	1.30.070.451/0400	1.30.070.701/0000	5.49.077.011/0410
no	opaque green	1.30.070.451/0500	1.30.070.701/0000	5.49.077.011/0518
no	opaque blue	1.30.070.451/0600	1.30.070.701/0000	5.49.077.011/0612
no	opaque white	1.30.070.451/0200	1.30.070.701/0000	5.49.077.011/0200
no	opaque black	1.30.070.451/0100	1.30.070.701/0000	5.49.077.011/0104

For the „latching“ function, please use the standard contact block with „latching“ function.

Accessoires:

Legend insert, blank, use only for transparent lenses: 5.70.635.000/2000

Protective cover, suitable for lead seal: 5.05.800.055/0000

RAFIX 16 - Label holder, protruding, for square flush fitting collar: see page 2 - 81

RAFIX 16 Selector switches

→ The illuminated selector switches are provided with translucent handle markings. These are opaque on the non-illuminated versions.

Technical Data

→ General information

Actuator	handle
Marking of handle	see order block
Form of collar	see order block

→ Dimensions

Collar dimensions	see order block
Overall height	17.1 mm
Mounting depth	44.7 mm
Mounting hole	16.2 mm
Key grid	25 x 25 mm

→ Mechanical design

Mounting	ring nut
Contact function	see order block
Contact arrangement	according to contact block
Illumination	see order block
Rotating angle	see order block

→ Mechanical characteristics

Torque max.	1.3 Nm
-------------	--------

→ Other specifications

Operating life (operations)	30,000
Degree of protection from front side	IP65 (DIN EN 60529)
Operation temperature min.	-25 °C
Ambient temp. operating max. without lamp /LED	+70 °C
Ambient temp. operating max. with lamp /LED	+55 °C
Storage temperature min.	-40 °C
Storage temperature max.	+85 °C
Environmental resistance	acc. to IEC 60068-2-14, -30, -33 and -78
ROHS compliant	yes
REACH compliant	yes

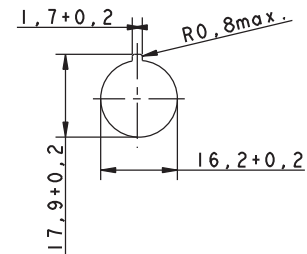

Panel cut-out

Approvals



IEC 61058, 25T70
without lamp,
25T55 with lamp

C22.2 No.
14-M91

Accessories RAFIX 16 - Selector switch

→ Description	Photo	Order no.	Additional accessories see page
RAFIX - Insulating housing, Ø 16.2 mm		-	2 - 78, 5 - 19
RAFIX 16 - Contact blocks with gold contacts		-	2 - 62
RAFIX 16 - Contact blocks with silver contacts		-	2 - 67
Socket W 2 x 4.6d, LED superbright		-	5 - 5
Fixing spanner for hexagon nut		5.58.002.034/0000	2 - 78, 5 - 26

CONTROL COMPONENTS

RAFIX 16 - ACTUATORS AND SIGNAL INDICATORS



RAFIX 16 Selector switch, square collar

Technical data see page 2 - 17

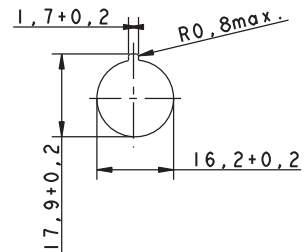
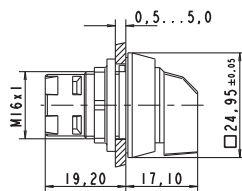
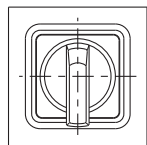

Panel cut-out

2

RAFIX
16

→ Illumination	Contact function	Rotating angle	Marking of handle	Order no.
yes	momentary	1 x 40°		translucent white 1.30.073.551/2000
yes	momentary	2 x 40°		translucent white 1.30.073.651/2000
yes	latching	1 x 90°, form L		translucent white 1.30.073.501/2000
yes	latching	1 x 90°, form V		translucent white 1.30.073.601/2000
yes	latching	2 x 60°		translucent white 1.30.073.701/2000
no	momentary	1 x 40°		opaque white 1.30.073.550/0200
no	momentary	2 x 40°		opaque white 1.30.073.650/0200
no	latching	1 x 90°, form L		opaque white 1.30.073.500/0200
no	latching	1 x 90°, form V		opaque white 1.30.073.600/0200
no	latching	2 x 60°		opaque white 1.30.073.700/0200

Only use contact blocks with „momentary“ contact function.

For versions with clockwise and counterclockwise rotation, use universal contact blocks only!

For colored illumination of the handle marking please use contact block with lamp socket and colored LED W 2 x 4,6d (see chapter 5 accessories).

Accessoires:

RAFIX 16 - Label holder, flush, for square collar: see page 2 - 80

RAFIX 16 Selector switch, round collar

Technical data see page 2 - 17

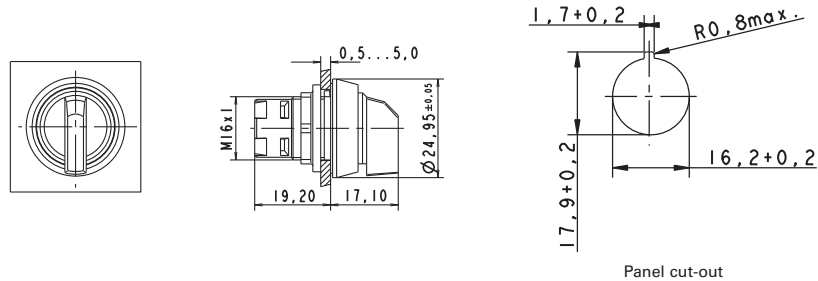

→ Illumination	Contact function	Rotating angle	Marking of handle	Order no.
yes	momentary	1 x 40°		translucent white 1.30.073.571/2000
yes	momentary	2 x 40°		translucent white 1.30.073.671/2000
yes	latching	1 x 90°, form L		translucent white 1.30.073.521/2000
yes	latching	1 x 90°, form V		translucent white 1.30.073.621/2000
yes	latching	2 x 60°		translucent white 1.30.073.721/2000
no	momentary	1 x 40°		opaque white 1.30.073.570/0200
no	momentary	2 x 40°		opaque white 1.30.073.670/0200
no	latching	1 x 90°, form L		opaque white 1.30.073.520/0200
no	latching	1 x 90°, form V		opaque white 1.30.073.620/0200
no	latching	2 x 60°		opaque white 1.30.073.720/0200

Only use contact blocks with „momentary“ contact function.

For versions with clockwise and counterclockwise rotation, use universal contact blocks only!

For colored illumination of the handle marking please use contact block with lamp socket and colored LED W 2 x 4,6d (see chapter 5 accessories).

Accessoires:

RAFIX 16 - Label holder, flush, for round collar: see page 2 - 80

CONTROL COMPONENTS

RAFIX 16 - ACTUATORS AND SIGNAL INDICATORS



RAFIX 16 Selector switch, square collar, alignable without gaps

Technical data see page 2 - 17

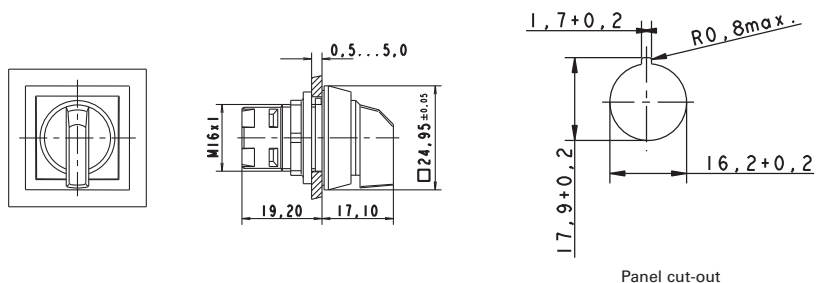

Panel cut-out

→ Illumination	Contact function	Rotating angle	Marking of handle	Order no.
yes	momentary	1 x 40°		translucent white 1.30.073.591/2000
yes	momentary	2 x 40°		translucent white 1.30.073.691/2000
yes	latching	1 x 90°, form L		translucent white 1.30.073.541/2000
yes	latching	1 x 90°, form V		translucent white 1.30.073.641/2000
yes	latching	2 x 60°		translucent white 1.30.073.741/2000
no	momentary	1 x 40°		opaque white 1.30.073.590/0200
no	momentary	2 x 40°		opaque white 1.30.073.690/0200
no	latching	1 x 90°, form L		opaque white 1.30.073.540/0200
no	latching	1 x 90°, form V		opaque white 1.30.073.640/0200
no	latching	2 x 60°		opaque white 1.30.073.740/0200

Only use contact blocks with „momentary“ contact function.

For versions with clockwise and counterclockwise rotation, use universal contact blocks only!

For colored illumination of the handle marking please use contact block with lamp socket and colored LED W 2 x 4,6d (see chapter 5 accessories).

Accessoires:

RAFIX 16 - Label holder, protruding, for square flush fitting collar: see page 2 - 81

RAFIX 16 Keylock switches

→ The locking systems we use are created according to DIN EN 1303 by leading lock manufacturers. They are open, mechanical systems that require occasional maintenance of the machinery or plant operator depending on environmental conditions.

Technical Data

→ General information

Form of collar see order block

→ Dimensions

Collar dimensions see order block
 Overall height 27.95 mm
 Mounting depth 44.7 mm
 Mounting hole 16.2 mm
 Key grid 25 x 25 mm

→ Mechanical design

Mounting ring nut
 Contact function see order block
 Contact arrangement according to contact block
 Illumination no
 Lock Micromec
 Wafers 5
 Lock type 001
 Number of locking positions 500
 Main key on request
 Rotating angle see order block
 Key removal position see order block

→ Mechanical characteristics

Torque max. 1.3 Nm

→ Electrical characteristics

Protection class II

→ Other specifications

ESD-strength lock / contact 15 kV
 ESD strength key/ front panel 8 kV
 Operating life (operations) 65,000
 Degree of protection from front side IP65 (DIN EN 60529)
 Operation temperature min. -25 °C
 Ambient temp. operating max. without lamp /LED +70 °C
 Storage temperature min. -40 °C
 Storage temperature max. +85 °C
 Environmental resistance acc. to IEC 60068-2-14, -30, -33 and -78
 ROHS compliant yes
 REACH compliant yes

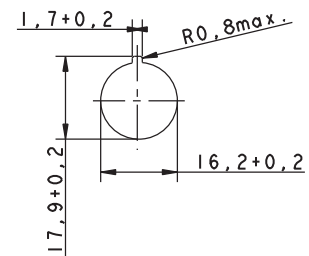

Panel cut-out

Approvals



IEC 61058, 25T70



C22.2 No. 14-M91







Accessories RAFIX 16 - Keylock switch

→ Description	Photo	Order no.	Additional accessories see page
RAFIX - Insulating housing, Ø 16.2 mm		-	2 - 78, 5 - 19
RAFIX 16 - Universal contact block, gold contacts, with quick-connect terminals		-	2 - 65

CONTROL COMPONENTS

RAFIX 16 - ACTUATORS AND SIGNAL INDICATORS

**- Table (continued) -
Accessories RAFIX 16 - Keylock switch**







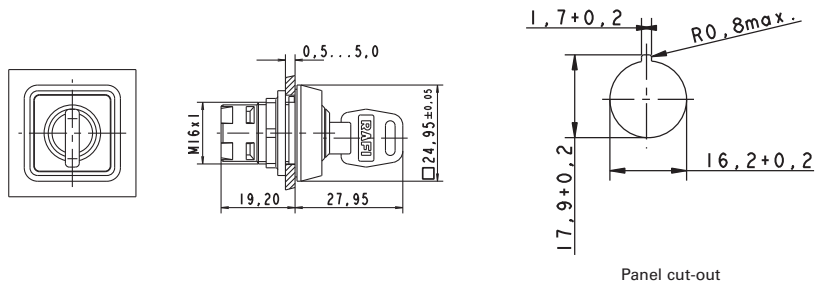

→ Description	Photo	Order no.	Additional accessories see page
RAFIX 16 - Universal contact block, gold contacts, with screw terminals		-	2 - 66
RAFIX 16 - Universal contact block, silver contacts, with quick-connect terminals		-	2 - 70
RAFIX 16 - Universal contact block, silver contacts, with screw terminals		-	2 - 71
Spare key, (delivery content 1 key)		5.58.007.001/0000	-
Spare key, for double action, e.g. 2 x 90° (delivery content 1 key)		5.58.008.001/0000	-



RAFIX 16 Keylock switch, square collar

Technical data see page 2 - 21



→ Contact function	Rotating angle	Key removal position	Order no.
momentary	1 x 40°		1.30.076.501/0000
momentary	2 x 40°		1.30.076.701/0000
latching	1 x 90°, form L		1.30.076.001/0000
latching	1 x 90°, form L		1.30.076.051/0000
latching	1 x 90°, form V		1.30.076.101/0000
latching	1 x 90°, form V		1.30.076.151/0000
latching	2 x 90°		1.30.076.301/0000
latching	2 x 90°		1.30.076.401/0000

– Table (continued) –
RAFIX 16 - Keylock switch, square collar

Only use contact blocks with „momentary“ contact function. For versions with clockwise and counterclockwise rotation, use universal contact block only.

Other contact functions on request.

Included: 2 keys

Accessoires:

RAFIX 16 - Label holder, flush, for square collar: see page 2 - 80

RAFIX 16 Keylock switch, round collar

Technical data see page 2 - 21

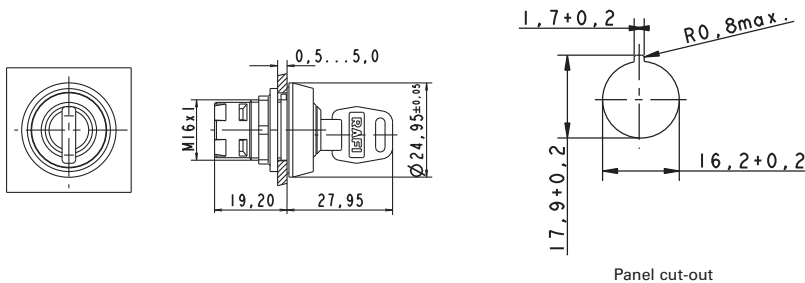

Panel cut-out



→ Contact function	Rotating angle		Key removal position	Order no.
momentary	1 x 40°		0	1.30.076.521/0000
momentary	2 x 40°		0	1.30.076.721/0000
latching	1 x 90°, form L		0	1.30.076.021/0000
latching	1 x 90°, form L		0+1	1.30.076.071/0000
latching	1 x 90°, form V		0	1.30.076.121/0000
latching	1 x 90°, form V		0+1	1.30.076.171/0000
latching	2 x 90°		0	1.30.076.321/0000
latching	2 x 90°		0+1+2	1.30.076.421/0000

Only use contact blocks with „momentary“ contact function. For versions with clockwise and counterclockwise rotation, use universal contact block only.

Other contact functions on request.

Included: 2 keys

Accessoires:

RAFIX 16 - Label holder, flush, for round collar: see page 2 - 80

CONTROL COMPONENTS

RAFIX 16 - ACTUATORS AND SIGNAL INDICATORS



RAFIX 16 Keylock switch, square collar, alignable without gaps

Technical data see page 2 - 21

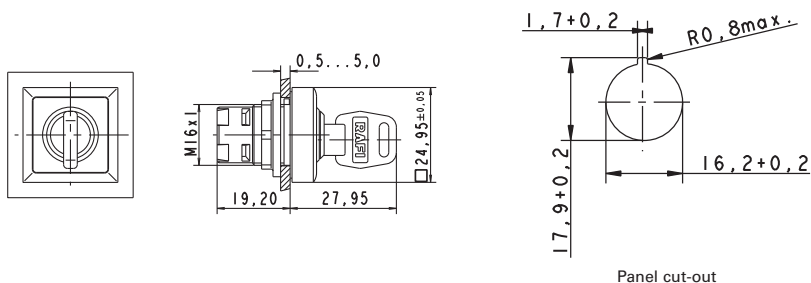

Panel cut-out

→ Contact function	Rotating angle		Key removal position	Order no.
momentary	1 x 40°		0	1.30.076.541/0000
momentary	2 x 40°		0	1.30.076.741/0000
latching	1 x 90°, form L		0	1.30.076.041/0000
latching	1 x 90°, form L		0+1	1.30.076.091/0000
latching	1 x 90°, form V		0	1.30.076.141/0000
latching	1 x 90°, form V		0+1	1.30.076.191/0000
latching	2 x 90°		0	1.30.076.341/0000
latching	2 x 90°		0+1+2	1.30.076.441/0000

Only use contact blocks with „momentary“ contact function. For versions with clockwise and counterclockwise rotation, use universal contact block only.

Other contact functions on request.

Included: 2 keys

Accessoires:

RAFIX 16 - Label holder, protruding, for square flush fitting collar: see page 2 - 81

RAFIX 16 Mushroom-headed pushbuttons

Technical Data

→ General information	
Actuator	mushroom
Color of mushroom	see order block
Form of collar	see order block
→ Dimensions	
Collar dimensions	see order block
Overall height	12.1 mm
Mounting depth	44.7 mm
Mounting hole	16.2 mm
Key grid	25 x 25 mm
→ Mechanical design	
Mounting	ring nut
Contact function	according to contact block
Contact arrangement	according to contact block
Illumination	no
→ Mechanical characteristics	
Operating travel	3 mm
Robustness max.	100 Nm
→ Other specifications	
Operating life (operations)	2,000,000
Degree of protection from front side	IP65 (DIN EN 60529)
Operation temperature min.	-25 °C
Ambient temp. operating max. without lamp /LED	+70 °C
Storage temperature min.	-40 °C
Storage temperature max.	+85 °C
Environmental resistance	acc. to IEC 60068-2-14, -30, -33 and -78
ROHS compliant	yes
REACH compliant	yes

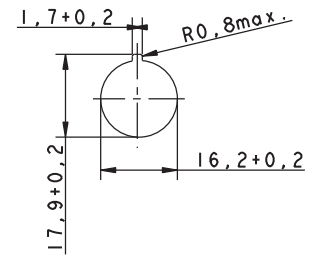

Panel cut-out

Approvals



IEC 61058, 25T70



C22.2 No. 14-M91



Accessories RAFIX 16 - Mushroom-headed pushbutton

Description	Photo	Order no.	Additional accessories see page
RAFIX - Insulating housing, Ø 16.2 mm		-	2 - 78, 5 - 19
RAFIX 16 - Contact blocks with gold contacts		-	2 - 62
RAFIX 16 - Contact blocks with silver contacts		-	2 - 67
RAFIX 16 - Label holder, flush, for round collar		-	2 - 80
Fixing spanner for hexagon nut		5.58.002.034/0000	2 - 78, 5 - 26

CONTROL COMPONENTS

RAFIX 16 - ACTUATORS AND SIGNAL INDICATORS



RAFIX 16 Mushroom-headed pushbutton, round collar

Technical data see page 2 - 25

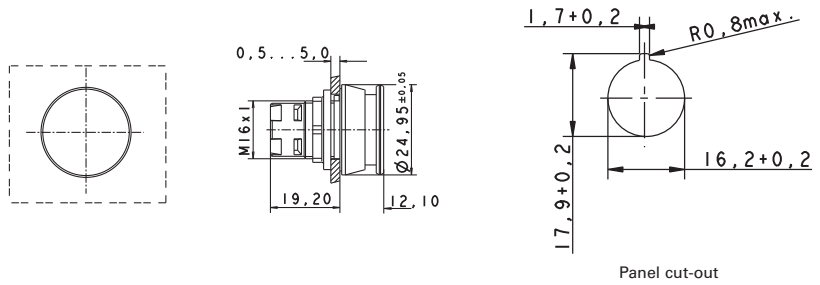

Panel cut-out

→ Illumination	Color of mushroom	Order no.
no	opaque red	1.30.071.021/0300
no	opaque black	1.30.071.021/0100

For the „latching“ function, please use the standard contact block with „latching“ function.

2

RAFIX
16

RAFIX 16 Emergency stop pushbuttons

→ Original operating instructions see Appendix.

Technical Data

→ General information

Actuator	mushroom
Color of mushroom	see order block
Form of collar	see order block

→ Dimensions

Collar dimensions	see order block
Overall height	see order block
Mounting depth	44.7 mm
Mounting hole	16.2 mm

→ Mechanical design

Mounting	ring nut
Contact function	latching
Contact arrangement	according to contact block
Illumination	see order block
Reset	counterclockwise or clockwise rotation

→ Mechanical characteristics

Robustness max.	100 N
Robustness	acc. to IEC 60947-5-5

→ Other specifications

Operating life (operations)	30,000
Degree of protection from front side	IP65 (DIN EN 60529)
Operation temperature min.	-25 °C
Ambient temp. operating max. without lamp /LED	+70 °C
Ambient temp. operating max. with lamp /LED	+55 °C
Storage temperature min.	-40 °C
Storage temperature max.	+85 °C
Environmental resistance	acc. to IEC 60068-2-14, -30, -33 and -78
Corresponding to CE Ma-Dir. 89/392	yes
Dupe-proof acc. to DIN EN ISO 13850	see order block
ROHS compliant	yes
REACH compliant	yes

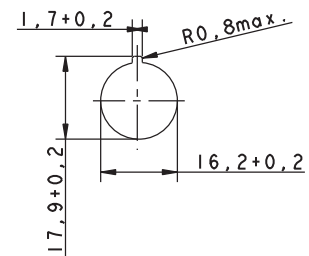

Panel cut-out

Approvals



IEC 61058, 25T70
without lamp,
25T55 with lamp

C22.2 No.
14-M91





Accessories RAFIX 16 - Emergency stop pushbutton

→ Description	Photo	Order no.	Additional accessories see page
Emergency stop label, PVC adhesive, Ø 16.3 mm		-	2 - 81, 5 - 21
RAFIX - Insulating housing, Ø 16.2 mm		-	2 - 78, 5 - 19
RAFIX 16 - Universal contact block with coupling monitoring, silver contacts, with quick-connect terminals		-	2 - 71
RAFIX 16 - Universal contact block, gold contacts, with quick-connect terminals		-	2 - 65

CONTROL COMPONENTS

RAFIX 16 - ACTUATORS AND SIGNAL INDICATORS

– Table (continued) –
Accessories RAFIX 16 - Emergency stop pushbutton

→ Description	Photo	Order no.	Additional accessories see page
RAFIX 16 - Universal contact block, gold contacts, with screw terminals		-	2 - 66
RAFIX 16 - Universal contact block, silver contacts, with quick-connect terminals		-	2 - 70
RAFIX 16 - Universal contact block, silver contacts, with screw terminals		-	2 - 71
Fixing spanner for hexagon nut		5.58.002.034/0000	2 - 78, 5 - 26



RAFIX 16 Emergency stop pushbutton, round collar, dupe-proof, non-blocking

Technical data see page 2 - 27

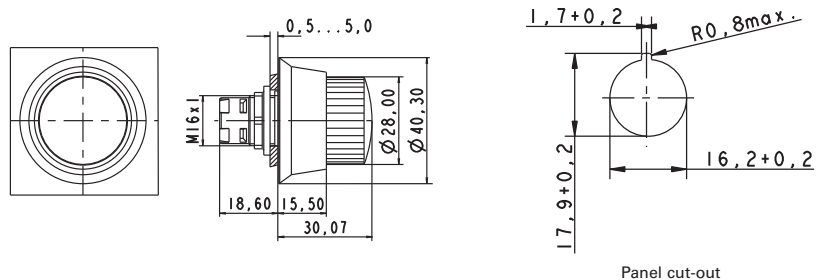

→ Illumination	Color of mushroom	Order no.
no	opaque red, collar yellow	1.30.074.821/0000

Only use universal contact blocks.

The positively driven mechanical arrangement is dupe-proof to DIN EN ISO 13850.

Special shape prevents blocking: Actuation cannot be interrupted by any jamming objects.

RAFIX 16 Emergency stop pushbutton, round collar, conical, dupe-proof, non-blocking

Technical data see page 2 - 27

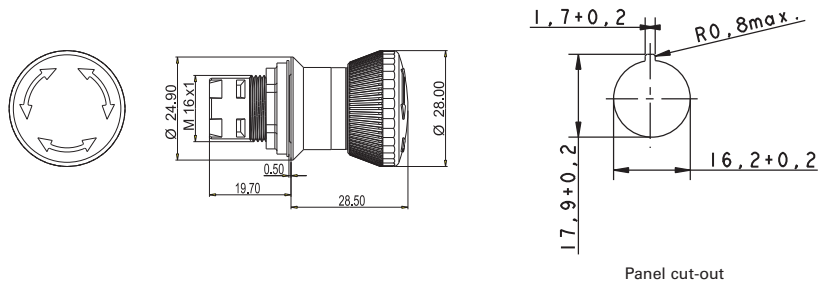

→ Illumination	Color of mushroom	Order no.
no	opaque red	1.30.074.281/0300

Only use universal contact blocks.

The positively driven mechanical arrangement is dupe-proof to DIN EN ISO 13850.

CONTROL COMPONENTS

RAFIX 16 - ACTUATORS AND SIGNAL INDICATORS

2

RAFIX
16

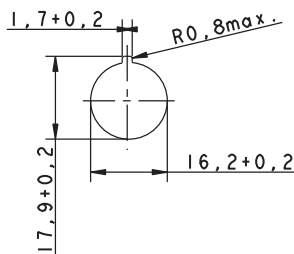

Panel cut-out

Approvals



IEC 61058, 25T70



C22.2 No.
14-M91



RAFIX 16 Toggle switches

Technical Data

→ General information

Form of collar see order block

→ Dimensions

Collar dimensions see order block
Overall height 18.4 mm
Mounting depth 44.7 mm
Mounting hole 16.2 mm
Key grid 25 x 25 mm

→ Mechanical design

Mounting ring nut
Contact function latching
Contact arrangement according to contact block
Illumination no

→ Mechanical characteristics

Robustness max. 100 N

→ Other specifications

Degree of protection from front side IP65 (DIN EN 60529)
Operation temperature min. -25 °C
Ambient temp. operating max. without lamp /LED +70 °C
Ambient temp. operating max. with lamp /LED +55 °C
Storage temperature min. -40 °C
Storage temperature max. +85 °C
Environmental resistance acc. to IEC 60068-2-14, -30, -33 and -78
Operating life (operations) 300,000
ROHS compliant yes
REACH compliant yes

Accessories RAFIX 16 - Toggle switch

→ Description

Photo

Order no.

Additional accessories see page

RAFIX 16 - Standard contact block, 1 NC + 1 NO, momentary, silver contacts, without lamp socket



1.20.122.021/0000

2 - 68

RAFIX 16 - Standard contact block, 1 NC + 1 NO, momentary, gold contacts, without lamp socket



1.20.122.031/0000

2 - 63

RAFIX 16 - Standard contact block, silver contacts, without lamp socket, screw terminals



1.20.122.121/0000

2 - 69

RAFIX 16 - Standard contact block, gold contacts, without lamp socket, screw terminals



1.20.122.131/0000

2 - 64

Label holder, flush, for square collar



5.07620.004/0000

2 - 80

Fixing spanner for hexagon nut



5.58.002.034/0000

2 - 78, 5 - 26

For other contact blocks, refer to the chapter „RAFIX 16 contact blocks“; for additional accessories, refer to the chapter „RAFIX 16 special accessories“.

RAFIX 16 Toggle switch, square collar

Technical data see page 2 - 30

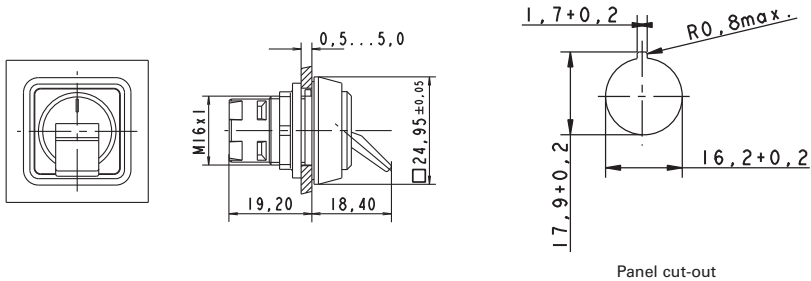

→ Contact function	Illumination	Order no.
latching	no	1.30.075.001/0104

Only use contact blocks with „momentary“ contact function.

RAFIX 16 Toggle switch, round collar

Technical data see page 2 - 30

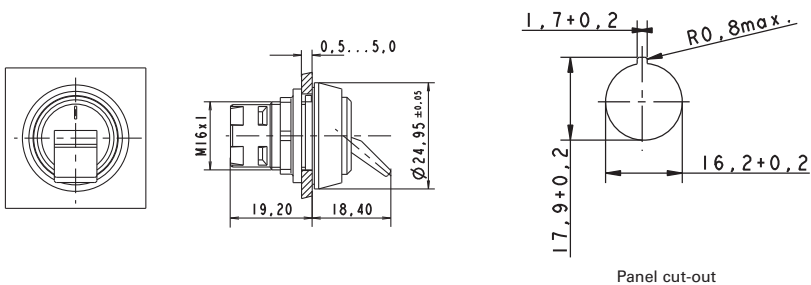

→ Contact function	Illumination	Order no.
latching	no	1.30.075.021/0104

Only use contact blocks with „momentary“ contact function.

CONTROL COMPONENTS

RAFIX 16 - ACTUATORS AND SIGNAL INDICATORS



RAFIX 16 Toggle switch, square collar, alignable without gaps

Technical data see page 2 - 30

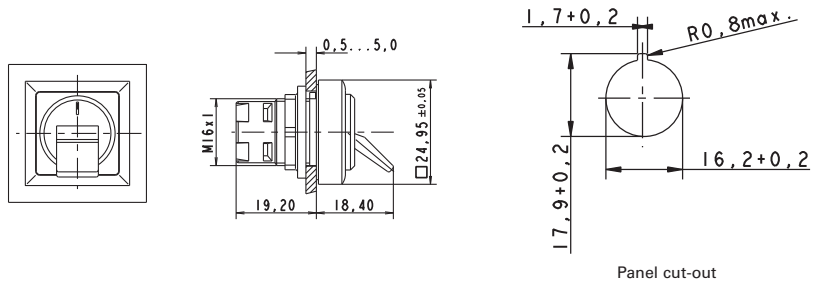

Panel cut-out

→ Contact function	Illumination	Order no.
latching	no	1.30.075.041/0104

Only use contact blocks with „momentary“ contact function.

2

RAFIX
16

RAFIX 16 Potentiometer drives

- To operate potentiometers with a shaft diameter of 6 mm.
Suitable for potentiometers to DIN 41 450 with a shaft length of 32 mm.
Potentiometer not included.

Technical Data

→ General information

Form of lens	handle
Color of handle	black
Form of collar	see order block

→ Dimensions

Collar dimensions	see order block
Overall height	23.65 mm
Mounting depth	19.2 mm
Mounting hole	16.2 mm
Key grid	25 x 25 mm

→ Mechanical design

Mounting	ring nut
Thread nut	M10 x 0,75

→ Other specifications

Degree of protection from front side	IP65 (DIN EN 60529)
Operation temperature min.	-25 °C
Ambient temp. operating max.	+70 °C
Storage temperature min.	-40 °C
Storage temperature max.	+85 °C
Environmental resistance	acc. to IEC 60068-2-14, -30, -33 and -78
ROHS compliant	yes
REACH compliant	yes

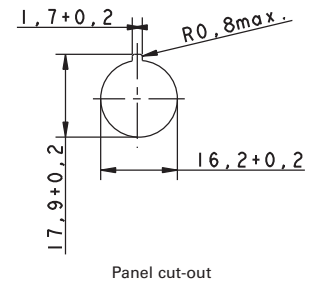

2

RAFIX
16

Accessories RAFIX 16 - Potentiometer drive

→ Description

Description	Photo	Order no.	Additional accessories see page
Fixing spanner for hexagon nut		5.58.002.034/0000	2 - 78, 5 - 26

CONTROL COMPONENTS

RAFIX 16 - ACTUATORS AND SIGNAL INDICATORS



RAFIX 16 Potentiometer drive, square collar

Technical data see page 2 - 33

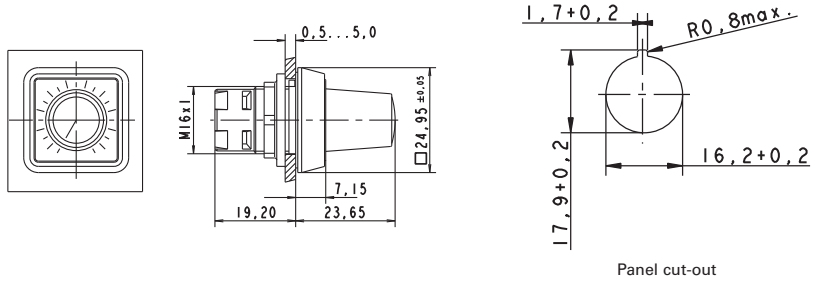

Panel cut-out

→ Form of lens	Form of collar	Color of handle	Order no.
handle	square	black	1.30.077.001/0000

2

RAFIX
16

Accessoires:

RAFIX 16 - Label holder, flush, for square collar: see page 2 - 80



RAFIX 16 Potentiometer drive, round collar

Technical data see page 2 - 33

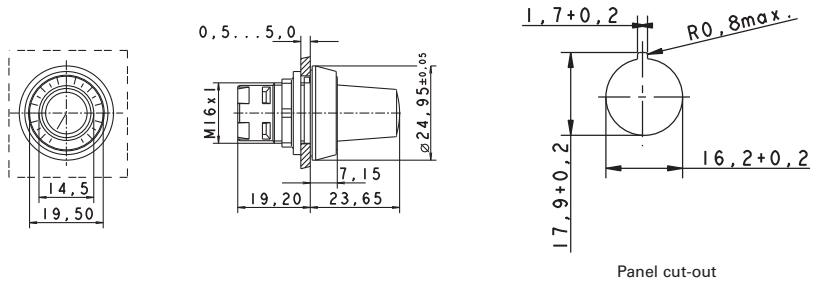

Panel cut-out

→ Form of lens	Form of collar	Color of handle	Order no.
handle	round	black	1.30.077.021/0000

Accessoires:

RAFIX 16 - Label holder, flush, for round collar: see page 2 - 80

RAFIX 16 Potentiometer drive, square collar, alignable without gaps

Technical data see page 2 - 33

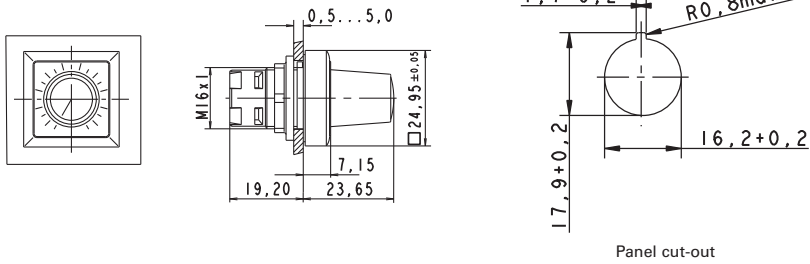

→ Form of lens	Form of collar	Color of handle	Order no.
handle	square alignable	black	1.30.077.041/0000

Accessoires:

RAFIX 16 - Label holder, protruding, for square flush fitting collar: see page 2 - 81

CONTROL COMPONENTS

RAFIX 16 - ACTUATORS AND SIGNAL INDICATORS

2

RAFIX
16

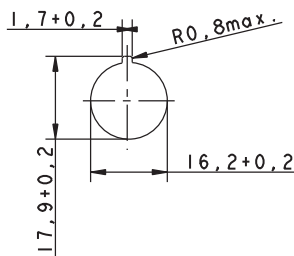

Panel cut-out

RAFIX 16 Buzzers

Technical Data

→ General information

Form of lens	flat lens
Color of lens	opaque black
Form of collar	see order block
Sound	see order block

→ Dimensions

Collar dimensions	see order block
Overall height	6.95 mm
Mounting depth	30.5 mm
Mounting hole	16.2 mm
Key grid	25 x 25 mm

→ Mechanical design

Mounting	ring nut
----------	----------

→ Electrical characteristics

Operating voltage DC	24 V
Input current	see order block

→ Acoustic characteristics

Sonic pressure, 1 m distance min.	see order block
Sound frequency	2400 - 3100 Hz

→ Other specifications

Degree of protection from front side	IP65 (DIN EN 60529)
Operation temperature min.	-25 °C
Ambient temp. operating max.	+70 °C
Storage temperature min.	-40 °C
Storage temperature max.	+85 °C
Environmental resistance	acc. to IEC 60068-2-14, -30, -33 and -78
ROHS compliant	yes
REACH compliant	yes

Accessories RAFIX 16 - Buzzer

→ Description

Fixing spanner for hexagon nut

Photo



Order no.

5.58.002.034/0000

Additional accessories see page

2 - 78, 5 - 26

RAFIX 16 Buzzer, square collar

Technical data see page 2 - 36

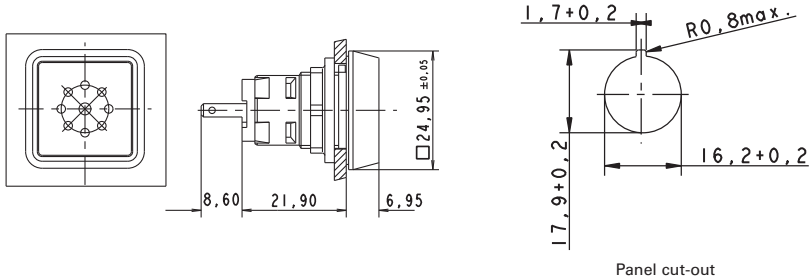

Panel cut-out

→ Operating voltage DC	Input current	Sound	Sonic pressure, 1 m distance min.	Order no.
24 V	25 mA	continuos beep	70 dB	1.30.078.001/0100

12 V DC available on request.

Accessoires:

RAFIX 16 - Label holder, flush, for square collar: see page 2 - 80

2

RAFIX
16

RAFIX 16 Buzzer, round collar

Technical data see page 2 - 36

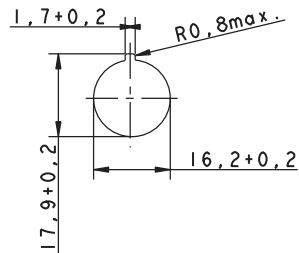
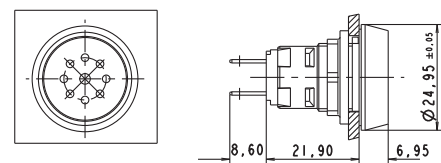

Panel cut-out



→ Operating voltage DC	Input current	Sound	Sonic pressure, 1 m distance min.	Order no.
24 V	25 mA	continuos beep	70 dB	1.30.078.021/0100

12 V DC available on request.

Accessoires:

RAFIX 16 - Label holder, flush, for round collar: see page 2 - 80

CONTROL COMPONENTS

RAFIX 16 - ACTUATORS AND SIGNAL INDICATORS



RAFIX 16 Buzzer, square collar, alignable without gaps

Technical data see page 2 - 36

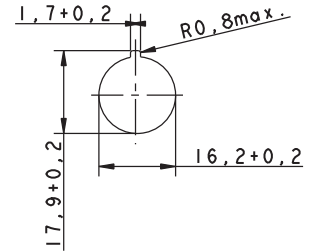
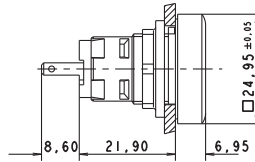
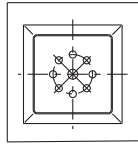

Panel cut-out

→ Operating voltage DC	Input current	Sound	Sonic pressure, 1 m distance min.	Order no.
24 V	25 mA	continuous beep	70 dB	1.30.078.041/0100

12 V DC available on request.

Accessoires:

RAFIX 16 - Label holder, protruding, for square flush fitting collar: see page 2 - 81

2

RAFIX
16

RAFIX 16 Signal indicators

Technical Data

→ General information

Form of lens	see order block
Color of lens	see order block
Form of collar	see order block

→ Dimensions

Collar dimensions	see order block
Overall height	see order block
Mounting depth	30.5 / 44.7 mm
Mounting hole	16.2 mm
Key grid	25 x 25 mm

→ Mechanical design

Mounting	ring nut
----------	----------

→ Other specifications

Degree of protection from front side	IP65 (DIN EN 60529)
Operation temperature min.	-25 °C
Ambient temp. operating max. without lamp /LED	+70 °C
Ambient temp. operating max. with lamp /LED	+55 °C
Storage temperature min.	-40 °C
Storage temperature max.	+85 °C
Environmental resistance	acc. to IEC 60068-2-14, -30, -33 and -78
ROHS compliant	yes
REACH compliant	yes

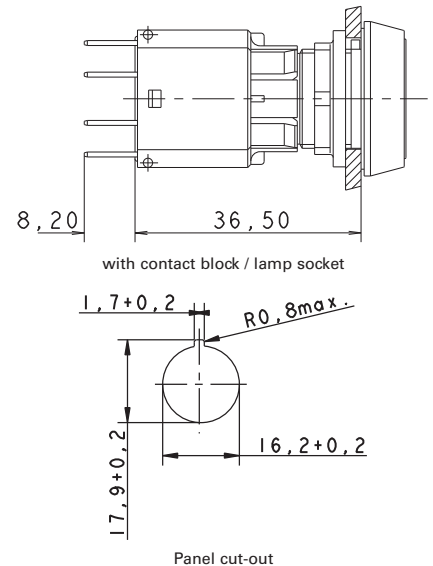

2

RAFIX
16

Approvals



IEC 61058, 25T55







C22.2 No.
14-M91



Accessories RAFIX 16 - Signal indicator

→ Description

Description	Photo	Order no.	Additional accessories see page
RAFIX - Insulating housing, Ø 16.2 mm		-	2 - 78, 5 - 19
RAFIX 16 - Lamp socket		-	2 - 73
Socket W 2 x 4.6d, LED superbright		-	5 - 5
Fixing spanner for hexagon nut		5.58.002.034/0000	2 - 78, 5 - 26

CONTROL COMPONENTS

RAFIX 16 - ACTUATORS AND SIGNAL INDICATORS



RAFIX 16 Signal indicator, square lens

Technical data see page 2 - 39

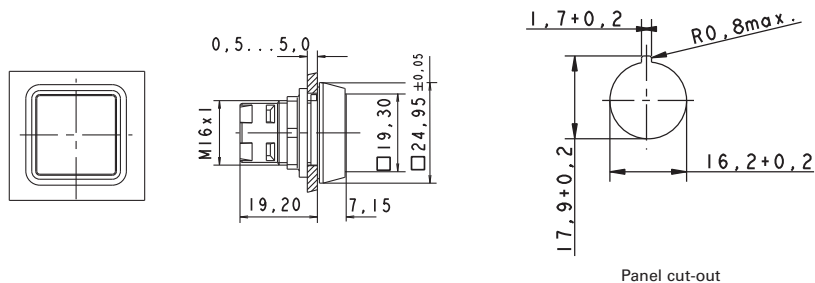

2

RAFIX
16

→ Form of lens	Color of lens	Order no. complete	Order no. single parts	
			Housing	Lens
lens square	transparent red	1.65.124.001/1306	1.65.124.101/0000	5.49.263.006/1306
lens square	transparent yellow	1.65.124.001/1403	1.65.124.101/0000	5.49.263.006/1403
lens square	transparent green	1.65.124.001/1505	1.65.124.101/0000	5.49.263.006/1505
lens square	transparent blue	1.65.124.001/1607	1.65.124.101/0000	5.49.263.006/1607
lens square	transparent colorless	1.65.124.001/1002	1.65.124.101/0000	5.49.263.006/1002

Legending can only be made externally on a label holder.



RAFIX 16 Signal indicator, square collar, flush lens

Technical data see page 2 - 39

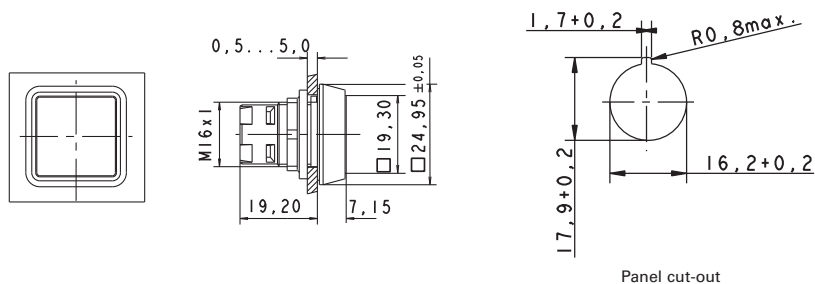

→ Form of lens	Color of lens	Order no. complete	Order no. single parts	
			Housing	Lens
flat lens	transparent red	1.65.124.301/1306	1.65.124.401/0000	5.49.077.011/1306
flat lens	transparent yellow	1.65.124.301/1403	1.65.124.401/0000	5.49.077.011/1403
flat lens	transparent green	1.65.124.301/1505	1.65.124.401/0000	5.49.077.011/1505
flat lens	transparent blue	1.65.124.301/1607	1.65.124.401/0000	5.49.077.011/1607
flat lens	transparent colorless	1.65.124.301/1002	1.65.124.401/0000	5.49.077.011/1002

– Table (continued) –

RAFIX 16 - Signal indicator, square collar, flush lens

Accessoires:

Legend insert, blank, use only for transparent lenses: 5.70.635.000/2000

RAFIX 16 Signal indicator, round lens

Technical data see page 2 - 39

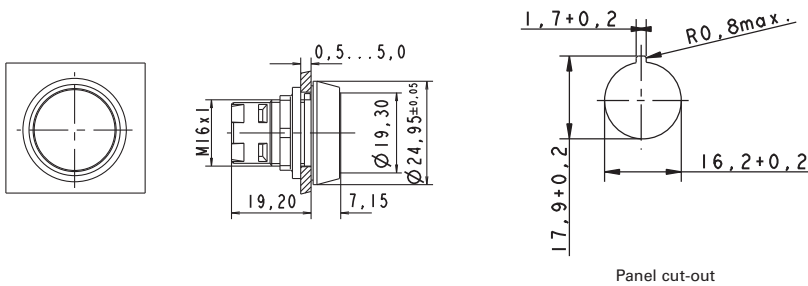

2

RAFIX
16

→ Form of lens	Color of lens	Order no. complete	Order no. single parts	
			Housing	Lens
lens round	transparent red	1.65.124.021/1306	1.65.124.101/0000	5.49.263.007/1306
lens round	transparent yellow	1.65.124.021/1403	1.65.124.101/0000	5.49.263.007/1403
lens round	transparent green	1.65.124.021/1505	1.65.124.101/0000	5.49.263.007/1505
lens round	transparent colorless	1.65.124.021/1002	1.65.124.101/0000	5.49.263.007/1002

Legending can only be made externally on a label holder.

CONTROL COMPONENTS

RAFIX 16 F - GENERAL INFORMATION



RAFIX 16 is a complete control component series with low profile design.

Actuators RAFIX 16 F

- Panel cut-out \varnothing 22.3 mm to IEC 60 947-5-1
- Panel cut-out \square 23.1 mm

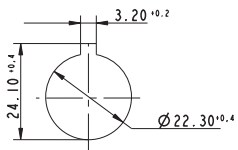

RAFIX 16 F round

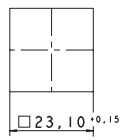

RAFIX 16 F square

- Locating lug.
The locating lug can be easily removed using a screwdriver.
- Degree of protection IP65 on panel
- Grid spacing 30 x 30 mm, round lens
- Grid spacing 25 x 25 mm, square lens
- Low profile, only 1.7 mm in front of the front panel
- Thickness of front panel 0.5 ... 3.5 mm
- Fixing with hexagon nut
- Fixing torque 1.2 Nm max.

Contact blocks RAFIX 16

- Contact block standard: for actuators with one-way operation
 - latching function
 - momentary function
- Contact block universal: for E-stop pushbuttons and for actuators with two-way operation, e. g. selector or keylock switches
 - momentary function

Contact material

- Silver contacts for mains voltage
- Gold contacts for electronic circuits

Illumination

- LED or wedge base lamp with socket W 2 x 4.6 d

Shock-resistance according to IEC 600 68-2-27

- Shock amplitude: \leq 50 g
- Shock time: 11 ms
- Shock type: half sinusoidal

Environment conditions

- acc. to IEC 600 68-2, -14, -30, -33 and -78

Temperature range

- Operating temperature:
 - non-illuminated: - 25 ... + 70 °C
 - illuminated: - 25 ... + 55 °C
- Storage temperature: - 40 ... + 85 °C



RAFIX 16 F Pushbuttons

→ RAFIX 16 F pushbuttons provide with less than 2 mm height above the front-panel an extremely low-profile design. The versions with square collars can be placed side by side so that a completely closed keyboard survey is possible.

Technical Data

→ General information

Form of lens	see order block
Color of lens	see order block
Form of collar	see order block
Color of collar	see order block

→ Dimensions

Collar dimensions	see order block
Overall height	see order block
Mounting depth with contact block	50 mm
Key grid	see order block
Mounting hole	see order block

→ Mechanical design

Mounting	ring nut
Contact function	je nach Schaltelement
Illumination	see order block

→ Mechanical characteristics

Robustness max.	100 N
-----------------	-------

→ Electrical characteristics

Protection class	see order block
------------------	-----------------

→ Other specifications

Operating life (operations)	2,000,000
Degree of protection from front side	IP65 (DIN EN 60529)
Operation temperature min.	-25 °C
Ambient temp. operating max. without lamp /LED	+70 °C
Ambient temp. operating max. with lamp /LED	+55 °C
Storage temperature min.	-40 °C
Storage temperature max.	+85 °C
Environmental resistance	acc. to IEC 60068-2-14, -30, -33 and -78
ROHS compliant	yes
REACH compliant	yes

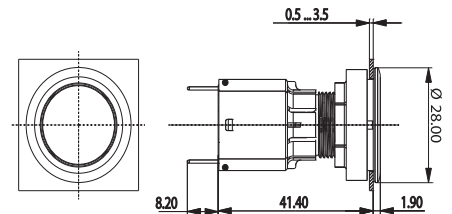

2

RAFIX
16

Approvals



IEC 61058, 25T70
without lamp,
25T55 with lamp

in preparation

Accessories RAFIX 16 F - Pushbutton

Description	Photo	Order no.	Additional accessories see page
RAFIX 16 - Contact blocks with gold contacts		-	2 - 62
RAFIX 16 - Contact blocks with silver contacts		-	2 - 67
Socket W 2 x 4.6d, LED superbright		-	5 - 5
Disassembly tool for LUMOTAST 25, RAFIX 16		5.05.800.042/0000	5 - 27

CONTROL COMPONENTS

RAFIX 16 F - ACTUATORS AND SIGNAL INDICATORS

– Table (continued) –
Accessories RAFIX 16 F - Pushbutton

→ Description	Photo	Order no.	Additional accessories see page
Fixing spanner for hexagon nut		5.58.002.034/0000	2 - 78, 5 - 26



RAFIX 16 F Pushbutton, flush lens, square black collar

Technical data see page 2 - 43

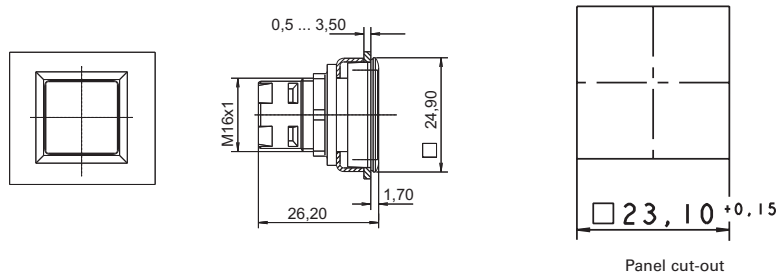

→ Color of collar	Illumination	Color of lens	Order no. complete	Order no. single parts	
				Housing	Lens
black	yes	transparent red	1.30.090.001/1300	1.30.090.501/0000	5.49.077.011/1306
black	yes	transparent yellow	1.30.090.001/1400	1.30.090.501/0000	5.49.077.011/1403
black	yes	transparent green	1.30.090.001/1500	1.30.090.501/0000	5.49.077.011/1505
black	yes	transparent blue	1.30.090.001/1600	1.30.090.501/0000	5.49.077.011/1607
black	yes	transparent colorless	1.30.090.001/1000	1.30.090.501/0000	5.49.077.011/1002
black	no	opaque red	1.30.090.251/0300	-	-
black	no	opaque yellow	1.30.090.251/0400	-	-
black	no	opaque green	1.30.090.251/0500	-	-
black	no	opaque blue	1.30.090.251/0600	-	-
black	no	opaque white	1.30.090.251/0200	-	-
black	no	opaque black	1.30.090.251/0100	-	-

Accessoires:

Legend insert, blank, use only for transparent lenses: 5.70.635.000/2000

RAFIX 16 F Pushbutton, flush lens, round black collar

Technical data see page 2 - 43

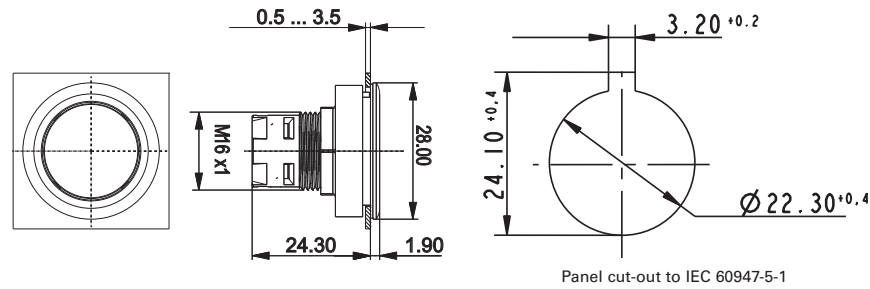

2

→ Color of collar	Illumination	Color of lens	Order no. complete	Order no. single parts	
				Housing	Lens
black	yes	transparent red	1.30.090.011/1300	1.30.090.511/0000	5.49.259.017/1306
black	yes	transparent yellow	1.30.090.011/1400	1.30.090.511/0000	5.49.259.017/1403
black	yes	transparent green	1.30.090.011/1500	1.30.090.511/0000	5.49.259.017/1505
black	yes	transparent blue	1.30.090.011/1600	1.30.090.511/0000	5.49.259.017/1607
black	yes	transparent colorless	1.30.090.011/1000	1.30.090.511/0000	5.49.259.017/1002
black	no	opaque red	1.30.090.261/0300	-	-
black	no	opaque yellow	1.30.090.261/0400	-	-
black	no	opaque green	1.30.090.261/0500	-	-
black	no	opaque blue	1.30.090.261/0600	-	-
black	no	opaque white	1.30.090.261/0200	-	-
black	no	opaque black	1.30.090.261/0100	-	-
black	ring illumination	black	1.30.090.081/0000	-	-

Accessoires:

Legend insert, blank, use only for transparent lenses: 5.70.637.000/2000

RAFIX
16

CONTROL COMPONENTS

RAFIX 16 F - ACTUATORS AND SIGNAL INDICATORS



RAFIX 16 F Pushbutton, flush lens, round metallized collar

Technical data see page 2 - 43

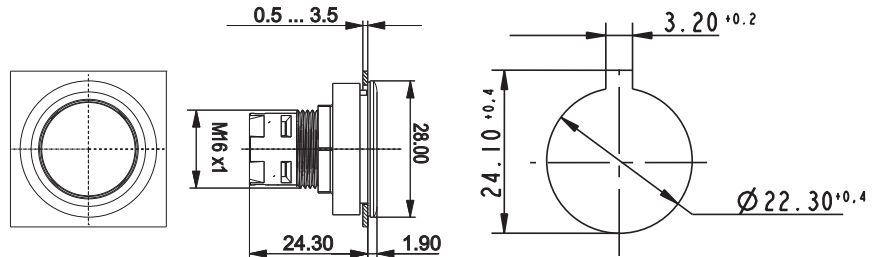

Panel cut-out to IEC 60947-5-1

→ Color of collar	Illumination	Color of lens	Order no. complete	Order no. single parts	
				Housing	Lens
silver metallic	yes	transparent red	1.30.090.012/1300	-	-
silver metallic	yes	transparent yellow	1.30.090.012/1400	-	-
silver metallic	yes	transparent green	1.30.090.012/1500	-	-
silver metallic	yes	transparent blue	1.30.090.012/1600	-	-
silver metallic	yes	transparent colorless	1.30.090.012/1000	-	-
silver metallic	no	opaque red	1.30.090.262/0300	-	-
silver metallic	no	opaque yellow	1.30.090.262/0400	-	-
silver metallic	no	opaque green	1.30.090.262/0500	-	-
silver metallic	no	opaque blue	1.30.090.262/0600	-	-
silver metallic	no	opaque white	1.30.090.262/0200	-	-
silver metallic	no	opaque black	1.30.090.262/0100	-	-
silver metallic	ring illumination	silver-grey	1.30.090.082/0000	-	-

Accessoires:

Legend insert, blank, use only for transparent lenses: 5.70.637.000/2000

2

RAFIX
16

RAFIX 16 F Selector switches

→ The illuminated selector switches are provided with translucent handle markings. These are opaque on the non-illuminated versions.

Technical Data

→ General information

Actuator	handle
Color of handle marking	see order block
Form of collar	see order block
Color of collar	see order block

→ Dimensions

Collar dimensions	see order block
Overall height	12.1 mm
Mounting depth with contact block	50 mm
Key grid	see order block
Mounting hole	see order block

→ Mechanical design

Mounting	ring nut
Contact function	see order block
Illumination	see order block
Rotating angle	see order block

→ Mechanical characteristics

Torque max.	1.3 Nm
-------------	--------

→ Electrical characteristics

Protection class	-
------------------	---

→ Other specifications

Operating life (operations)	30.000
Degree of protection from front side	IP65 (DIN EN 60529)
Operation temperature min.	-25 °C
Ambient temp. operating max. without lamp /LED	+70 °C
Ambient temp. operating max. with lamp /LED	+55 °C
Storage temperature min.	-40 °C
Storage temperature max.	+85 °C
Environmental resistance	acc. to IEC 60068-2-14, -30, -33 and -78
ROHS compliant	yes
REACH compliant	yes

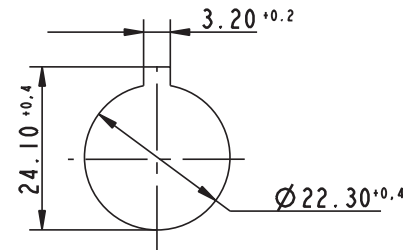

Panel cut-out to IEC 60947-5-1

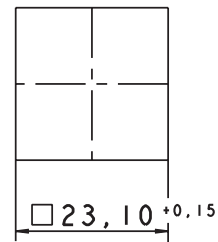

Panel cut-out

Approvals



IEC 61058, 25T70
without lamp,
25T55 with lamp

in preparation



Accessories RAFIX 16 F - Selector switch

Description	Photo	Order no.	Additional accessories see page
RAFIX 16 - Universal contact block with coupling monitoring, silver contacts, with quick-connect terminals		-	2 - 71
RAFIX 16 - Universal contact block, gold contacts, with quick-connect terminals		-	2 - 65
RAFIX 16 - Universal contact block, gold contacts, with screw terminals		-	2 - 66
RAFIX 16 - Universal contact block, silver contacts, with quick-connect terminals		-	2 - 70

CONTROL COMPONENTS

RAFIX 16 F - ACTUATORS AND SIGNAL INDICATORS

– Table (continued) –
Accessories RAFIX 16 F - Selector switch







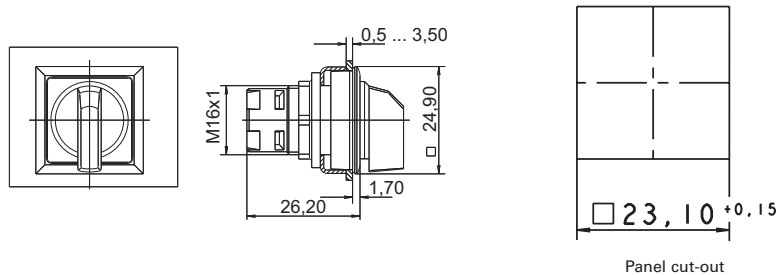

→ Description	Photo	Order no.	Additional accessories see page
RAFIX 16 - Universal contact block, silver contacts, with screw terminals		-	2 - 71
Socket W 2 x 4.6d, LED superbright		-	5 - 5
Fixing spanner for hexagon nut		5.58.002.034/0000	2 - 78, 5 - 26

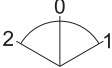

RAFIX 16 F Selector switch, square black collar

Technical data see page 2 - 47



→ Color of collar	Illumination	Contact function	Rotating angle		Color of handle marking	Order no.
black	yes	momentary	1 x 40°		translucent white	1.30.093.551/2000
black	yes	momentary	2 x 40°		translucent white	1.30.093.651/2000
black	yes	latching	1 x 90°, form L		translucent white	1.30.093.501/2000
black	yes	latching	1 x 90°, form V		translucent white	1.30.093.601/2000
black	yes	latching	2 x 60°		translucent white	1.30.093.701/2000
black	no	momentary	1 x 40°		opaque white	1.30.093.550/0200
black	no	momentary	2 x 40°		opaque white	1.30.093.650/0200
black	no	latching	1 x 90°, form L		opaque white	1.30.093.500/0200
black	no	latching	1 x 90°, form V		opaque white	1.30.093.600/0200

2

RAFIX
16

– Table (continued) –
RAFIX 16 F - Selector switch, square black collar

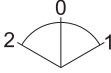
→ Color of collar	Illumination	Contact function	Rotating angle		Color of handle marking	Order no.
black	no	latching	2 x 60°		opaque white	1.30.093.700/0200

Only use RAFIX 16 contact blocks with „momentary“ contact function. For versions with clockwise and counterclockwise rotation, use universal contact blocks only.

For colored illumination of the handle marking please use contact block with lamp socket and colored LED W 2 x 4,6d (see chapter 5 accessories).





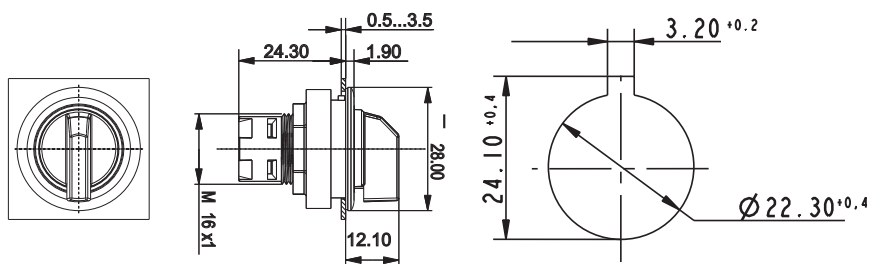



RAFIX 16 F Selector switch, round black collar

Technical data see page 2 - 47

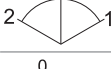

Panel cut-out to IEC 60947-5-1



→ Color of collar	Illumination	Contact function	Rotating angle		Color of handle marking	Order no.
black	yes	momentary	1 x 40°		translucent white	1.30.093.561/2000
black	yes	momentary	2 x 40°		translucent white	1.30.093.661/2000
black	yes	latching	1 x 90°, form L		translucent white	1.30.093.511/2000
black	yes	latching	1 x 90°, form V		translucent white	1.30.093.611/2000
black	yes	latching	2 x 60°		translucent white	1.30.093.711/2000
black	no	momentary	1 x 40°		opaque white	1.30.093.560/0200
black	no	momentary	2 x 40°		opaque white	1.30.093.660/0200
black	no	latching	1 x 90°, form L		opaque white	1.30.093.510/0200
black	no	latching	1 x 90°, form V		opaque white	1.30.093.610/0200

CONTROL COMPONENTS

RAFIX 16 F - ACTUATORS AND SIGNAL INDICATORS

– Table (continued) –
RAFIX 16 F - Selector switch, round black collar

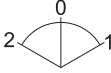
→ Color of collar	Illumination	Contact function	Rotating angle		Color of handle marking	Order no.
black	no	latching	2 x 60°		opaque white	1.30.093.710/0200

Only use RAFIX 16 contact blocks with „momentary“ contact function. For versions with clockwise and counterclockwise rotation, use universal contact blocks only.

For colored illumination of the handle marking please use contact block with lamp socket and colored LED W 2 x 4,6d (see chapter 5 accessories).







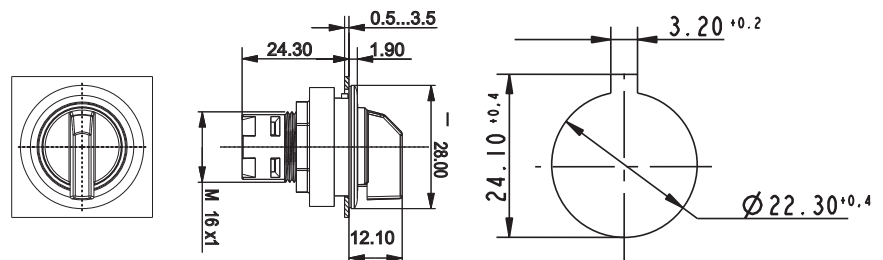



RAFIX 16 F Selector switch, round metallized collar

Technical data see page 2 - 47

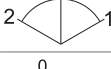

Panel cut-out to IEC 60947-5-1

→ Color of collar	Illumination	Contact function	Rotating angle		Color of handle marking	Order no.
silver metallic	yes	momentary	1 x 40°		translucent white	1.30.093.571/2000
silver metallic	yes	momentary	2 x 40°		translucent white	1.30.093.671/2000
silver metallic	yes	latching	1 x 90°, form L		translucent white	1.30.093.521/2000
silver metallic	yes	latching	1 x 90°, form V		translucent white	1.30.093.621/2000
silver metallic	yes	latching	2 x 60°		translucent white	1.30.093.721/2000
silver metallic	no	momentary	1 x 40°		opaque white	1.30.093.570/0200
silver metallic	no	momentary	2 x 40°		opaque white	1.30.093.670/0200
silver metallic	no	latching	1 x 90°, form L		opaque white	1.30.093.520/0200
silver metallic	no	latching	1 x 90°, form V		opaque white	1.30.093.620/0200

CONTROL COMPONENTS

RAFIX 16 F - ACTUATORS AND SIGNAL INDICATORS

– Table (continued) –
RAFIX 16 F - Selector switch, round metallized collar

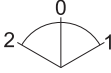
→ Color of collar	Illumination	Contact function	Rotating angle		Color of handle marking	Order no.
silver metallic	no	latching	2 x 60°		opaque white	1.30.093.720/0200

Only use RAFIX 16 contact blocks with „momentary“ contact function. For versions with clockwise and counterclockwise rotation, use universal contact blocks only.

For colored illumination of the handle marking please use contact block with lamp socket and colored LED W 2 x 4,6d (see chapter 5 accessories).

2

RAFIX
16

CONTROL COMPONENTS

RAFIX 16 F - ACTUATORS AND SIGNAL INDICATORS



RAFIX 16 F Keylock switches

→ The locking systems used in our switches are produced in accordance with DIN EN 1303 by leading lock manufacturers. The locking systems in key switches are open mechanical systems, which require occasional maintenance of the machinery or plant operator, according to the ambient conditions.

Technical Data

→ General information

Form of lens	flat lens
Color of lens	opaque black
Form of collar	see order block
	see order block

→ Dimensions

Collar dimensions	see order block
Overall height	24.10 mm
Mounting depth with contact block	50 mm
Key grid	see order block
Mounting hole	see order block

→ Mechanical design

Mounting	ring nut
Contact function	see order block
Illumination	no
Lock	Micromec
Wafers	5
Lock type	001
Number of locking positions	500
Main key	on request
Rotating angle	see order block
Key removal position	see order block

→ Mechanical characteristics

Torque max.	1.3 Nm
-------------	--------

→ Electrical characteristics

Protection class	II
------------------	----

→ Other specifications

Operating life (operations)	65.000
Degree of protection from front side	IP65 (DIN EN 60529)
Operation temperature min.	-25 °C
Ambient temp. operating max. without lamp /LED	+70 °C
Ambient temp. operating max. with lamp /LED	-
Storage temperature min.	-40 °C
Storage temperature max.	+85 °C
Environmental resistance	acc. to IEC 60068-2-14, -30, -33 and -78
Ambient temp. operating max.	+70 °C
ESD-strength lock / contact	15 kV
ESD-strength key/ front panel	4 kV
ROHS compliant	yes
REACH compliant	yes

2

RAFIX
16

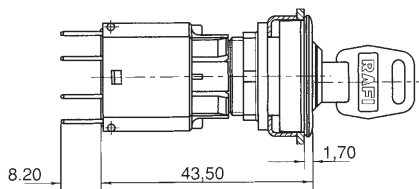

operating element and contact block

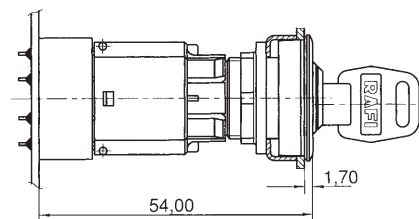

with PCB plug-in socket

Approvals



IEC 61058, 25T70



in preparation



Accessories RAFIX 16 F - Keylock switch

→ Description	Photo	Order no.	Additional accessories see page
RAFIX 16 - Universal contact block with coupling monitoring, silver contacts, with quick-connect terminals		-	2 - 71
RAFIX 16 - Universal contact block, gold contacts, with quick-connect terminals		-	2 - 65
RAFIX 16 - Universal contact block, gold contacts, with screw terminals		-	2 - 66
RAFIX 16 - Universal contact block, silver contacts, with quick-connect terminals		-	2 - 70
RAFIX 16 - Universal contact block, silver contacts, with screw terminals		-	2 - 71
Fixing spanner for hexagon nut		5.58.002.034/0000	2 - 78, 5 - 26
Spare key, (delivery content 1 key)		5.58.007.001/0000	-
Spare key, for double action, e.g. 2 x 90° (delivery content 1 key)		5.58.008.001/0000	-

RAFIX 16 F Keylock switch, square black collar

Technical data see page 2 - 52

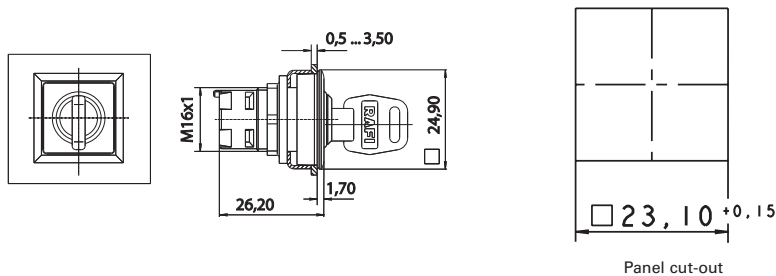

→ 2130_025	Contact function	Rotating angle	Key removal position	Order no.
black	momentary	1 x 40°		1.30.096.501/0000
black	momentary	2 x 40°		1.30.096.701/0000
black	latching	1 x 90°, form L		1.30.096.051/0000
black	latching	1 x 90°, form V		1.30.096.151/0000
black	latching	2 x 90°		1.30.096.401/0000

CONTROL COMPONENTS

RAFIX 16 F - ACTUATORS AND SIGNAL INDICATORS

– Table (continued) –

RAFIX 16 F - Keylock switch, square black collar

Only use RAFIX 16 contact blocks with „momentary“ contact function. For versions with clockwise and counterclockwise rotation, use universal contact blocks only.



RAFIX 16 F Keylock switch, round black collar

Technical data see page 2 - 52

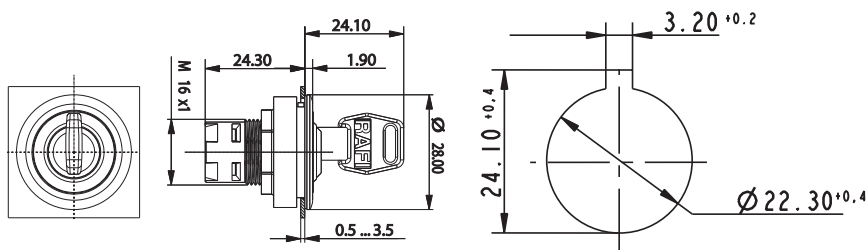

Panel cut-out to IEC 60947-5-1

→ 2130_025	Contact function	Rotating angle	Key removal position	Order no.	
black	momentary	1 x 40°		0	1.30.096.511/0000
black	momentary	2 x 40°		0	1.30.096.711/0000
black	latching	1 x 90°, form L		0+1	1.30.096.061/0000
black	latching	1 x 90°, form V		0+1	1.30.096.161/0000
black	latching	2 x 90°		0+1+2	1.30.096.411/0000

Only use RAFIX 16 contact blocks with „momentary“ contact function. For versions with clockwise and counterclockwise rotation, use universal contact blocks only.

2

RAFIX
16

RAFIX 16 F Keylock switch, round metallized collar

Technical data see page 2 - 52

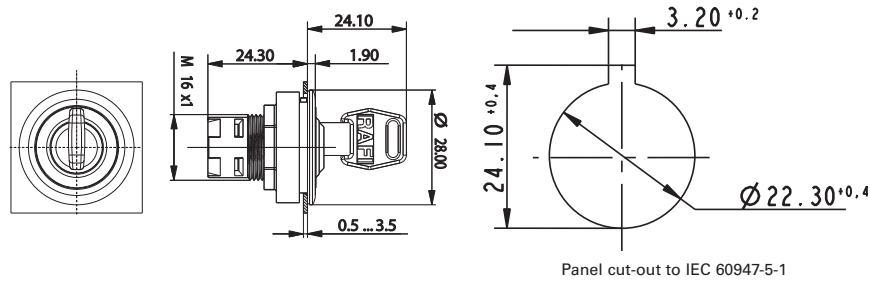

2

→ 2130_025	Contact function	Rotating angle	Key removal position	Order no.
silver metallic	momentary	1 x 40°		0 1.30.096.521/0000
silver metallic	momentary	2 x 40°		0 1.30.096.721/0000
silver metallic	latching	1 x 90°, form L		0+1 1.30.096.071/0000
silver metallic	latching	1 x 90°, form V		0+1 1.30.096.171/0000
silver metallic	latching	2 x 90°		0+1+2 1.30.096.421/0000

Only use RAFIX 16 contact blocks with „momentary“ contact function. For versions with clockwise and counterclockwise rotation, use universal contact blocks only.

RAFIX
16

CONTROL COMPONENTS

RAFIX 16 F - ACTUATORS AND SIGNAL INDICATORS



RAFIX 16 F Emergency stop pushbuttons

→ Original operating instructions see Appendix

Technical Data

→ General information

Actuator	conical mushroom form
Color of mushroom	red, collar yellow
Form of collar	see order block

→ Dimensions

Collar dimensions	see order block
Key grid	see order block
Overall height	24.10 mm
Mounting depth with contact block	50 mm
Key grid	see order block
Mounting hole	see order block

→ Mechanical design

Mounting	ring nut
Contact function	latching
Illumination	no
Rest	clockwise or counterclockwise rotation

→ Mechanical characteristics

Robustness max.	100 N
-----------------	-------

→ Electrical characteristics

Protection class	see order block
------------------	-----------------

→ Other specifications

Operating life (operations)	10,000
Degree of protection from front side	IP65 (DIN EN 60529)
Operation temperature min.	-25 °C
Ambient temp. operating max. without lamp /LED	+70 °C
Ambient temp. operating max. with lamp /LED	-
Storage temperature min.	-40 °C
Storage temperature max.	+85 °C
Environmental resistance	acc. to IEC 60068-2-14, -30, -33 and -78
ROHS compliant	yes
REACH compliant	yes

Approvals



IEC 61058, 25T70



in preparation



2

RAFIX
16

Accessories RAFIX 16 F - Emergency stop pushbutton

→ Description	Photo	Order no.	Additional accessories see page
RAFIX 16 - Universal contact block with coupling monitoring, silver contacts, with quick-connect terminals		-	2 - 71
RAFIX 16 - Universal contact block, gold contacts, with quick-connect terminals		-	2 - 65
RAFIX 16 - Universal contact block, gold contacts, with screw terminals		-	2 - 66
RAFIX 16 - Universal contact block, silver contacts, with quick-connect terminals		-	2 - 70

– Table (continued) –
Accessories RAFIX 16 F - Emergency stop pushbutton

→ Description	Photo	Order no.	Additional accessories see page
RAFIX 16 - Universal contact block, silver contacts, with screw terminals		-	2 - 71
Fixing spanner for hexagon nut		5.58.002.034/0000	2 - 78, 5 - 26

RAFIX 16 F Emergency stop pushbutton, square collar

Technical data see page 2 - 56

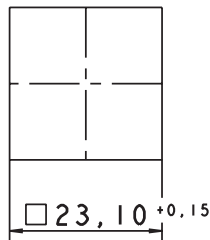
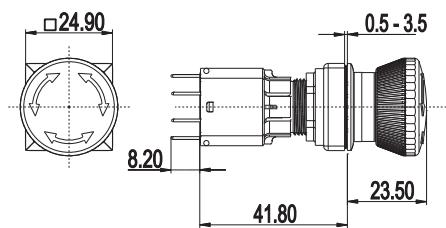

Panel cut-out



→ Contact function	Illumination	Color of mushroom	Mounting hole	Order no.
latching	no	red, collar yellow	23.1 x 23.1 mm	1.30.094.001/0300

Only use universal contact blocks.

CONTROL COMPONENTS

RAFIX 16 F - ACTUATORS AND SIGNAL INDICATORS



RAFIX 16 F Emergency stop pushbutton, round collar

Technical data see page 2 - 56

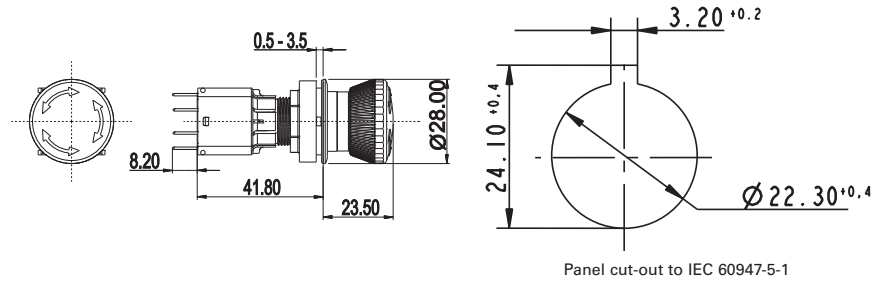

→ Contact function	Illumination	Color of mushroom	Mounting hole	Order no.
latching	no	red, collar yellow	Ø 22.3 mm	1.30.094.011/0300

Only use universal contact blocks.

Accessoires:

Emergency stop label, Ø 22.3 mm: see page 2 - 82, 2 - 149, 2 - 264, 5 - 21

2

RAFIX
16

RAFIX 16 F Signal indicators

Technical Data

→ General information

Form of lens	see order block
Color of lens	see order block
Form of collar	see order block
Color of collar	see order block

→ Dimensions

Collar dimensions	see order block
Overall height	see order block
Mounting depth with contact block	50 mm
Key grid	see order block
Mounting hole	see order block

→ Mechanical design

Mounting	ring nut
Contact function	-
Illumination	yes

→ Other specifications

Operating life (operations)	-
Degree of protection from front side	IP65 (DIN EN 60529)
Operation temperature min.	-25 °C
Ambient temp. operating max. without lamp /LED	-
Ambient temp. operating max. with lamp /LED	+55 °C
Storage temperature min.	-40 °C
Storage temperature max.	+85 °C
Environmental resistance	acc. to IEC 60068-2-14, -30, -33 and -78
ROHS compliant	yes
REACH compliant	yes



Approvals



IEC 61058, 25T55



in preparation



2

RAFIX
16

Accessories RAFIX 16 F - Signal indicator

→ Description	Photo	Order no.	Additional accessories see page
RAFIX 16 - Lamp socket		-	2 - 73
Socket W 2 x 4.6d, LED superbright		-	5 - 5
Fixing spanner for hexagon nut		5.58.002.034/0000	2 - 78, 5 - 26
Legend insert, blank, use only for transparent lenses		5.70.635.000/2000	-

For additional accessories, refer to the chapter „RAFIX 16 special accessories“

CONTROL COMPONENTS

RAFIX 16 F - ACTUATORS AND SIGNAL INDICATORS



RAFIX 16 F Signal indicator, flush lens, square black collar

Technical data see page 2 - 59

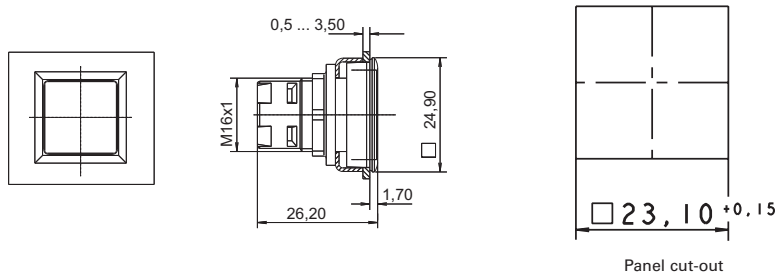

→ Color of collar	Overall height	Color of lens	Order no. complete	Order no. single parts	
				Housing	Lens
black	1.7 mm	transparent red	1.65.126.301/1300	1.65.126.401/0000	5.49.077.011/1306
black	1.7 mm	transparent yellow	1.65.126.301/1400	1.65.126.401/0000	5.49.077.011/1403
black	1.7 mm	transparent green	1.65.126.301/1500	1.65.126.401/0000	5.49.077.011/1505
black	1.7 mm	transparent blue	1.65.126.301/1600	1.65.126.401/0000	5.49.077.011/1607
black	1.7 mm	transparent colorless	1.65.126.301/1000	1.65.126.401/0000	5.49.077.011/1002

Accessoires:

Legend insert, blank, use only for transparent lenses: 5.70.635.000/2000



RAFIX 16 F Signal indicator, flush lens, round black collar

Technical data see page 2 - 59

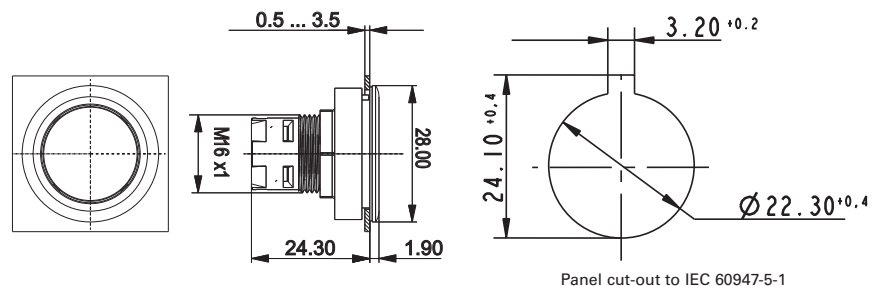

→ Color of collar	Overall height	Color of lens	Order no. complete	Order no. single parts	
				Housing	Lens
black	1.9 mm	transparent red	1.65.126.001/1300	1.65.126.101/0000	5.49.259.017/1306
black	1.9 mm	transparent yellow	1.65.126.001/1400	1.65.126.101/0000	5.49.259.017/1403
black	1.9 mm	transparent green	1.65.126.001/1500	1.65.126.101/0000	5.49.259.017/1505

– Table (continued) –

RAFIX 16 F - Signal indicator, flush lens, round black collar

→ Color of collar	Overall height	Color of lens	Order no. complete	Order no. single parts	
				Housing	Lens
black	1.9 mm	transparent blue	1.65.126.001/1600	1.65.126.101/0000	5.49.259.017/1607
black	1.9 mm	transparent colorless	1.65.126.001/1000	1.65.126.101/0000	5.49.259.017/1002

RAFIX 16 F Signal indicator, flush lens, round metallized collar

Technical data see page 2 - 59

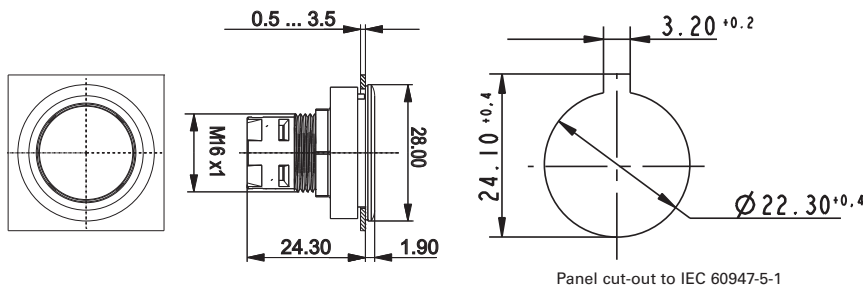

→ Color of collar	Overall height	Color of lens	Order no. complete	Order no. single parts	
				Housing	Lens
silver metallic	1.9 mm	transparent red	1.65.126.011/1300	-	-
silver metallic	1.9 mm	transparent yellow	1.65.126.011/1400	-	-
silver metallic	1.9 mm	transparent green	1.65.126.011/1500	-	-
silver metallic	1.9 mm	transparent blue	1.65.126.011/1600	-	-
silver metallic	1.9 mm	transparent colorless	1.65.126.011/1000	-	-

CONTROL COMPONENTS

RAFIX 16 - CONTACT BLOCKS AND INDICATOR ELEMENTS

2

RAFIX
16

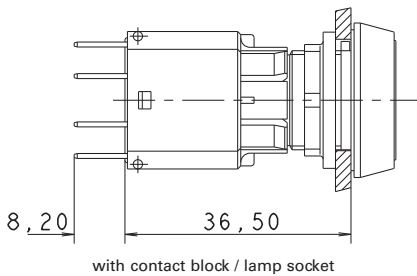
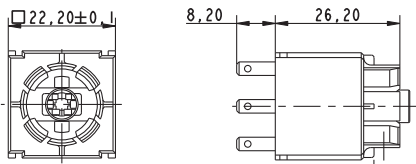

RAFIX 16 Contact blocks with gold contacts

Technical Data

→ Dimensions

Size not mounted	see order block
Mounting depth (with actuator / indicator)	see order block

→ Mechanical design

Mounting	snap on actuator
Contact system	bridge-contact self cleaning
Contact materials	Au
Contact arrangement	see order block
Contact function	see order block
Lamp socket	see order block
Terminals	see order block
Terminal marking	according to DIN 50013, X1 = +, X2 = -
Operating travel	3 mm
Robustness	100 N

→ Mechanical characteristics

Robustness	acc. to IEC 60947-5-5
------------	-----------------------

→ Electrical characteristics

Rated voltage min.	0.02 V
Rated voltage AC/DC max.	35 V
Rated current min.	0.001 A
Rated current max.	0.25 A
Operating life switching element (momentary)	2,000,000
Contact resistance when new max.	50 mΩ

→ Other specifications

Protection class	II
Shock resistance acc. to IEC 60068-2-27	amplitude < 50g, 11ms, half sinusoidal
Operation temperature min.	-25 °C
Ambient temp. operating max. without lamp /LED	+70 °C
Ambient temp. operating max. with lamp /LED	+55 °C
Storage temperature min.	-40 °C
Storage temperature max.	+85 °C
Color code	white bottom
Environmental resistance	acc. to IEC 60068-2-14, -30, -33 and -78
Mechanical operating life latching (operations)	2,000,000
Resistance to vibrations acc. to IEC 60068-2-6	10 g at 20 ... 500 Hz
Flame class acc. to UL 94	yes
	yes
ROHS compliant	yes
REACH compliant	yes

Accessories RAFIX 16 - Contact blocks with gold contacts

→ Description	Photo	Order no.	Additional accessories see page
Socket W 2 x 4.6d, LED superbright		-	5 - 5

RAFIX 16 Standard contact block, gold contacts, with quick-connect terminals

Technical data see page 2 - 62

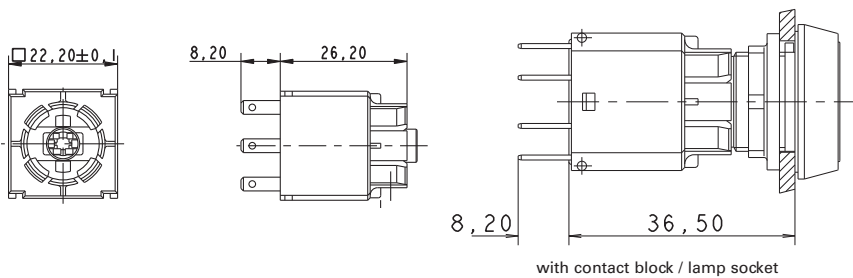

→ Contact arrangement	Contact function	Lamp socket	Rated voltage AC/DC max.	Rated current max.	Order no.
2 NO	momentary	W 2 x 4.6d	35 V	0.25 A	1.20.122.012/0000
2 NO	momentary	-	35 V	0.25 A	1.20.122.032/0000
2 NO	latching	W 2 x 4.6d	35 V	0.25 A	1.20.122.052/0000
2 NC	momentary	W 2 x 4.6d	35 V	0.25 A	1.20.122.013/0000
2 NC	momentary	-	35 V	0.25 A	1.20.122.033/0000
1 NC + 1 NO	momentary	W 2 x 4.6d	35 V	0.25 A	1.20.122.011/0000
1 NC + 1 NO	momentary	-	35 V	0.25 A	1.20.122.031/0000
1 NC + 1 NO	latching	W 2 x 4.6d	35 V	0.25 A	1.20.122.051/0000

Standard contact blocks have one common contact chamber and one actuator plunger.

Contact blocks with „latching“ contact function are used as switches. When combined with pushbuttons and mushroom actuators, the switching position is visible, releasing is effected by actuating again.

Accessoires:

- Female quick-connect terminal DIN 46340-B 2.8-1-MS: see page 2 - 76, 2 - 262, 5 - 27
- Multipole connector: see page 2 - 76
- PCB plug-in socket: see page 2 - 75
- Plug distributor: see page 2 - 76, 5 - 27
- Protection against contact: see page 2 - 77

CONTROL COMPONENTS

RAFIX 16 - CONTACT BLOCKS AND INDICATOR ELEMENTS



RAFIX 16 Standard contact block, gold contacts, with screw terminals

Technical data see page 2 - 62

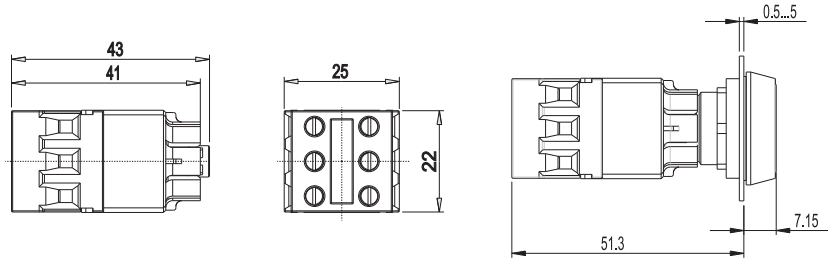

2

RAFIX
16

→ Contact arrangement	Contact function	Lamp socket	Rated voltage AC/DC max.	Rated current max.	Order no.
2 NO	momentary	W 2 x 4.6d	35 V	0.25 A	1.20.122.112/0000
2 NO	momentary	-	35 V	0.25 A	1.20.122.132/0000
2 NO	latching	W 2 x 4.6d	35 V	0.25 A	1.20.122.152/0000
2 NO	latching	-	35 V	0.25 A	1.20.122.172/0000
2 NC	momentary	W 2 x 4.6d	35 V	0.25 A	1.20.122.113/0000
2 NC	momentary	-	35 V	0.25 A	1.20.122.133/0000
2 NC	latching	W 2 x 4.6d	35 V	0.25 A	1.20.122.153/0000
2 NC	latching	-	35 V	0.25 A	1.20.122.173/0000
1 NC + 1 NO	momentary	W 2 x 4.6d	35 V	0.25 A	1.20.122.111/0000
1 NC + 1 NO	momentary	-	35 V	0.25 A	1.20.122.131/0000
1 NC + 1 NO	latching	W 2 x 4.6d	35 V	0.25 A	1.20.122.151/0000
1 NC + 1 NO	latching	-	35 V	0.25 A	1.20.122.171/0000

RAFIX 16 Universal contact block, gold contacts, with quick-connect terminals

Technical data see page 2 - 62

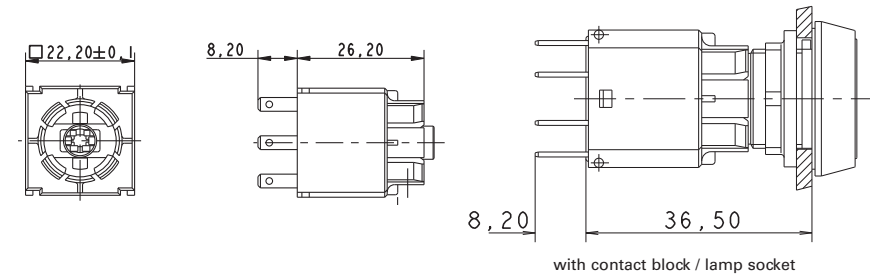

→ Contact arrangement	Contact function	Lamp socket	Rated voltage AC/DC max.	Rated current max.	Order no.
1 NO	momentary	W 2 x 4.6d	35 V	0.25 A	1.20.123.013/0000
1 NO	momentary	-	35 V	0.25 A	1.20.123.033/0000
1 NC	momentary	-	35 V	0.25 A	1.20.123.032/0000
2 NO	momentary	W 2 x 4.6d	35 V	0.25 A	1.20.123.015/0000
2 NO	momentary	-	35 V	0.25 A	1.20.123.035/0000
2 NC	momentary	W 2 x 4.6d	35 V	0.25 A	1.20.123.014/0000
2 NC	momentary	-	35 V	0.25 A	1.20.123.034/0000
1 NC + 1 NO	momentary	W 2 x 4.6d	35 V	0.25 A	1.20.123.011/0000
1 NC + 1 NO	momentary	-	35 V	0.25 A	1.20.123.031/0000

Universal contact blocks have two separate contact chambers and two actuator plungers for alternating actuation directions. Two different polarities can be switched. The NC contacts are positive opening contacts to IEC 60947-5-1.

Accessoires:

Female quick-connect terminal DIN 46340-B 2.8-1-MS: see page 2 - 76, 2 - 262, 5 - 27

Multipole connector: see page 2 - 76

PCB plug-in socket: see page 2 - 75

Plug distributor: see page 2 - 76, 5 - 27

Protection against contact: see page 2 - 77

CONTROL COMPONENTS

RAFIX 16 - CONTACT BLOCKS AND INDICATOR ELEMENTS



RAFIX 16 Universal contact block, gold contacts, with screw terminals

Technical data see page 2 - 62

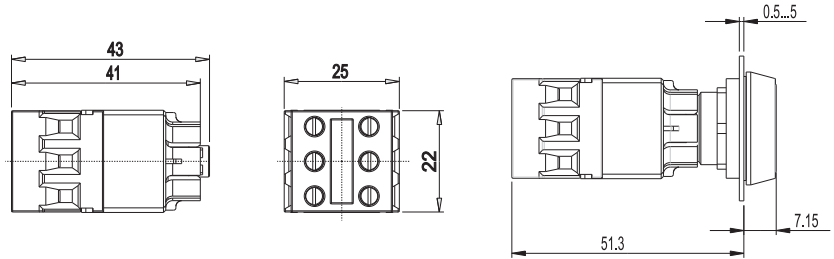

2

RAFIX
16

→ Contact arrangement	Contact function	Lamp socket	Rated voltage AC/DC max.	Rated current max.	Order no.
1 NO	momentary	W 2 x 4.6d	35 V	0.25 A	1.20.123.113/0000
1 NO	momentary	-	35 V	0.25 A	1.20.123.133/0000
1 NC	momentary	W 2 x 4.6d	35 V	0.25 A	1.20.123.112/0000
1 NC	momentary	-	35 V	0.25 A	1.20.123.132/0000
2 NO	momentary	W 2 x 4.6d	35 V	0.25 A	1.20.123.115/0000
2 NO	momentary	-	35 V	0.25 A	1.20.123.135/0000
2 NC	momentary	W 2 x 4.6d	35 V	0.25 A	1.20.123.114/0000
2 NC	momentary	-	35 V	0.25 A	1.20.123.134/0000
1 NC + 1 NO	momentary	W 2 x 4.6d	35 V	0.25 A	1.20.123.111/0000
1 NC + 1 NO	momentary	-	35 V	0.25 A	1.20.123.131/0000

Universal contact blocks have two separate contact chambers and two actuator plungers for alternating actuation directions. Two different polarities can be switched. The NC contacts are positive opening contacts to IEC 60947-5-1.

RAFIX 16

Contact blocks with silver contacts

Technical Data

→ Dimensions	
Size not mounted	see order block
Mounting depth (with actuator / indicator)	see order block
→ Mechanical design	
Mounting	snap on actuator
Contact system	bridge-contact self cleaning
Contact materials	Ag
Contact arrangement	see order block
Contact function	see order block
Lamp socket	see order block
Terminals	see order block
Terminal marking	according to DIN 50013, X1 = +, X2 = -
Operating travel	3 mm
Robustness	100 N
→ Mechanical characteristics	
Robustness	acc. to IEC 60947-5-5
→ Electrical characteristics	
Rated insulation voltage acc. to VDE 0110, AC	250 V
Rated insulation voltage acc. to VDE 0110, DC	300 V
Ohmic rated current I_R	6 A
Rated motor current $I_{M\text{,nenn}}$	4 A
Application category acc. to VDE 0660 Teil 200	AC 15B 300
Application category acc. to VDE 0660 Teil 200	DC 13Q 300
Rated insulation voltage U_i , AC	250 V
Rated insulation voltage U_i , DC	300 V
Rated voltage U_E / rated current I_E , AC	250 V/1.5 A, 120 V/3.0 A V
Rated voltage U_E / rated current I_E , DC	250 V/0.27 A, 125 V/0.55 A, 60 V/1 A, 24 V/2 A V
Thermic rated current I_{the} , AC	5 A
Thermic rated current I_{the} , DC	2.5 A
Operating life switching element AC	100,000 at 6A, 800,000 at 2A
Operating life switching element DC	250,000 at 220 V/0.2 A, 1,000,000 at 24 V/2 A
Rated power DC	$10 \times I_E$
Rated power AC	$1.1 \times I_E$
Contact resistance when new max.	20 m Ω
→ Other specifications	
Protection class	II
Corresponding to EU directive NSR 72/73	yes
Shock resistance acc. to IEC 60068-2-27	amplitude < 50g, 11ms, half sinusoidal
Operation temperature min.	-25 °C
Ambient temp. operating max. without lamp /LED	+70 °C
Ambient temp. operating max. with lamp /LED	+55 °C
Storage temperature min.	-40 °C
Storage temperature max.	+85 °C
Color code	grey bottom
Environmental resistance	acc. to IEC 60068-2-14, -30, -33 and -78
Mechanical operating life latching (operations)	100,000

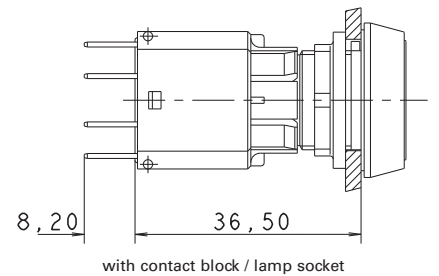
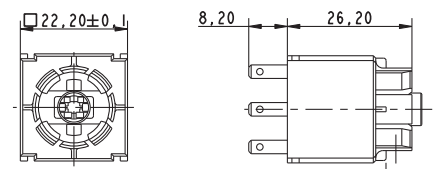

Approvals



IEC 61058, 25T70
without lamp,
25T55 with lamp

C22.2 No.
14-M91

CONTROL COMPONENTS

RAFIX 16 - CONTACT BLOCKS AND INDICATOR ELEMENTS

- Technical data (continued) -

RAFIX 16 - Contact blocks with silver contacts

Resistance to vibrations acc. to IEC 60068-2-6	10 g at 20 ... 500 Hz
Flame class acc. to UL 94	V 0
Hot wire ignition acc. to IEC 60695-2-1	yes
ROHS compliant	yes
REACH compliant	yes

Accessories RAFIX 16 - Contact blocks with silver contacts

→ Description	Photo	Order no.	Additional accessories see page
Socket W 2 x 4.6d, LED superbright		-	5 - 5

2

RAFIX
16



RAFIX 16 Standard contact block, silver contacts, with quick-connect terminals

Technical data see page 2 - 67

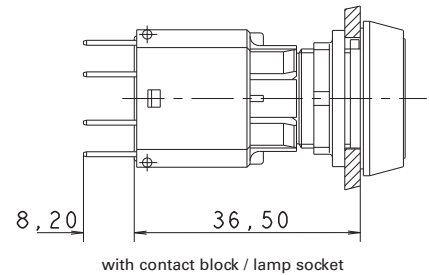
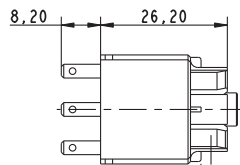
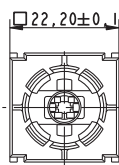

→ Contact arrangement	Contact function	Lamp socket	Rated insulation voltage U_i , AC	Ohmic rated current I_n	Order no.
2 NO	momentary	W 2 x 4.6d	250 V	6 A	1.20.122.002/0000
2 NO	momentary	-	250 V	6 A	1.20.122.022/0000
2 NO	latching	W 2 x 4.6d	250 V	6 A	1.20.122.042/0000
2 NO	latching	-	250 V	6 A	1.20.122.062/0000
2 NC	momentary	W 2 x 4.6d	250 V	6 A	1.20.122.003/0000
2 NC	momentary	-	250 V	6 A	1.20.122.023/0000
1 NC + 1 NO	momentary	W 2 x 4.6d	250 V	6 A	1.20.122.001/0000
1 NC + 1 NO	momentary	-	250 V	6 A	1.20.122.021/0000
1 NC + 1 NO	latching	W 2 x 4.6d	250 V	6 A	1.20.122.041/0000
1 NC + 1 NO	latching	-	250 V	6 A	1.20.122.061/0000

– Table (continued) –

RAFIX 16 - Standard contact block, silver contacts, with quick-connect terminals

Standard contact blocks have one common contact chamber and one actuator plunger.

Contact blocks with „latching“ contact function are used as switches. When combined with pushbuttons and mushroom actuators, the switching position is visible, releasing is effected by actuating again.

Accessoires:

Female quick-connect terminal DIN 46340-B 2.8-1-MS: see page 2 - 76, 2 - 262, 5 - 27

Multipole connector: see page 2 - 76

PCB plug-in socket: see page 2 - 75

Plug distributor: see page 2 - 76, 5 - 27

Protection against contact: see page 2 - 77

RAFIX 16 Standard contact block, silver contacts, with screw terminals

Technical data see page 2 - 67

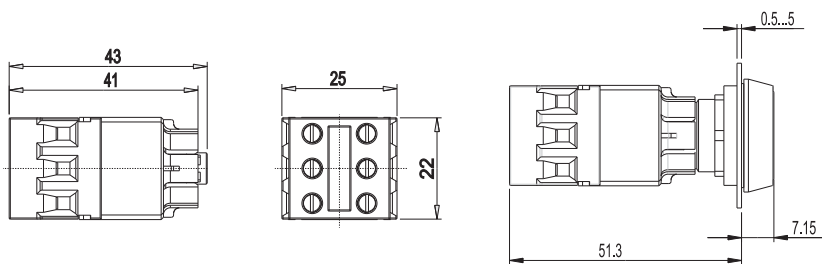

→ Contact arrangement	Contact function	Lamp socket	Rated insulation voltage U_i , AC	Ohmic rated current I_n	Order no.
2 NO	momentary	W 2 x 4.6d	250 V	6 A	1.20.122.102/0000
2 NO	momentary	-	250 V	6 A	1.20.122.122/0000
2 NO	latching	W 2 x 4.6d	250 V	6 A	1.20.122.142/0000
2 NO	latching	-	250 V	6 A	1.20.122.162/0000
2 NC	momentary	W 2 x 4.6d	250 V	6 A	1.20.122.103/0000
2 NC	momentary	-	250 V	6 A	1.20.122.123/0000
2 NC	latching	W 2 x 4.6d	250 V	6 A	1.20.122.143/0000
2 NC	latching	-	250 V	6 A	1.20.122.163/0000
1 NC + 1 NO	momentary	W 2 x 4.6d	250 V	6 A	1.20.122.101/0000
1 NC + 1 NO	momentary	-	250 V	6 A	1.20.122.121/0000
1 NC + 1 NO	latching	W 2 x 4.6d	250 V	6 A	1.20.122.141/0000
1 NC + 1 NO	latching	-	250 V	6 A	1.20.122.161/0000

Standard contact blocks have one common contact chamber and one actuator plunger.

Contact blocks with „latching“ contact function are used as switches. When combined with pushbuttons and mushroom actuators, the switching position is visible, releasing is effected by actuating again.

CONTROL COMPONENTS

RAFIX 16 - CONTACT BLOCKS AND INDICATOR ELEMENTS



RAFIX 16 Universal contact block, silver contacts, with quick-connect terminals

Technical data see page 2 - 67

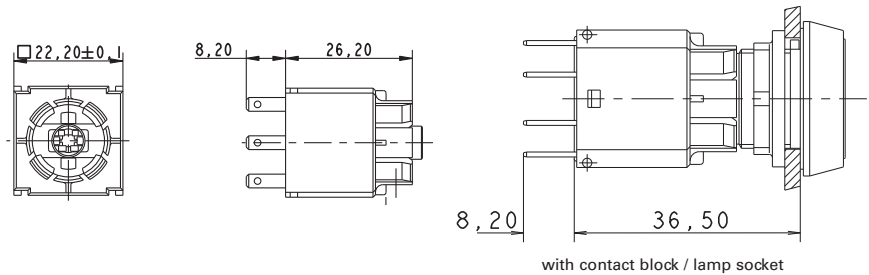

→ Contact arrangement	Contact function	Lamp socket	Rated insulation voltage U_i , AC	Ohmic rated current I_R	Order no.
1 NO	momentary	W 2 x 4.6d	250 V	6 A	1.20.123.003/0000
1 NO	momentary	-	250 V	6 A	1.20.123.023/0000
1 NC	momentary	-	250 V	6 A	1.20.123.022/0000
2 NO	momentary	W 2 x 4.6d	250 V	6 A	1.20.123.005/0000
2 NO	momentary	-	250 V	6 A	1.20.123.025/0000
2 NC	momentary	W 2 x 4.6d	250 V	6 A	1.20.123.004/0000
2 NC	momentary	-	250 V	6 A	1.20.123.024/0000
1 NC + 1 NO	momentary	W 2 x 4.6d	250 V	6 A	1.20.123.001/0000
1 NC + 1 NO	momentary	-	250 V	6 A	1.20.123.021/0000

Universal contact blocks have two separate contact chambers and two actuator plungers. This makes it possible to switch two different polarities. The NC contacts are positive opening contacts to IEC 60947-5-1.

Accessoires:

Female quick-connect terminal DIN 46340-B 2.8-1-MS: see page 2 - 76, 2 - 262, 5 - 27

Multipole connector: see page 2 - 76

PCB plug-in socket: see page 2 - 75

Plug distributor: see page 2 - 76, 5 - 27

Protection against contact: see page 2 - 77

RAFIX 16 Universal contact block with coupling monitoring, silver contacts, with quick-connect terminals



Technical data see page 2 - 67

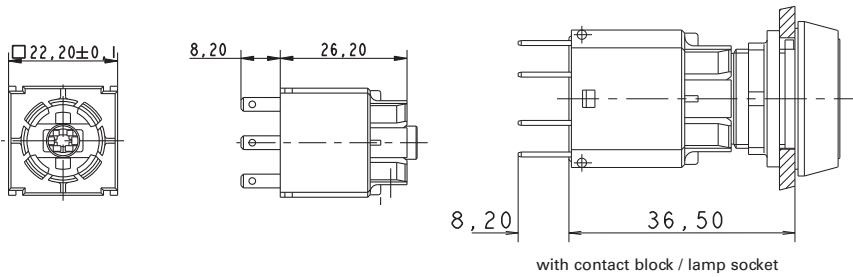

→ Contact arrangement	Contact function	Lamp socket	Rated insulation voltage U_i , AC	Ohmic rated current I_n	Order no.
2 NC + 1 NO	momentary	-	250 V	6 A	1.20.123.921/0000

Function

The contact block with coupling monitoring detects a accidental separation of the contact block from of the front-side actuator by a contact.

Universal contact blocks have two separate contact chambers and two actuator plungers. This makes it possible to switch two different polarities. The NC contacts are positive opening contacts to IEC 60947-5-1.

Accessoires:

Female quick-connect terminal DIN 46340-B 2.8-1-MS: see page 2 - 76, 2 - 262, 5 - 27

Multipole connector: see page 2 - 76

PCB plug-in socket: see page 2 - 75

Plug distributor: see page 2 - 76, 5 - 27

Protection against contact: see page 2 - 77

RAFIX 16 Universal contact block, silver contacts, with screw terminals

Technical data see page 2 - 67

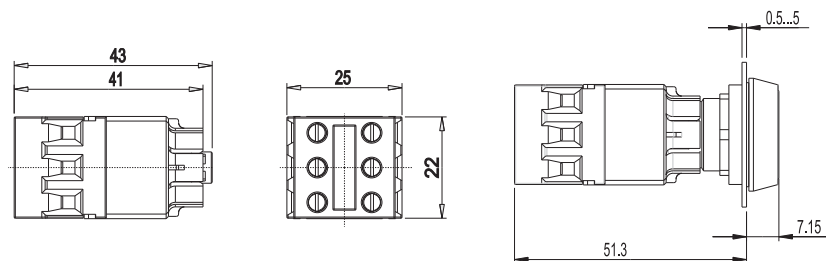

→ Contact arrangement	Contact function	Lamp socket	Rated insulation voltage U_i , AC	Ohmic rated current I_n	Order no.
1 NO	momentary	W 2 x 4.6d	250 V	6 A	1.20.123.103/0000

CONTROL COMPONENTS

RAFIX 16 - CONTACT BLOCKS AND INDICATOR ELEMENTS

– Table (continued) –

RAFIX 16 - Universal contact block, silver contacts, with screw terminals

→ Contact arrangement	Contact function	Lamp socket	Rated insulation voltage U_i , AC	Ohmic rated current I_R	Order no.
1 NO	momentary	-	250 V	6 A	1.20.123.123/0000
1 NC	momentary	W 2 x 4.6d	250 V	6 A	1.20.123.102/0000
1 NC	momentary	-	250 V	6 A	1.20.123.122/0000
2 NO	momentary	W 2 x 4.6d	250 V	6 A	1.20.123.104/0000
2 NO	momentary	-	250 V	6 A	1.20.123.124/0000
2 NC	momentary	W 2 x 4.6d	250 V	6 A	1.20.123.105/0000
2 NC	momentary	-	250 V	6 A	1.20.123.125/0000
1 NC + 1 NO	momentary	W 2 x 4.6d	250 V	6 A	1.20.123.101/0000
1 NC + 1 NO	momentary	-	250 V	6 A	1.20.123.121/0000

Universal contact blocks have two separate contact chambers and two actuator plungers. This makes it possible to switch two different polarities. The NC contacts are positive opening contacts to IEC 60947-5-1.

2

RAFIX
16

RAFIX 16 Lamp sockets

Technical Data

→ Dimensions	
Size not mounted	see order block
Mounting depth	see order block
→ Mechanical design	
Mounting	see order block
Lamp socket	wedge-base W 2 x 4.6d
Terminals	quick connector 2.8 x 0.8 mm
Terminal marking	X1 = anode, X2 = cathode
→ Electrical characteristics	
Rated voltage	60 V
Rated power	1.2 W
→ Other specifications	
Shock resistance acc. to IEC 60068-2-27	amplitude < 50g, 11ms, half sinusoidal
Ambient temp. operating min.	-25 °C
Ambient temp. operating max. with lamp /LED	+55 °C
Storage temperature min.	-40 °C
Storage temperature max.	+85 °C
Environmental resistance	acc. to IEC 60068-2-14, -30, -33 and -78
Flame class acc. to UL 94	V 0
Hot wire ignition acc. to IEC 60695-2-1	yes
Resistance to vibrations acc. to IEC 60068-2-6	10 g at 20 ... 500 Hz
ROHS compliant	yes
REACH compliant	yes



Approvals



IEC 61058, 25T55



C22.2 No. 14-M91



Accessories RAFIX 16 - Lamp socket

→ Description	Photo	Order no.	Additional accessories see page
Female quick-connect terminal DIN 46340-B 2.8-1-MS		-	2 - 76, 2 - 262, 5 - 27
Multipole connector		-	2 - 76
PCB plug-in socket		-	2 - 75
Plug distributor		-	2 - 76, 5 - 27
Protection against contact		-	2 - 77
RAFIX 16 - Signal indicator		-	2 - 39
RAFIX 16 F - Signal indicator		-	2 - 59
Socket W 2 x 4.6d, LED superbright		-	5 - 5

CONTROL COMPONENTS

RAFIX 16 - CONTACT BLOCKS AND INDICATOR ELEMENTS

– Table (continued) –
Accessories RAFIX 16 - Lamp socket

→ Description	Photo	Order no.	Additional accessories see page
Wedge base W 2 x 4.6d, filament lamps, DIN 49846		-	5 - 9

2

RAFIX 16



RAFIX 16 Lamp socket W 2 x 4.6 d

Technical data see page 2 - 73

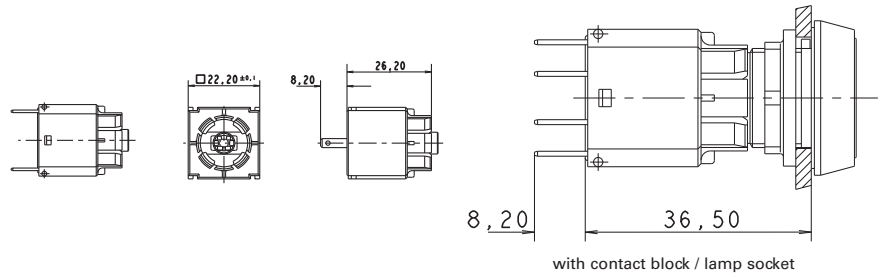

→ Rated voltage	Rated power	Lamp socket	Mounting	Mounting depth	Order no.
60 V	1.2 W	wedge-base W 2 x 4.6d	click on signal indicator	44.7 mm	1.71.212.001/0000

A notch on the lamp socket identifies the cathode side.



RAFIX 16 Lamp socket W 2 x 4.6 d

Technical data see page 2 - 73

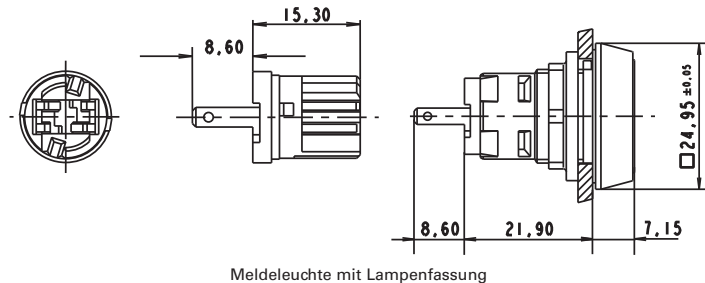

→ Rated voltage	Rated power	Lamp socket	Mounting	Mounting depth	Order no.
60 V	1.2 W	wedge-base W 2 x 4.6d	snap into signal indicator	30.5 mm	1.71.212.011/0000

A notch on the lamp socket identifies the cathode side.

RAFIX 16 Special accessories



2

RAFIX
16

PCB plug-in socket

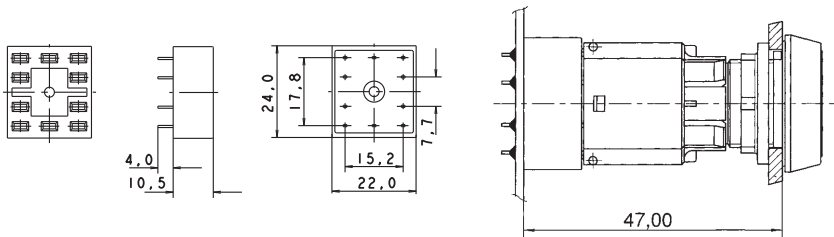

→ Contacts	Contact arrangement	Order no.
10	universal application	5.05.510.644/0000
6	2 NO, lamp socket	5.05.510.645/0000
6	2 NC, lamp socket	5.05.510.647/0000
6	1 NC, 1 NO, lamp socket	5.05.510.646/0000
4	2 NC	5.05.510.648/0000
2	lamp socket	5.05.510.649/0000

For soldering onto PCBs. The PCB carrying the plug-in sockets is plugged onto the contact blocks/lamp sockets. Additional fixing of the PCB to the contact block is not required. Solder terminals for PCB 3.5 mm long, for 1.3 mm hole.

CONTROL COMPONENTS

RAFIX 16 - SPECIAL ACCESSORIES



Multipole connector

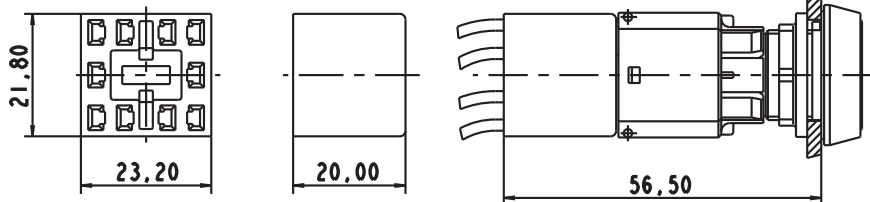

→ Dimensions	Mounting depth	Order no.
21,8 x 23,2 x 20 mm	56.5 mm	5.05.510.421/0000

Makes it possible to simultaneously connect all terminals of a contact block. Can be fitted with 2.8 mm female quick-connect terminals.



Female quick-connect terminal DIN 46340-B 2.8-1-MS

→ Description	Order no.
Female quick-connect terminal DIN 46340-B 2.8-1-MS	5.37.540.024/8622

With latching detent for mating with a multipole connector.



Plug distributor

→ Description	Order no.
Plug distributor	5.37.540.029/6000

For mounting on the quick-connect terminals of contact blocks. The double number of contacts facilitates loop-through.

2

RAFIX
16

Protection against contact

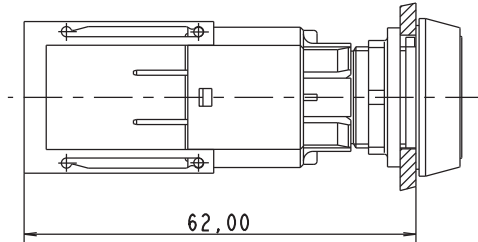

→ **Description**

Order no.

Protection against contact

5.55.103.105/0100

Assembly sequence: Snap the protection against contact onto the contact block, connect wires to quick-connect terminals of contact block, pull protection against contact over the terminals; this ensures finger-proof condition to VBG 4.

Protective cover, suitable for lead seal, for pushbuttons, alignable without gaps



→ **Description**

Order no.

Protective cover, suitable for lead seal

5.05.800.055/0000

To prevent inadvertent operation. The legend is easily visible even when the cap is closed.

CONTROL COMPONENTS

RAFIX 16 - SPECIAL ACCESSORIES

Fixing spanner for hexagon nut



2

→ Fitting for	Order no.
RAFIX 16	5.58.002.034/0000

RAFIX
16



RAFIX Insulating housing, Ø 16.2 mm

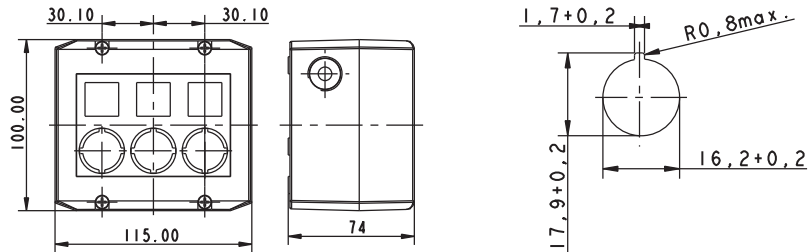

Panel cut-out

→ Description	Number of cut-outs	Ø	Dimensions	Order no.
RAFIX - Insulating housing, Ø 16.2 mm, IP65, 1-module, light grey/dark grey	1	16,2 mm	100x55x74 mm	1.20.810.001/0000
RAFIX - Insulating housing, Ø 16.2 mm, IP65, 1-module, yellow/yellow	1	16,2 mm	100x55x74 mm	1.20.810.002/0000
RAFIX - Insulating housing, Ø 16.2 mm, IP65, 2-module, light grey/dark grey	2	16,2 mm	100x115x74 mm	1.20.820.001/0000
RAFIX - Insulating housing, Ø 16.2 mm, IP65, 3-module, light grey/dark grey	3	16,2 mm	100x115x74 mm	1.20.830.001/0000
RAFIX - Insulating housing, Ø 16.2 mm, IP65, 4-module, light grey/dark grey	4	16,2 mm	100x145x74 mm	1.20.840.001/0000

– Table (continued) –

RAFIX - Insulating housing, Ø 16.2 mm

- Attractive plastic housing to accommodate up to 4 control components
- 2 cable entries prepared: 1-,2-,3-part: M20x1.5, 4-part: M25x1.5
- Degree of protection IP65 to DIN EN 60529
- All grey housings with overlay, legending possible with legend inserts
- Wall mounting with 2 screws through housing bottom prepared
- Dimensions (feature 1) x 100 mm x 74 mm
- Accessories: 50 pre-perforated legend inserts on a DIN A4 sheet for printing with a PC printer
- Housings with other features, e.g. RAFIX 16 square, on request.

Accessoires:

Label sheet for housing (50 foil legend inserts): 5.40.451.283/0000

RAFIX Insulating housing IP65, Ø 22.3 mm

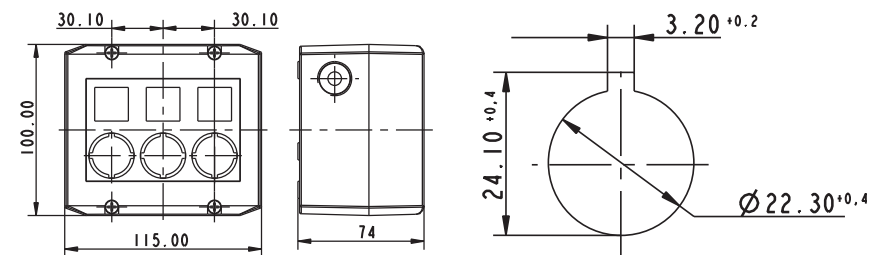

Panel cut-out to IEC 60947-5-1



→ Description	Number of cut-outs	Ø	Dimensions	Order no.
RAFIX - Insulating housing, Ø 22.3 mm, IP65, 1-module, light grey/dark grey	1	22,3 mm	100x55x74 mm	1.20.810.201/0000
RAFIX - Insulating housing, Ø 22.3 mm, IP65, 1-module, yellow/yellow	1	22,3 mm	100x55x74 mm	1.20.810.202/0000
RAFIX - Insulating housing, Ø 22.3 mm, IP65, 2-module, light grey/dark grey	2	22,3 mm	100x115x74 mm	1.20.820.201/0000
RAFIX - Insulating housing, Ø 22.3 mm, IP65, 3-module, light grey/dark grey	3	22,3 mm	100x115x74 mm	1.20.830.201/0000
RAFIX - Insulating housing, Ø 22.3 mm, IP65, 4-module, light grey/dark grey	4	22,3 mm	100x145x74 mm	1.20.840.201/0000

- Plastic housing to accommodate up to 4 control components
- 2 cable entries prepared: 1-,2-,3-part: M20x1.5, 4-part: M25x1.5
- Degree of protection IP65 to DIN EN 60529
- All grey housings with overlay, legending possible with legend inserts
- Wall mounting with 2 screws through housing bottom prepared
- Dimensions: (feature 2) x 100 mm x 74 mm
- Accessories: 50 pre-perforated legend inserts on a DIN A4 sheet

Accessoires:

Label sheet for housing (50 foil legend inserts): 5.40.451.283/0000

CONTROL COMPONENTS

RAFIX 16 - SPECIAL ACCESSORIES



RAFIX 16 Label holder, flush, for square collar

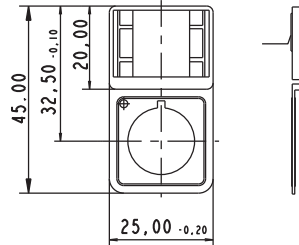

→ Description	Order no.
Label holder, flush, for square collar	5.07.620.004/0000

Legending available on request.

Accessoires:

Legend label 23 x 16 for label holder, without legend: 5.73.111.000/0000



RAFIX 16 Label holder, flush, for round collar

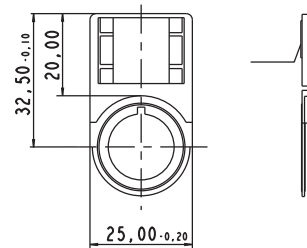

→ Description	Order no.
Label holder, flush, for round collar	5.07.620.006/0000

Legending available on request.

Accessoires:

Legend label 23 x 16 for label holder, without legend: 5.73.111.000/0000

2

RAFIX
16

RAFIX 16 Label holder, protruding, for square flush fitting collar

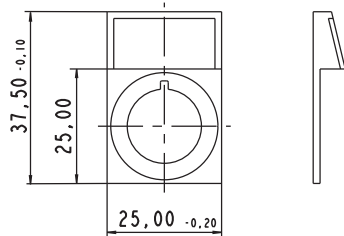

→ Description	Order no.
Label holder, protruding, for square flush fitting collar	5.07.620.007/0000

Legending available on request.

Accessoires:

Legend label 22.1 x 11.0 mm, without legend: 5.73.112.000/0000

Emergency stop label, PVC adhesive, Ø 16.3 mm



→ Dimensions	inside Ø	Label	Order no.
Ø 40 mm	16.3 mm	„NOT-HALT, EMERGENCY STOP, ARRET D'URGENCE, EMERGENZA“	5.76.204.114/0400
Ø 40 mm	16.3 mm	4 x „NOT-HALT“	5.76.204.116/0400
Ø 40 mm	16.3 mm	4 x „NOT-AUS“	5.76.204.118/0400
Ø 40 mm	16.3 mm	4 x „EMERGENCY STOP“	5.76.204.120/0400
Ø 60 mm	16.3 mm	-	5.76.204.400/0400
Ø 60 mm	16.3 mm	1 x „NOT-AUS“	5.76.204.401/0400
Ø 60 mm	16.3 mm	1 x „EMERGENCY STOP“	5.76.204.403/0400
Ø 60 mm	16.3 mm	„NOT-HALT, EMERGENCY STOP, ARRET D'URGENCE, EMERGENZA“	5.76.204.106/0400
Ø 60 mm	16.3 mm	4 x „NOT-HALT“	5.76.204.108/0400

CONTROL COMPONENTS

RAFIX 16 - SPECIAL ACCESSORIES

– Table (continued) –
Emergency stop label, PVC adhesive, Ø 16.3 mm

→ Dimensions	inside Ø	Label	Order no.
Ø 60 mm	16.3 mm	4 x „NOT-AUS“	5.76.204.110/0400
Ø 60 mm	16.3 mm	4 x „EMERGENCY STOP“	5.76.204.112/0400

Emergency stop label, Ø 22.3 mm

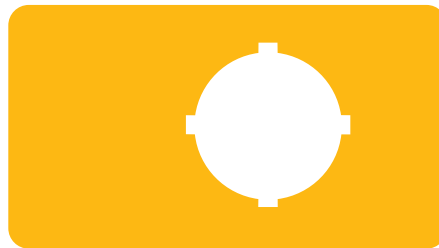

→ Dimensions	inside Ø	Label	Order no.
36 x 64 mm	22.3 mm	-	5.76.205.011/0400
Ø 40 mm	22.3 mm	„NOT-HALT, EMERGENCY STOP, ARRET D'URGENCE, EMERGENZA“	5.76.204.115/0400
Ø 40 mm	22.3 mm	4 x „NOT-HALT“	5.76.204.117/0400
Ø 40 mm	22.3 mm	4 x „NOT-AUS“	5.76.204.119/0400
Ø 40 mm	22.3 mm	4 x „EMERGENCY STOP“	5.76.204.121/0400
Ø 60 mm	22.3 mm	1 x „NOT-AUS“	5.76.207.001/0400
Ø 60 mm	22.3 mm	„EMERGENCY-STOP / ARRET D'URGENCE“	5.76.207.002/0400
Ø 60 mm	22.3 mm	1 x „NOT-AUS“	5.76.204.101/0400
Ø 60 mm	22.3 mm	1 x „ARRET D'URGENCE“	5.76.204.102/0400
Ø 60 mm	22.3 mm	1 x „EMERGENCY STOP“	5.76.204.103/0400
Ø 60 mm	22.3 mm	„NOT-HALT, EMERGENCY STOP, ARRET D'URGENCE, EMERGENZA“	5.76.204.107/0400
Ø 60 mm	22.3 mm	4 x „NOT-HALT“	5.76.204.109/0400
Ø 60 mm	22.3 mm	4 x „NOT-AUS“	5.76.204.111/0400
Ø 60 mm	22.3 mm	4 x „EMERGENCY STOP“	5.76.204.113/0400

2

RAFIX
16

RAFIX 16 Blanking cap with sealing and threaded ring, Ø 16.2 mm



→ Description	Order no.
Blanking cap complete with sealing disc and ring nut, square	5.05.800.049/0100
Blanking cap complete with sealing disc and ring nut, round	5.05.800.050/0100
Blanking cap complete with sealing disc and ring nut, square, alignable without gaps	5.05.800.051/0100

2

RAFIX
16

RAFIX 16 F Blanking cap

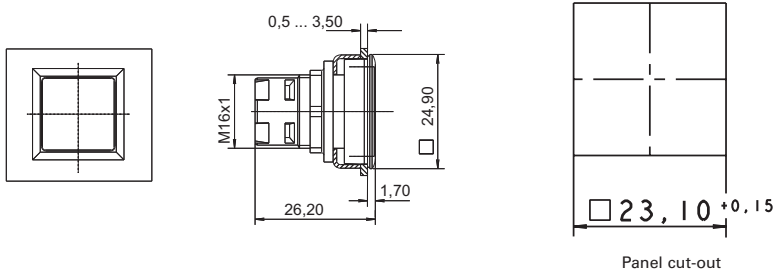

→ Installation dimensions	Dimenions	Color	Order no.
23,1 x 23,1 mm	24,9 x 24,9	black	5.05.800.063/0000

CONTROL COMPONENTS

RAFIX 22 QR

Content

RAFIX 22 QR Pushbuttons	2 - 91
RAFIX 22 QR Pushbutton, flush lens, round collar	2 - 92
RAFIX 22 QR Pushbutton, protruding lens, round collar	2 - 93
RAFIX 22 QR Pushbutton, protruding front ring, round collar	2 - 94
RAFIX 22 QR Pushbutton, flush lens, square collar	2 - 95
RAFIX 22 QR Pushbutton, protruding lens, square collar	2 - 96
RAFIX 22 QR Pushbutton, protruding front ring, square collar	2 - 97
RAFIX 22 QR Pushbuttons with protective cap	2 - 98
RAFIX 22 QR Pushbutton with protective cap, flush lens, round collar	2 - 99
RAFIX 22 QR Pushbutton with protective cap, flush lens, square collar	2 - 100
RAFIX 22 QR Selector switches	2 - 101
RAFIX 22 QR Selector switch, round collar, short handle	2 - 102
RAFIX 22 QR Selector switch, round collar, long handle	2 - 103
RAFIX 22 QR Selector switch, square collar, short handle	2 - 105
RAFIX 22 QR Selector switch, square collar, long handle	2 - 106
RAFIX 22 QR Keylock switches	2 - 108
RAFIX 22 QR Keylock switch, round collar	2 - 109
RAFIX 22 QR Keylock switch, square collar	2 - 111
RAFIX 22 QR Mushroom-headed pushbuttons	2 - 114
RAFIX 22 QR Mushroom-headed pushbutton 40 mm, round collar	2 - 115
RAFIX 22 QR Mushroom-headed pushbutton 40 mm, illuminated, round collar	2 - 116
RAFIX 22 QR Mushroom-headed pushbutton 40 mm, square collar	2 - 116
RAFIX 22 QR Mushroom-headed pushbutton 40 mm, illuminated, square collar	2 - 117
RAFIX 22 QR Emergency stop pushbuttons, dupe-proof to EN ISO 13850	2 - 118
RAFIX 22 QR Emergency stop pushbutton	2 - 119
RAFIX 22 QR Emergency stop pushbutton, with indication	2 - 120
RAFIX 22 QR Emergency stop pushbutton, with keylock	2 - 120
RAFIX 22 QR Emergency stop pushbutton, illuminable	2 - 121
RAFIX 22 QR Emergency stop pushbutton, reset by pulling	2 - 122
RAFIX 22 QR Toggle switches	2 - 123
RAFIX 22 QR Toggle switch, round collar	2 - 124
RAFIX 22 QR Toggle switch, square collar	2 - 124
RAFIX 22 QR Twin pushbuttons	2 - 125
RAFIX 22 QR Twin pushbutton, oval collar	2 - 126
RAFIX 22 QR Twin pushbutton, rectangular collar	2 - 126
RAFIX 22 QR Potentiometer drives	2 - 127
RAFIX 22 QR Potentiometer drive, round collar	2 - 128
RAFIX 22 QR Potentiometer drive, square collar	2 - 128
RAFIX 22 QR Buzzers	2 - 129
RAFIX 22 QR Buzzer, round collar	2 - 130
RAFIX 22 QR Buzzer, square collar	2 - 130
RAFIX 22 QR Signal indicators	2 - 131
RAFIX 22 QR Signal indicator, flat, round collar, for legend inserts	2 - 132
RAFIX 22 QR Signal indicator, high, round collar	2 - 133
RAFIX 22 QR Signal indicator, flat, square collar, for legend inserts	2 - 133
RAFIX 22 QR Signal indicator, high, square collar	2 - 134
RAFIX 22 QR Contact blocks with silver contacts	2 - 135
RAFIX 22 QR Contact block with silver contacts	2 - 136
RAFIX 22 QR Contact block assembly, with coupling, silver contacts	2 - 137

2

RAFIX
22 QR

Content

RAFIX 22 QR Contact blocks with gold contacts	2 - 138
RAFIX 22 QR Contact block with gold contacts	2 - 139
RAFIX 22 QR Contact block assembly, with coupling, gold contacts	2 - 140
RAFIX 22 QR Lamp sockets BA 9s (MBC/MCC)	2 - 141
RAFIX 22 QR Lamp socket BA 9s, without coupling	2 - 142
RAFIX 22 QR Lamp socket BA 9s, assembly with coupling	2 - 142
RAFIX 22 QR LED units	2 - 143
RAFIX 22 QR LED unit, without coupling	2 - 144
RAFIX 22 QR Special accessories	2 - 145
Fixing spanner for ring nut and front ring	2 - 145
Label holder	2 - 145
Legend label to clip into label holder 5.07.620.xxx	2 - 146
Coupling	2 - 146
RAFIX 22 QR Blanking cap, Ø 22.3 mm	2 - 147
Protective cover, suitable for pushbuttons with flush lens	2 - 147
RAFIX Insulating housing IP65, Ø 22.3 mm	2 - 148
Emergency stop label, Ø 22.3 mm	2 - 149
RAFIX 22 QR Protective Collar	2 - 150

CONTROL COMPONENTS

RAFIX 22 QR

Control Components RAFIX 22 QR



Contact blocks marked with different colors for ease of identification in stock and when connecting.

- NC contacts: red cover
- NO contacts: green cover
- NC/NO contacts: one cover red, one cover green
- Lamp socket: black
- Silver contacts: basic housing color is black
- Gold contacts: basic housing color is grey
- The terminals associated with a contact pair are color coded on the connection side and marked with the respective contact numbers:
1, 2 = NC
3, 4 = NO

The lamps of pushbuttons and signal lamps can be replaced from the front. This method saves time and increases safety since it eliminates the need for accessing the machine/control station interior and handling live cables for lamp replacement. After unscrewing the front ring, the lens can be removed and the lamp replaced.



The components feature a removable locating lug. If installed without locating lug, the ring nut with claw can be used. Accurate alignment of the actuator can be achieved behind the front panel. The cast-on collar seal can not get lost nor be twisted during installation and allows single-person assembly: the actuator is held in the mounting hole by the cast-on seal and can then be fixed by screwing from the rear.

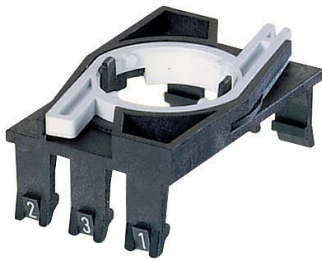

First, snap the lamp socket and contact blocks into the coupling. Then snap the assembly on to the actuator. To release it, the bayonet must be pressed (prevents inadvertent releasing at the same time)

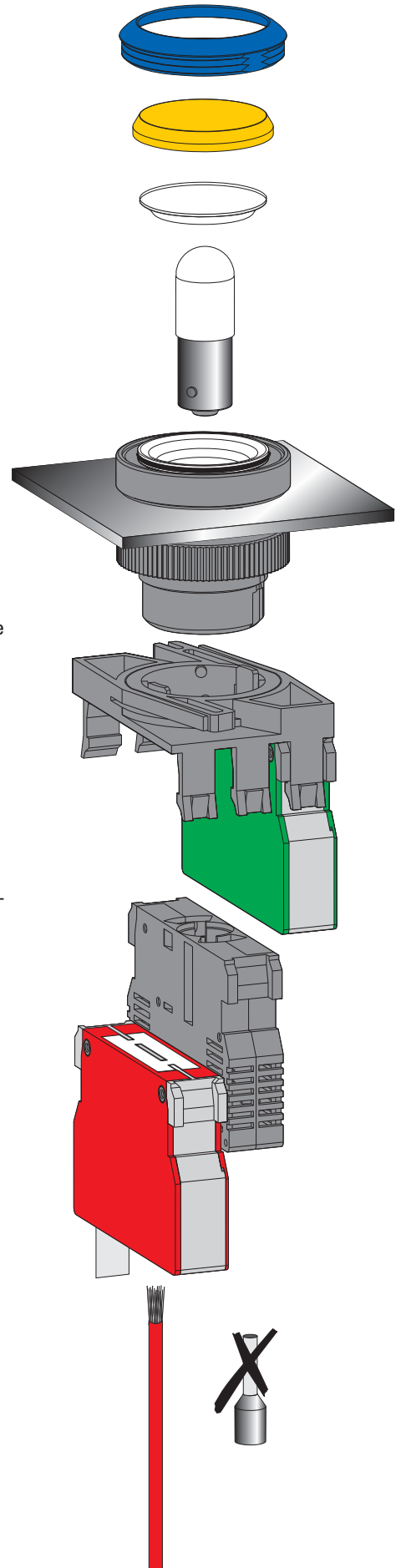

2

RAFIX
22 QR

Terminals

The RAFIX 22 QR contact blocks are available in different connection styles as required for your application:

- **Screw terminals**
The terminals are open and the captive screws are mounted in the terminal recess.
- **Quick connect/solder terminals 6.3 x 0.8 mm**
- **Spring-type terminals**
Simply insert a screwdriver to open the terminal, insert the cable and remove the screwdriver to close the terminal.

Your advantage:

This offers your savings in three ways:

- Drastically reduced assembly time thanks to wire insertion from the rear, i. e. no more bending and lateral insertion of the wires required.
- You save material: No wire end sleeves are required.
- You save the time previously required for mounting the wire end sleeves.

Assembly

Screw terminals



Insert the wire

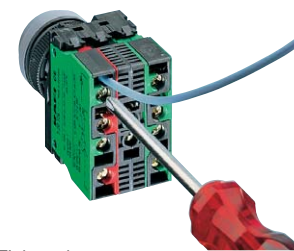

Tighten the screw



Done

Spring-type terminals



Open the terminal

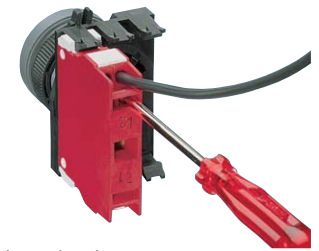

Insert the wire



Remove the screwdriver

2

RAFIX
22 QR

Versatility of design for customized panels



The RAFIX 22 QR system does not only have a particularly low profile and is also available in many different versions. Your design options for your customized panels are nearly unlimited thanks to the interchangeable front rings and lenses. In this way you can achieve an attractive design while ensuring safe operation of your equipment at the same time. RAFIX 22 QR components are available either with a round or with a square collar.

CONTROL COMPONENTS

RAFIX 22 QR

The RAFIX 22 QR control component range meets all the technical requirements and current standards for control units. The system is of modular design. Actuators, contact blocks and lamp sockets can be combined freely.



2

Sequence of assembly/disassembly

- Fix the actuator in the front panel with the ring nut.
- Snap the individual elements (maximum two contact blocks together with a lamp socket) in the coupling. You can install them on any assembling axis.
- Insert the lamp or LED into the lamp socket or snap the LED unit.
- Snap the coupling with the contact blocks on to the actuator.
- Connect the cables.
- Disassembly is performed in reverse order. To remove the coupling from the actuator, the latch lever must be pressed (by hand or with a screwdriver).

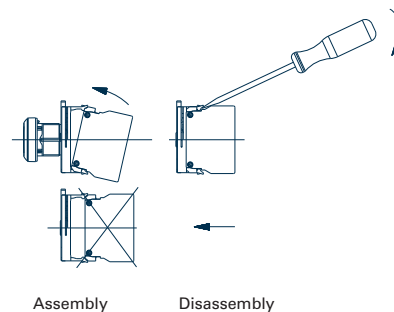

RAFIX
22 QR

Panel cut-out according to IEC 60947-5-1

All actuators are provided with a locating lug which may be removed using a screwdriver for installation into mounting holes if required.

With a grid spacing of 30 mm horizontally and 50 mm vertically, the collars of the square actuators touch each other. We recommend to use the same grid spacing also for the round collar shapes (IEC 60947-5-1)

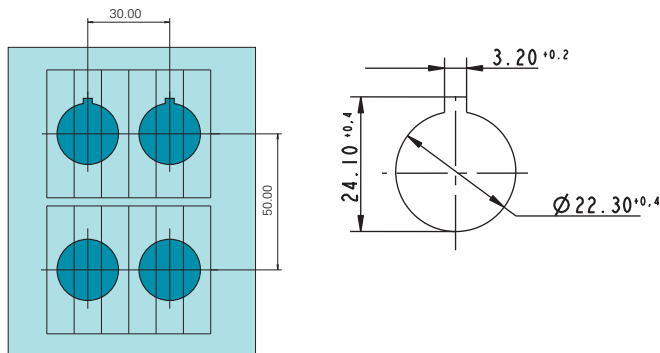

Dimensional drawing

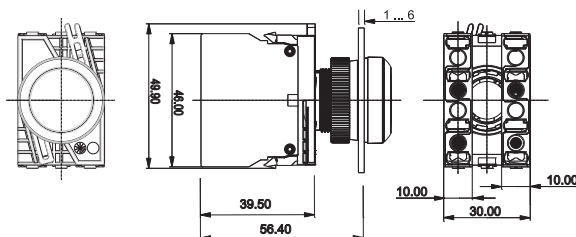

RAFIX 22 QR Pushbuttons

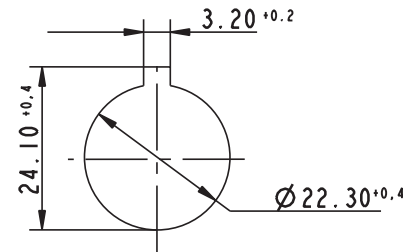
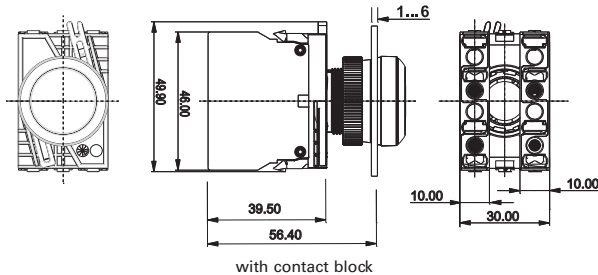

Panel cut-out to IEC 60947-5-1

Technical Data

→ General information

Form of lens	see order block
Color of lens	see order block
Color of front ring	see order block
Form of collar	see order block

→ Dimensions

Dimensions of collar	see order block
Overall height	see order block
Mounting depth with contact block	56.4 mm
without cable	
Mounting hole	Ø 22.3 mm
Mounting grid	50 x 30 mm

→ Mechanical design

Mounting	ring nut
Contact function	see order block
Illumination	see order block

→ Mechanical characteristics

Operating travel	4 mm
Operating force max.	approx. 5 N for 1 switching element
Robustness max.	100 N

→ Other specifications

Operating life (operations)	1,000,000 momentary / 500,000 latching
Degree of protection from front side	IP65 (DIN EN 60529)
Ambient temp. operating min.	-25 °C
Ambient temp. operating max.	+70 °C
Storage temperature min.	-40 °C
Storage temperature max.	+80 °C
Environmental resistance	acc. to IEC 60068-2-14, -30, -33 and -78
ROHS compliant	yes
REACH compliant	yes

Approvals



UL 508, C22.2 No.
14-M91



2004 Steel Vessel
Rules



Rules for the
Classification of
Steel Ships



Marine, offshore
and industrial
use



German Lloyds
type approval



Accessories RAFIX 22 QR - Pushbutton



→ Description

Description	Photo	Order no.	Additional accessories see page
RAFIX - Insulating housing IP65, Ø 22.3 mm		-	2 - 79, 2 - 148, 5 - 20
RAFIX 22 QR - Contact blocks with gold contacts		-	2 - 138
RAFIX 22 QR - Contact blocks with silver contacts		-	2 - 135

CONTROL COMPONENTS

RAFIX 22 QR - ACTUATORS AND INDICATORS

**– Table (continued) –
Accessories RAFIX 22 QR - Pushbutton**

→ Description	Photo	Order no.	Additional accessories see page
Socket BA 9s (MBC/MCC), LED superbright		-	5 - 8
Fixing spanner for ring nut		5.05.800.062/0000	2 - 145, 2 - 261, 5 - 25



RAFIX 22 QR Pushbutton, flush lens, round collar

Technical data see page 2 - 91

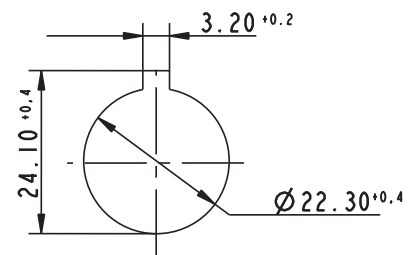
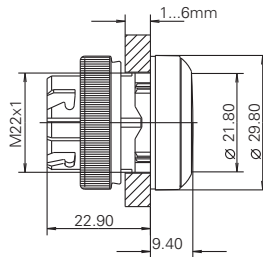

Panel cut-out to IEC 60947-5-1

→ Illumination	Color of lens	Order no. momentary		Order no. latching	
		Plastic front ring	Metallized front ring	Plastic front ring	Metallized front ring
yes	transparent red	1.30.240.001/13xx	1.30.240.021/1300	1.30.240.011/13xx	1.30.240.031/1300
yes	transparent yellow	1.30.240.001/14xx	1.30.240.021/1400	1.30.240.011/14xx	1.30.240.031/1400
yes	transparent green	1.30.240.001/15xx	1.30.240.021/1500	1.30.240.011/15xx	1.30.240.031/1500
yes	transparent blue	1.30.240.001/16xx	1.30.240.021/1600	1.30.240.011/16xx	1.30.240.031/1600
yes	transparent white	1.30.240.001/10xx	1.30.240.021/1000	1.30.240.011/10xx	1.30.240.031/1000
no	opaque red	1.30.240.101/03xx	1.30.240.121/0300	1.30.240.111/03xx	1.30.240.131/0300
no	opaque yellow	1.30.240.101/04xx	1.30.240.121/0400	1.30.240.111/04xx	1.30.240.131/0400
no	opaque green	1.30.240.101/05xx	1.30.240.121/0500	1.30.240.111/05xx	1.30.240.131/0500
no	opaque blue	1.30.240.101/06xx	1.30.240.121/0600	1.30.240.111/06xx	1.30.240.131/0600
no	opaque white	1.30.240.101/02xx	1.30.240.121/0200	1.30.240.111/02xx	1.30.240.131/0200
no	opaque slate-grey	1.30.240.101/07xx	1.30.240.121/0700	1.30.240.111/07xx	1.30.240.131/0700
no	opaque black	1.30.240.101/01xx	1.30.240.121/0100	1.30.240.111/01xx	1.30.240.131/0100

xx = Front ring color: black = 01, slate grey = 07, silver grey = 08

Pushbuttons with plastic front ring and white lens are also available with the following front ring colors: red = 03, yellow = 04, green = 05, blue = 06. Other color combinations on request.

Accessoires:

Label holder, round collar, with adhesive tape and release liner on back 50 x 30 x 3.6 mm: 5.07.620.010/0000

Protective cover, suitable for pushbuttons with flush lens: see page 2 - 147

2

RAFIX
22 QR

RAFIX 22 QR Pushbutton, protruding lens, round collar

Technical data see page 2 - 91

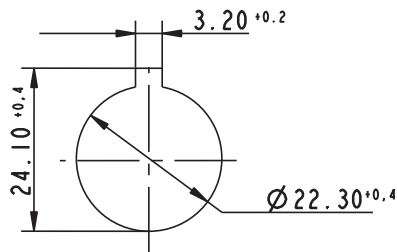
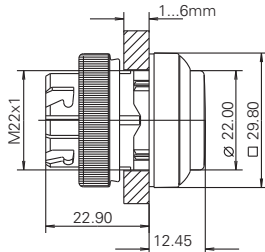

Panel cut-out to IEC 60947-5-1



2

→ Illumination	Color of lens	Order no. momentary		Order no. latching	
		Plastic front ring	Metallized front ring	Plastic front ring	Metallized front ring
yes	transparent red	1.30.240.201/13xx	1.30.240.221/1300	1.30.240.211/13xx	1.30.240.231/1300
yes	transparent yellow	1.30.240.201/14xx	1.30.240.221/1400	1.30.240.211/14xx	1.30.240.231/1400
yes	transparent green	1.30.240.201/15xx	1.30.240.221/1500	1.30.240.211/15xx	1.30.240.231/1500
yes	transparent blue	1.30.240.201/16xx	1.30.240.221/1600	1.30.240.211/16xx	1.30.240.231/1600
yes	transparent white	1.30.240.201/10xx	1.30.240.221/1000	1.30.240.211/10xx	1.30.240.231/1000
no	opaque red	1.30.240.301/03xx	1.30.240.321/0300	1.30.240.311/03xx	1.30.240.331/0300
no	opaque yellow	1.30.240.301/04xx	1.30.240.321/0400	1.30.240.311/04xx	1.30.240.331/0400
no	opaque green	1.30.240.301/05xx	1.30.240.321/0500	1.30.240.311/05xx	1.30.240.331/0500
no	opaque blue	1.30.240.301/06xx	1.30.240.321/0600	1.30.240.311/06xx	1.30.240.331/0600
no	opaque white	1.30.240.301/02xx	1.30.240.321/0200	1.30.240.311/02xx	1.30.240.331/0200
no	opaque slate-grey	1.30.240.301/07xx	1.30.240.321/0700	1.30.240.311/07xx	1.30.240.331/0700
no	opaque black	1.30.240.301/01xx	1.30.240.321/0100	1.30.240.311/01xx	1.30.240.331/0100

RAFIX
22 QR

xx = Front ring color: black = 01, slate grey = 07, silver grey = 08

Pushbuttons with plastic front ring and white lens are also available with the following front ring colors: red = 03, yellow = 04, green = 05, blue = 06. Other color combinations on request.

Accessoires:

Label holder, round collar, with adhesive tape and release liner on back 50 x 30 x 3.6 mm: 5.07620.010/0000

CONTROL COMPONENTS

RAFIX 22 QR - ACTUATORS AND INDICATORS



RAFIX 22 QR Pushbutton, protruding front ring, round collar

Technical data see page 2 - 91

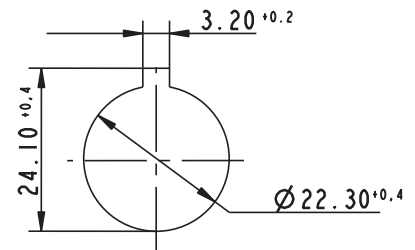
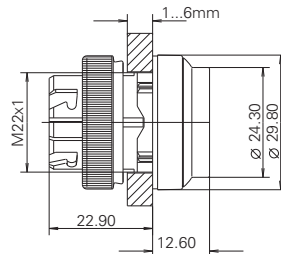

Panel cut-out to IEC 60947-5-1

Illumination	Color of lens	Order no. momentary	
		Plastic front ring	Metallized front ring
yes	transparent red	1.30.240.401/13xx	1.30.240.421/1300
yes	transparent yellow	1.30.240.401/14xx	1.30.240.421/1400
yes	transparent green	1.30.240.401/15xx	1.30.240.421/1500
yes	transparent blue	1.30.240.401/16xx	1.30.240.421/1600
yes	transparent white	1.30.240.401/10xx	1.30.240.421/1000
no	opaque red	1.30.240.501/03xx	1.30.240.521/0300
no	opaque yellow	1.30.240.501/04xx	1.30.240.521/0400
no	opaque green	1.30.240.501/05xx	1.30.240.521/0500
no	opaque blue	1.30.240.501/06xx	1.30.240.521/0600
no	opaque white	1.30.240.501/02xx	1.30.240.521/0200
no	opaque slate-grey	1.30.240.501/07xx	1.30.240.521/0700
no	opaque black	1.30.240.501/01xx	1.30.240.521/0100

xx = Front ring color: black = 01, slate grey = 07, silver grey = 08

The protruding collar offers protection against inadvertent operation and thereby fulfils the safety requirements of various machinery manufacturers, particularly from the printing industry.

Accessoires:

Label holder, round collar, with adhesive tape and release liner on back 50 x 30 x 3.6 mm: 5.07620.010/0000

2

RAFIX
22 QR

RAFIX 22 QR Pushbutton, flush lens, square collar

Technical data see page 2 - 91

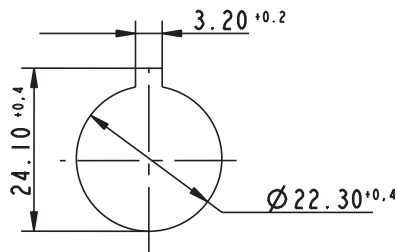
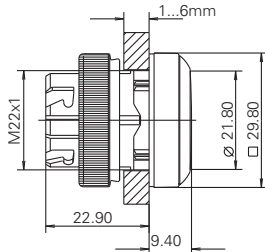

Panel cut-out to IEC 60947-5-1



2

→ Illumination	Color of lens	Order no. momentary		Order no. latching	
		Plastic front ring	Metallized front ring	Plastic front ring	Metallized front ring
yes	transparent red	1.30.240.051/13xx	1.30.240.071/1300	1.30.240.061/13xx	1.30.240.081/1300
yes	transparent yellow	1.30.240.051/14xx	1.30.240.071/1400	1.30.240.061/14xx	1.30.240.081/1400
yes	transparent green	1.30.240.051/15xx	1.30.240.071/1500	1.30.240.061/15xx	1.30.240.081/1500
yes	transparent blue	1.30.240.051/16xx	1.30.240.071/1600	1.30.240.061/16xx	1.30.240.081/1600
yes	transparent white	1.30.240.051/10xx	1.30.240.071/1000	1.30.240.061/10xx	1.30.240.081/1000
no	opaque red	1.30.240.151/03xx	1.30.240.171/0300	1.30.240.161/03xx	1.30.240.181/0300
no	opaque yellow	1.30.240.151/04xx	1.30.240.171/0400	1.30.240.161/04xx	1.30.240.181/0400
no	opaque green	1.30.240.151/05xx	1.30.240.171/0500	1.30.240.161/05xx	1.30.240.181/0500
no	opaque blue	1.30.240.151/06xx	1.30.240.171/0600	1.30.240.161/06xx	1.30.240.181/0600
no	opaque white	1.30.240.151/02xx	1.30.240.171/0200	1.30.240.161/02xx	1.30.240.181/0200
no	opaque slate-grey	1.30.240.151/07xx	1.30.240.171/0700	1.30.240.161/07xx	1.30.240.181/0700
no	opaque black	1.30.240.151/01xx	1.30.240.171/0100	1.30.240.161/01xx	1.30.240.181/0100

RAFIX 22 QR

xx = Front ring color: black = 01, slate grey = 07, silver grey = 08

Pushbuttons with plastic front ring and white lens are also available with the following front ring colors: red = 03, yellow = 04, green = 05, blue = 06. Other color combinations on request.

Accessoires:

Label holder, square collar, with adhesive tape and release liner on back 50 x 30 x 3.6 mm: 5.07.620.011/0000

CONTROL COMPONENTS

RAFIX 22 QR - ACTUATORS AND INDICATORS



RAFIX 22 QR Pushbutton, protruding lens, square collar

Technical data see page 2 - 91

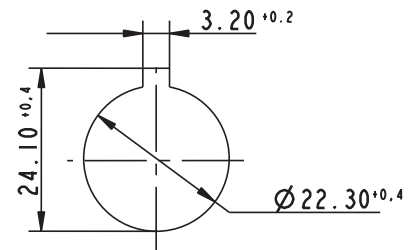
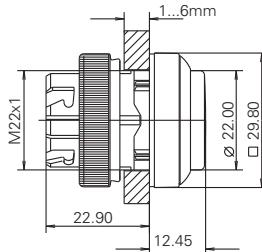

Panel cut-out to IEC 60947-5-1

→ Illumination	Color of lens	Order no. momentary		Order no. latching	
		Plastic front ring	Metallized front ring	Plastic front ring	Metallized front ring
yes	transparent red	1.30.240.251/13xx	1.30.240.271/1300	1.30.240.261/13xx	1.30.240.281/1300
yes	transparent yellow	1.30.240.251/14xx	1.30.240.271/1400	1.30.240.261/14xx	1.30.240.281/1400
yes	transparent green	1.30.240.251/15xx	1.30.240.271/1500	1.30.240.261/15xx	1.30.240.281/1500
yes	transparent blue	1.30.240.251/16xx	1.30.240.271/1600	1.30.240.261/16xx	1.30.240.281/1600
yes	transparent white	1.30.240.251/10xx	1.30.240.271/1000	1.30.240.261/10xx	1.30.240.281/1000
no	opaque red	1.30.240.351/03xx	1.30.240.371/0300	1.30.240.361/03xx	1.30.240.381/0300
no	opaque yellow	1.30.240.351/04xx	1.30.240.371/0400	1.30.240.361/04xx	1.30.240.381/0400
no	opaque green	1.30.240.351/05xx	1.30.240.371/0500	1.30.240.361/05xx	1.30.240.381/0500
no	opaque blue	1.30.240.351/06xx	1.30.240.371/0600	1.30.240.361/06xx	1.30.240.381/0600
no	opaque white	1.30.240.351/02xx	1.30.240.371/0200	1.30.240.361/02xx	1.30.240.381/0200
no	opaque slate-grey	1.30.240.351/07xx	1.30.240.371/0700	1.30.240.361/07xx	1.30.240.381/0700
no	opaque black	1.30.240.351/01xx	1.30.240.371/0100	1.30.240.361/01xx	1.30.240.381/0100

xx = Front ring color: black = 01, slate grey = 07, silver grey = 08

Pushbuttons with plastic front ring and white lens are also available with the following front ring colors: red = 03, yellow = 04, green = 05, blue = 06. Other color combinations on request.

Accessoires:

Label holder, square collar, with adhesive tape and release liner on back 50 x 30 x 3.6 mm: 5.07620.011/0000

2

RAFIX
22 QR

RAFIX 22 QR Pushbutton, protruding front ring, square collar

Technical data see page 2 - 91

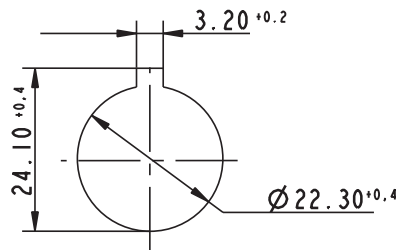
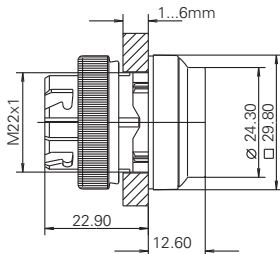

Panel cut-out to IEC 60947-5-1



2

RAFIX
22 QR

Illumination	Color of lens	Order no. momentary	
		Plastic front ring	Metallized front ring
yes	transparent red	1.30.240.451/13xx	1.30.240.471/1300
yes	transparent yellow	1.30.240.451/14xx	1.30.240.471/1400
yes	transparent green	1.30.240.451/15xx	1.30.240.471/1500
yes	transparent blue	1.30.240.451/16xx	1.30.240.471/1600
yes	transparent white	1.30.240.451/10xx	1.30.240.471/1000
no	opaque red	1.30.240.551/03xx	1.30.240.571/0300
no	opaque yellow	1.30.240.551/04xx	1.30.240.571/0400
no	opaque green	1.30.240.551/05xx	1.30.240.571/0500
no	opaque blue	1.30.240.551/06xx	1.30.240.571/0600
no	opaque white	1.30.240.551/02xx	1.30.240.571/0200
no	opaque slate-grey	1.30.240.551/07xx	1.30.240.571/0700
no	opaque black	1.30.240.551/01xx	1.30.240.571/0100

xx = Front ring color: black = 01, slate grey = 07, silver grey = 08

The protruding collar offers protection against inadvertent operation and thereby fulfils the safety requirements of various machinery manufacturers, particularly in the industry.

Accessoires:

Label holder, square collar, with adhesive tape and release liner on back 50 x 30 x 3.6 mm: 5.07.620.011/0000

CONTROL COMPONENTS

RAFIX 22 QR - ACTUATORS AND INDICATORS

2



RAFIX 22 QR Pushbuttons with protective cap

→ Pushbutton with protective cap for use under rugged conditions.

Technical Data

→ General information

Form of lens	flat lens
Color of lens	see order block
Color of front ring	see order block
Form of collar	see order block

→ Dimensions

Dimensions of collar	see order block
Overall height	see order block
Mounting depth with contact block without cable	56.4 mm
Mounting hole	Ø 22.3 mm
Mounting grid	50 x 30 mm

→ Mechanical design

Mounting	ring nut
Contact function	momentary
Illumination	see order block

→ Mechanical characteristics

Operating travel	4 mm
Operating force max.	approx. 5 N for 1 switching element
Robustness max.	100 N

→ Other specifications

Operating life (operations)	1,000,000 momentary
Degree of protection from front side	IP65 (DIN EN 60529); IP69K (ISO 20653), water temp. 23 °C ±3 °C
Ambient temp. operating min.	-25 °C
Ambient temp. operating max.	+70 °C
Storage temperature min.	-40 °C
Storage temperature max.	+80 °C
Environmental resistance	acc. to IEC 60068-2-14, -30, -33 and -78
ROHS compliant	yes
REACH compliant	yes

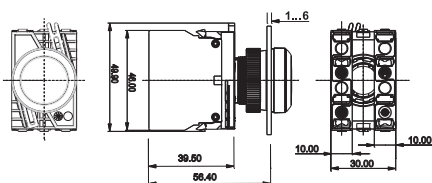

with contact block

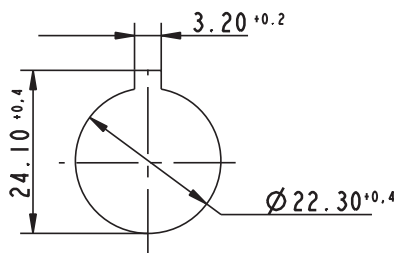

Panel cut-out to IEC 60947-5-1

Approvals



UL 508, C22.2 No. 14-M91



2004 Steel Vessel Rules



Rules for the Classification of Steel Ships







Marine, offshore and industrial use



German Lloyd's type approval



Accessories RAFIX 22 QR - Pushbutton with protective cap

→ Description	Photo	Order no.	Additional accessories see page
RAFIX - Insulating housing IP65, Ø 22.3 mm		-	2 - 79, 2 - 148, 5 - 20
RAFIX 22 QR - Contact blocks with gold contacts		-	2 - 138
RAFIX 22 QR - Contact blocks with silver contacts		-	2 - 135
Socket BA 9s (MBC/MCC), LED superbright		-	5 - 8
Fixing spanner for ring nut		5.05.800.062/0000	2 - 145, 2 - 261, 5 - 25

RAFIX 22 QR Pushbutton with protective cap, flush lens, round collar

Technical data see page 2 - 98

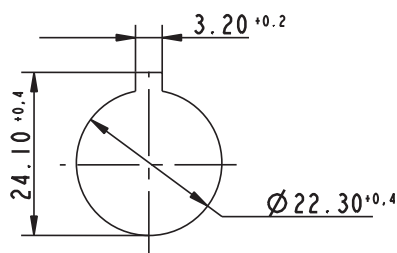
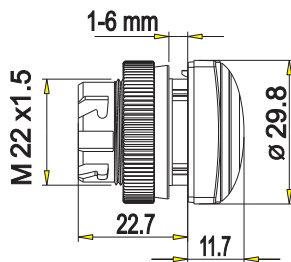

Panel cut-out to IEC 60947-5-1



→ Illumination	Color of lens	Order no. momentary		Order no. latching	
		Plastic front ring	Metallized front ring	Plastic front ring	Metallized front ring
yes	transparent red	1.30.240.005/13xx	-	-	-
yes	transparent yellow	1.30.240.005/14xx	-	-	-
yes	transparent green	1.30.240.005/15xx	-	-	-
yes	transparent blue	1.30.240.005/16xx	-	-	-
yes	transparent white	1.30.240.005/10xx	-	-	-
no	opaque red	1.30.240.105/03xx	-	-	-
no	opaque yellow	1.30.240.105/04xx	-	-	-
no	opaque green	1.30.240.105/05xx	-	-	-
no	opaque blue	1.30.240.105/06xx	-	-	-
no	opaque white	1.30.240.105/02xx	-	-	-
no	opaque slate-grey	1.30.240.105/07xx	-	-	-
no	opaque black	1.30.240.105/01xx	-	-	-

CONTROL COMPONENTS

RAFIX 22 QR - ACTUATORS AND INDICATORS

– Table (continued) –

RAFIX 22 QR - Pushbutton with protective cap, flush lens, round collar

Pushbutton with protective cap for use under rugged conditions.

Legending on request.

xx = color of front ring: black = 01, silver grey = 08

Accessoires:

Label holder, round collar, with adhesive tape and release liner on back 50 x 30 x 3.6 mm: 5.07620.010/0000

Protective cover, suitable for pushbuttons with flush lens: see page 2 - 147



RAFIX 22 QR Pushbutton with protective cap, flush lens, square collar

Technical data see page 2 - 98

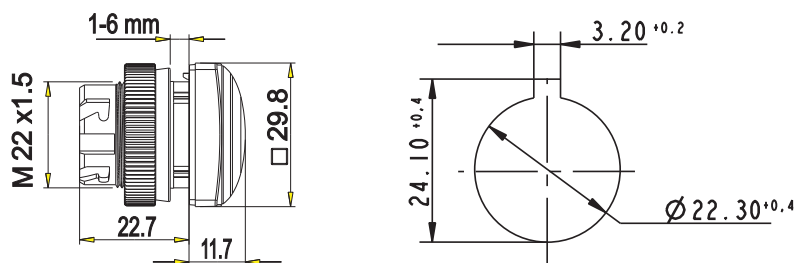

Panel cut-out to IEC 60947-5-1

→ Illumination	Color of lens	Order no. momentary		Order no. latching	
		Plastic front ring	Metallized front ring	Plastic front ring	Metallized front ring
yes	transparent red	1.30.240.055/13xx	-	-	-
yes	transparent yellow	1.30.240.055/14xx	-	-	-
yes	transparent green	1.30.240.055/15xx	-	-	-
yes	transparent blue	1.30.240.055/16xx	-	-	-
yes	transparent white	1.30.240.055/10xx	-	-	-
no	opaque red	1.30.240.155/03xx	-	-	-
no	opaque yellow	1.30.240.155/04xx	-	-	-
no	opaque green	1.30.240.155/05xx	-	-	-
no	opaque blue	1.30.240.155/06xx	-	-	-
no	opaque white	1.30.240.155/02xx	-	-	-
no	opaque slate-grey	1.30.240.155/07xx	-	-	-
no	opaque black	1.30.240.155/01xx	-	-	-

Pushbutton with protective cap for use under rugged conditions.

Legending on request.

xx = color of front ring: black = 01, silver grey = 08

Accessoires:

Label holder, square collar, with adhesive tape and release liner on back 50 x 30 x 3.6 mm: 5.07620.011/0000

RAFIX 22 QR Selector switches

→ The illuminated selector switches are provided with translucent handle markings. These are opaque on the non-illuminated versions. For colored illumination of the translucent handle marking please use contact blocks with lamp sockets and colored LED BA9s (see chapter 5 Accessories).

Technical Data

→ General information

Actuator	handle
Marking of handle	white
Color of front ring	see order block
Form of collar	see order block

→ Dimensions

Dimensions of collar	see order block
Overall height	22.2 mm
Mounting depth with contact block without cable	56.4 mm
Mounting hole	Ø 22.3 mm
Mounting grid	50 x 30 mm

→ Mechanical design

Mounting	ring nut
Contact function	see order block
Illumination	see order block
Rotating angle	see order block

→ Mechanical characteristics

Operating force max.	approx. 5 N for 1 switching element
Torque max.	2 Nm

→ Electrical characteristics

Protection class	II
------------------	----

→ Other specifications

Operating life (operations)	500,000
Degree of protection from front side	IP65 (DIN EN 60529)
Ambient temp. operating min.	-25 °C
Ambient temp. operating max.	+70 °C
Storage temperature min.	-40 °C
Storage temperature max.	+80 °C
Environmental resistance	acc. to IEC 60068-2-14, -30, -33 and -78
ROHS compliant	yes
REACH compliant	yes

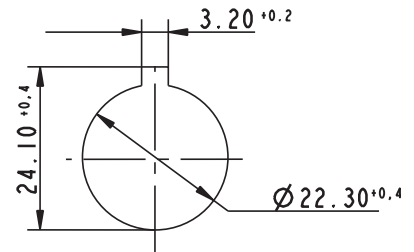

Panel cut-out to IEC 60947-5-1

Approvals

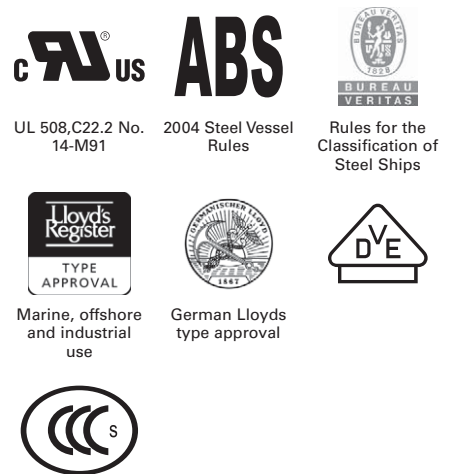



Accessories RAFIX 22 QR - Selector switch

→ Description	Photo	Order no.	Additional accessories see page
BA 9s base (MBC/MCC), filament lamps, shape A, DIN 49851		-	5 - 11
RAFIX - Insulating housing IP65, Ø 22.3 mm		-	2 - 79, 2 - 148, 5 - 20
RAFIX 22 QR - Contact blocks with gold contacts		-	2 - 138

CONTROL COMPONENTS

RAFIX 22 QR - ACTUATORS AND INDICATORS

– Table (continued) –
Accessories RAFIX 22 QR - Selector switch

→ Description	Photo	Order no.	Additional accessories see page
RAFIX 22 QR - Contact blocks with silver contacts		-	2 - 135
Socket BA 9s (MBC/MCC), LED superbright		-	5 - 8
Fixing spanner for ring nut		5.05.800.062/0000	2 - 145, 2 - 261, 5 - 25







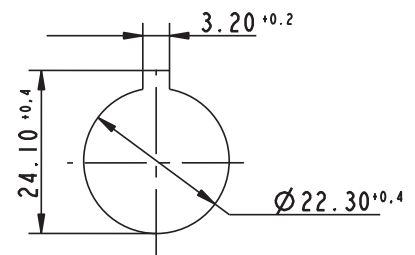
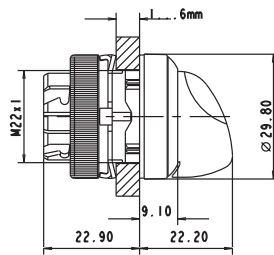

RAFIX 22 QR Selector switch, round collar, short handle

Technical data see page 2 - 101



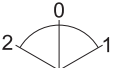
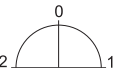
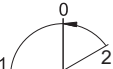





Panel cut-out to IEC 60947-5-1

→ Illumination	Contact function	Rotating angle	Diagram	Order no.	
				Plastic front ring	Metallized front ring
yes	momentary	1 x 40°		1.30.242.001/22xx	1.30.242.002/2200
yes	momentary	2 x 40°		1.30.242.026/22xx	1.30.242.027/2200
yes	latching	1 x 90°, form L		1.30.242.101/22xx	1.30.242.102/2200
yes	latching	1 x 90°, form V		1.30.242.201/22xx	1.30.242.202/2200
yes	latching	2 x 60°		1.30.242.301/22xx	1.30.242.302/2200
yes	latching	2 x 90°		1.30.242.126/22xx	1.30.242.127/2200
yes	latching 1 x 90° and momentary 1 x 40°	1 x 90° and 1 x 40°		1.30.242.426/22xx	1.30.242.427/2200
no	momentary	1 x 40°		1.30.242.501/02xx	1.30.242.502/0200

2

RAFIX
22 QR

– Table (continued) –
RAFIX 22 QR - Selector switch, round collar, short handle

→ Illumination	Contact function	Rotating angle		Order no.	
				Plastic front ring	Metallized front ring
no	momentary	2 x 40°		1.30.242.526/02xx	1.30.242.527/0200
no	latching	1 x 90°, form L		1.30.242.601/02xx	1.30.242.602/0200
no	latching	1 x 90°, form V		1.30.242.701/02xx	1.30.242.702/0200
no	latching	2 x 60°		1.30.242.801/02xx	1.30.242.802/0200
no	latching	2 x 90°		1.30.242.626/02xx	1.30.242.627/0200
no	latching 1 x 90° and momentary 1 x 40°	1 x 90° and 1 x 40°		1.30.242.926/02xx	1.30.242.927/0200

xx = Front ring color: black = 01, slate grey = 07, silver grey = 08; other colors on request.

Included: Ring nut with claw.

At keylock switches with 3 switching positions (e.g. 2 x 90 degrees), either the left-hand or right-hand contact block is activated, depending on the sense of rotation.

Accessoires:

Label holder, round collar, with adhesive tape and release liner on back 50 x 30 x 3.6 mm: 5.07.620.010/0000

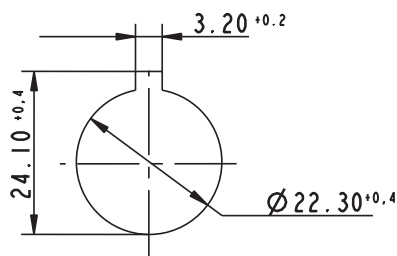
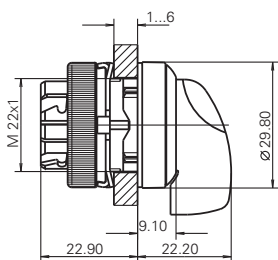

RAFIX 22 QR Selector switch, round collar, long handle

Technical data see page 2 - 101



Panel cut-out to IEC 60947-5-1









→ Illumination	Contact function	Rotating angle		Order no.	
				Plastic front ring	Metallized front ring
yes	momentary	1 x 40°		1.30.242.011/22xx	1.30.242.012/2200
yes	momentary	2 x 40°		1.30.242.036/22xx	1.30.242.037/2200

CONTROL COMPONENTS

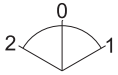
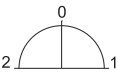
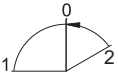
RAFIX 22 QR - ACTUATORS AND INDICATORS

– Table (continued) –
RAFIX 22 QR - Selector switch, round collar, long handle

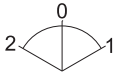
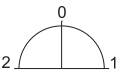
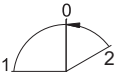
→ Illumination	Contact function	Rotating angle		Order no.	
				Plastic front ring	Metallized front ring
yes	latching	1 x 90°, form L		1.30.242.111/22xx	1.30.242.112/2200
yes	latching	1 x 90°, form V		1.30.242.211/22xx	1.30.242.212/2200
yes	latching	2 x 60°		1.30.242.311/22xx	1.30.242.312/2200
yes	latching	2 x 90°		1.30.242.136/22xx	1.30.242.137/2200
yes	latching 1 x 90° and momentary 1 x 40°	1 x 90° and 1 x 40°		1.30.242.436/22xx	1.30.242.437/2200
no	momentary	1 x 40°		1.30.242.511/02xx	1.30.242.512/0200
no	momentary	2 x 40°		1.30.242.536/02xx	1.30.242.537/0200
no	latching	1 x 90°, form L		1.30.242.611/02xx	1.30.242.612/0200
no	latching	1 x 90°, form V		1.30.242.711/02xx	1.30.242.712/0200
no	latching	2 x 60°		1.30.242.811/02xx	1.30.242.812/0200
no	latching	2 x 90°		1.30.242.636/02xx	1.30.242.637/0200
no	latching 1 x 90° and momentary 1 x 40°	1 x 90° and 1 x 40°		1.30.242.936/02xx	1.30.242.937/0200

xx = Front ring color: black = 01, slate grey = 07, silver grey = 08; other colors on request.

Included: Ring nut with claw.

At selector switches with 3 switching positions (e.g. 2 x 90 degrees), either the left-hand or right-hand contact block is activated, depending on the sense of rotation.

Accessoires:

Label holder, round collar, with adhesive tape and release liner on back 50 x 30 x 3.6 mm: 5.07620.010/0000

RAFIX 22 QR Selector switch, square collar, short handle

Technical data see page 2 - 101

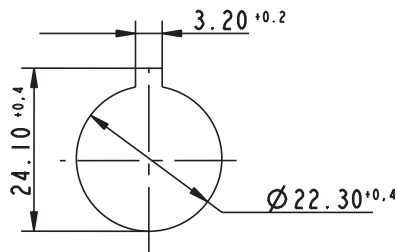
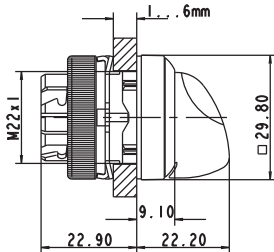

Panel cut-out to IEC 60947-5-1



→ Illumination	Contact function	Rotating angle		Order no.	
				Plastic front ring	Metallized front ring
yes	momentary	1 x 40°		1.30.242.051/22xx	1.30.242.052/2200
yes	momentary	2 x 40°		1.30.242.076/22xx	1.30.242.077/2200
yes	latching	1 x 90°, form L		1.30.242.151/22xx	1.30.242.152/2200
yes	latching	1 x 90°, form V		1.30.242.251/22xx	1.30.242.252/2200
yes	latching	2 x 60°		1.30.242.351/22xx	1.30.242.352/2200
yes	latching	2 x 90°		1.30.242.176/22xx	1.30.242.177/2200
yes	latching 1 x 90° and momentary 1 x 40°	1 x 90° and 1 x 40°		1.30.242.476/22xx	1.30.242.477/2200
no	momentary	1 x 40°		1.30.242.551/02xx	1.30.242.552/0200
no	momentary	2 x 40°		1.30.242.576/02xx	1.30.242.577/0200
no	latching	1 x 90°, form L		1.30.242.651/02xx	1.30.242.652/0200
no	latching	1 x 90°, form V		1.30.242.751/02xx	1.30.242.752/0200
no	latching	2 x 60°		1.30.242.851/02xx	1.30.242.852/0200
no	latching	2 x 90°		1.30.242.676/02xx	1.30.242.677/0200
no	latching 1 x 90° and momentary 1 x 40°	1 x 90° and 1 x 40°		1.30.242.976/02xx	1.30.242.977/0200

CONTROL COMPONENTS

RAFIX 22 QR - ACTUATORS AND INDICATORS

– Table (continued) –

RAFIX 22 QR - Selector switch, square collar, short handle

xx = Front ring color: black = 01, slate grey = 07, silver grey = 08; other colors on request.

Included: Ring nut with claw.

At selector switches with 3 switching positions (e.g. 2 x 90 degrees), either the left-hand or right-hand contact block is activated, depending on the sense of rotation.

Accessoires:

Label holder, square collar, with adhesive tape and release liner on back 50 x 30 x 3.6 mm: 5.07620.011/0000



RAFIX 22 QR Selector switch, square collar, long handle

Technical data see page 2 - 101

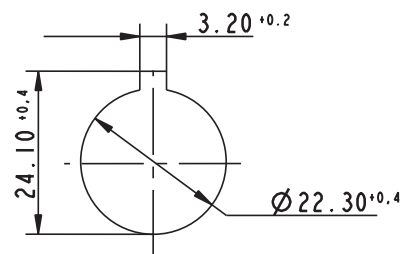
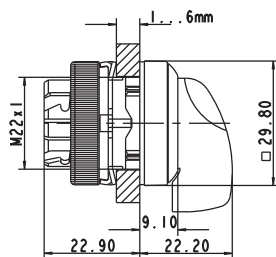

Panel cut-out to IEC 60947-5-1

→ Illumination	Contact function	Rotating angle		Order no.	
				Plastic front ring	Metallized front ring
yes	momentary	1 x 40°		1.30.242.061/22xx	1.30.242.062/2200
yes	momentary	2 x 40°		1.30.242.086/22xx	1.30.242.087/2200
yes	latching	1 x 90°, form L		1.30.242.161/22xx	1.30.242.162/2200
yes	latching	1 x 90°, form V		1.30.242.261/22xx	1.30.242.262/2200
yes	latching	2 x 60°		1.30.242.361/22xx	1.30.242.362/2200
yes	latching	2 x 90°		1.30.242.186/22xx	1.30.242.187/2200
yes	latching 1 x 90° and momentary 1 x 40°	1 x 90° and 1 x 40°		1.30.242.486/22xx	1.30.242.487/2200
no	momentary	1 x 40°		1.30.242.561/02xx	1.30.242.562/0200
no	momentary	2 x 40°		1.30.242.586/02xx	1.30.242.587/0200
no	latching	1 x 90°, form L		1.30.242.661/02xx	1.30.242.662/0200

CONTROL COMPONENTS

RAFIX 22 QR - ACTUATORS AND INDICATORS

– Table (continued) –
RAFIX 22 QR - Selector switch, square collar, long handle

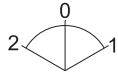
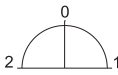
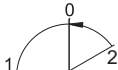
→ Illumination	Contact function	Rotating angle		Order no.	
				Plastic front ring	Metallized front ring
no	latching	1 x 90°, form V		1.30.242.761/02xx	1.30.242.762/0200
no	latching	2 x 60°		1.30.242.861/02xx	1.30.242.862/0200
no	latching	2 x 90°		1.30.242.686/02xx	1.30.242.687/0200
no	latching 1 x 90° and momentary 1 x 40°	1 x 90° and 1 x 40°		1.30.242.986/02xx	1.30.242.987/0200

xx = Front ring color: black = 01, slate grey = 07, silver grey = 08; other colors on request.

Included: Ring nut with claw.

At selector switches with 3 switching positions (e.g. 2 x 90 degrees), either the left-hand or right-hand contact block is activated, depending on the sense of rotation.

Accessoires:

Label holder, square collar, with adhesive tape and release liner on back 50 x 30 x 3.6 mm: 5.07.620.011/0000

2

RAFIX
22 QR

CONTROL COMPONENTS

RAFIX 22 QR - ACTUATORS AND INDICATORS



RAFIX 22 QR Keylock switches

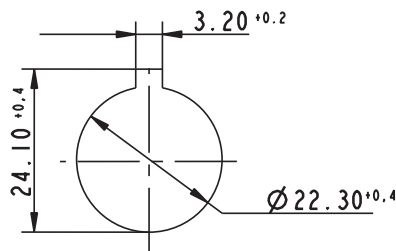

Panel cut-out to IEC 60947-5-1

2

Approvals



UL 508, C22.2
No. 14-M91



2004 Steel Vessel
Rules



Rules for the
Classification of
Steel Ships



Marine, offshore
and industrial
use



Type approval



→ The locking systems we use are created according to DIN EN 1303 by leading lock manufacturers. They are open, mechanical systems that require occasional maintenance of the machinery or plant operator depending on environmental conditions.

Technical Data

→ General information

Actuator	Key
Color of front ring	see order block
Form of collar	see order block

→ Dimensions

Dimensions of collar	see order block
Overall height	30.6 mm
Mounting depth with contact block without cable	56.4 mm
Mounting hole	Ø 22.3 mm
Mounting grid	50 x 30 mm

→ Mechanical design

Mounting	ring nut
Contact function	see order block
Illumination	no
Lock	RONIS
Wafers	4
Lock type	see order block
Main key	no
Symmetric key	no
Rotating angle	see order block
Key removal position	see order block

→ Mechanical characteristics

Operating force max.	approx. 5 N for 1 switching element
Torque max.	2 Nm

→ Electrical characteristics

Protection class	II
------------------	----

→ Other specifications

Operating life (operations)	300,000 momentary / 50,000 latching
Degree of protection from front side	IP65 (DIN EN 60529)
Ambient temp. operating min.	-25 °C
Ambient temp. operating max.	+70 °C
Storage temperature min.	-40 °C
Storage temperature max.	+80 °C
Environmental resistance	acc. to IEC 60068-2-14, -30, -33 and -78
ROHS compliant	yes
REACH compliant	yes

Accessories RAFIX 22 QR - Keylock switch

→ Description	Photo	Order no.	Additional accessories see page
RAFIX - Insulating housing IP65, Ø 22.3 mm		-	2 - 79, 2 - 148, 5 - 20
RAFIX 22 QR - Contact blocks with gold contacts		-	2 - 138
RAFIX 22 QR - Contact blocks with silver contacts		-	2 - 135
Fixing spanner for ring nut		5.05.800.062/0000	2 - 145, 2 - 261, 5 - 25
Spare key RONIS 455, delivery content 2 keys		5.58.017.001/0000	-
Spare key RONIS 1122E, delivery content 2 keys		5.58.017.403/0000	-
Spare key RONIS 421, delivery content 2 keys		5.58.017.421/0000	-



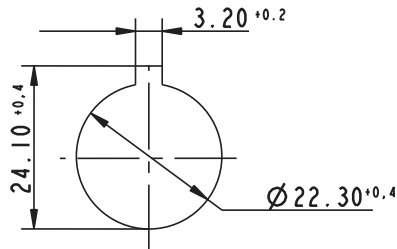
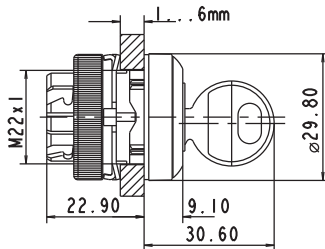

RAFIX 22 QR Keylock switch, round collar

Technical data see page 2 - 108



Panel cut-out to IEC 60947-5-1

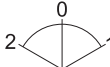

→ Lock type	Rotating angle	Contact function	Key removal position	Rotating angle	Order no.	
					Plastic front ring	Metallized front ring
421	1 x 40°	momentary	0		1.30.245.003/xxxx	1.30.245.004/0000
421	2 x 40°	momentary	0		1.30.245.103/xxxx	1.30.245.104/0000
421	1 x 90°, form L	latching	0		1.30.245.203/xxxx	1.30.245.204/0000
421	1 x 90°, form V	latching	0		1.30.245.303/xxxx	1.30.245.304/0000
421	1 x 90°, form V	latching	0+1		1.30.245.323/xxxx	1.30.245.324/0000
421	2 x 60°	latching	0+1+2		-	1.30.245.734/0000

CONTROL COMPONENTS

RAFIX 22 QR - ACTUATORS AND INDICATORS

– Table (continued) –
RAFIX 22 QR - Keylock switch, round collar

→ Lock type	Rotating angle	Contact function	Key removal position	Rotating angle	Order no.	
					Plastic front ring	Metallized front ring
421	2 x 90°	latching	0		1.30.245.403/xxxx	1.30.245.404/0000
421	2 x 90°	latching	0+1+2		1.30.245.433/xxxx	1.30.245.434/0000
421	1 x 90° and 1 x 40°	latching 1 x 90° and momentary 1 x 40°	0+2		-	1.30.245.524/0000
455	1 x 40°	momentary	0		1.30.245.001/xxxx	1.30.245.002/0000
455	2 x 40°	momentary	0		1.30.245.101/xxxx	1.30.245.102/0000
455	1 x 90°, form L	latching	0		1.30.245.201/xxxx	1.30.245.202/0000
455	1 x 90°, form L	latching	0+1		1.30.245.221/xxxx	1.30.245.222/0000
455	1 x 90°, form V	latching	0		1.30.245.301/xxxx	1.30.245.302/0000
455	1 x 90°, form V	latching	0+1		1.30.245.321/xxxx	1.30.245.322/0000
455	2 x 60°	latching	0+1+2		1.30.245.731/xxxx	1.30.245.732/0000
455	2 x 90°	latching	0+1+2		1.30.245.431/xxxx	1.30.245.432/0000
455	2 x 90°	latching	0		1.30.245.401/xxxx	1.30.245.402/0000
455	1 x 90° and 1 x 40°	latching 1 x 90° and momentary 1 x 40°	0		-	1.30.245.502/0000
455	1 x 90° and 1 x 40°	latching 1 x 90° and momentary 1 x 40°	0+2		-	1.30.245.522/0000
1122E	1 x 40°	momentary	0		1.30.245.005/xxxx	1.30.245.006/0000
1122E	2 x 40°	momentary	0		1.30.245.105/xxxx	1.30.245.106/0000
1122E	1 x 90°, form L	latching	0		1.30.245.205/xxxx	1.30.245.206/0000
1122E	1 x 90°, form V	latching	0		1.30.245.305/xxxx	1.30.245.306/0000
1122E	1 x 90°, form V	latching	0+1		1.30.245.325/xxxx	1.30.245.326/0000
1122E	2 x 90°	latching	0		1.30.245.405/xxxx	1.30.245.406/0000

2

RAFIX
22 QR

– Table (continued) –
RAFIX 22 QR - Keylock switch, round collar

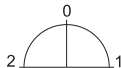
→ Lock type	Rotating angle	Contact function	Key removal position	Rotating angle	Order no.	
					Plastic front ring	Metallized front ring
1122E	2 x 90°	latching	0+1+2		1.30.245.435/xxxx	1.30.245.436/0000

xxxx = Front ring color: black = 0100, slate grey = 0700, silver grey = 0800.
Other versions on request.

Included: Ring nut with claw.

On selector switches with 3 switching positions (e.g. 2 x 90 degrees), either the left-hand or right-hand contact block is activated, depending on the sense of rotation.

Accessoires:

Label holder, round collar, with adhesive tape and release liner on back 50 x 30 x 3.6 mm: 5.07.620.010/0000



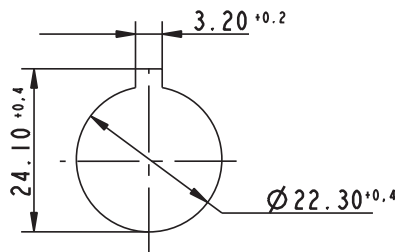
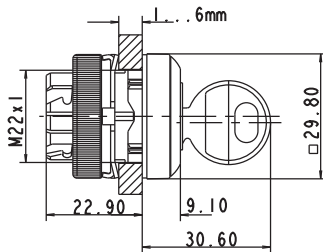

RAFIX 22 QR Keylock switch, square collar

Technical data see page 2 - 108



Panel cut-out to IEC 60947-5-1



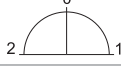
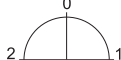















→ Lock type	Rotating angle	Contact function	Key removal position	Rotating angle	Order no.	
					Plastic front ring	Metallized front ring
421	1 x 40°	momentary	0		1.30.245.053/xxxx	1.30.245.054/0000
421	2 x 40°	momentary	0		1.30.245.153/xxxx	1.30.245.154/0000
421	1 x 90°, form L	latching	0		1.30.245.253/xxxx	1.30.245.254/0000
421	1 x 90°, form V	latching	0		1.30.245.353/xxxx	1.30.245.354/0000
421	1 x 90°, form V	latching	0+1		-	1.30.245.374/0000
421	2 x 90°	latching	0		1.30.245.453/xxxx	1.30.245.454/0000
421	2 x 90°	latching	0+1+2		1.30.245.483/xxxx	1.30.245.484/0000

CONTROL COMPONENTS

RAFIX 22 QR - ACTUATORS AND INDICATORS

– Table (continued) –
RAFIX 22 QR - Keylock switch, square collar

→ Lock type	Rotating angle	Contact function	Key removal position	Rotating angle	Order no.	
					Plastic front ring	Metallized front ring
455	1 x 40°	momentary	0		1.30.245.051/xxxx	1.30.245.052/0000
455	2 x 40°	momentary	0		1.30.245.151/xxxx	1.30.245.152/0000
455	1 x 90°, form L	latching	0		1.30.245.251/xxxx	1.30.245.252/0000
455	1 x 90°, form L	latching	0+1		1.30.245.271/xxxx	1.30.245.272/0000
455	1 x 90°, form V	latching	0		1.30.245.351/xxxx	1.30.245.352/0000
455	1 x 90°, form V	latching	0+1		1.30.245.371/xxxx	1.30.245.372/0000
455	2 x 60°	latching	0+1+2		1.30.245.781/xxxx	1.30.245.782/0000
455	2 x 90°	latching	0+1+2		1.30.245.481/xxxx	1.30.245.482/0000
455	2 x 90°	latching	0		1.30.245.451/xxxx	1.30.245.452/0000
455	1 x 90° and 1 x 40°	latching 1 x 90° and momentary 1 x 40°	0+2		-	1.30.245.572/0000
1122E	1 x 40°	momentary	0		1.30.245.055/xxxx	1.30.245.056/0000
1122E	2 x 40°	momentary	0		1.30.245.155/xxxx	1.30.245.156/0000
1122E	1 x 90°, form L	latching	0		1.30.245.255/xxxx	1.30.245.256/0000
1122E	1 x 90°, form V	latching	0		1.30.245.355/xxxx	1.30.245.356/0000
1122E	1 x 90°, form V	latching	0+1		1.30.245.375/xxxx	1.30.245.376/0000
1122E	2 x 90°	latching	0		1.30.245.455/xxxx	1.30.245.456/0000
1122E	2 x 90°	latching	0+1+2		1.30.245.485/xxxx	1.30.245.486/0000

xxxx = Front ring color: black = 0100, slate grey = 0700, silver grey = 0800.

Other versions on request.

Included: Ring nut with claw.

On keylock switches with 3 switching positions (e.g. 2 x 90 degrees), either the left-hand or right-hand contact block is activated, depending on the sense of rotation.

CONTROL COMPONENTS

RAFIX 22 QR - ACTUATORS AND INDICATORS

– Table (continued) –
RAFIX 22 QR - Keylock switch, square collar

Accessoires:

Label holder, square collar, with adhesive tape and release liner on back 50 x 30 x 3.6 mm: 5.07.620.011/0000

2

RAFIX
22 QR

CONTROL COMPONENTS

RAFIX 22 QR - ACTUATORS AND INDICATORS



RAFIX 22 QR Mushroom-headed pushbuttons

Technical Data

→ General information

Actuator	mushroom
Color of mushroom	see order block
Color of front ring	see order block
Form of collar	see order block

→ Dimensions

Dimensions of collar	see order block
Overall height	20.1 mm
Mounting depth	56.4 mm
Mounting hole	Ø 22.3 mm
Mounting grid	50 x 30 mm

→ Mechanical design

Mounting	ring nut
Contact function	see order block
Illuminability	see order block

→ Mechanical characteristics

Operating force max.	approx. 5 N for 1 switching element
Robustness max.	100 N

→ Electrical characteristics

Protection class	-
------------------	---

→ Other specifications

Operating life (operations)	1,000,000
Degree of protection from front side	IP65 (DIN EN 60529)
Ambient temp. operating min.	-25 °C
Ambient temp. operating max.	+70 °C
Storage temperature min.	-40 °C
Storage temperature max.	+80 °C
Environmental resistance	acc. to IEC 60068-2-14, -30, -33 and -78
ROHS compliant	yes
REACH compliant	yes

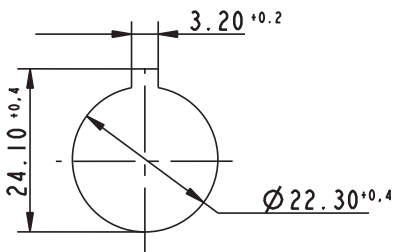

Panel cut-out to IEC 60947-5-1

Approvals



UL 508, C22.2 No. 14-M91



2004 Steel Vessel Rules



Rules for the Classification of Steel Ships



Marine, offshore and industrial use



German Lloyd's type approval



Accessories RAFIX 22 QR - Mushroom-headed pushbutton

→ Description	Photo	Order no.	Additional accessories see page
RAFIX - Insulating housing IP65, Ø 22.3 mm		-	2 - 79, 2 - 148, 5 - 20
RAFIX 22 QR - Contact blocks with gold contacts		-	2 - 138
RAFIX 22 QR - Contact blocks with silver contacts		-	2 - 135

– Table (continued) –
Accessories RAFIX 22 QR - Mushroom-headed pushbutton

→ Description	Photo	Order no.	Additional accessories see page
Fixing spanner for ring nut		5.05.800.062/0000	2 - 145, 2 - 261, 5 - 25

RAFIX 22 QR Mushroom-headed pushbutton 40 mm, round collar

Technical data see page 2 - 114

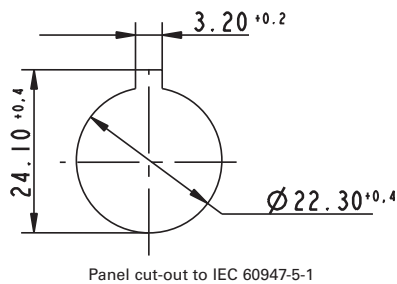
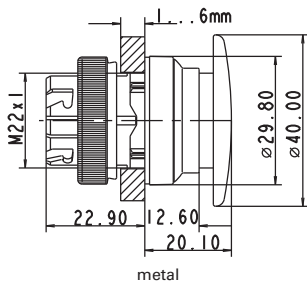

2

RAFIX
22 QR

→ Illuminability	Color of mushroom	Color of front ring	Contact function	Order no.
no	opaque red	plastic slate-grey	momentary	1.30.246.501/0307
no	opaque red	metal	momentary	1.30.246.502/0300
no	opaque black	plastic slate-grey	momentary	1.30.246.501/0107
no	opaque black	metal	momentary	1.30.246.502/0100

xx = Front ring color: slate grey = 07

CONTROL COMPONENTS

RAFIX 22 QR - ACTUATORS AND INDICATORS



RAFIX 22 QR Mushroom-headed pushbutton 40 mm, illuminated, round collar

Technical data see page 2 - 114

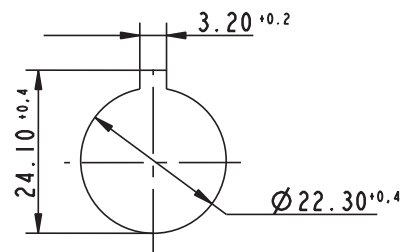
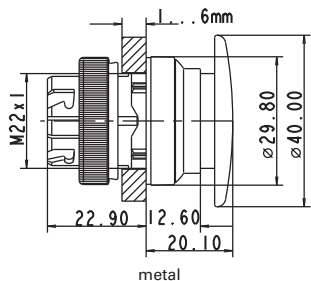

Panel cut-out to IEC 60947-5-1

→ Illuminability	Color of mushroom	Color of front ring	Contact function	Order no.
yes	opaque red/transparent red	plastic slate-grey	momentary	1.30.246.001/0307
yes	opaque red/transparent red	metal	momentary	1.30.246.002/0300

xx = Front ring color: slate grey = 07

Accessoires:

BA 9s base (MBC/MCC), filament lamp, shape A, DIN 49851: see page 5 - 11

Socket BA 9s (MBC/MCC), LED superbright: see page 5 - 8



RAFIX 22 QR Mushroom-headed pushbutton 40 mm, square collar

Technical data see page 2 - 114

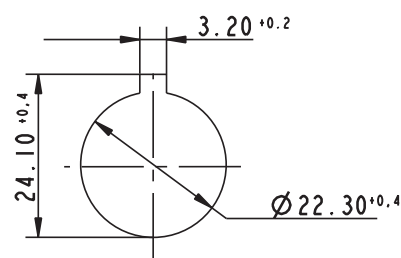
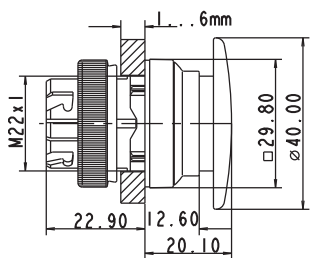

Panel cut-out to IEC 60947-5-1

→ Illuminability	Color of mushroom	Color of front ring	Contact function	Order no.
no	opaque red	plastic slate-grey	momentary	1.30.246.551/0307
no	opaque red	plastic slate-grey	momentary	1.30.246.551/0107
no	opaque red	plastic silber	momentary	1.30.246.551/0308
no	opaque red	metal	momentary	1.30.246.552/0300
no	opaque red	metal	momentary	1.30.246.552/0100

xx = Front ring color: slate grey = 07

RAFIX 22 QR Mushroom-headed pushbutton 40 mm, illuminated, square collar

Technical data see page 2 - 114

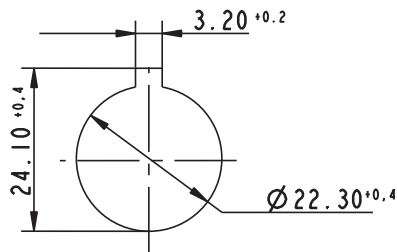
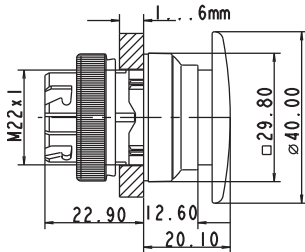

Panel cut-out to IEC 60947-5-1



→ Illuminability	Color of mushroom	Color of front ring	Contact function	Order no.
yes	opaque red/transparent red	plastic slate-grey	momentary	1.30.246.051/0307
yes	opaque red/transparent red	plastic silver-gray	momentary	1.30.246.051/0308
yes	opaque red/transparent red	metal	momentary	1.30.246.052/0300

xx = Front ring color: slate grey = 07

Accessoires:

BA 9s base (MBC/MCC), filament lamp, shape A, DIN 49851: see page 5 - 11
Socket BA 9s (MBC/MCC), LED superbright: see page 5 - 8

CONTROL COMPONENTS

RAFIX 22 QR - ACTUATORS AND INDICATORS



RAFIX 22 QR Emergency stop pushbuttons, dupe-proof to EN ISO 13850

2

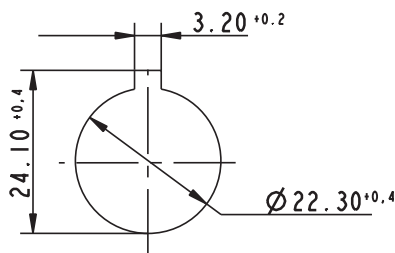
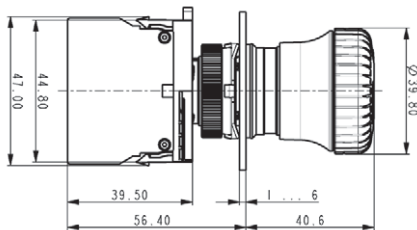

Panel cut-out to IEC 60947-5-1

→ The emergency stop pushbuttons comply with IEC 60 947 and VDE 0113 Part 1.

They are designed dupe-proof according to EN ISO 13850 with a positive mechanical movement sequence. A certain operating force must be exerted at the action point in order to prevent inadvertent operation.

The pushbutton latches when pressed.

The special shape of the actuator prevents the emergency stop pushbutton from being blocked. This means that the emergency stop process - once initiated - cannot be impeded by any jamming objects.

Original operating instructions see Appendix.

Technical Data

→ General information

Actuator	mushroom
Color of mushroom	see order block
Form of collar	round

→ Dimensions

Dimensions of collar	Ø 29.8 mm
Overall height	see order block
Mounting depth with contact block without cable	56.4 mm
Mounting hole	Ø 22.3 mm
Mounting grid	-

→ Mechanical design

Mounting	ring nut
Contact function	latching
Illuminability	see order block
Reset	see order block
Lock type	see order block

→ Mechanical characteristics

Entsperr-Kraft	see order block
Operating force max.	approx. 5 N for 1 switching element
Robustness max.	100 N
Robustness	acc. to IEC 60947-5-5

→ Other specifications

Operating life (operations)	see order block
Degree of protection from front side	see order block
Ambient temp. operating min.	-25 °C
Ambient temp. operating max.	+70 °C
Storage temperature min.	-40 °C
Storage temperature max.	+80 °C
Environmental resistance	acc. to IEC 60068-2-14, -30, -33 and -78
ROHS compliant	yes
REACH compliant	yes

Approvals



UL 508, C22.2
No. 14-M91



2004 Steel Vessel
Rules



Rules for the
Classification of
Steel Ships



Marine, offshore
and industrial
use



German Lloyds
type approval



Accessories RAFIX 22 QR - Emergency stop pushbutton, dupe-proof to EN ISO 13850

→ Description	Photo	Order no.	Additional accessories see page
Emergency stop label, Ø 22.3 mm		-	2 - 82, 2 - 149, 2 - 264, 5 - 21
RAFIX 22 QR - Contact blocks with gold contacts		-	2 - 138
RAFIX 22 QR - Contact blocks with silver contacts		-	2 - 135
RAFIX - Insulating housing, Ø 22.3 mm, IP65, 1-module, yellow/yellow		1.20.810.202/0000	2 - 79, 2 - 148, 5 - 20
Fixing spanner for ring nut		5.05.800.062/0000	2 - 145, 2 - 261, 5 - 25

RAFIX 22 QR Emergency stop pushbutton

Technical data see page 2 - 118

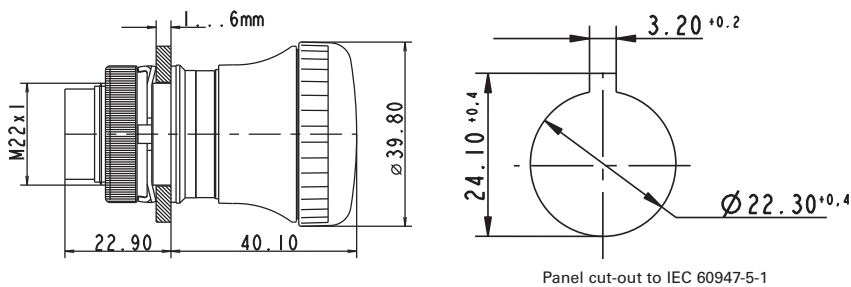

→ Degree of protection from front side	Reset	Illuminability	Operating life (operations)	Lock type	Order no.
IP65 (DIN EN 60529)	by clockwise rotation	no	100,000	-	1.30.243.501/0300

Included: Ring nut with claw.

Switching position indication: In the non-operated condition, a green ring is visible on the side.

For E-stop pushbuttons max. 2 contact block units may be used (eventually with multiple contacts). The middle coupling position may only be used for lamp sockets / LED elements.

CONTROL COMPONENTS

RAFIX 22 QR - ACTUATORS AND INDICATORS



RAFIX 22 QR Emergency stop pushbutton, with indication

Technical data see page 2 - 118

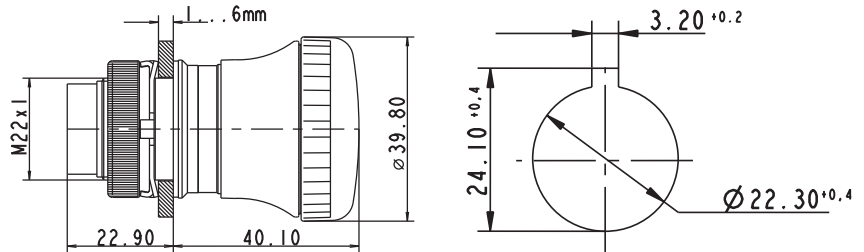

Panel cut-out to IEC 60947-5-1

→ Degree of protection from front side	Reset	Illuminability	Operating life (operations)	Lock type	Order no.
IP65 (DIN EN 60529)	by clockwise rotation	no	100,000	-	1.30.243.601/0300

Included: Ring nut with claw.

Switching position indication: In the non-operated condition, a green ring is visible on the side.

This switching position is visible in addition from the front; a mechanical indicator integrated into the mushroom head changes from green to red when actuated.

For E-stop pushbuttons max. 2 contact block units may be used (eventually with multiple contacts). The middle coupling position may only be used for lamp sockets / LED elements.

2

RAFIX
22 QR



RAFIX 22 QR Emergency stop pushbutton, with keylock

Technical data see page 2 - 118

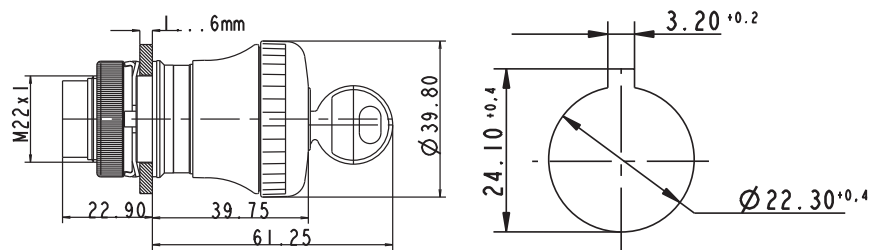

Panel cut-out to IEC 60947-5-1

→ Degree of protection from front side	Reset	Illuminability	Operating life (operations)	Lock type	Order no.
IP40 (DIN EN 60529)	by clockwise rotation	no	50,000	421	1.30.243.702/0300
IP40 (DIN EN 60529)	by clockwise rotation	no	50,000	455	1.30.243.701/0300
IP40 (DIN EN 60529)	by clockwise rotation	no	50,000	1122E	1.30.243.703/0300

Included: Ring nut with claw, 2 keys.

– Table (continued) –

RAFIX 22 QR - Emergency stop pushbutton, with keylock

Switching position indication: In the non-operated condition, a green ring is visible on the side.

Once actuated, the emergency stop pushbutton can only be reset with the key.

For E-stop pushbuttons max. 2 contact block units may be used (eventually with multiple contacts). The middle coupling position may only be used for lamp sockets / LED elements.

The locking systems we use are created according to DIN EN 1303 by leading lock manufacturers. They are open, mechanical systems that require occasional maintenance of the machinery or plant operator depending on environmental conditions.

Accessoires:

Spare key RONIS 1122E, delivery content 2 keys: 5.58.017403/0000

Spare key RONIS 421, delivery content 2 keys: 5.58.017421/0000

Spare key RONIS 455, delivery content 2 keys: 5.58.017001/0000

RAFIX 22 QR Emergency stop pushbutton, illuminable

Technical data see page 2 - 118

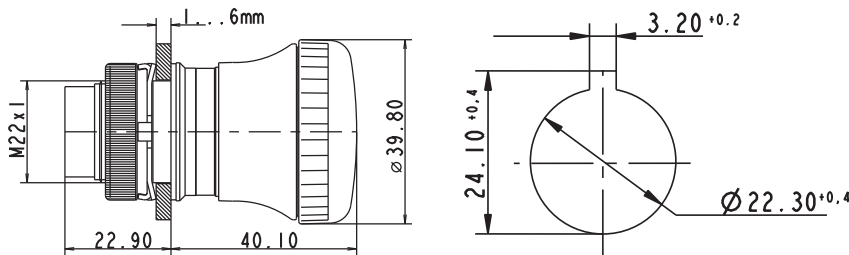

Panel cut-out to IEC 60947-5-1



→ Degree of protection from front side	Reset	Illuminability	Operating life (operations)	Lock type	Order no.
IP65 (DIN EN 60529)	by clockwise rotation	yes	100,000	-	1.30.243.001/0300

Included: Ring nut with claw.

Switching position indication: In the non-operated condition, a green ring is visible on the side.

For E-stop pushbuttons max. 2 contact block units may be used (eventually with multiple contacts). The middle coupling position may only be used for lamp sockets / LED elements.

Accessoires:

BA 9s base (MBC/MCC), filament lamp, shape A, DIN 49851: see page 5 - 11

Socket BA 9s (MBC/MCC), LED superbright: see page 5 - 8

CONTROL COMPONENTS

RAFIX 22 QR - ACTUATORS AND INDICATORS



RAFIX 22 QR Emergency stop pushbutton, reset by pulling

Technical data see page 2 - 118

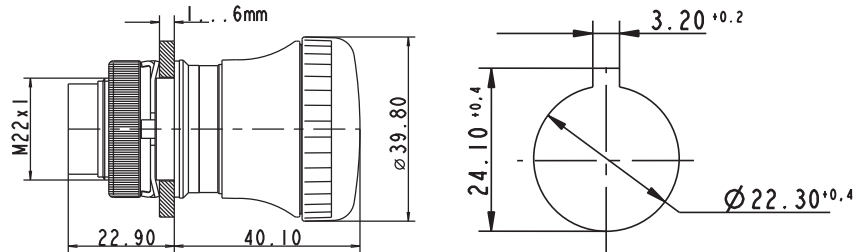

Panel cut-out to IEC 60947-5-1

→ Degree of protection from front side	Reset	Illuminability	Operating life (operations)	Lock type	Order no.
IP65 (DIN EN 60529)	by pulling	no	100,000	-	1.30.243.901/0300

Included: Ring nut with claw.

Switching position indication: In the non-operated condition, a green ring is visible on the side.

For E-stop pushbuttons max. 2 contact block units may be used (eventually with multiple contacts). The middle coupling position may only be used for lamp sockets / LED elements.

2

RAFIX
22 QR

RAFIX 22 QR Toggle switches

Technical Data

→ General information

Actuator	toggle
Color of toggle	opaque white
Color of front ring	see order block
Form of collar	see order block

→ Dimensions

Dimensions of collar	see order block
Overall height	22.2 mm
Mounting depth	56.4 mm
Mounting hole	Ø 22.3 mm
Mounting grid	50 x 30 mm

→ Mechanical design

Mounting	ring nut
Contact function	latching
Immuniability	no

→ Mechanical characteristics

Robustness max.	100 N
-----------------	-------

→ Electrical characteristics

Protection class	-
------------------	---

→ Other specifications

Operating life (operations)	100,000
Degree of protection	IP54 (DIN EN 60529)
Storage temperature min.	-40 °C
Storage temperature max.	+80 °C
Environmental resistance	acc. to IEC 60068-2-14, -30, -33 and -78
ROHS compliant	yes
REACH compliant	yes

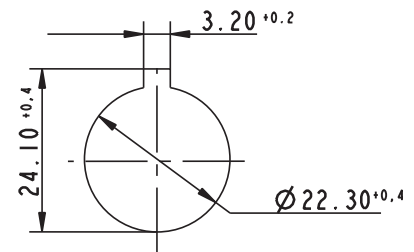

Panel cut-out to IEC 60947-5-1

2

RAFIX
22 QR

Approvals

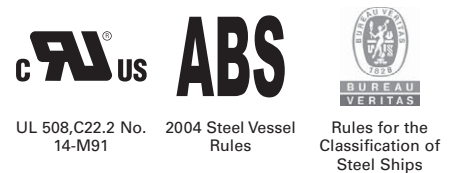

Marine, offshore and industrial use



German Lloyd's type approval



Accessories RAFIX 22 QR - Toggle switch

→ Description	Photo	Order no.	Additional accessories see page
RAFIX 22 QR - Contact block with gold contacts, with coupling, without lamp socket, screw terminals, 1 NC + 1 NO		1.20.124.117/0000	2 - 140
RAFIX 22 QR - Contact block with gold contacts, with coupling, without lamp socket, spring-type terminals, 1 NO		1.20.125.102/0000	2 - 140
Fixing spanner for ring nut		5.05.800.062/0000	2 - 145, 2 - 261, 5 - 25

CONTROL COMPONENTS

RAFIX 22 QR - ACTUATORS AND INDICATORS



RAFIX 22 QR Toggle switch, round collar

Technical data see page 2 - 123

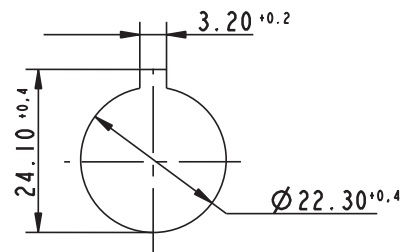
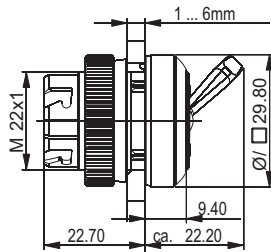

Panel cut-out to IEC 60947-5-1

2

→ Illuminability	Color of toggle	Color of front ring	Contact function	Order no.
no	opaque white	plastic black	latching	1.30.247.501/0201
no	opaque white	plastic slate-grey	latching	1.30.247.501/0207
no	opaque white	plastic silver-grey	latching	1.30.247.501/0208
no	opaque white	metal	latching	1.30.247.502/0200

xx = Front ring color: black = 01, slate grey = 07, silver grey = 08



RAFIX 22 QR Toggle switch, square collar

Technical data see page 2 - 123

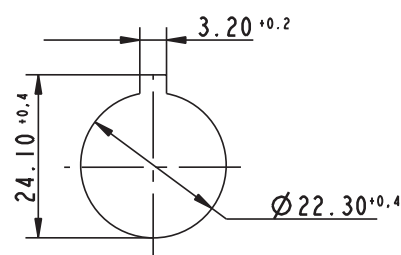
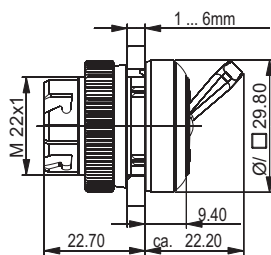

Panel cut-out to IEC 60947-5-1

→ Illuminability	Color of toggle	Color of front ring	Contact function	Order no.
no	opaque white	plastic black	latching	1.30.247.551/0201
no	opaque white	plastic slate-grey	latching	1.30.247.551/0207
no	opaque white	plastic silver-grey	latching	1.30.247.551/0208
no	opaque white	metal	latching	1.30.247.552/0200

xx = Front ring color: black = 01, slate grey = 07, silver grey = 08

RAFIX 22 QR Twin pushbuttons

→ Lens legends are oriented for vertical installation of the twin pushbutton. Only the signal indicator is illuminated on twin pushbuttons prepared for illumination. This area is opaque slate grey on versions which cannot be illuminated.

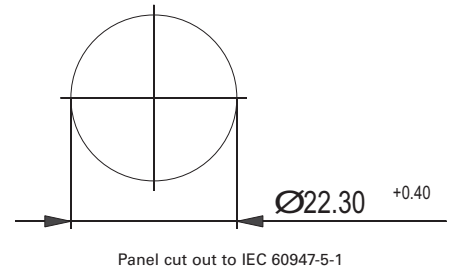

Technical Data

→ General information

Legending	see order block
Color of lens	opaque green/opaque red
Color of front ring	see order block
Form of collar	see order block

→ Dimensions

Dimensions of collar	59.6 x 29.8 mm
Overall height	9.1 mm
Mounting depth with contact block without cable	56.4 mm
Mounting hole	Ø 22.3 mm
Mounting grid	-

→ Mechanical design

Mounting	ring nut
Contact function	momentary
Illuminability	see order block

→ Mechanical characteristics

Operating force max.	approx. 5 N for 1 switching element
Robustness max.	100 N

→ Other specifications

Degree of protection from front side	IP65 (DIN EN 60529)
Ambient temp. operating min.	-25 °C
Ambient temp. operating max.	+70 °C
Storage temperature min.	-40 °C
Storage temperature max.	+80 °C
Environmental resistance	acc. to IEC 60068-2-14, -30, -33 and -78
ROHS compliant	yes
REACH compliant	yes

Approvals

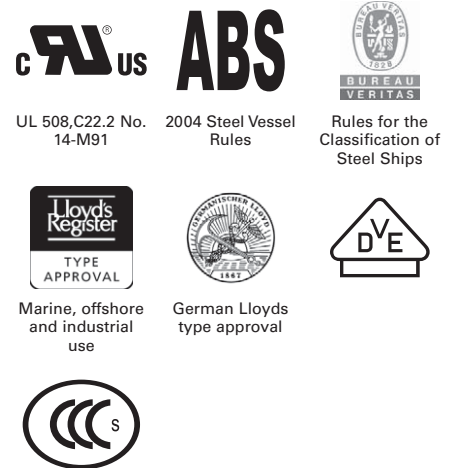

Accessories RAFIX 22 QR - Twin pushbutton

→ Description	Photo	Order no.	Additional accessories see page
RAFIX 22 QR - Contact block with silver contacts, with coupling and lamp socket, screw terminals, 1 NO, 1 NC		1.20.124.025/0000	-
RAFIX 22 QR - Contact block with gold contacts, with coupling and lamp socket, spring-type terminals, 1 NO, 1 NC		1.20.125.125/0000	-

For other contact blocks, refer to the chapter „Contact blocks“; for additional accessories, refer to „RAFIX 22 QR special accessories“

CONTROL COMPONENTS

RAFIX 22 QR - ACTUATORS AND INDICATORS



RAFIX 22 QR Twin pushbutton, oval collar

Technical data see page 2 - 125

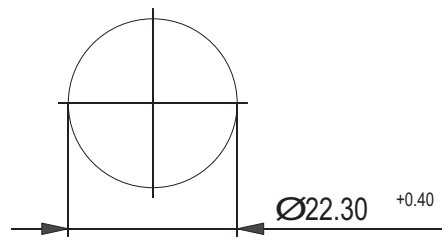
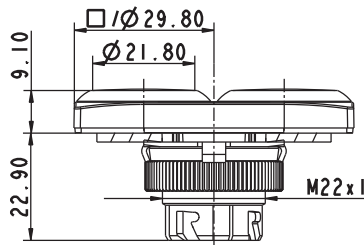

Panel cut out to IEC 60947-5-1

→ Illuminability	Color of lens	Legending	Color of front ring	Order no.
yes	opaque green/opaque red	none	slate-grey	1.30.241.001/2207
yes	opaque green/opaque red	red 0, green I	slate-grey	1.30.241.002/2207

Either the left-hand or right-hand contact block is actuated, depending on the button pressed. For illuminated versions the centre position of the coupling is reserved for the lamp socket. A third contact block arranged in the centre would be actuated by either button.



RAFIX 22 QR Twin pushbutton, rectangular collar

Technical data see page 2 - 125

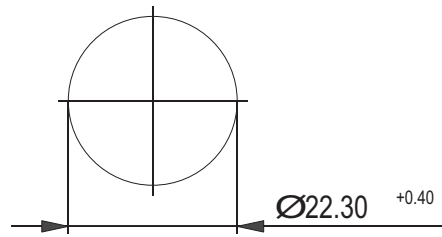
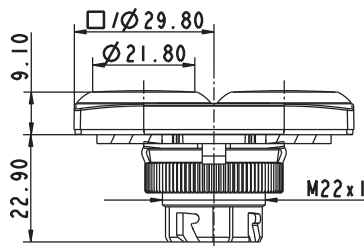

Panel cut out to IEC 60947-5-1

→ Illuminability	Color of lens	Legending	Color of front ring	Order no.
yes	opaque green/opaque red	none	slate-grey	1.30.241.051/2207
yes	opaque green/opaque red	red 0, green I	slate-grey	1.30.241.052/2207

Either the left-hand or right-hand contact block is actuated, depending on the button pressed. For illuminated versions the centre position of the coupling is reserved for the lamp socket. A third contact block arranged in the centre would be actuated by either button.

2

RAFIX
22 QR

RAFIX 22 QR Potentiometer drives



Technical Data

→ General information

Actuator	knob
Color of knob	see order block
Front ring	see order block
Form of collar	see order block

→ Dimensions

Dimensions of collar	see order block
Overall height	26.2 mm
Mounting depth	according to potentiometer
Mounting hole	Ø 22.3 mm
Mounting grid	50 x 30 mm

→ Mechanical design

Mounting	ring nut
----------	----------

→ Other specifications

Degree of protection from front side	IP65 (DIN EN 60529)
Storage temperature min.	-40 °C
Storage temperature max.	+80 °C
Environmental resistance	acc. to IEC 60068-2-14, -30, -33 and -78
ROHS compliant	yes
REACH compliant	yes

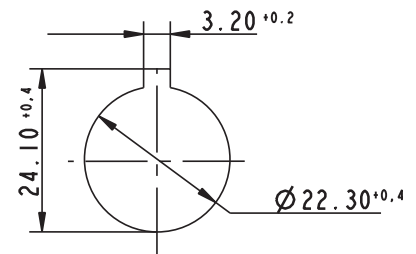

Panel cut-out to IEC 60947-5-1

2

RAFIX
22 QR

Approvals



2004 Steel Vessel
Rules



Rules for the
Classification of
Steel Ships



Marine, offshore
and industrial
use



German Lloyd's
type approval

Accessories RAFIX 22 QR - Potentiometer drive

→ Description

Description	Photo	Order no.	Additional accessories see page
Fixing spanner for ring nut		5.05.800.062/0000	2 - 145, 2 - 261, 5 - 25

CONTROL COMPONENTS

RAFIX 22 QR - ACTUATORS AND INDICATORS



RAFIX 22 QR Potentiometer drive, round collar

Technical data see page 2 - 127

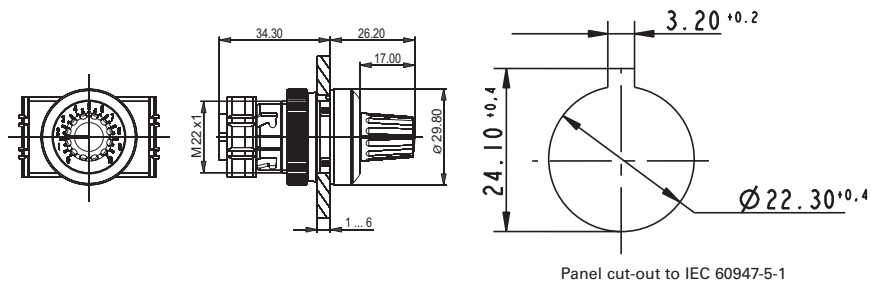

2

→ Front ring	Color of knob	Order no.
plastic slate-grey	opaque slate-grey	1.30.248.001/0700

For potentiometers with 6 mm shaft diameter and 50 mm shaft length. Potentiometer not included.

RAFIX
22 QR



RAFIX 22 QR Potentiometer drive, square collar

Technical data see page 2 - 127

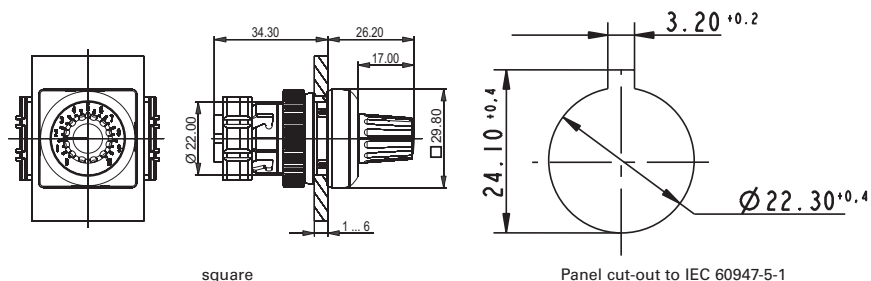

→ Front ring	Color of knob	Order no.
plastic slate-grey	opaque slate-grey	1.30.248.021/0700

For potentiometers with 6 mm shaft diameter and 50 mm shaft length. Potentiometer not included.

RAFIX 22 QR Buzzers

Technical Data

→ General information

Form of lens	flat lens
Color of lens	opaque slate-grey
Form of collar	see order block
Sound	see order block

→ Dimensions

Dimensions of collar	see order block
Overall height	9.8 mm
Mounting depth	56.4 mm
Mounting hole	Ø 22.3 mm
Mounting grid	50 x 30 mm

→ Mechanical design

Mounting	ring nut
----------	----------

→ Electrical characteristics

Operating voltage DC	see order block
Input current	see order block

→ Acoustic characteristics

Sonic pressure, 1 m distance min.	see order block
Sound frequency	see order block

→ Other specifications

Degree of protection from front side	IP65 (DIN EN 60529)
Storage temperature min.	-40 °C
Storage temperature max.	+80 °C
Environmental resistance	acc. to IEC 60068-2-14, -30, -33 and -78
ROHS compliant	yes
REACH compliant	yes

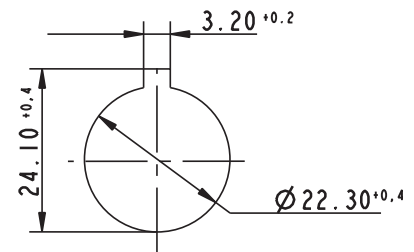

Panel cut-out to IEC 60947-5-1

2

RAFIX
22 QR

Approvals

ABS

2004 Steel Vessel
Rules



Rules for the
Classification of
Steel Ships



Marine, offshore
and industrial
use



German Lloyd's
type approval

Accessories RAFIX 22 QR - Buzzer

→ Description

Description	Photo	Order no.	Additional accessories see page
Fixing spanner for ring nut		5.05.800.062/0000	2 - 145, 2 - 261, 5 - 25

CONTROL COMPONENTS

RAFIX 22 QR - ACTUATORS AND INDICATORS



RAFIX 22 QR Buzzer, round collar

Technical data see page 2 - 129

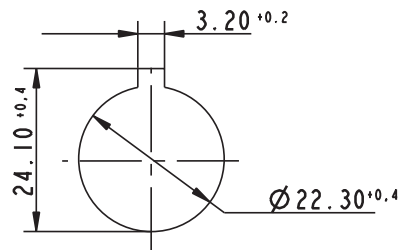
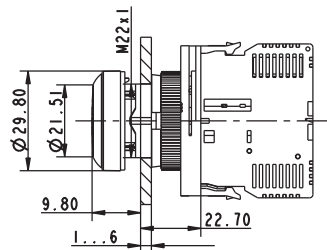

Panel cut-out to IEC 60947-5-1

2

→ Operating voltage DC	Input current	Sound	Sonic pressure, 1 m distance min.	Sound frequency	Order no.
12 V	25 mA	continuos beep	70 dB	2400 - 3100 Hz	1.30.249.002/0000
24 V	25 mA	continuos beep	70 dB	2400 - 3100 Hz	1.30.249.001/0000

RAFIX
22 QR



RAFIX 22 QR Buzzer, square collar

Technical data see page 2 - 129

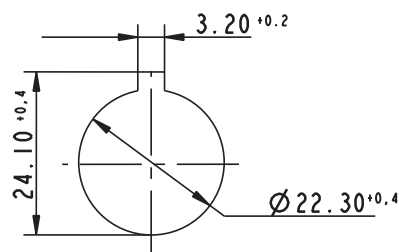
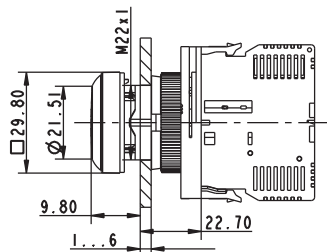

Panel cut-out to IEC 60947-5-1

→ Operating voltage DC	Input current	Sound	Sonic pressure, 1 m distance min.	Sound frequency	Order no.
12 V	25 mA	continuos beep	70 dB	2400 - 3100 Hz	1.30.249.022/0000
24 V	25 mA	continuos beep	70 dB	2400 - 3100 Hz	1.30.249.021/0000

RAFIX 22 QR Signal indicators

Technical Data

→ General information

Form of lens	see order block
Color of lens	see order block
Legend insert accommodation	see order block
Form of collar	see order block

→ Dimensions

Dimensions of collar	see order block
Overall height	see order block
Mounting depth	56.4 mm
Mounting hole	Ø 22.3 mm
Mounting grid	50 x 30 mm

→ Mechanical design

Mounting	ring nut
Illuminability	yes

→ Electrical characteristics

Protection class	-
------------------	---

→ Other specifications

Degree of protection from front side	IP65 (DIN EN 60529)
Ambient temp. operating min.	-25 °C
Ambient temp. operating max.	+70 °C
Storage temperature min.	-40 °C
Storage temperature max.	+80 °C
Environmental resistance	acc. to IEC 60068-2-14, -30, -33 and -78
ROHS compliant	yes
REACH compliant	yes

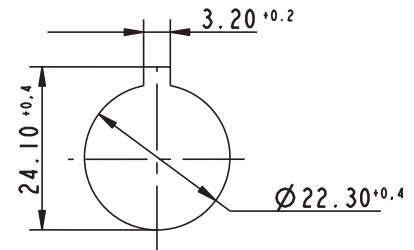

Panel cut-out to IEC 60947-5-1

2

RAFIX
22 QR

Approvals

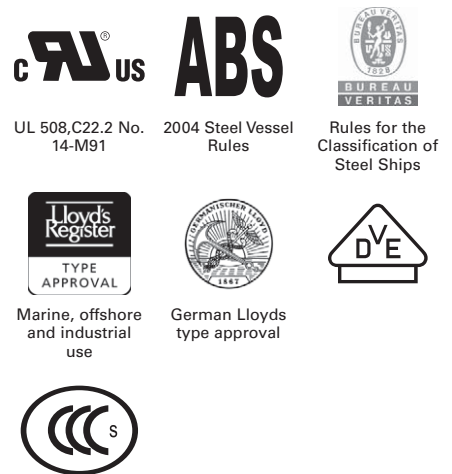



Accessories RAFIX 22 QR - Signal indicator

→ Description	Photo	Order no.	Additional accessories see page
BA 9s base (MBC/MCC), filament lamps, shape A, DIN 49851		-	5 - 11
RAFIX - Insulating housing IP65, Ø 22.3 mm		-	2 - 79, 2 - 148, 5 - 20
RAFIX 22 QR - Lamp sockets BA 9s (MBC/MCC)		-	2 - 141

CONTROL COMPONENTS

RAFIX 22 QR - ACTUATORS AND INDICATORS

– Table (continued) –
Accessories RAFIX 22 QR - Signal indicator

→ Description	Photo	Order no.	Additional accessories see page
RAFIX 22 QR - LED unit		-	2 - 143
Socket BA 9s (MBC/MCC), LED superbright		-	5 - 8
Fixing spanner for ring nut		5.05.800.062/0000	2 - 145, 2 - 261, 5 - 25

2

RAFIX 22 QR



RAFIX 22 QR Signal indicator, flat, round collar, for legend inserts

Technical data see page 2 - 131

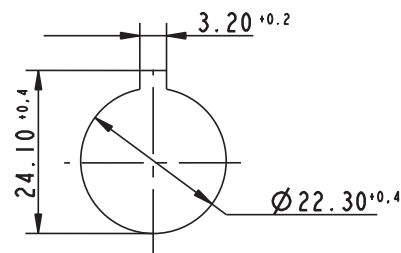
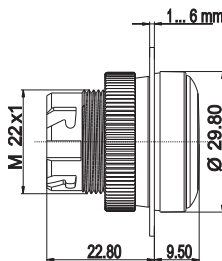

Panel cut-out to IEC 60947-5-1

→ Color of lens	Form of collar	Order no.
transparent red	round	1.74.505.501/1300
transparent yellow	round	1.74.505.501/1400
transparent green	round	1.74.505.501/1500
transparent blue	round	1.74.505.501/1600
transparent colorless	round	1.74.505.501/1000

Accessoires:

Legend insert without legend, use only in combination with transparent lenses.: 5.70.803.000/2000

RAFIX 22 QR Signal indicator, high, round collar

Technical data see page 2 - 131

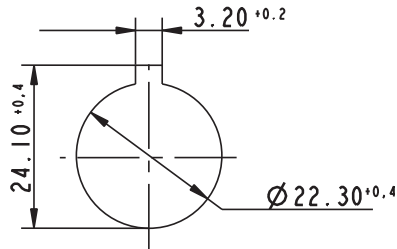
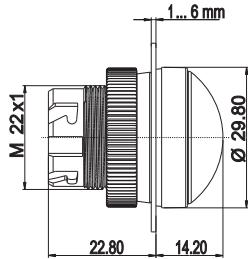

Panel cut-out to IEC 60947-5-1



→ Color of lens	Form of collar	Order no.
transparent red	round	1.74.505.511/1300
transparent yellow	round	1.74.505.511/1400
transparent green	round	1.74.505.511/1500
transparent blue	round	1.74.505.511/1600
transparent colorless	round	1.74.505.511/1000

2

RAFIX
22 QR

RAFIX 22 QR Signal indicator, flat, square collar, for legend inserts

Technical data see page 2 - 131

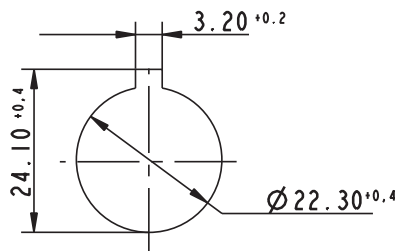
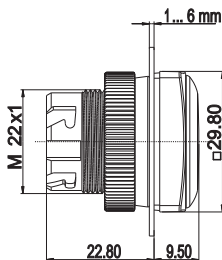

Panel cut-out to IEC 60947-5-1



→ Color of lens	Form of collar	Order no.
transparent red	square	1.74.505.551/1300
transparent yellow	square	1.74.505.551/1400
transparent green	square	1.74.505.551/1500
transparent blue	square	1.74.505.551/1600
transparent colorless	square	1.74.505.551/1000

CONTROL COMPONENTS

RAFIX 22 QR - ACTUATORS AND INDICATORS

– Table (continued) –

RAFIX 22 QR - Signal indicator, flat, square collar, for legend inserts

Accessoires:

Legend insert without legend, use only in combination with transparent lenses.: 5.70.803.000/2000



RAFIX 22 QR Signal indicator, high, square collar

Technical data see page 2 - 131

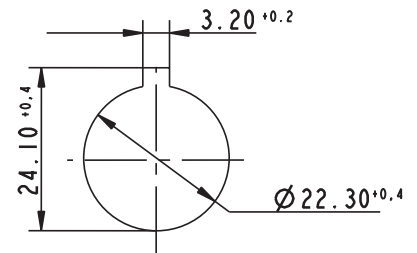
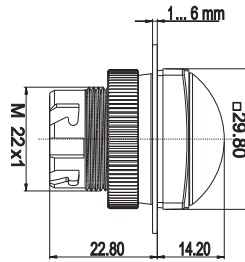

Panel cut-out to IEC 60947-5-1

→ Color of lens	Form of collar	Order no.
transparent red	square	1.74.505.561/1300
transparent yellow	square	1.74.505.561/1400
transparent green	square	1.74.505.561/1500
transparent blue	square	1.74.505.561/1000
transparent blue	square	1.74.505.561/1600

2

RAFIX
22 QR

RAFIX 22 QR Contact blocks with silver contacts

→ Most of the values specified apply to all terminal versions.

Any deviating values specific to the cage clamp or quick-connect version are given in parentheses ().

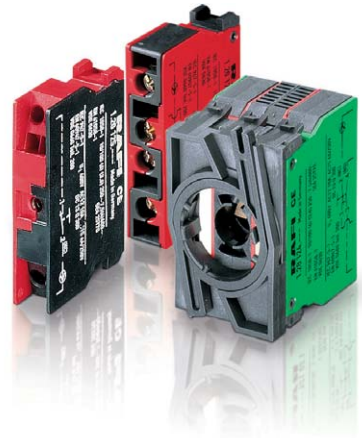

Technical Data

→ Dimensions

Dimensions with coupling	39.5 x 49.9 x 30 mm
Mounting depth without cable	56.4 mm

→ Mechanical design

Mounting	snap on coupling and actuator
Contact system	bridge-contact self cleaning
Contact materials	Ag
Contact arrangement	see order block
Coupling position 1 (1/2)	see order block
Coupling position 3 (5/6), centre	see order block
Coupling position 2 (3/4)	see order block
NC contact forcibly actuated acc. to IEC 60947-5-1	yes
Terminals	see order block
Terminal marking	color encoded
Robustness	100 N
Wire range solid wires without wire end sleeves	2 x 0.75 ... 2.5 mm ²
Wire range stranded wires without end sleeves	2 x 1.0...1.5 (2 x 0.08 ... 2.5) mm ²
Stripping length, solid or stranded	8 mm
Wire range with wire end sleeves	2 x 0.75 ... 1.5 mm ²

→ Electric characteristics acc. to IEC 60947

Rated insulation voltage AC/DC	400 V
Rated peak voltage	6,000 V
Rated operating current I _e AC 12 / DC 12	10 A
Rated operating current I _e AC-15	125 V/10 A, 250 V/6 A, 400 V/3.5 A
Rated operating current I _e DC-13 Q300	24V/2.75A, 60V/1.1A, 125V/0.55A, 250V/0.275A
Degree of pollution	3
Positive opening travel	3 mm
Operating speed	5 ... 1000 mm/c

→ Electric characteristics acc. to IEC 61058

Resistive load AC	10 A / 250 V; 7.5 A / 400 V
Motor load AC	6 A / 250 V; 4 A / 400 V (5 A / 250 V)
Peak input current filament lamp AC	36 A
Peak capacity input current AC	100 A
Protection class	II

→ Other specifications

Operating life at 10 A/250 V AC	70,000 (10A), 200,000 (5A)
Switching reliability at 24V/5mA DC	10 x 10 ⁻⁶
Robustness	acc. to IEC 60947-5-5
Corresponding to CE	acc. EU-guideline NSR 72/73
Shock resistance acc. to IEC 60068-2-27	15 g at 11 ms, amplitude half sinusoidal
Resistance to vibrations acc. to IEC 60068-2-6	5 g at 10 ... 500 Hz
Ambient temp. operating min.	-25 °C
Ambient temp. operating max.	+70°C (+50°C)
Storage temperature min.	-40 °C
Storage temperature max.	+80 °C

Approvals



UL 508, C22.2
No. 14-M91



2004 Steel Vessel
Rules



Rules for the
Classification of
Steel Ships



Marine, offshore
and industrial
use



German Lloyds
type approval
only valid for
version with
screw terminals



IEC 61058 only
for versions with
spring-type
terminal



CONTROL COMPONENTS

RAFIX 22 QR - CONTACT BLOCKS AND INDICATORS

- Technical data (continued) -

RAFIX 22 QR - Contact blocks with silver contacts

Flame class acc. to UL 94	V 0
Hot wire ignition acc. to IEC 60695-2-1	yes
Environmental resistance	acc. to IEC 60068-2-14, -30, -33 and -78
ROHS compliant	yes
REACH compliant	yes

Accessories RAFIX 22 QR - Contact blocks with silver contacts

→ Description	Photo	Order no.	Additional accessories see page
RAFIX 22 QR - Lamp socket BA 9s, without coupling		-	2 - 142
RAFIX 22 QR - LED unit		-	2 - 143
Socket BA 9s (MBC/MCC), LED superbright		-	5 - 8



RAFIX 22 QR Contact block with silver contacts

Technical data see page 2 - 135



Silver contacts, 1 NC, spring-type terminals



Silver contacts, 1 NO, quick connector

→ Contact arrangement	Terminals	Coupling position 1 (1/2)	Coupling position 3 (5/6), centre	Coupling position 2 (3/4)	Order no.
1 NO	screw terminals	-	-	-	5.00.100.140/0000
1 NO	spring type	-	-	-	5.00.100.145/0000
1 NO	solder/quick connector 6.3 x 0.8 mm	-	-	-	5.00.100.196/0000
1 NC	screw terminals	-	-	-	5.00.100.139/0000
1 NC	spring type	-	-	-	5.00.100.144/0000
1 NC	solder/quick connector 6.3 x 0.8 mm	-	-	-	5.00.100.194/0000
2 NO	screw terminals	-	-	-	5.00.100.142/0000
2 NC	screw terminals	-	-	-	5.00.100.141/0000
1 NO, 1 NC	screw terminals	-	-	-	5.00.100.143/0000

– Table (continued) –
RAFIX 22 QR - Contact block with silver contacts

Accessoires:

Coupling: see page 2 - 146

RAFIX 22 QR Contact block assembly, with coupling, silver contacts

Technical data see page 2 - 135

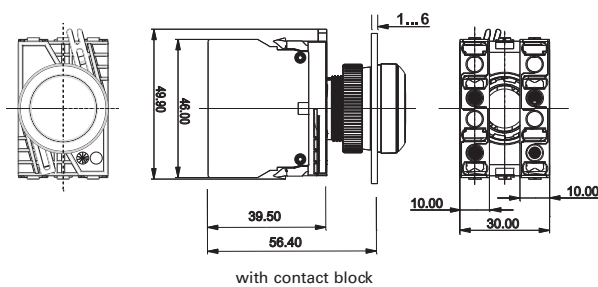

→ Contact arrangement	Terminals	Coupling position 1 (1/2)	Coupling position 3 (5/6), centre	Coupling position 2 (3/4)	Order no.
1 NO	screw terminals	1 NO	-	-	1.20.124.002/0000
1 NO	spring type	1 NO	-	-	1.20.125.002/0000
1 NC	screw terminals	-	-	1 NC	1.20.124.001/0000
1 NC	spring type	-	-	1 NC	1.20.125.001/0000
2 NO	screw terminals	2 NO	-	-	1.20.124.020/0000
1 NO, 1 NO	screw terminals	1 NO	-	1 NO	1.20.124.004/0000
1 NO, 1 NO	spring type	1 NO	-	1 NO	1.20.125.004/0000
2 NC	screw terminals	-	-	2 NC	1.20.124.019/0000
1 NC, 1 NC	screw terminals	1 NC	-	1 NC	1.20.124.003/0000
1 NC, 1 NC	spring type	1 NC	-	1 NC	1.20.125.003/0000
1 NC + 1 NO	screw terminals	1 NC + 1 NO	-	-	1.20.124.017/0000
1 NO, 1 NC	screw terminals	1 NO	-	1 NC	1.20.124.005/0000
1 NO, 1 NC	spring type	1 NO	-	1 NC	1.20.125.005/0000
1 NC + 1 NO, 1 NC + 1 NO	screw terminals	1 NC + 1 NO	-	1 NC + 1 NO	1.20.124.018/0000

Contact arrangement example (1 NO = 1 normally open contact, 1 NC = 1 normally closed contact)

The centre coupling position 3 (5/6) is provided for the LED element resp. the lamp socket element.



RAFIX 22 QR

Contact blocks with gold contacts

→ Most of the values specified apply to all terminal and cage clamp terminal versions. Any deviating values specific to the cage clamp or quick connect version are given in parentheses ().

Technical Data

→ Dimensions

Dimensions with coupling	39.5 x 49.9 x 30 mm
Mounting depth without cable	56.4 mm

→ Mechanical design

Mounting	snap on coupling and actuator
Contact system	bridge-contact self cleaning
Contact materials	Au
Contact arrangement	see order block
Coupling position 1 (1/2)	see order block
Coupling position 3 (5/6), centre	see order block
Coupling position 2 (3/4)	see order block
NC contact forcibly actuated acc. to IEC 60947-5-1	yes
Terminals	see order block
Terminal marking	color encoded
Robustness	100 N
Operating force	-
Wire range solid wires without wire end sleeves	2 x 0.75 ... 2.5 mm ²
Wire range stranded wires without wire end sleeves	2 x 1.0 ... 1.5 mm ²
Stripping length, solid or stranded	8 mm
Wire range with wire end sleeves	2 x 0.75 ... 1.5 mm ²

→ Electrical characteristics

Operating voltage AC/DC	1 ... 35 V
Operating current AC/DC	0.01 ... 100 mA
Rated power max.	1 W (ohmic load)

→ Other specifications

Operating life (operations)	1,000,000 (24 V DC 10 mA)
Switching reliability at 24V/5mA DC	10 x 10 ⁻⁶
Robustness	acc. to IEC 60947-5-5
Corresponding to CE	acc. EU-guideline NSR 72/73
Shock resistance acc. to IEC 60068-2-27	15 g at 11 ms, amplitude half sinusoidal
Resistance to vibrations acc. to IEC 60068-2-6	5 g at 10 ... 500 Hz
Ambient temp. operating min.	-25 °C
Ambient temp. operating max.	+70 °C
Storage temperature min.	-40 °C
Storage temperature max.	+80 °C
Environmental resistance	acc. to IEC 60068-2-14, -30, -33 and -78
ROHS compliant	yes
REACH compliant	yes

CONTROL COMPONENTS

RAFIX 22 QR - CONTACT BLOCKS AND INDICATORS

Accessories RAFIX 22 QR - Contact blocks with gold contacts

→ Description	Photo	Order no.	Additional accessories see page
BA 9s base (MBC/MCC), filament lamps, shape A, DIN 49851		-	5 - 11
RAFIX 22 QR - Lamp socket BA 9s, without coupling		-	2 - 142
RAFIX 22 QR - LED unit		-	2 - 143
Socket BA 9s (MBC/MCC), LED superbright		-	5 - 8

RAFIX 22 QR Contact block with gold contacts

Technical data see page 2 - 138



Gold contacts, 1 NO, spring-type terminals



Gold contacts, 1 NO, quick connector



→ Contact arrangement	Terminals	Coupling position 1 (1/2)	Coupling position 3 (5/6), centre	Coupling position 2 (3/4)	Order no.
1 NO	screw terminals	-	-	-	5.00.100.165/0000
1 NO	spring type	-	-	-	5.00.100.160/0000
1 NO	solder/quick connector 6.3 x 0.8 mm	-	-	-	5.00.100.195/0000
1 NC	screw terminals	-	-	-	5.00.100.164/0000
1 NC	spring type	-	-	-	5.00.100.159/0000
1 NC	solder/quick connector 6.3 x 0.8 mm	-	-	-	5.00.100.193/0000
2 NO	screw terminals	-	-	-	5.00.100.162/0000
2 NC	screw terminals	-	-	-	5.00.100.161/0000
1 NC + 1 NO	screw terminals	-	-	-	5.00.100.163/0000

Accessoires:

Coupling: see page 2 - 146

2

RAFIX
22 QR

CONTROL COMPONENTS

RAFIX 22 QR - CONTACT BLOCKS AND INDICATORS



RAFIX 22 QR Contact block assembly, with coupling, gold contacts

Technical data see page 2 - 138

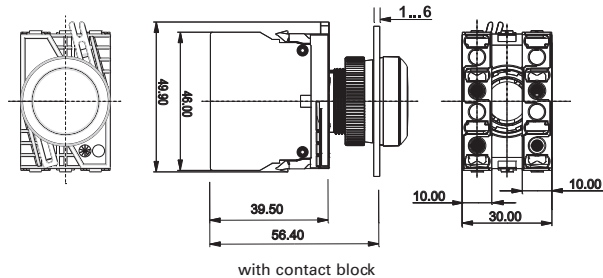

2

RAFIX
22 QR

→ Contact arrangement	Terminals	Coupling position 1 (1/2)	Coupling position 3 (5/6), centre	Coupling position 2 (3/4)	Order no.
1 NO	screw terminals	1 NO	-	-	1.20.124.102/0000
1 NO	spring type	1 NO	-	-	1.20.125.102/0000
1 NC	screw terminals	-	-	1 NC	1.20.124.101/0000
1 NC	spring type	-	-	1 NC	1.20.125.101/0000
2 NO	screw terminals	2 NO	-	-	1.20.124.120/0000
1 NO, 1 NO	screw terminals	1 NO	-	1 NO	1.20.124.104/0000
1 NO, 1 NO	spring type	1 NO	-	1 NO	1.20.125.104/0000
2 NC	screw terminals	-	-	2 NC	1.20.124.119/0000
1 NC, 1 NC	screw terminals	1 NC	-	1 NC	1.20.124.103/0000
1 NC, 1 NC	spring type	1 NC	-	1 NC	1.20.125.103/0000
1 NC + 1 NO	screw terminals	1 NC + 1 NO	-	-	1.20.124.117/0000
1 NO, 1 NC	screw terminals	1 NO	-	1 NC	1.20.124.105/0000
1 NO, 1 NC	spring type	1 NO	-	1 NC	1.20.125.105/0000
1 NC + 1 NO, 1 NC + 1 NO	screw terminals	1 NC + 1 NO	-	1 NC + 1 NO	1.20.124.118/0000

Contact arrangement example (1 NO = 1 normally open contact, 1 NC = 1 normally closed contact)

The centre coupling position 3 (5/6) is provided for the LED element resp. the lamp socket element.

RAFIX 22 QR Lamp sockets BA 9s (MBC/MCC)

Technical Data

→ Dimensions	
Dimensions with coupling	39.5 x 49.9 x 30 mm
Mounting depth without cable	56.4 mm
→ Mechanical design	
Mounting	snap on coupling and actuator
Diode and resistor	see order block
Terminals	see order block
Terminal marking	X1 = anode, X2 = cathode
→ Lamp characteristics	
Lamp socket	BA 9 s
Operating voltage AC/DC	see order block
Lamp power max.	2 W
Lamp voltage	see order block
→ Other specifications	
Approvals	see order block
Robustness	acc. to IEC 60947-5-5
Shock resistance acc. to IEC 60068-2-27	50 g at 11 ms, amplitude half sinusoidal
Resistance to vibrations acc. to IEC 60068-2-6	10 g at 40 ... 500 Hz
Environmental resistance	acc. to IEC 60068-2-14, -30, -33 and -78
Ambient temp. operating max.	+70 °C
Ambient temp. operating min.	-25 °C
Storage temperature min.	-40 °C
Storage temperature max.	+80 °C
Flame class acc. to UL 94	V 0
Hot wire ignition acc. to IEC 60695-2-1	yes
ROHS compliant	yes
REACH compliant	yes

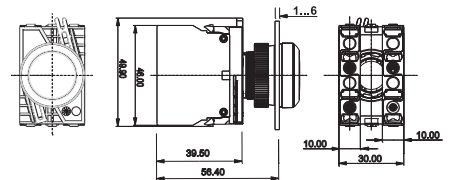

with contact block

Approvals



UL 508, C22.2 No. 14-M91



2004 Steel Vessel Rules



Rules for the Classification of Steel Ships



Marine, offshore and industrial use



Type approval only valid for version with screw terminals



Accessories RAFIX 22 QR - Lamp sockets BA 9s (MBC/MCC)

Description	Photo	Order no.	Additional accessories see page
BA 9s base (MBC/MCC), filament lamps, shape A, DIN 49851		-	5 - 11
Socket BA 9s (MBC/MCC), LED superbright		-	5 - 8

CONTROL COMPONENTS

RAFIX 22 QR - CONTACT BLOCKS AND INDICATORS



RAFIX 22 QR Lamp socket BA 9s, without coupling

Technical data see page 2 - 141

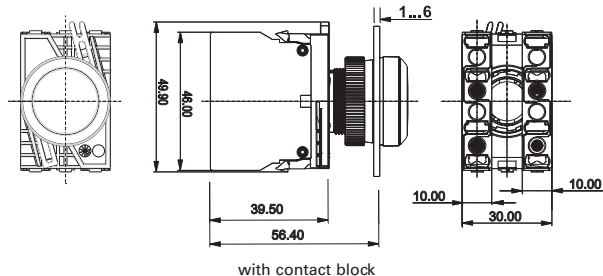

with contact block

→ Terminals	Operating voltage AC/DC	Lamp voltage	Diode and resistor	Order no.
spring type	6 ... 250 V	6 ... 250 V	no	5.00.070.078/0000
solder/quick connector 6.3 x 0.8 mm	6 ... 250 V	6 ... 250 V	no	5.00.070.087/0000
screw terminals	250 V	130 V	yes	5.00.070.080/0000



RAFIX 22 QR Lamp socket BA 9s, assembly with coupling

Technical data see page 2 - 141

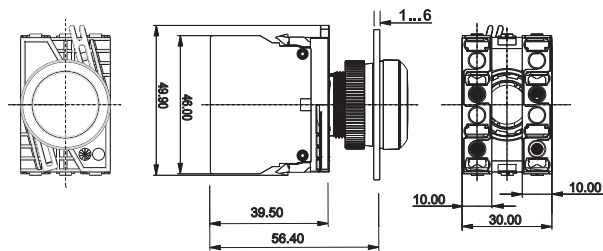

with contact block

→ Terminals	Operating voltage AC/DC	Lamp voltage	Diode and resistor	Order no.
screw terminals	6 ... 250 V	6 ... 250 V	no	1.71.213.001/0000
spring type	6 ... 250 V	6 ... 250 V	no	1.71.214.001/0000
screw terminals	with diode and series resistor 250 V	130 V	yes	1.71.213.004/0000

The lamp socket is mounted in the middle coupling position 3 (5/6).

2

RAFIX
22 QR

RAFIX 22 QR LED units

Technical Data

→ Dimensions	
Dimensions without coupling	46 x 10 x 39.5 mm
Mounting depth without cable	56.4 mm
→ Mechanical design	
Mounting	snap on coupling and actuator
Diode and resistor	see order block
LED color	see order block
Terminals	screw terminals
Terminal marking	X1 = anode, X2 = cathode
→ Lamp characteristics	
Operating voltage	see order block
Max. current, I _F	see order block
→ Other specifications	
Robustness	acc. to IEC 60947-5-1
Shock resistance acc. to IEC 60068-2-27	50 g at 11 ms, amplitude half sinusoidal
Resistance to vibrations acc. to IEC 60068-2-6	10 g at 40 ... 500 Hz
Environmental resistance	acc. to IEC 60068-2-14, -30, -33 and -78
Ambient temp. operating max.	+65 °C
Ambient temp. operating min.	-20 °C
Storage temperature min.	-40 °C
Storage temperature max.	+80 °C
Flame class acc. to UL 94	V 0
Hot wire ignition acc. to IEC 60695-2-1	yes
ROHS compliant	yes
REACH compliant	yes



Approvals



2004 Steel Vessel Rules



Rules for the Classification of Steel Ships



Marine, offshore and industrial use



German Lloyd's type approval

Accessories RAFIX 22 QR - LED unit

Description	Photo	Order no.	Additional accessories see page
Coupling		-	2 - 146

CONTROL COMPONENTS

RAFIX 22 QR - CONTACT BLOCKS AND INDICATORS



RAFIX 22 QR LED unit, without coupling

Technical data see page 2 - 143

2

RAFIX
22 QR

→ LED color	Operating voltage	Max. current, I _F	Terminals	Order no.
red	AC/DC 24 V	15 mA	screw terminals	5.00.070.083/0300
red	AC 115 V	16 mA	screw terminals	5.00.070.085/0300
red	AC 230 V	16 mA	screw terminals	5.00.070.086/0300
yellow	AC/DC 24 V	15 mA	screw terminals	5.00.070.083/0400
yellow	AC 115 V	16 mA	screw terminals	5.00.070.085/0400
yellow	AC 230 V	16 mA	screw terminals	5.00.070.086/0400
green	AC/DC 24 V	15 mA	screw terminals	5.00.070.083/0500
green	AC 115 V	16 mA	screw terminals	5.00.070.085/0500
green	AC 230 V	16 mA	screw terminals	5.00.070.086/0500
blue	AC/DC 24 V	15 mA	screw terminals	5.00.070.083/0600
blue	AC 115 V	16 mA	screw terminals	5.00.070.085/0600
blue	AC 230 V	16 mA	screw terminals	5.00.070.086/0600
white	AC/DC 24 V	15 mA	screw terminals	5.00.070.083/0200
white	AC 115 V	16 mA	screw terminals	5.00.070.085/0200
white	AC 230 V	16 mA	screw terminals	5.00.070.086/0200

CONTROL COMPONENTS

RAFIX 22 QR - SPECIAL ACCESSORIES

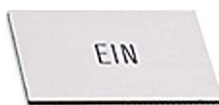

Legend label to clip into label holder 5.07.620.xxx

→ Dimensions	Label	Order no.
28 x 16 x 0,9 mm	-	5.73.110.000/0000
28 x 16 x 0,9 mm	EIN	5.73.110.004/0000
28 x 16 x 0,9 mm	AUS	5.73.110.005/0000
28 x 16 x 0,9 mm	HAND 0 AUTO	5.73.110.021/0000
28 x 16 x 0,9 mm	AUTO HAND	5.73.110.022/0000
28 x 16 x 0,9 mm	HAND 0 AUTO	5.73.110.023/0000
28 x 16 x 0,9 mm	0 I	5.73.110.026/0000
28 x 16 x 0,9 mm	I 0 II	5.73.110.027/0000
28 x 16 x 0,9 mm	EIN AUS	5.73.110.028/0000
28 x 16 x 0,9 mm	AUS EIN	5.73.110.029/0000

Legending available on request.

Coupling

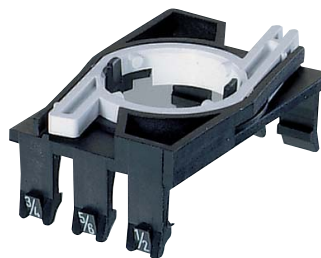

→ Description	Order no.
Coupling with reference numbers 1-3-2, for contact blocks with single contacts	5.05.510.935/0000
Coupling with reference numbers 1/2-5/6-3/4, for contact blocks with double contacts	5.05.510.936/0000

RAFIX 22 QR Blanking cap, Ø 22.3 mm



round blanking cap

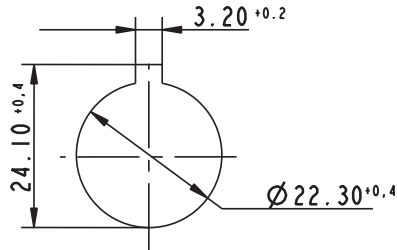

Panel cut-out to IEC 60947-5-1



→ Description	Order no.
Blanking cap IP65, ring nut, square, slate grey	5.05.800.065/0000
Blanking cap IP65, ring nut, round, slate grey	5.05.800.064/0000

Protection acc. to DIN EN 60529

Protective cover, suitable for pushbuttons with flush lens



Protective cover, mounted



→ Description	Order no.
Protective cover, latching	5.05.511.195/0000
Protective cover, auto-closing	5.05.511.194/0000

CONTROL COMPONENTS

RAFIX 22 QR - SPECIAL ACCESSORIES



RAFIX Insulating housing IP65, Ø 22.3 mm

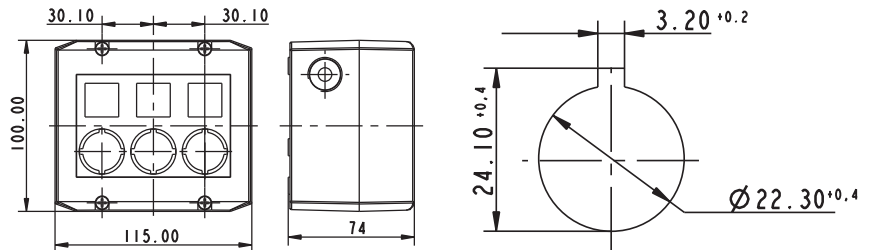

Panel cut-out to IEC 60947-5-1

→ Description	Number of cut-outs	Ø	Dimensions	Order no.
RAFIX - Insulating housing, Ø 22.3 mm, IP65, 1-module, light grey/dark grey	1	22,3 mm	100x55x74 mm	1.20.810.201/0000
RAFIX - Insulating housing, Ø 22.3 mm, IP65, 1-module, yellow/yellow	1	22,3 mm	100x55x74 mm	1.20.810.202/0000
RAFIX - Insulating housing, Ø 22.3 mm, IP65, 2-module, light grey/dark grey	2	22,3 mm	100x115x74 mm	1.20.820.201/0000
RAFIX - Insulating housing, Ø 22.3 mm, IP65, 3-module, light grey/dark grey	3	22,3 mm	100x115x74 mm	1.20.830.201/0000
RAFIX - Insulating housing, Ø 22.3 mm, IP65, 4-module, light grey/dark grey	4	22,3 mm	100x145x74 mm	1.20.840.201/0000

- Plastic housing to accommodate up to 4 control components
- 2 cable entries prepared: 1-,2-,3-part: M20x1.5, 4-part: M25x1.5
- Degree of protection IP65 to DIN EN 60529

- All grey housings with overlay, legending possible with legend inserts
- Wall mounting with 2 screws through housing bottom prepared
- Dimensions: (feature 2) x 100 mm x 74 mm
- Accessories: 50 pre-perforated legend inserts on a DIN A4 sheet

Accessoires:

Label sheet for housing (50 foil legend inserts): 5.40.451.283/0000

2

RAFIX
22 QR

Emergency stop label, Ø 22.3 mm

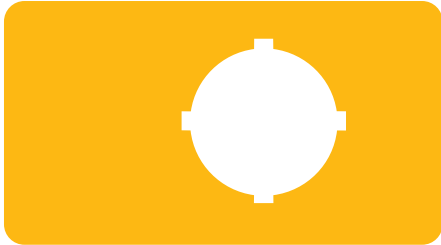

→ Dimensions	inside Ø	Label	Order no.
36 x 64 mm	22.3 mm	-	5.76.205.011/0400
Ø 40 mm	22.3 mm	„NOT-HALT, EMERGENCY STOP, ARRET D'URGENCE, EMERGENZA“	5.76.204.115/0400
Ø 40 mm	22.3 mm	4 x „NOT-HALT“	5.76.204.117/0400
Ø 40 mm	22.3 mm	4 x „NOT-AUS“	5.76.204.119/0400
Ø 40 mm	22.3 mm	4 x „EMERGENCY STOP“	5.76.204.121/0400
Ø 60 mm	22.3 mm	1 x „NOT-AUS“	5.76.207.001/0400
Ø 60 mm	22.3 mm	„EMERGENCY-STOP / ARRET D'URGENCE“	5.76.207.002/0400
Ø 60 mm	22.3 mm	1 x „NOT-AUS“	5.76.204.101/0400
Ø 60 mm	22.3 mm	1 x „ARRET D'URGENCE“	5.76.204.102/0400
Ø 60 mm	22.3 mm	1 x „EMERGENCY STOP“	5.76.204.103/0400
Ø 60 mm	22.3 mm	„NOT-HALT, EMERGENCY STOP, ARRET D'URGENCE, EMERGENZA“	5.76.204.107/0400
Ø 60 mm	22.3 mm	4 x „NOT-HALT“	5.76.204.109/0400
Ø 60 mm	22.3 mm	4 x „NOT-AUS“	5.76.204.111/0400
Ø 60 mm	22.3 mm	4 x „EMERGENCY STOP“	5.76.204.113/0400

CONTROL COMPONENTS

RAFIX 22 QR - SPECIAL ACCESSORIES



RAFIX 22 QR / RAFIX 22 FSR Protective collar

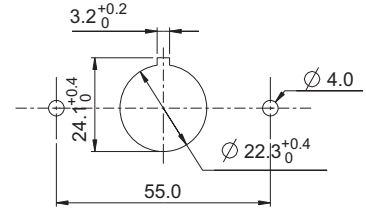
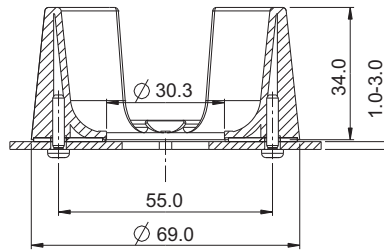

2

Description	Order no.
Protective Collar for emergency stop RAFIX 22 QR	5.00.456.002/0000

RAFI protective collars protect the pushbuttons from unintentional operation and damage. Another great advantage is that they can be mounted directly on the front panel using two screws and without mechanical attachment to the actuator and/or emergency stop pushbutton. This provides for additional safety because lateral forces are not transferred to the actuator housing.

RAFIX
22 QR

CONTROL COMPONENTS

RAFIX FS Technology

2

RAFIX 22 FS⁺	2 - 151
RAFIX 22 FS ⁺ - Pushbuttons	2 - 159
- NEW - RAFIX 22 FS ⁺ - Pushbuttons FLEXLAB	2 - 166
RAFIX 22 FS ⁺ - Pushbuttons with protective cap	2 - 170
RAFIX 22 FS ⁺ - Selector switches	2 - 173
RAFIX 22 FS ⁺ - Keylock switches	2 - 176
- NEW - RAFIX 22 FS ⁺ - Keylock switches compact	2 - 179
RAFIX 22 FS ⁺ - Mushroom-headed pushbuttons	2 - 182
RAFIX 22 FS ⁺ - Emergency stop pushbuttons	2 - 184
- NEW - RAFIX 22 FS ⁺ - Emergency stop pushbuttons compact	2 - 187
RAFIX 22 FS ⁺ - Emergency stop pushbuttons „Plus 1“	2 - 189
RAFIX 22 FS ⁺ - Potentiometer drives	2 - 192
RAFIX 22 FS ⁺ - Signal indicators	2 - 194
RAFIX 22 FS ⁺ - USB feedthroughs	2 - 198
RAFIX 22 FSR	2 - 201
- NEW - RAFIX 22 FSR - Pushbuttons	2 - 206
- NEW - RAFIX 22 FSR - Selector switches	2 - 208
- NEW - RAFIX 22 FSR - Keylock switches	2 - 210
- NEW - RAFIX 22 FSR - Emergency stop pushbuttons	2 - 212
- NEW - RAFIX 22 FSR - Signal indicators	2 - 215
RAFIX 30 FS⁺	2 - 217
- NEW - RAFIX 30 FS ⁺ - Pushbuttons	2 - 221
- NEW - RAFIX 30 FS ⁺ - Pushbuttons FLEXLAB	2 - 223
- NEW - RAFIX 30 FS ⁺ - Selector switches	2 - 226
- NEW - RAFIX 30 FS ⁺ - Keylock switches	2 - 228
- NEW - RAFIX 30 FS ⁺ - Lenses	2 - 230
- NEW - RAFIX 30 FS ⁺ - USB feedthroughs	2 - 232
RAFIX FS Technology - Contact blocks	2 - 235
RAFIX FS - Contact blocks PCB gold	2 - 241
RAFIX FS - Contact blocks PCB silver	2 - 246
RAFIX FS - Contact blocks QC gold	2 - 252
RAFIX FS - Contact blocks QC silver	2 - 255
- NEW - RAFIX FS - Short-travel adapters	2 - 258
RAFIX FS Technology - Special accessories	2 - 259
RAFIX FS Technology - Special accessories	2 - 261



RAFIX 22 FS⁺

RAFIX 22 FS⁺ control component range

- Mounting hole diameter: 22.3 mm to IEC 60947
- Contact blocks with gold or silver contacts
- Depth behind panel only 9.2 resp. 27 mm
- Protection class min. IP65 acc. to DIN EN 60529
- 2 collar shapes, round or square
- The PCB contact blocks can be combined with other components on the same PCB.
- Contact blocks with quick connectors and LED clips
- All products are RoHS compliant.

The specified data apply only if actuators and signal indicators are combined with contact blocks or LED within the same product range.

CONTROL COMPONENTS

RAFIX 22 FS⁺

Content

RAFIX 22 FS⁺ Pushbuttons	2 - 159
RAFIX 22 FS ⁺ Pushbutton, flush lens, round collar	2 - 160
RAFIX 22 FS ⁺ Pushbutton, protruding lens, round collar	2 - 161
RAFIX 22 FS ⁺ Pushbutton, protruding front ring, round collar	2 - 162
RAFIX 22 FS ⁺ Pushbutton, flush lens, square collar	2 - 163
RAFIX 22 FS ⁺ Pushbutton, protruding lens, square collar	2 - 164
RAFIX 22 FS ⁺ Pushbutton, protruding front ring, square collar	2 - 165
RAFIX 22 FS⁺ Pushbuttons FLEXLAB	2 - 166
RAFIX 22 FS ⁺ Pushbutton FLEXLAB, round collar	2 - 168
RAFIX 22 FS ⁺ Pushbutton FLEXLAB, square collar	2 - 168
RAFIX 22 FS⁺ Pushbuttons with protective cap	2 - 170
RAFIX 22 FS ⁺ Pushbutton, with protective cap, flush lens, round collar	2 - 171
RAFIX 22 FS ⁺ Pushbutton, with protective cap, flush lens, square collar	2 - 172
RAFIX 22 FS⁺ Selector switches	2 - 173
RAFIX 22 FS ⁺ Selector switch, round collar	2 - 174
RAFIX 22 FS ⁺ Selector switch, square collar	2 - 175
RAFIX 22 FS⁺ Keylock switches	2 - 176
RAFIX 22 FS ⁺ Keylock switch, round collar	2 - 177
RAFIX 22 FS ⁺ Keylock switch, square collar	2 - 178
RAFIX 22 FS⁺ Keylock switches compact	2 - 179
RAFIX 22 FS ⁺ Keylock switch compact, round collar	2 - 180
RAFIX 22 FS ⁺ Keylock switch compact, square collar	2 - 181
RAFIX 22 FS⁺ Mushroom-headed pushbuttons	2 - 182
RAFIX 22 FS ⁺ Mushroom-headed pushbutton	2 - 183
RAFIX 22 FS⁺ Emergency stop pushbuttons	2 - 184
RAFIX 22 FS ⁺ Emergency stop pushbutton, reset by rotation	2 - 185
RAFIX 22 FS ⁺ Emergency stop pushbutton, reset by pulling (IP65, IP69K)	2 - 186
RAFIX 22 FS⁺ Emergency stop pushbuttons compact	2 - 187
RAFIX 22 FS ⁺ Emergency stop pushbutton compact, reset by rotation	2 - 188
RAFIX 22 FS⁺ Emergency stop pushbuttons „Plus 1“	2 - 189
RAFIX 22 FS ⁺ Emergency stop pushbutton „Plus 1“, reset by rotation	2 - 190
RAFIX 22 FS ⁺ Emergency stop pushbutton „Plus 1“, reset by pulling (IP65, IP69K)	2 - 191
RAFIX 22 FS⁺ Potentiometer drives	2 - 192
RAFIX 22 FS ⁺ Potentiometer drive, round collar	2 - 193
RAFIX 22 FS ⁺ Potentiometer drive, square collar	2 - 193
RAFIX 22 FS⁺ Signal indicators	2 - 194
RAFIX 22 FS ⁺ Signal indicator, round collar, flat version	2 - 195
RAFIX 22 FS ⁺ Signal indicator, round collar, high version	2 - 195
RAFIX 22 FS ⁺ Signal indicator, square collar, flat version	2 - 196
RAFIX 22 FS ⁺ Signal indicator, square collar, high version	2 - 196
RAFIX 22 FS⁺ USB feedthroughs	2 - 198
RAFIX 22 FS ⁺ USB feedthrough, round collar	2 - 199
RAFIX 22 FS ⁺ USB feedthrough, square collar	2 - 199

2

RAFIX
22 FS⁺

RAFIX 22 FS⁺

Control components of the future

The RAFIX 22 FS⁺ series is setting new standards in the world of control components. Extremely flat construction and functional aesthetic design are essential in an increasingly design-oriented industrial environment. The wide variety and variability of the actuators give your designer complete freedom: round or square collar types, radiant colours and homogenous illumination of the large actuat-

ing areas are among the basic features. Combined with the various front rings, they ensure that you can create a panel with a truly distinctive design. For example, a defined colour can be consistently assigned to a specific command. In addition, the large number of colour options available for the front rings enables easy customisation to suit the corporate design of different OEMs.



2

RAFIX
22 FS⁺

Fast

The fastest connection type for every application: with a printed circuit board or directly with quick-connect terminals.

- A printed circuit board is the best and fastest solution, starting with medium quantities. Moreover, PCB contact blocks can be ideally combined with displays, tactile switches and other electronics on a common printed circuit board.
- Alternatively, QC contact blocks can be easily snapped into the actuators without tools. Male quick-connect terminals are used directly for wiring in a conventional manner. This is a fast and efficient variant for applications where a printed circuit board is not cost-effective.

+ PLUS

RAFIX 22 FS⁺ has additional benefits for you:

- Various actuators and contact block options – a complete series
- Variable thanks to round or square operating elements
- Variable thanks to gold contacts from 5 V or silver contacts up to 250 V
- Short-travel adapter for short-travel actuation (1 mm switching travel) with perceptible key click
- Variable design thanks to various front ring colours
- Variable illumination, compatible with 3 mm THT LEDs or SMT LEDs

SLIM

Now it's a snap to slim the design of your control systems thanks to the low mounting depth.

- Designs with PCB contact blocks feature a distance between the front panel and printed circuit board of only 9.2 mm; the same applies to contact blocks with silver contacts for the mains voltage. That's as slim as it gets.
- Also when fitted with QC contact blocks, RAFIX 22 FS⁺ panels are unbeatably flat. Requiring only 27 mm of space behind the front panel, they provide tremendous design scope for inspiring control panels.



CONTROL COMPONENTS

RAFIX 22 FS⁺ CONTROL COMPONENTS

RAFIX 22 FS⁺

The RAFIX 22 FS⁺ series has a variety of actuators with round or square collar types:



Pushbuttons

- Illuminable
- With flush or protruding lens
- With flush or protruding front ring
- With protective cap
- With exchangeable FLEXLAB lens
- With illuminated front ring (optional)

Selector switches

- Rotating angle 40°, 60° or 90°
- Latching or momentary
- Illuminable

Keylock switches

- Rotating angle 40° or 90°
- Latching or momentary

Signal indicators

- Green, yellow, red, blue or white

Approvals

- IEC 60947-5-1/5
- UL
- CCC

Safe and reliable

The actuators in the RAFIX 22 FS⁺ series consistently ensure a degree of protection to at least IP 65, which makes them suitable for many diverse applications.

Durable

The mechanical design of all actuators is optimally suited for long-lasting operation even in heavily used panels.

Mounting hole

The actuators in the RAFIX 22 FS⁺ series are suitable for 22.3 mm panel cut-outs according to IEC 60947-5-1.

All actuators are equipped with a locating pip. This locating pip ensures a perfect fit for actuators and contact blocks with PCB-mounted components and is therefore essential for designs including these contact blocks.

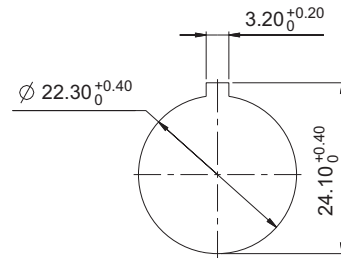

Grid spacing

The design principle makes it possible to use a minimum grid spacing of 30 mm x 30 mm. In such an arrangement, actuators with square collars can be aligned directly without any gaps.

When choosing the grid spacing, it is recommended to consider any external legending required (for example, using label strips inserted into the front panel).

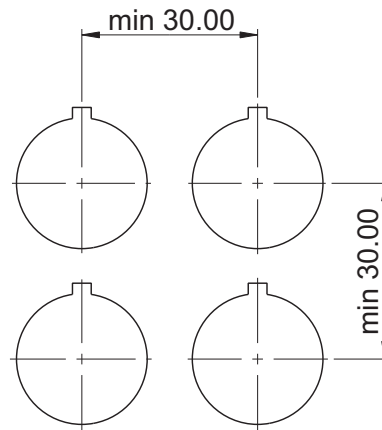

RAFIX 22 FS⁺ PCB

PCB contact blocks



2

Dimensional drawing with PCB contact block

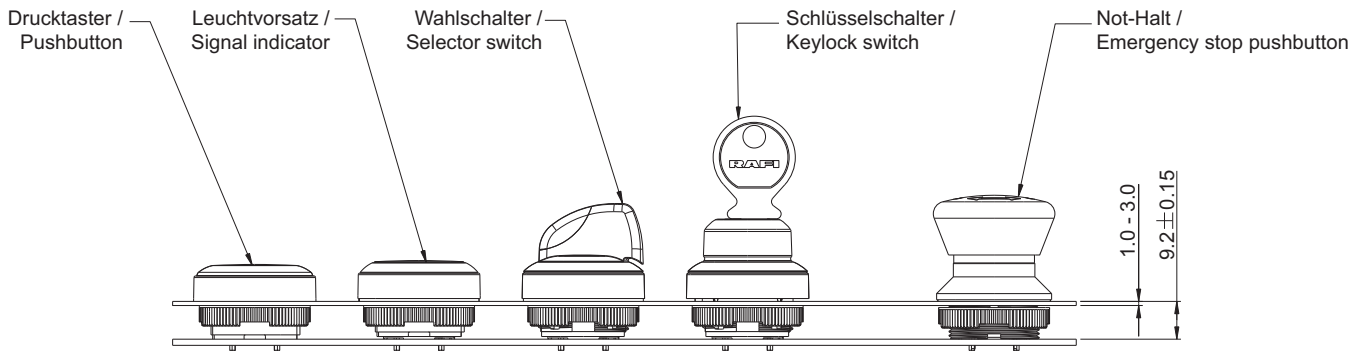

<p>Formula for spacer length</p> $\frac{9.2 \text{ mm} - \text{Front panel thickness}}{\text{Length of spacer}}$
--

RAFIX 22 FS⁺

PCB contact blocks

A printed circuit board is the best and fastest solution, starting with medium quantities. In addition, PCB contact blocks can be ideally combined with displays, short-travel keyswitches and other electronics on a common printed circuit board. Designs with PCB contact blocks feature a distance between the front panel and printed circuit board of only 9.2 mm; the same applies to contact blocks with silver contacts for the mains voltage. The printed circuit board is attached to the front panel with bolts, while the contact blocks are almost fully immersed in the actuators. This gives the entire system a very low profile. Further benefits: individual wiring is not required, and it is no longer necessary to cut out the printed circuit board around the control components.

FAST: Simply include the PCB contact blocks and LEDs in the layout of the printed circuit board and solder them during production – done as simply as with the other components on the common printed circuit board.

Assembly: Cost savings and reduction of assembly errors. The PCB contact blocks are soldered on the printed circuit board. Two options are available for actuator illumination:

1. A 3 mm THT LED that is inserted into the base of the contact block and soldered together with the contact block on the printed circuit board.
2. A separately placed SMT LED that produces light which is transported by the light conductor and distributed over the entire surface of the lens.

SLIM – enabling lean operation

Designs with PCB contact blocks feature a distance between the front panel and printed circuit board of only 9.2 mm; the same applies to contact blocks with silver contacts for the mains voltage. That's as slim as it gets.

RAFIX 22 FS⁺ PCB

Putting it all together

As part of the system design, the printed circuit board is attached to the front panel using threaded studs. This one-off construction measure ensures that no assembly errors can occur that would require subsequent troubleshooting. Very cost-effective for large quantities.

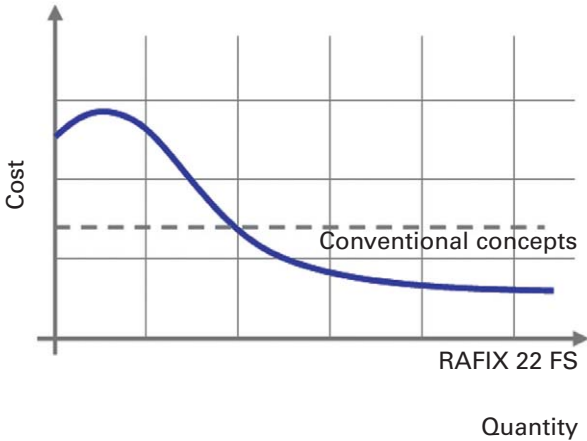

2

RAFIX 22 FS⁺

Spacers

A distance of 9.2 mm behind the front panel must be maintained. See the RAFI accessories for the necessary spacers.

Formula for spacer length

RAFIX 22 FS⁺ and RAFIX 22 FSR

9.2 mm

- Front panel thickness

Length of spacers

Benefits

- The extremely low mounting depth is unique and enables applications with entirely new housing and machine designs
- The series can be combined with RAFI short-travel keyswitches to tailor the operation to particular customer applications
- Standardised production with printed circuit boards pays off for large quantities and cuts assembly costs

Optimal applications meet the following conditions

- Usage of a printed circuit board is already planned. Printed circuit boards pay off for large quantities since production can be standardised.
- Short-travel keyswitches are used. RAFIX FS PCB contact blocks can be combined, for example, with RAFI short-travel keyswitches from the series MICON 5, RACON 8/12, RF 15/19 and KN 19.
- Tight space requirements: RAFIX FS technology can be used to realise smaller housing formats. This leads to savings on materials as well as tool costs.

Key points at a glance

- Mounting depth only 9.2 mm
- PCB contact blocks with printed circuit board THT terminal
- Gold contacts for totally reliable switching at low voltages (min. 5 V / 1 mA) or
- Silver contacts (max. 250 V / 4 A) for mains voltage
- Contact assignments: 1 NC, 1 NO, 2 NC, 2 NO, 1 NC + 1 NO, or for safety-relevant applications 2 NC + 1 NO (emergency stop "Plus 1")
- Illumination with LEDs in various colours
- Compatible with all RAFIX 22 FS⁺, RAFIX 22 FSR and RAFIX FS 30 actuators such as pushbuttons, selector switches, keylock switches, emergency stop buttons and signal indicators with all the benefits of this series



Combination of RAFIX 22 FS⁺ with RAFI short-travel keyswitches on a common printed circuit board



Top half: RAFI short-travel keyswitches RACON 8/12, MICON 5, RF 15/19, short-travel mains switch KN 19
Bottom half: RAFIX FS contact blocks, some with 3 mm THT LEDs

RAFIX 22 FS⁺ QC

The system

For the actuators in the RAFIX 22 FS⁺, RAFIX 22 FSR and RAFIX 30 FS⁺ series, RAFI offers QC contact blocks with plug-in connection. All it takes is a “click” to latch the contact block into the fixed actuator for a solid connection.



The concept

In cases where usage of a printed circuit board is not feasible or cost-effective, QC contact blocks provide an economical alternative. Locating lugs on the contact block latch into the actuators with precision in the millimetres. Matching guides are arranged in the thread to ensure a solid connection. Wiring the contact block is easy due to the standard male quick-connect terminals. As an isolation aid, there is a middle fin which is also used as a guide for the optional LED clip.

The QC contact block rounds out the RAFIX 22 FS⁺, RAFIX 22 FSR and RAFIX 30 FS⁺ series, making them suitable for all customer requirements. Separately installed control devices can be **easily** integrated into the system **without any tools**, helping users to save space, work expense and materials.

Assembly

The colour marking on the actuator thread and contact block helps to prevent incorrect assembly, thereby simplifying the assembly process. Briefly press the contact block and it will securely latch into the actuator (“click to install”).

Benefits

- Very fast and simple attachment of QC contact blocks saves valuable assembly time.
- The fixed connection between the contact block and actuator is suitable for applications with tremors and vibrations.
- Cable harnesses can be preassembled with the contact blocks.

Optimal applications meet the following conditions

- Usage of a printed circuit board is not cost-effective, for example away from main control points (e.g. emergency stop application in a hazard area).
- Typical control components need to be installed quickly. The installation time is significantly shorter for RAFIX QC contact blocks than for other available control component concepts.
- Significant vibrations and tremors are present. All parts are solidly connected.
- Other components need an appropriate amount of space.

RAFIX FS QC: Key points at a glance

- Mounting depth only 27 mm including LED clip and cable lugs
- QC contact blocks with quick-connect/solder terminals 2.8 x 0.8 mm
- The QC contact block engages permanently with the actuator only at the time of final assembly
- Compatible with all RAFIX 22 FS⁺, RAFIX 22 FSR and RAFIX 30 FS⁺ actuators such as pushbuttons, selector switches, keylock switches, emergency stop buttons and signal indicators with all the benefits of this series
- Protection against contact for quick-connect terminals and cable lugs: short-circuit-proof even when the connection wires are under tensile strain
- Gold contacts for totally reliable switching at low voltages (min. 5 V / 1 mA) or
- Silver contacts (max. 250 V / 4 A) for mains voltage
- Contact assignments: 1 NC, 1 NO, 2 NC, 2 NO, 1 NC + 1 NO, or for safety-relevant applications 2 NC + 1 NO (emergency stop “Plus 1”)
- Illumination with replaceable and extremely bright LED clips in various LED colours, with quick-connect terminals 2.8 x 0.8 mm
- Actuators / contact blocks, signal indicators / lamp sockets and LED clips can be stocked separately and are not connected until final assembly. In this manner, the product range ensures maximum flexibility along with economical inventory management.

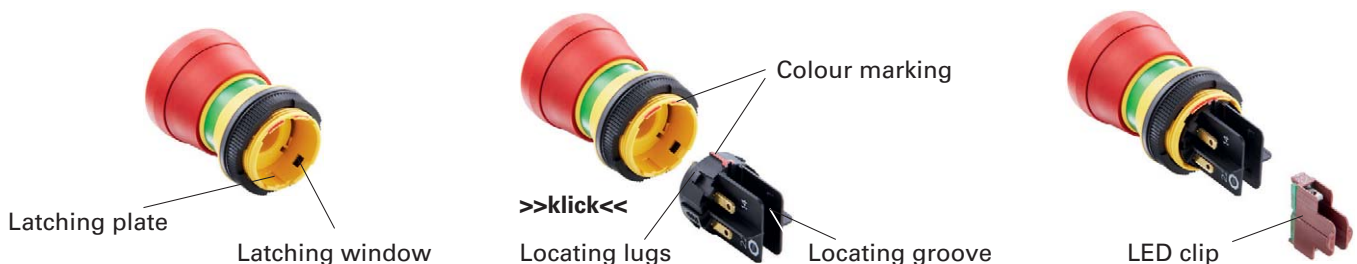

CONTROL COMPONENTS

RAFIX 22 FS⁺ CONTROL COMPONENTS

RAFIX 22 FS⁺ QC

Dimensional drawing with QC contact block

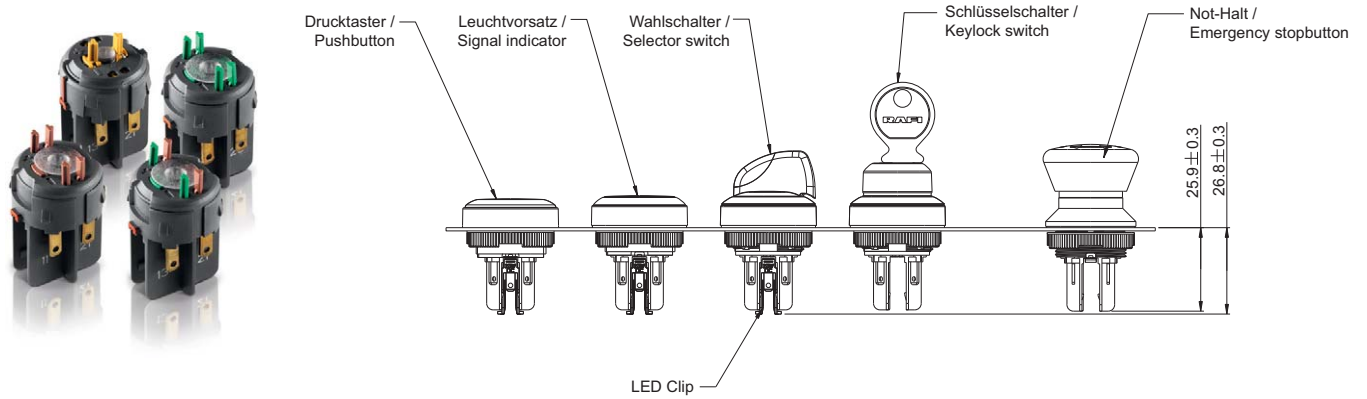

Terminal diagram (view from below)

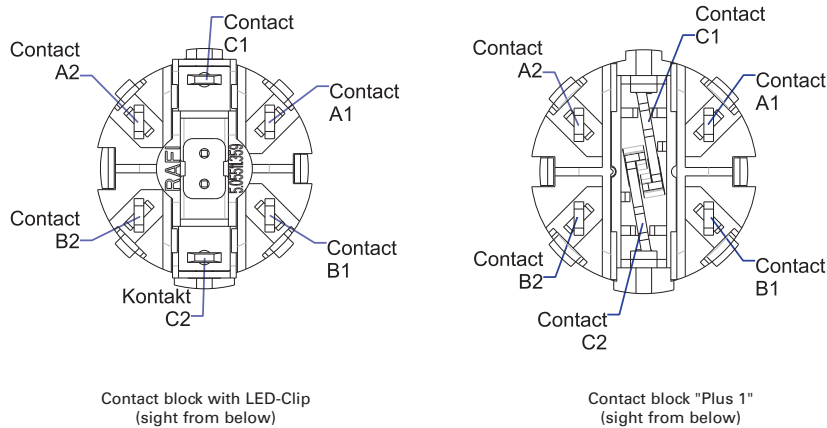

Contact arrangement	1NO	1NC	2NO	2NC	1NC + 1NO	Plus 1
Contact A1/A2	1NO	-	1NO	1NC	1NO	1NC
Terminal legending	13 - 14		13 - 14	11 - 12	13 - 14	11 - 12
Contact B1/B2	-	1NC	1NO	1NC	1NC	1NC
Terminal legending		21 - 22	23 - 24	21 - 22	21 - 22	21 - 22
Contact C1/C2	LED*	LED*	LED*	LED*	LED*	1NO
Terminal legending	X1 - X2	X1 - X2	X1 - X2	X1 - X2	X1 - X2	33 - 34

Contact diagram for selector and keylock switches

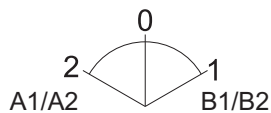

All actuators with 3 switch positions

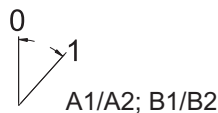

All actuators with 2 switch positions

RAFIX 22 FS⁺ Pushbuttons

Technical Data

→ General information

Form of lens	see order block
Color of lens	see order block
Color of front ring	see order block
Form of collar	see order block

→ Dimensions

Dimensions of collar	see order block
Overall height	see order block
Mounting depth	PCB 9.2 mm, QC 27 mm
Mounting hole	22.3 mm
Key grid	30 x 30 mm

→ Mechanical design

Mounting	ring nut
Contact function	see order block
Illuminability	see order block
Torque for nut ring	1.2 Nm

→ Mechanical characteristics

Operating travel	4 mm
Robustness max.	100 N

→ Other specifications

Ambient temp. operating min.	-25 °C
Ambient temp. operating max.	+70 °C
Storage temperature min.	-40 °C
Storage temperature max.	+80 °C
Operating life	1,000,000 momentary / 500,000 latching
B10	1,300,000 momentary / 650,000 latching
Degree of protection from front side	IP65 (DIN EN 60529)
Environmental resistance	acc. to IEC 60068-2-14, -30, -33 and -78
Salt spray	IEC 600 68-2-11
ROHS compliant	yes
REACH compliant	yes

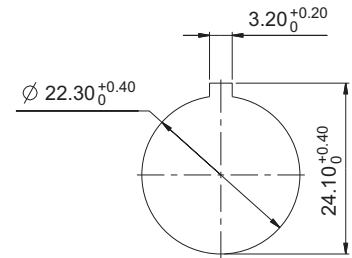

Panel cut-out to IEC 60947-5-1

Approvals



IEC 60947-5-x



UL 508



2

RAFIX
22 FS⁺

Accessories RAFIX 22 FS⁺ - Pushbuttons

Description	Photo	Order no.	Additional accessories see page
RAFIX 22 FS ⁺ - Contact block PCB silver, Universal, with light conductor		-	2 - 247
RAFIX 22 FS ⁺ - Contact block QC gold, Universal, with light conductor		-	2 - 253
RAFIX 22 FS ⁺ - Contact block QC silver, Universal, with light conductor		-	2 - 256
RAFIX FS - Contact block PCB gold, Universal		-	2 - 243
RAFIX FS - Contact block PCB gold, Universal, with light conductor		-	2 - 242
RAFIX FS - Contact block PCB silver, Universal		-	2 - 248
Fixing spanner for ring nut		5.05.800.062/0000	2 - 145, 2 - 261, 5 - 25

CONTROL COMPONENTS

RAFIX 22 FS⁺ - ACTUATORS



RAFIX 22 FS⁺ Pushbutton, flush lens, round collar

Technical data see page 2 - 159

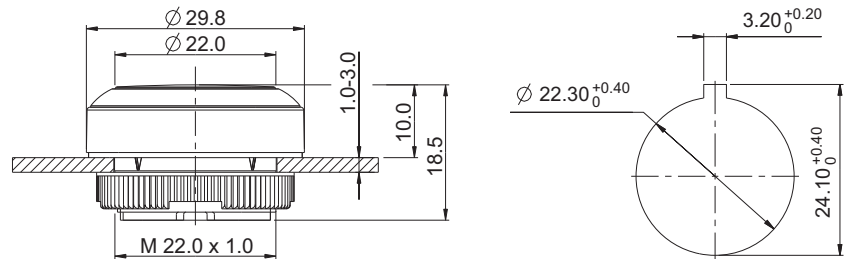

Panel cut-out to IEC 60947-5-1

→ Illuminability	Color of lens	Order no. momentary		Order no. latching	
		Plastic front ring	Metallized front ring	Plastic front ring	Metallized front ring
yes	translucent red	1.30.270.001/23xx	1.30.270.021/2300	1.30.270.011/23xx	1.30.270.031/2300
yes	translucent yellow	1.30.270.001/24xx	1.30.270.021/2400	1.30.270.011/24xx	1.30.270.031/2400
yes	translucent green	1.30.270.001/25xx	1.30.270.021/2500	1.30.270.011/25xx	1.30.270.031/2500
yes	translucent blue	1.30.270.001/26xx	1.30.270.021/2600	1.30.270.011/26xx	1.30.270.031/2600
yes	translucent white	1.30.270.001/22xx	1.30.270.021/2200	1.30.270.011/22xx	1.30.270.031/2200
no	opaque slate-grey	1.30.270.001/07xx	1.30.270.021/0700	1.30.270.011/07xx	1.30.270.031/0700
no	opaque black	1.30.270.001/01xx	1.30.270.021/0100	1.30.270.011/01xx	1.30.270.031/0100

xx = Front ring color: black = 01, red = 03, yellow = 04, green = 05, blue = 06, slate grey = 07, silver grey = 08

Legending on request.

2

RAFIX
22 FS⁺

RAFIX 22 FS⁺ Pushbutton, protruding lens, round collar

Technical data see page 2 - 159

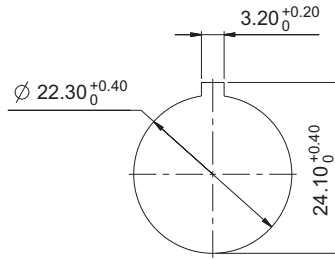
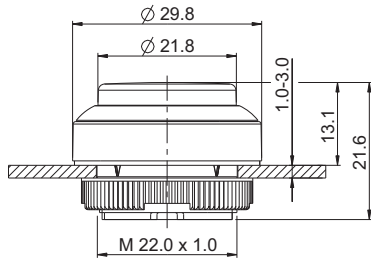

Panel cut-out to IEC 60947-5-1



2

→ Illuminability	Color of lens	Order no. momentary		Order no. latching	
		Plastic front ring	Metallized front ring	Plastic front ring	Metallized front ring
yes	translucent red	1.30.270.201/23xx	1.30.270.221/2300	1.30.270.211/23xx	1.30.270.231/2300
yes	translucent yellow	1.30.270.201/24xx	1.30.270.221/2400	1.30.270.211/24xx	1.30.270.231/2400
yes	translucent green	1.30.270.201/25xx	1.30.270.221/2500	1.30.270.211/25xx	1.30.270.231/2500
yes	translucent blue	1.30.270.201/26xx	1.30.270.221/2600	1.30.270.211/26xx	1.30.270.231/2600
yes	translucent white	1.30.270.201/22xx	1.30.270.221/2200	1.30.270.211/22xx	1.30.270.231/2200
no	opaque slate-grey	1.30.270.201/07xx	1.30.270.221/0700	1.30.270.211/07xx	1.30.270.231/0700
no	opaque black	1.30.270.201/01xx	1.30.270.221/0100	1.30.270.211/01xx	1.30.270.231/0100

RAFIX
22 FS⁺

xx = Front ring color: black = 01, red = 03, yellow = 04, green = 05, blue = 06, slate grey = 07, silver grey = 08

Legending on request.

CONTROL COMPONENTS

RAFIX 22 FS⁺ - ACTUATORS



RAFIX 22 FS⁺ Pushbutton, protruding front ring, round collar

Technical data see page 2 - 159

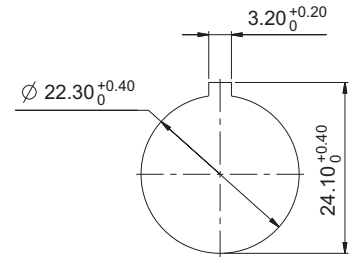
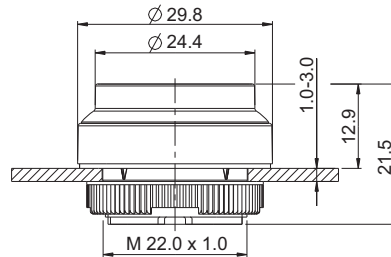

Panel cut-out to IEC 60947-5-1

→ Illuminability	Color of lens	Order no. momentary		Order no. latching	
		Plastic front ring	Metallized front ring	Plastic front ring	Metallized front ring
yes	translucent red	1.30.270.401/23xx	1.30.270.421/2300	-	-
yes	translucent yellow	1.30.270.401/24xx	1.30.270.421/2400	-	-
yes	translucent green	1.30.270.401/25xx	1.30.270.421/2500	-	-
yes	translucent blue	1.30.270.401/26xx	1.30.270.421/2600	-	-
yes	translucent white	1.30.270.401/22xx	1.30.270.421/2200	-	-
no	opaque slate-grey	1.30.270.401/07xx	1.30.270.421/0700	-	-
no	opaque black	1.30.270.401/01xx	1.30.270.421/0100	-	-

xx = Front ring color: black = 01, red = 03, yellow = 04, green = 05, blue = 06, slate grey = 07, silver grey = 08

Legending on request.

2

RAFIX
22 FS⁺

RAFIX 22 FS⁺ Pushbutton, flush lens, square collar

Technical data see page 2 - 159

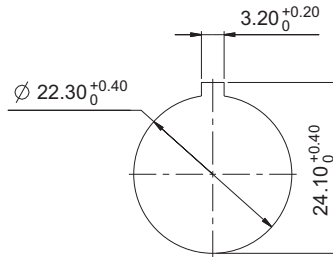
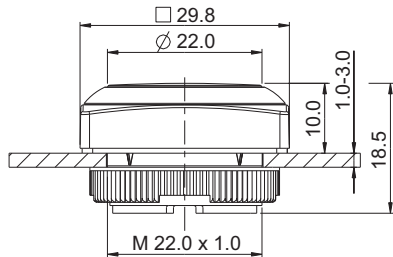

Panel cut-out to IEC 60947-5-1



2

→ Illuminability	Color of lens	Order no. momentary		Order no. latching	
		Plastic front ring	Metallized front ring	Plastic front ring	Metallized front ring
yes	translucent red	1.30.270.051/23xx	1.30.270.071/2300	1.30.270.061/23xx	1.30.270.081/2300
yes	translucent yellow	1.30.270.051/24xx	1.30.270.071/2400	1.30.270.061/24xx	1.30.270.081/2400
yes	translucent green	1.30.270.051/25xx	1.30.270.071/2500	1.30.270.061/25xx	1.30.270.081/2500
yes	translucent blue	1.30.270.051/26xx	1.30.270.071/2600	1.30.270.061/26xx	1.30.270.081/2600
yes	translucent white	1.30.270.051/22xx	1.30.270.071/2200	1.30.270.061/22xx	1.30.270.081/2200
no	opaque slate-grey	1.30.270.051/07xx	1.30.270.071/0700	1.30.270.061/07xx	1.30.270.081/0700
no	opaque black	1.30.270.051/01xx	1.30.270.071/0100	1.30.270.061/01xx	1.30.270.081/0100

RAFIX
22 FS⁺

xx = Front ring color: black = 01, red = 03, yellow = 04, green = 05, blue = 06, slate grey = 07, silver grey = 08

Legending on request.

CONTROL COMPONENTS

RAFIX 22 FS⁺ - ACTUATORS



RAFIX 22 FS⁺ Pushbutton, protruding lens, square collar

Technical data see page 2 - 159

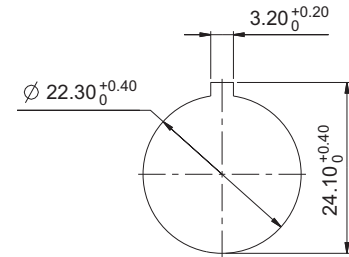
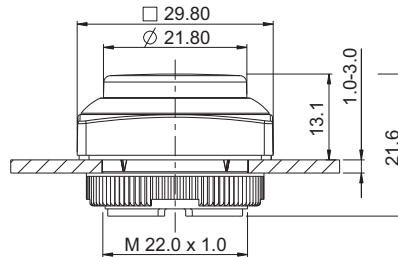

Panel cut-out to IEC 60947-5-1

2

→ Illuminability	Color of lens	Order no. momentary		Order no. latching	
		Plastic front ring	Metallized front ring	Plastic front ring	Metallized front ring
yes	translucent red	1.30.270.251/23xx	1.30.270.271/2300	1.30.270.261/23xx	1.30.270.281/2300
yes	translucent yellow	1.30.270.251/24xx	1.30.270.271/2400	1.30.270.261/24xx	1.30.270.281/2400
yes	translucent green	1.30.270.251/25xx	1.30.270.271/2500	1.30.270.261/25xx	1.30.270.281/2500
yes	translucent blue	1.30.270.251/26xx	1.30.270.271/2600	1.30.270.261/26xx	1.30.270.281/2600
yes	translucent white	1.30.270.251/22xx	1.30.270.271/2200	1.30.270.261/22xx	1.30.270.281/2200
no	opaque slate-grey	1.30.270.251/07xx	1.30.270.271/0700	1.30.270.261/07xx	1.30.270.281/0700
no	opaque black	1.30.270.251/01xx	1.30.270.271/0100	1.30.270.261/01xx	1.30.270.281/0100

xx = Front ring color: black = 01, red = 03, yellow = 04, green = 05, blue = 06, slate grey = 07, silver grey = 08

Legending on request.

RAFIX
22 FS⁺

RAFIX 22 FS⁺ Pushbutton, protruding front ring, square collar

Technical data see page 2 - 159

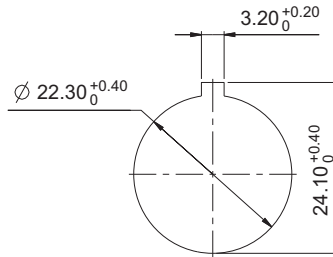
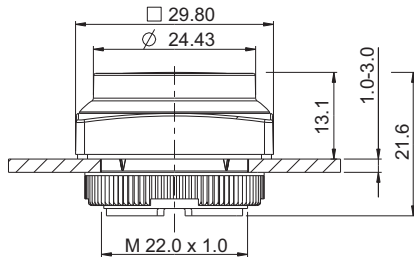

Panel cut-out to IEC 60947-5-1



2

→ Illuminability	Color of lens	Order no. momentary		Order no. latching	
		Plastic front ring	Metallized front ring	Plastic front ring	Metallized front ring
yes	translucent red	1.30.270.451/23xx	1.30.270.471/2300	-	-
yes	translucent yellow	1.30.270.451/24xx	1.30.270.471/2400	-	-
yes	translucent green	1.30.270.451/25xx	1.30.270.471/2500	-	-
yes	translucent blue	1.30.270.451/26xx	1.30.270.471/2600	-	-
yes	translucent white	1.30.270.451/22xx	1.30.270.471/2200	-	-
no	opaque slate-grey	1.30.270.451/07xx	1.30.270.471/0700	-	-
no	opaque black	1.30.270.451/01xx	1.30.270.471/0100	-	-

RAFIX
22 FS⁺

xx = Front ring color: black = 01, red = 03, yellow = 04, green = 05, blue = 06, slate grey = 07, silver grey = 08

Legending on request.

CONTROL COMPONENTS

RAFIX 22 FS⁺ - ACTUATORS

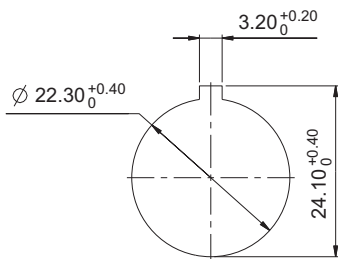

Panel cut-out to IEC 60947-5-1

Approvals



IEC 60947-5-x



UL 508
in preparation



RAFIX 22 FS⁺ Pushbuttons FLEXLAB



- The RAFIX 22 FS⁺ FLEXLAB pushbutton allows individual control component labeling. A DIN A4 label sheet with pre-cut labels which fits in customary office laser printers is available for this option. After the legend inserts are printed, they be detached from the sheet and inserted into the colored lens using the fine stop tabs.

Technical Data

→ General information

Form of lens	flat lens
Color of lens	see order block
Color of front ring	see order block
Form of collar	see order block

→ Dimensions

Dimensions of collar	see order block
Overall height	9.85 mm
Mounting depth	PCB 9.2 mm, QC 27 mm
Mounting hole	22.3 mm
Key grid	30 x 30 mm

→ Mechanical design

Mounting	ring nut
Contact function	see order block
Illuminability	yes
Torque for nut ring	1.2 Nm

→ Mechanical characteristics

Operating travel	4 mm
Robustness max.	100 N

→ Other specifications

Ambient temp. operating min.	-25 °C
Ambient temp. operating max.	+70 °C
Storage temperature min.	-40 °C
Storage temperature max.	+80 °C
Operating life	1,000,000 momentary / 500,000 latching
B10	1,300,000 momentary / 650,000 latching
Degree of protection from front side	IP65 (DIN EN 60529)
Environmental resistance	acc. to IEC 60068-2-14, -30, -33 and -78
Salt spray	IEC 600 68-2-11
ROHS compliant	yes
REACH compliant	yes

2

RAFIX
22 FS⁺

Accessories RAFIX 22 FS⁺ - Pushbuttons FLEXLAB

→ Description	Photo	Order no.	Additional accessories see page
RAFIX 22 FS ⁺ - Contact block PCB silver, Universal, with light conductor		-	2 - 247
RAFIX 22 FS ⁺ - Contact block QC gold, Universal, with light conductor		-	2 - 253
RAFIX 22 FS ⁺ - Contact block QC silver, Universal, with light conductor		-	2 - 256
RAFIX FS - Contact block PCB gold, Universal		-	2 - 243
RAFIX FS - Contact block PCB gold, Universal, with light conductor		-	2 - 242
RAFIX FS - Contact block PCB silver, Universal		-	2 - 248
Fixing spanner for ring nut		5.05.800.062/0000	2 - 145, 2 - 261, 5 - 25

RAFI FLEXLAB

MONTAGEANLEITUNG | ASSEMBLY INSTRUCTIONS | 安装说明

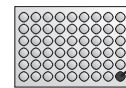

Beschriftungsbogen
Labeling sheet
标签板



Schrifteinlage
Legend Insert
符号插片



Farblendle
Color lens
灯罩

MONTAGE ASSEMBLY 安装

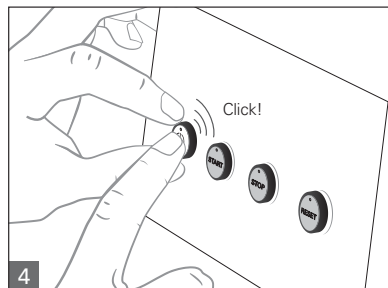
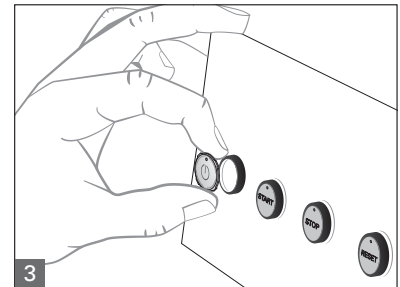
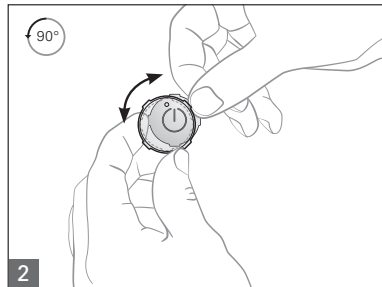
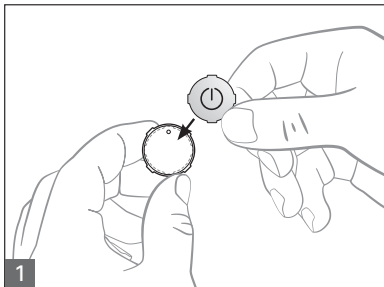

DEMONTAGE DISASSEMBLY 拆除

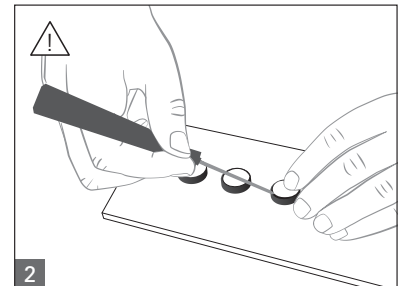
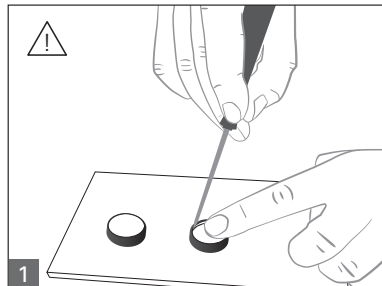

CONTROL COMPONENTS

RAFIX 22 FS⁺ - ACTUATORS



RAFIX 22 FS⁺ Pushbutton FLEXLAB, round collar

Technical data see page 2 - 166

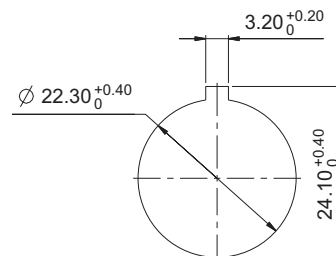
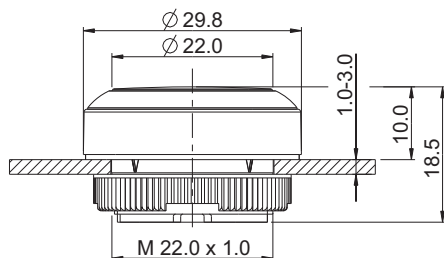

Panel cut-out to IEC 60947-5-1

→	Order no. momentary		Order no. latching	
	Plastic front ring	Metallized front ring	Plastic front ring	Metallized front ring
	1.30.270.901/22xx	1.30.270.921/2200	1.30.270.911/22xx	1.30.270.931/2200

xx = Front ring color: black = 01, red = 03, yellow = 04, green = 05, blue = 06, slate gray = 07, silver gray = 08

Accessoires:

Colored lens for RAFIX FS⁺ Pushbuttons FLEXLAB, colorless: 5.49.263.062/1000

Colored lens for RAFIX FS⁺ Pushbuttons FLEXLAB, red: 5.49.263.062/1300

Colored lens for RAFIX FS⁺ Pushbuttons FLEXLAB, yellow: 5.49.263.062/1400

Colored lens for RAFIX FS⁺ Pushbuttons FLEXLAB, green: 5.49.263.062/1500

Colored lens for RAFIX FS⁺ Pushbuttons FLEXLAB, blue: 5.49.263.062/1600

DIN A4 label sheet with 6x9 lenses in total utility: 5.70.800.200/0000

RAFIX
22 FS⁺



RAFIX 22 FS⁺ Pushbutton FLEXLAB, square collar

Technical data see page 2 - 166

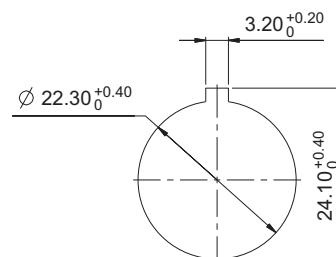
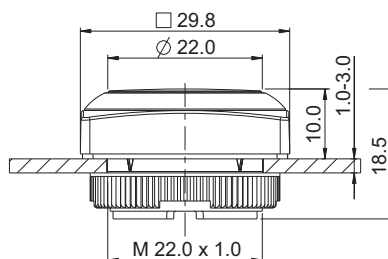

Panel cut-out to IEC 60947-5-1

→ Form of collar	Order no. momentary		Order no. latching	
	Plastic front ring	Metallized front ring	Plastic front ring	Metallized front ring
square	1.30.270.951/22xx	1.30.270.971/2200	1.30.270.961/22xx	1.30.270.981/2200

xx = Front ring color: black = 01, red = 03, yellow = 04, green = 05, blue = 06, slate gray = 07, silver gray = 08

Accessoires:

Colored lens for RAFIX FS⁺ Pushbuttons FLEXLAB, colorless: 5.49.263.062/1000

– Table (continued) –

RAFIX 22 FS⁺ - Pushbuttons FLEXLAB, square collar

Colored lens for RAFIX FS⁺ Pushbuttons FLEXLAB, red: 5.49.263.062/1300
Colored lens for RAFIX FS⁺ Pushbuttons FLEXLAB, yellow: 5.49.263.062/1400
Colored lens for RAFIX FS⁺ Pushbuttons FLEXLAB, green: 5.49.263.062/1500
Colored lens for RAFIX FS⁺ Pushbuttons FLEXLAB, blue: 5.49.263.062/1600
DIN A4 label sheet with 6x9 lenses in total utility: 5.70.800.200/0000

CONTROL COMPONENTS

RAFIX 22 FS⁺ - ACTUATORS

2

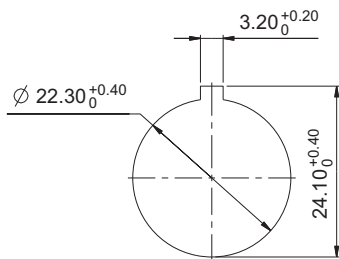

Panel cut-out to IEC 60947-5-1

RAFIX 22 FS⁺ Pushbuttons with protective cap

Technical Data

→ General information

Form of lens	see order block
Color of lens	see order block
Color of front ring	see order block
Form of collar	see order block

→ Dimensions

Dimensions of collar	see order block
Overall height	see order block
Mounting depth	PCB 9.2 mm, QC 27 mm
Mounting hole	22.3 mm
Key grid	30 x 30 mm

→ Mechanical design

Mounting	ring nut
Contact function	see order block
Illuminability	see order block
Torque for nut ring	1.2 Nm

→ Mechanical characteristics

Operating travel	4 mm
Robustness max.	100 N

→ Other specifications

Ambient temp. operating min.	-25 °C
Ambient temp. operating max.	+70 °C
Storage temperature min.	-40 °C
Storage temperature max.	+80 °C
Operating life	1,000,000 momentary / 500,000 latching
B10	1,300,000 momentary / 650,000 latching
Degree of protection from front side	IP65 (DIN EN 60529); IP69K (ISO 20653), water temp. 23 °C +3 °C
Environmental resistance	acc. to IEC 60068-2-14, -30, -33 and -78
Salt spray	IEC 600 68-2-11
ROHS compliant	yes
REACH compliant	yes

Approvals



IEC 60947-5-x





UL 508



Accessories RAFIX 22 FS⁺ - Pushbuttons with protective cap

→ Description	Photo	Order no.	Additional accessories see page
RAFIX 22 FS ⁺ - Contact block PCB silver, Universal, with light conductor		-	2 - 247
RAFIX 22 FS ⁺ - Contact block QC gold, Universal, with light conductor		-	2 - 253
RAFIX 22 FS ⁺ - Contact block QC silver, Universal, with light conductor		-	2 - 256
RAFIX FS - Contact block PCB gold, Universal		-	2 - 243
RAFIX FS - Contact block PCB gold, Universal, with light conductor		-	2 - 242

– Table (continued) –
Accessories RAFIX 22 FS⁺ - Pushbuttons with protective cap

→ Description	Photo	Order no.	Additional accessories see page
RAFIX FS - Contact block PCB silver, Universal		-	2 - 248
Fixing spanner for ring nut		5.05.800.062/0000	2 - 145, 2 - 261, 5 - 25

RAFIX 22 FS⁺ Pushbutton, with protective cap, flush lens, round collar

Technical data see page 2 - 170

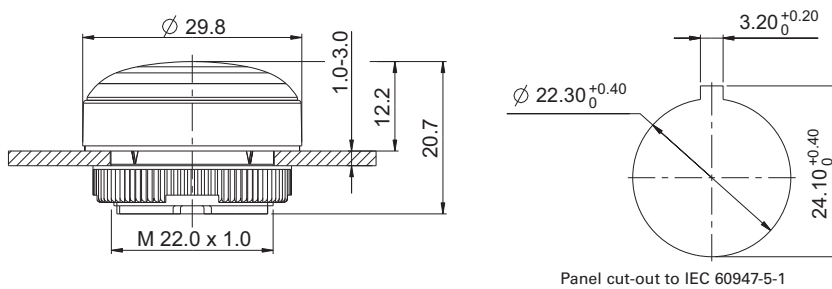

2

RAFIX
22 FS⁺

→ Illuminability	Color of lens	Order no. momentary		Order no. latching	
		Plastic front ring	Metallized front ring	Plastic front ring	Metallized front ring
yes	translucent red	1.30.270.005/23xx	-	-	-
yes	translucent yellow	1.30.270.005/24xx	-	-	-
yes	translucent green	1.30.270.005/25xx	-	-	-
yes	translucent blue	1.30.270.005/26xx	-	-	-
yes	translucent white	1.30.270.005/22xx	-	-	-
no	opaque slate-grey	1.30.270.005/07xx	-	-	-
no	opaque black	1.30.270.005/01xx	-	-	-

Pushbutton with protective cap for use under rugged conditions.

xx = color of front ring: black = 01, silver grey = 08

Legending on request.

CONTROL COMPONENTS

RAFIX 22 FS⁺ - ACTUATORS



RAFIX 22 FS⁺ Pushbutton, with protective cap, flush lens, square collar

Technical data see page 2 - 170

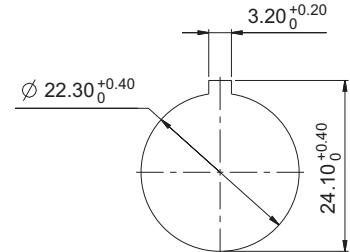
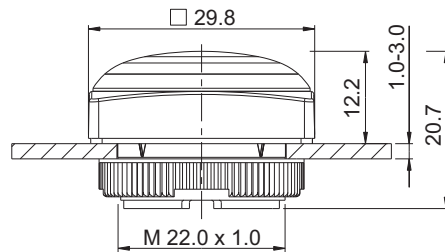

Panel cut-out to IEC 60947-5-1

2

→ Illuminability	Color of lens	Order no. momentary		Order no. latching	
		Plastic front ring	Metallized front ring	Plastic front ring	Metallized front ring
yes	translucent red	1.30.270.055/23xx	-	-	-
yes	translucent yellow	1.30.270.055/24xx	-	-	-
yes	translucent green	1.30.270.055/25xx	-	-	-
yes	translucent blue	1.30.270.055/26xx	-	-	-
yes	translucent white	1.30.270.055/22xx	-	-	-
no	opaque slate-grey	1.30.270.055/07xx	-	-	-
no	opaque black	1.30.270.055/01xx	-	-	-

Pushbutton with protective cap for use under rugged conditions.

xx = Front ring color: black = 01, silver grey = 08

Legending on request.

RAFIX
22 FS⁺

RAFIX 22 FS⁺ Selector switches

→ The illuminated selector switches are provided with translucent handle markings. These are opaque on the non-illuminated versions.

Technical Data

→ General information

Actuator	handle
Marking of handle	see order block
Color of front ring	see order block
Form of collar	see order block

→ Dimensions

Dimensions of collar	see order block
Overall height	22.24 mm
Mounting depth	PCB 9.2 mm, QC 27 mm
Mounting hole	22.3 mm
Key grid	30 x 30 mm

→ Mechanical design

Mounting	ring nut
Contact function	see order block
Illuminability	see order block
Rotating angle	see order block
Torque for nut ring	1.2 Nm

→ Mechanical characteristics

Torque max.	1.5 Nm
-------------	--------

→ Other specifications

Operating life (operations)	500,000 momentary / 300,000 latching
Operating life (operations)	650,000 momentary / 400,000 latching
Degree of protection from front side	IP65 (DIN EN 60529)
Ambient temp. operating min.	-25 °C
Ambient temp. operating max.	+70 °C
Storage temperature min.	-40 °C
Storage temperature max.	+80 °C
Environmental resistance	acc. to IEC 60068-2-14, -30, -33 and -78
Salt spray	IEC 600 68-2-11
ROHS compliant	yes
REACH compliant	yes

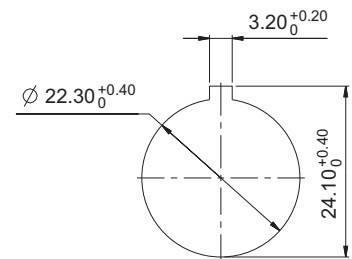

Panel cut-out to IEC 60947-5-1

Approvals



IEC 60947-5-x



UL 508





Accessories RAFIX 22 FS⁺ - Selector switches

Description	Photo	Order no.	Additional accessories see page
RAFIX 22 FS ⁺ - Contact block PCB silver, Universal, with light conductor		-	2 - 247
RAFIX 22 FS ⁺ - Contact block QC gold, Universal, with light conductor		-	2 - 253
RAFIX 22 FS ⁺ - Contact block QC silver, Universal, with light conductor		-	2 - 256
RAFIX FS - Contact block PCB gold, Universal		-	2 - 243
RAFIX FS - Contact block PCB gold, Universal, with light conductor		-	2 - 242

CONTROL COMPONENTS

RAFIX 22 FS⁺ - ACTUATORS

**- Table (continued) -
Accessories RAFIX 22 FS⁺ - Selector switches**

→ Description	Photo	Order no.	Additional accessories see page
RAFIX FS - Contact block PCB silver, Universal		-	2 - 248
Fixing spanner for ring nut		5.05.800.062/0000	2 - 145, 2 - 261, 5 - 25

2







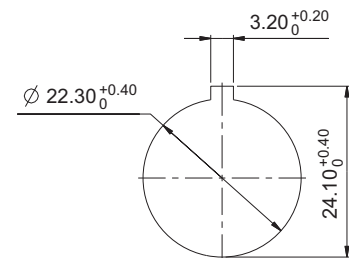
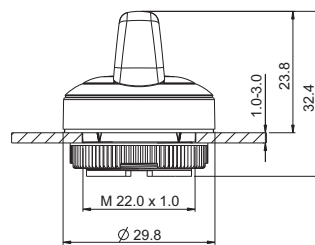

RAFIX 22 FS⁺ Selector switch, round collar

Technical data see page 2 - 173

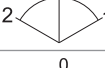

Panel cut-out to IEC 60947-5-1

RAFIX
22 FS⁺

→ Illuminability	Contact function	Rotating angle	Diagram	Order no.	
				Plastic front ring	Metallized front ring
yes	momentary	1 x 40°		1.30.272.001/22xx	1.30.272.002/2200
yes	momentary	2 x 40°		1.30.272.026/22xx	1.30.272.027/2200
yes	latching	1 x 90°, form L		1.30.272.101/22xx	1.30.272.102/2200
yes	latching	1 x 90°, form V		1.30.272.201/22xx	1.30.272.202/2200
yes	latching	2 x 60°		1.30.272.301/22xx	1.30.272.302/2200
yes	latching 1 x 90° and momentary 1 x 40°	1 x 90° and 1 x 40°		1.30.272.426/22xx	1.30.272.427/2200

xx = Front ring color: black = 01, red = 03, yellow = 04, green = 05, blue = 06, slate grey = 07, silver grey = 08

Other contact functions and handle marking colors available on request.

For colored illumination of the handle marking please use colored LED.

RAFIX 22 FS⁺ Selector switch, square collar

Technical data see page 2 - 173

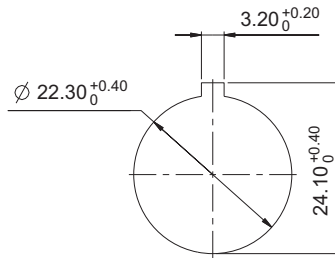
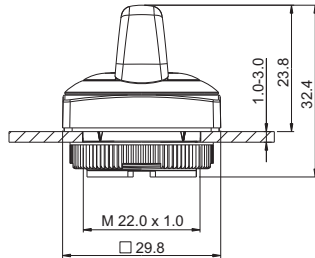

Panel cut-out to IEC 60947-5-1



2

→ Illuminability	Contact function	Rotating angle	Order no.	Plastic front ring	Metallized front ring
yes	momentary	1 x 40°		1.30.272.051/22xx	1.30.272.052/2200
yes	momentary	2 x 40°		1.30.272.076/22xx	1.30.272.077/2200
yes	latching	1 x 90°, form L		1.30.272.151/22xx	1.30.272.152/2200
yes	latching	1 x 90°, form V		1.30.272.251/22xx	1.30.272.252/2200
yes	latching	2 x 60°		1.30.272.351/22xx	1.30.272.352/2200
yes	latching 1 x 90° and momentary 1 x 40°	1 x 90° and 1 x 40°		1.30.272.476/22xx	1.30.272.477/2200

xx = Front ring color: black = 01, red = 03, yellow = 04, green = 05, blue = 06, slate grey = 07, silver grey = 08

Other contact functions and handle marking colors available on request.

For colored illumination of the handle marking please use colored LED.

RAFIX
22 FS⁺

CONTROL COMPONENTS

RAFIX 22 FS⁺ - ACTUATORS

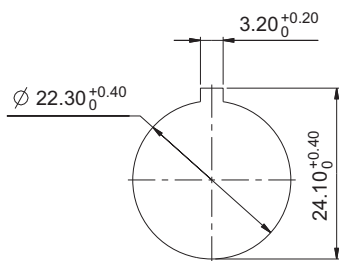

Panel cut-out to IEC 60947-5-1

2

RAFIX
22 FS⁺

Approvals



IEC 60947-5-x



UL 508



RAFIX 22 FS⁺ Keylock switches

→ The locking systems we use are created according to DIN EN 1303 by leading lock manufacturers. They are open, mechanical systems that require occasional maintenance of the machinery or plant operator depending on environmental conditions.

Technical Data

→ General information

Color of front ring	see order block
Form of collar	see order block

→ Dimensions

Dimensions of collar	see order block
Overall height	44.1 mm
Mounting depth	PCB 9.2 mm, QC 27 mm
Mounting hole	22.3 mm
Key grid	30 x 30 mm

→ Mechanical design

Mounting	ring nut
Contact function	see order block
Lock	Micromec
Illuminability	see order block
Wafers	5
Lock type	001
Number of locking positions	500
Main key	on request
Rotating angle	see order block
Key removal position	see order block
Torque for nut ring	1.2 Nm

→ Mechanical characteristics

Torque max.	1.3 Nm
-------------	--------





→ Other specifications

Operating life	300,000 momentary / 50,000 latching / 30,000 with key removal
B10	400,000 momentary / 65,000 latching / 40,000 with key removal
Degree of protection from front side	IP65 (DIN EN 60529)
Ambient temp. operating min.	-25 °C
Ambient temp. operating max.	+70 °C
Storage temperature min.	-40 °C
Storage temperature max.	+80 °C
Environmental resistance	acc. to IEC 60068-2-14, -30, -33 and -78
ESD-strength lock / contact	15 kV
ESD-strength key / front panel	15 kV
Salt spray	IEC 600 68-2-11
ROHS compliant	yes
REACH compliant	yes

Accessories RAFIX 22 FS⁺ - Keylock switch

→ Description	Photo	Order no.	Additional accessories see page
RAFIX FS - Contact block PCB gold, Universal		-	2 - 243

– Table (continued) –
Accessories RAFIX 22 FS⁺ - Keylock switch

→ Description	Photo	Order no.	Additional accessories see page
RAFIX FS - Contact block PCB silver, Universal		-	2 - 248
Fixing spanner for ring nut		5.05.800.062/0000	2 - 145, 2 - 261, 5 - 25
Spare key, (delivery content 1 key)		5.58.007.001/0000	-
Spare key, for double action, e.g. 2 x 90° (delivery content 1 key)		5.58.008.001/0000	-





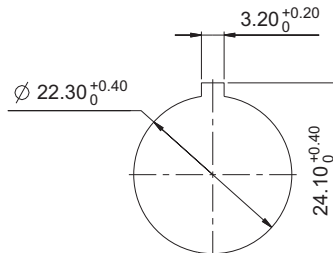
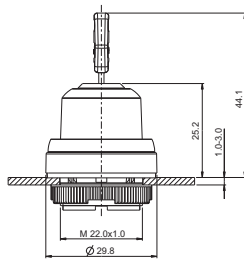

RAFIX 22 FS⁺ Keylock switch, round collar

Technical data see page 2 - 176



Panel cut-out to IEC 60947-5-1



→ Contact function	Rotating angle	Key removal position	Order no.	
			Plastic front ring	Metallized front ring
momentary	1 x 40°		1.30.255.001/xxxx	1.30.255.002/0000
momentary	2 x 40°		1.30.255.101/xxxx	1.30.255.102/0000
latching	1 x 90°, L shape		1.30.255.201/xxxx	1.30.255.202/0000
latching	1 x 90°, L shape		1.30.255.221/xxxx	1.30.255.222/0000
latching	1 x 90°, V shape		1.30.255.301/xxxx	1.30.255.302/0000
latching	1 x 90°, V shape		1.30.255.321/xxxx	1.30.255.322/0000
latching 1 x 90° and momentary 1 x 40°	1 x 90° and 1 x 40°		1.30.255.501/xxxx	1.30.255.502/0000

xxxx = Front ring color: black = 0100, red = 0300, yellow = 0400, green = 0500, blue = 0600, slate grey = 0700, silver grey = 0800

CONTROL COMPONENTS

RAFIX 22 FS⁺ - ACTUATORS

– Table (continued) –

RAFIX 22 FS⁺ - Keylock switch, round collar

Other lock variants available on request.

Included: 2 keys.



RAFIX 22 FS⁺ Keylock switch, square collar

Technical data see page 2 - 176

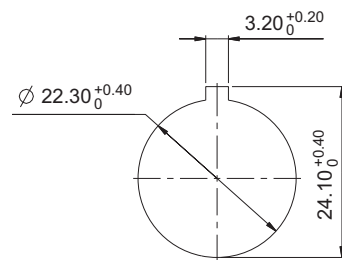
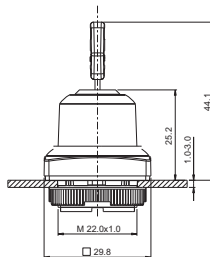

Panel cut-out to IEC 60947-5-1

→ Contact function	Rotating angle	Key removal position	Order no.		
			Plastic front ring	Metallized front ring	
momentary	1 x 40°		0	1.30.255.051/xxxx	1.30.255.052/0000
momentary	2 x 40°		0	1.30.255.151/xxxx	1.30.255.152/0000
latching	1 x 90°, L shape		0	1.30.255.251/xxxx	1.30.255.252/0000
latching	1 x 90°, L shape		0+1	1.30.255.271/xxxx	1.30.255.272/0000
latching	1 x 90°, V shape		0	1.30.255.351/xxxx	1.30.255.352/0000
latching	1 x 90°, V shape		0+1	1.30.255.371/xxxx	1.30.255.372/0000
latching 1 x 90° and momentary 1 x 40°	1 x 90° and 1 x 40°		0	1.30.255.551/xxxx	1.30.255.552/0000

xxxx = Front ring color: black = 0100, red = 0300, yellow = 0400, green = 0500, blue = 0600, slate grey = 0700, silver grey = 0800

Other lock variants available on request.

Included: 2 keys.

2

RAFIX
22 FS⁺

RAFIX 22 FS⁺ Keylock switches compact

→ The locking systems we use are created according to DIN EN 1303 by leading lock manufacturers. They are open, mechanical systems that require occasional maintenance of the machinery or plant operator depending on environmental conditions.

Technical Data

→ General information

Color of front ring	see order block
Form of collar	see order block

→ Dimensions

Dimensions of collar	see order block
Overall height	44.1 mm
Mounting depth	PCB 9.2 mm, QC 27 mm
Mounting hole	22.3 mm
Key grid	30 x 30 mm

→ Mechanical design

Mounting	ring nut
Contact function	see order block
Illuminability	see order block
Wafers	5
Lock type	001
Main key	on request
Rotating angle	see order block
Key removal position	see order block
Torque for nut ring	1.2 Nm

→ Mechanical characteristics

Torque max.	1.3 Nm
-------------	--------

→ Other specifications

Operating life	300,000 momentary / 50,000 latching / 30,000 with key removal
B10	400,000 momentary / 65,000 latching / 40,000 with key removal
Degree of protection from front side	IP65 (DIN EN 60529)
Ambient temp. operating min.	-25 °C
Ambient temp. operating max.	+70 °C
Storage temperature min.	-40 °C
Storage temperature max.	+80 °C
Environmental resistance	acc. to IEC 60068-2-14, -30, -33 and -78
ESD-strength lock / contact	15 kV
ESD-strength key / front panel	15 kV
Salt spray	IEC 600 68-2-11
ROHS compliant	yes
REACH compliant	yes



NEW

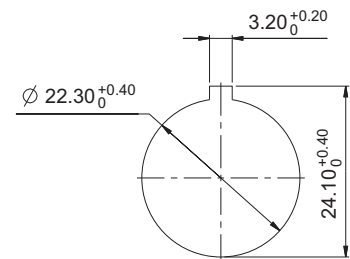

Panel cut-out to IEC 60947-5-1

Approvals



IEC 60947-5-x



UL 508



Accessories RAFIX 22 FS⁺ - Keylock switch compact

→ Description	Photo	Order no.	Additional accessories see page
RAFIX 22 FS ⁺ - Contact block QC gold, Universal, with light conductor		-	2 - 253

CONTROL COMPONENTS

RAFIX 22 FS⁺ - ACTUATORS

2

RAFIX 22 FS⁺

– Table (continued) –
Accessories RAFIX 22 FS⁺ - Keylock switch compact

→ Description	Photo	Order no.	Additional accessories see page
RAFIX 22 FS ⁺ - Contact block QC silver, Universal, with light conductor		-	2 - 256
RAFIX FS - Contact block PCB gold, Universal		-	2 - 243
RAFIX FS - Contact block PCB silver, Universal		-	2 - 248
Fixing spanner for ring nut		5.05.800.062/0000	2 - 145, 2 - 261, 5 - 25
RAFIX FS - Protective cap for keylock switch		5.55.105.454/0111	2 - 267
Spare key, for single action, e.g. 1 x 90° (delivery content 1 key)		5.58.018.001/0000	-



RAFIX 22 FS⁺ Keylock switch compact, round collar

Technical data see page 2 - 179

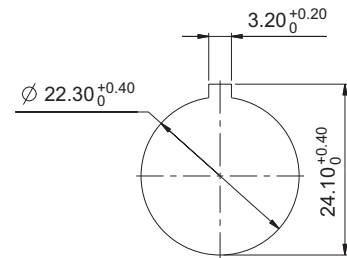
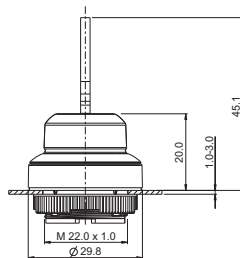

Panel cut-out to IEC 60947-5-1

→ Contact function	Rotating angle	Key removal position	Order no.		
			Plastic front ring	Metallized front ring	
momentary	1 x 40°		0	1.30.275.001/xxxx	1.30.275.002/0000
momentary	2 x 40°		0	1.30.275.101/xxxx	1.30.275.102/0000
latching	1 x 90°, L shape		0+1	1.30.275.221/xxxx	1.30.275.222/0000
latching	1 x 90°, V shape		0+1	1.30.275.321/xxxx	1.30.275.322/0000
latching 1 x 90° and momentary 1 x 40°	1 x 90° and 1 x 40°		0	1.30.275.501/xxxx	1.30.275.502/0000

xxxx = Front ring color: black = 0100, slate grey = 0700, silver grey = 0800

– Table (continued) –
RAFIX 22 FS⁺ - Keylock switch compact, round collar

Other lock variants available on request.
 Included: 2 keys.

RAFIX 22 FS⁺ Keylock switch compact, square collar

Technical data see page 2 - 179

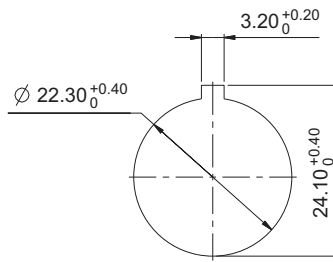
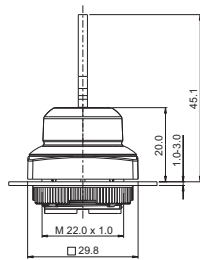

2

→ Contact function	Rotating angle	Key removal position	Order no.		
			Plastic front ring	Metallized front ring	
momentary	1 x 40°		0	1.30.275.051/xxxx	1.30.275.052/0000
momentary	2 x 40°		0	1.30.275.151/xxxx	1.30.275.152/0000
latching	1 x 90°, L shape		0+1	1.30.275.271/xxxx	1.30.275.272/0000
latching	1 x 90°, V shape		0+1	1.30.275.371/xxxx	1.30.275.372/0000
latching 1 x 90° and momentary 1 x 40°	1 x 90° and 1 x 40°		0	1.30.275.551/xxxx	1.30.275.552/0000

xxxx = Front ring color: black = 0100, slate grey = 0700, silver grey = 0800

Other lock variants available on request.
 Included: 2 keys.

RAFIX
22 FS⁺

CONTROL COMPONENTS

RAFIX 22 FS⁺ - ACTUATORS



RAFIX 22 FS⁺ Mushroom-headed pushbuttons

Technical Data

→ General information

Form of lens	conical mushroom form
Color of lens	black
Form of collar	round

→ Dimensions

Mushroom Diameter	30 mm
Overall height	see order block
Mounting depth	PCB 9.2 mm, QC 27 mm
Mounting hole	22.3 mm
Diameter of collar	29.8 mm

→ Mechanical design

Mounting	ring nut
Contact function	see order block
Illuminability	see order block
Reset	see order block
Torque for nut ring	1.2 Nm

→ Mechanical characteristics

Robustness max.	100 N
-----------------	-------

→ Other specifications

Ambient temp. operating min.	-25 °C
Ambient temp. operating max.	+70 °C
Storage temperature min.	-40 °C
Storage temperature max.	+80 °C
Operating life	50,000
B10	65,000
Degree of protection from front side	IP65 (DIN EN 60529)
Environmental resistance	acc. to IEC 60068-2-14, -30, -33 and -78
Salt spray	IEC 600 68-2-11
Robustness	acc. to IEC 600 68-2-3 und 2-30
ROHS compliant	yes
REACH compliant	yes

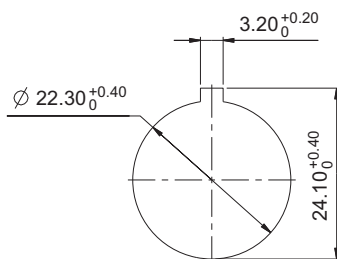

Panel cut-out to IEC 60947-5-1

2

RAFIX
22 FS⁺

Approvals



IEC 60947-5-x



UL 508
in preparation



Accessories RAFIX 22 FS⁺ - Mushroom-headed pushbutton

→ Description

Description	Photo	Order no.	Additional accessories see page
RAFIX 22 FS ⁺ - Contact block PCB silver, E-Stop		-	2 - 249
RAFIX 22 FS ⁺ - Contact block QC gold, E-Stop, with light conductor		-	2 - 253
RAFIX 22 FS ⁺ - Contact block QC silver, E-Stop, with light conductor		-	2 - 257
RAFIX FS - Contact block PCB gold, E-Stop		-	2 - 244
Fixing spanner for ring nut		5.05.800.062/0000	2 - 145, 2 - 261, 5 - 25

RAFIX 22 FS⁺ Mushroom-headed pushbutton

Technical data see page 2 - 182

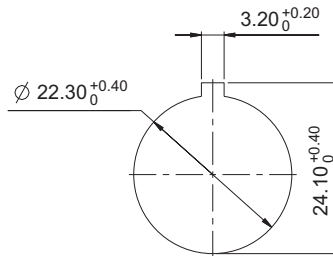
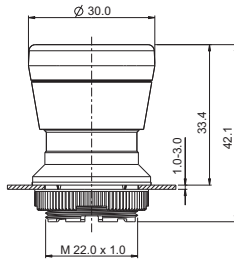

Panel cut-out to IEC 60947-5-1



→ Contact function	Illuminability	Reset	Order no.
momentary	yes	-	1.30.276.201/2200
momentary	no	-	1.30.276.701/0000
latching	yes, lens translucent transparent	by pulling	1.30.276.101/2200
latching	yes, lens translucent transparent	by clockwise rotation	1.30.276.001/2200
latching	no	by pulling	1.30.276.601/0000
latching	no	by clockwise rotation	1.30.276.501/0000

Only use with contact blocks type E-Stop.

CONTROL COMPONENTS

RAFIX 22 FS⁺ - ACTUATORS

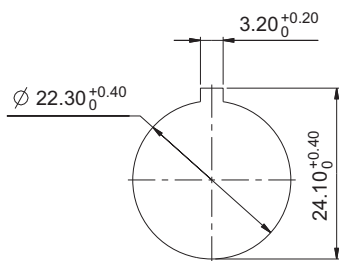

Panel cut-out to IEC 60947-5-1

2

RAFIX
22 FS⁺

Approvals



IEC 60947-5-x



UL 508 (rotation)
UL 508
in preparation
(pulling)



RAFIX 22 FS⁺ Emergency stop pushbuttons

→ The emergency stop pushbuttons comply with IEC 60 947 and VDE 0113 Part 1.

They are designed dupe-proof according to EN 418 with a positive mechanical movement sequence. A certain operating force must be exerted at the action point in order to prevent inadvertent operation. The pushbutton latches when pressed.

The special shape of the actuator prevents the emergency stop pushbutton from being blocked. This means that the emergency stop process - once initiated - cannot be impeded by any jamming objects.

Please only combine with „emergency stop“ contact blocks.
Original operating instructions see Appendix.

Technical Data

→ General information

Form of lens	conical mushroom form
Color of lens	red
Form of collar	round

→ Dimensions

Mushroom Diameter	30 mm
Overall height	see order block
Mounting depth	PCB 9.2 mm, QC 27 mm
Mounting hole	22.3 mm
Diameter of collar	see order block

→ Mechanical design

Mounting	ring nut
Contact function	latching
Illuminability	see order block
Reset	see order block
Torque for nut ring	1.2 Nm









→ Mechanical characteristics

Robustness max.	100 N
-----------------	-------

→ Other specifications

Ambient temp. operating min.	-25 °C
Ambient temp. operating max.	+70 °C
Robustness	acc. to IEC 600 68-2-3 und 2-30
Storage temperature min.	-40 °C
Storage temperature max.	+80 °C
Operating life (operations)	50,000
B10	65,000
Degree of protection from front side	see order block
Environmental resistance	acc. to IEC 60068-2-14, -30, -33 and -78
Salt spray	IEC 600 68-2-11
ROHS compliant	yes
REACH compliant	yes

Accessories RAFIX 22 FS⁺ - Emergency stop pushbutton

→ Description	Photo	Order no.	Additional accessories see page
Emergency stop label, Ø 22.3 mm		-	2 - 82, 2 - 149, 2 - 264, 5 - 21
RAFIX FS - Contact block PCB gold, E-Stop		-	2 - 244
RAFIX FS - Contact block PCB gold, E-Stop, with light conductor		-	2 - 243
RAFIX FS - Contact block PCB silver, E-Stop		-	2 - 249
RAFIX FS - Contact block PCB silver, E-Stop, with light conductor		-	2 - 248
RAFIX FS - Contact block QC gold, E-Stop, with light conductor		-	2 - 253
RAFIX FS - Contact block QC silver, E-Stop, with light conductor		-	2 - 257
Protective Collar for emergency stop RAFIX 22 FS ⁺		5.00.456.001/0000	2 - 265
Fixing spanner for ring nut		5.05.800.062/0000	2 - 145, 2 - 261, 5 - 25

RAFIX 22 FS⁺ Emergency stop pushbutton, reset by rotation

Technical data see page 2 - 184

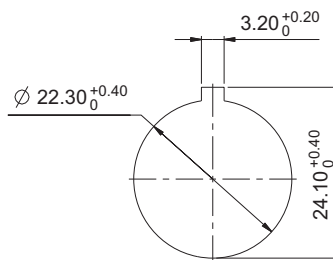
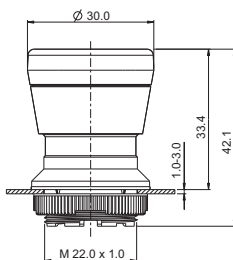

Panel cut-out to IEC 60947-5-1



→ Reset	Illuminability	Degree of protection from front side	Order no.
by clockwise rotation	yes, lens translucent	IP65 (DIN EN 60529)	1.30.273.001/2200
by clockwise rotation	yes, lens translucent red	IP65 (DIN EN 60529)	1.30.273.001/2300
by clockwise rotation	no	IP65 (DIN EN 60529)	1.30.273.501/0300

Only use with E-stop contact blocks

CONTROL COMPONENTS

RAFIX 22 FS⁺ - ACTUATORS



RAFIX 22 FS⁺ Emergency stop pushbutton, reset by pulling (IP65, IP69K)

Technical data see page 2 - 184

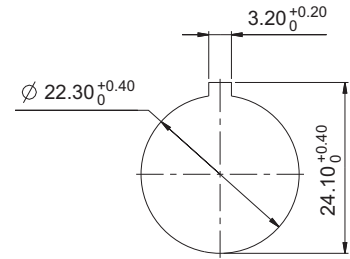
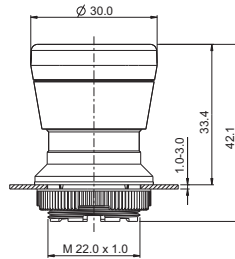

Panel cut-out to IEC 60947-5-1

→ Reset	Illuminability	Degree of protection from front side	Order no.
by pulling	yes, lens translucent	IP65 (DIN EN 60529); IP69K (ISO 20653)	1.30.273.101/2200
by pulling	yes, lens translucent red	IP65 (DIN EN 60529); IP69K (ISO 20653)	1.30.273.101/2300
by pulling	no	IP65 (DIN EN 60529); IP69K (ISO 20653)	1.30.273.601/0300

Only use with E-stop contact blocks

RAFIX
22 FS⁺

RAFIX 22 FS⁺ Emergency stop pushbuttons compact

→ The emergency stop pushbuttons compact comply with IEC 60 947 and VDE 0113 Part 1.

They are designed dupe-proof according to EN 418 with a positive mechanical movement sequence. A certain operating force must be exerted at the action point in order to prevent inadvertent operation. The pushbutton latches when pressed.

The special shape of the actuator prevents the emergency stop pushbutton from being blocked. This means that the emergency stop process - once initiated - cannot be impeded by any jamming objects.

Only use with E-stop contact blocks

Original operating instructions see Appendix.

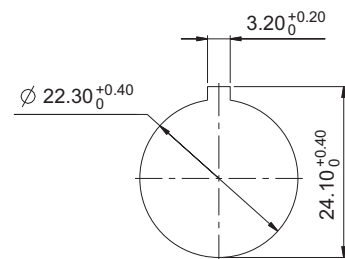
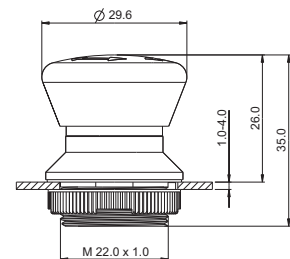

Panel cut-out to IEC 60947-5-1

Technical Data

→ General information

Form of lens	conical mushroom form
Color of lens	red
Form of collar	round

→ Dimensions

Mushroom Diameter	30 mm
Overall height	see order block
Mounting depth	PCB 9.2 mm, QC 27 mm
Mounting hole	22.3 mm
Diameter of collar	see order block

→ Mechanical design

Mounting	ring nut
Contact function	latching
Illuminability	see order block
Reset	see order block
Torque for nut ring	1.2 Nm

→ Mechanical characteristics

Robustness max.	100 N
-----------------	-------

→ Other specifications

Ambient temp. operating min.	-25 °C
Ambient temp. operating max.	+70 °C
Robustness	acc. to IEC 600 68-2-3 und 2-30
Storage temperature min.	-40 °C
Storage temperature max.	+80 °C
Operating life (operations)	50,000
B10	65,000
Degree of protection from front side	IP65 (DIN EN 60529)
Environmental resistance	acc. to IEC 60068-2-14, -30, -33 and -78
Salt spray	IEC 600 68-2-11

Approvals



IEC 60947-5-x



UL 508
in preparation



CONTROL COMPONENTS

RAFIX 22 FS⁺ - ACTUATORS

2

Accessories RAFIX 22 FS⁺ - Emergency stop pushbutton compact

→ Description	Photo	Order no.	Additional accessories see page
Emergency stop label, Ø 22.3 mm		-	2 - 82, 2 - 149, 2 - 264, 5 - 21
RAFIX 22 FS ⁺ - Contact block PCB silver, E-Stop		-	2 - 249
RAFIX 22 FS ⁺ - Contact block PCB silver, E-Stop, with light conductor		-	2 - 248
RAFIX 22 FS ⁺ - Contact block QC gold, E-Stop, with light conductor		-	2 - 253
RAFIX 22 FS ⁺ - Contact block QC silver, E-Stop, with light conductor		-	2 - 257
RAFIX FS - Contact block PCB gold, E-Stop		-	2 - 244
RAFIX FS - Contact block PCB gold, E-Stop, with light conductor		-	2 - 243
Fixing spanner for ring nut		5.05.800.062/0000	2 - 145, 2 - 261, 5 - 25

RAFIX 22 FS⁺



RAFIX 22 FS⁺ Emergency stop pushbutton compact, reset by rotation

Technical data see page 2 - 187

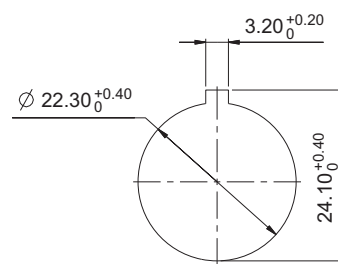
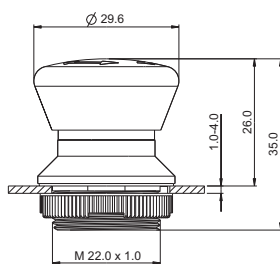

Panel cut-out to IEC 60947-5-1

→ Reset	Illuminability	Degree of protection from front side	Order no.
by rotating	yes	IP65 (DIN EN 60529)	1.30.273.301/2200

Only use with E-stop contact blocks

RAFIX 22 FS⁺ Emergency stop pushbuttons „Plus 1“

→ RAFIX 22 FS „Plus 1“

Emergency stop pushbutton with 2 NC and 1 signal contact.

This special emergency stop pushbutton offers two redundant normally-closed contacts for the emergency off / emergency stop function and an additional signal contact. Unique design: 3 contacts accommodated in very compact dimensions (mounting depth 9.2 or 27 mm).

2 normally-closed (NC) contacts

Redundancy is more and more often a requirement for safety applications in mechanical engineering and control system development and helps to minimise the probability of failure of a system.

1 signal contact

The third contact – a normally-open contact – may be used, for example, for sending an information signal to a monitoring unit or master safety controller. The safety controller may then initiate a controlled shutdown, depending on the location and type of the hazard indicated.

The signal contact is only for impulse function and must not be used as a lasting NO contact.

The emergency stop pushbutton complies with the current standards. The positively guided mechanical movement of the pushbutton makes it dupe-proof according to DIN EN ISO 13850.

A RAFIX 22 FS „Plus 1“ emergency stop unit consists of a special emergency stop pushbutton and a suitable emergency stop contact block which can either be mounted directly (quick-connect terminals) or placed on a printed circuit board (THT version).

Only use with emergency stop „Plus 1“ contact blocks.

Original operating instructions see Appendix.

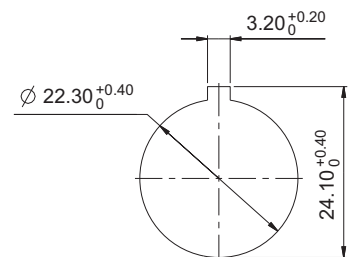
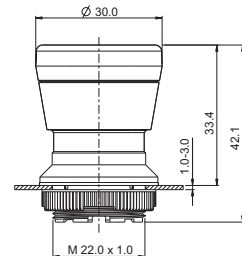

Panel cut-out to IEC 60947-5-1

Technical Data

→ General information

Form of lens	conical mushroom form
Color of lens	red
Form of collar	round

→ Dimensions

Mushroom Diameter	30 mm
Overall height	33.2 mm
Mounting depth	PCB 9.2 mm, QC 27 mm
Mounting hole	22.3 mm
Diameter of collar	29.8 mm

→ Mechanical design

Mounting	ring nut
Contact function	latching
Illuminability	no
Reset	see order block
Torque for nut ring	1.2 Nm

→ Mechanical characteristics

Robustness max.	100 N
-----------------	-------

→ Other specifications

Approvals



IEC 60947-5-x



UL 508
in preparation



CONTROL COMPONENTS

RAFIX 22 FS⁺ - ACTUATORS

2

- Technical data (continued) – RAFIX 22 FS⁺ - Emergency stop pushbutton „Plus 1“

Ambient temp. operating min.	-25
Ambient temp. operating max.	+70
Robustness	acc. to IEC 600 68-2-3 und 2-30
Storage temperature min.	-40
Storage temperature max.	+80
Operating life	50,000
B10	65,000
Degree of protection from front side	see order block
Environmental resistance	acc. to IEC 60068-2-14, -30, -33 and -78
Salt spray	IEC 600 68-2-11
ROHS compliant	yes
REACH compliant	yes

Accessories RAFIX 22 FS⁺ - Emergency stop pushbutton „Plus 1“

→ Description	Photo	Order no.	Additional accessories see page
Emergency stop label, Ø 22.3 mm		-	2 - 82, 2 - 149, 2 - 264, 5 - 21
RAFIX 22 FS ⁺ - Contact block PCB gold, E-Stop „Plus 1“		1.20.126.414/0000	2 - 244
RAFIX 22 FS ⁺ - Contact block QC gold, E-Stop „Plus 1“		1.20.126.514/0000	2 - 254
Fixing spanner for ring nut		5.05.800.062/0000	2 - 145, 2 - 261, 5 - 25

RAFIX
22 FS⁺



RAFIX 22 FS⁺ Emergency stop pushbutton „Plus 1“, reset by rotation

Technical data see page 2 - 189

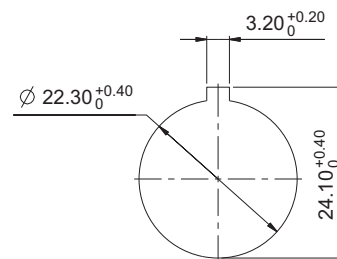
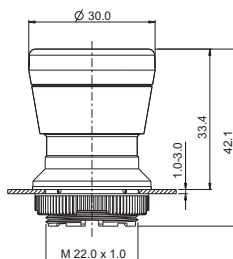

Panel cut-out to IEC 60947-5-1

→ Reset	Illuminability	Degree of protection from front side	Order no.
by clockwise rotation	no	IP65 (DIN EN 60529)	1.30.273.502/0300

Only combine with E- stop contact block „Plus 1“

RAFIX 22 FS⁺ Emergency stop pushbutton „Plus 1“ reset by pulling (IP65, IP69K)

Technical data see page 2 - 189

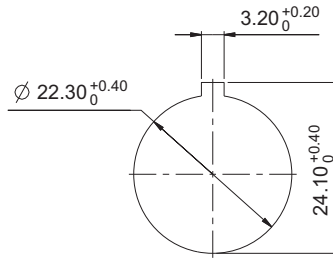
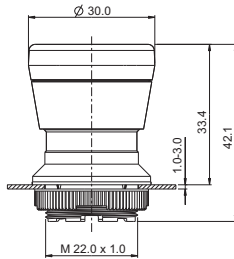

Panel cut-out to IEC 60947-5-1



2

→ Reset	Illuminability	Degree of protection from front side	Order no.
by pulling	no	IP65 (DIN EN 60529); IP69K (ISO 20653)	1.30.273.602/0300

Only combine with E- stop contact block „Plus 1“

RAFIX
22 FS⁺

CONTROL COMPONENTS

RAFIX 22 FS⁺ - ACTUATORS

RAFIX 22 FS⁺ Potentiometer drives

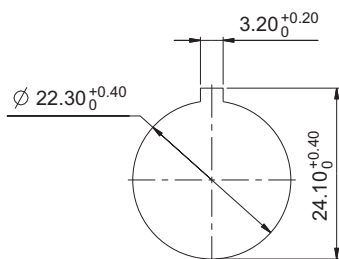

Panel cut-out to IEC 60947-5-1

Technical Data

→ General information

Actuator	knob
Color of knob	see order block
Front ring	see order block
Form of collar	see order block

→ Dimensions

Dimensions of collar	see order block
Overall height	26 mm
Mounting depth	according to potentiometer
Mounting hole	22.3 mm
Key grid	according to potentiometer

→ Mechanical design

Mounting	ring nut
Torque for nut ring	1.2 Nm

→ Other specifications

Degree of protection from front side	IP65 (DIN EN 60529)
Storage temperature min.	-40 °C
Storage temperature max.	+80 °C
Environmental resistance	acc. to IEC 60068-2-14, -30, -33 and -78
Salt spray	IEC 600 68-2-11
ROHS compliant	yes
REACH compliant	yes

2

RAFIX
22 FS⁺

Approvals



IEC 60947-5-x

Accessories RAFIX 22 FS⁺ - Potentiometer drive

→ Description	Photo	Order no.	Additional accessories see page
Fixing spanner for ring nut		5.05.800.062/0000	2 - 145, 2 - 261, 5 - 25

RAFIX 22 FS⁺ Potentiometer drive, round collar

Technical data see page 2 - 192

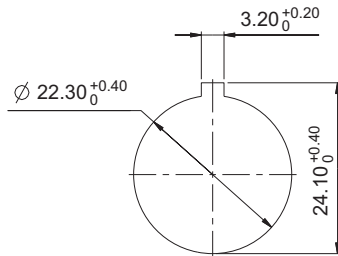

Panel cut-out to IEC 60947-5-1



→ Front ring	Color of knob	Order no.
plastic slate-grey	opaque slate-grey	1.30.258.001/0700

For potentiometers with 6 mm shaft diameter and 50 mm shaft length. Potentiometer not included.

RAFIX 22 FS⁺ Potentiometer drive, square collar

Technical data see page 2 - 192

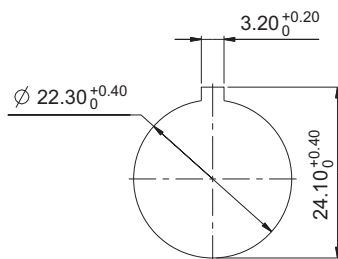

Panel cut-out to IEC 60947-5-1



→ Front ring	Color of knob	Order no.
plastic slate-grey	opaque slate-grey	1.30.258.021/0700

For potentiometers with 6 mm shaft diameter and 50 mm shaft length. Potentiometer not included.

CONTROL COMPONENTS

RAFIX 22 FS⁺ - INDICATORS

RAFIX 22 FS⁺ Signal indicators



Technical Data

→ General information

Form of lens	see order block
Color of lens	see order block
Form of collar	see order block

→ Dimensions

Length of collar	see order block
Overall height	see order block
Mounting depth	PCB 9.2 mm, QC 27 mm
Mounting hole	22.3 mm
Key grid	30 x 30 mm

→ Mechanical design

Mounting	ring nut
Illuminability	yes
Torque for nut ring	1.2 Nm

→ Other specifications

Degree of protection from front side	IP65 (DIN EN 60529)
Ambient temp. operating min.	-25 °C
Ambient temp. operating max.	+70 °C
Storage temperature min.	-40 °C
Storage temperature max.	+80 °C
Environmental resistance	acc. to IEC 60068-2-14, -30, -33 and -78
Salt spray	IEC 600 68-2-11
ROHS compliant	yes
REACH compliant	yes

Approvals



IEC 60947-5-x



UL 508



2

RAFIX
22 FS⁺

Accessories RAFIX 22 FS⁺ - Signal indicator

→ Description	Photo	Order no.	Additional accessories see page
LED 3 mm		-	-
LED base for 3 mm THT LED, used in signal indicators, for RAFIX FS PCB		-	2 - 263
QC LED base for signal indicators		-	2 - 261
Fixing spanner for ring nut		5.05.800.062/0000	2 - 145, 2 - 261, 5 - 25

RAFIX 22 FS⁺ Signal indicator, round collar, flat version

Technical data see page 2 - 194

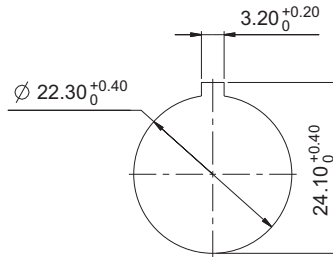
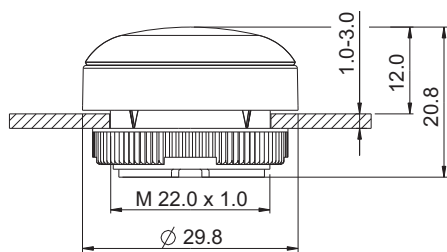

Panel cut-out to IEC 60947-5-1



2

→ Form of collar	Color of lens	Order no.
round	translucent red	1.74.508.001/2300
round	translucent yellow	1.74.508.001/2400
round	translucent green	1.74.508.001/2500
round	translucent blue	1.74.508.001/2600
round	translucent white	1.74.508.001/2200

Legending on request.

RAFIX
22 FS⁺

RAFIX 22 FS⁺ Signal indicator, round collar, high version

Technical data see page 2 - 194

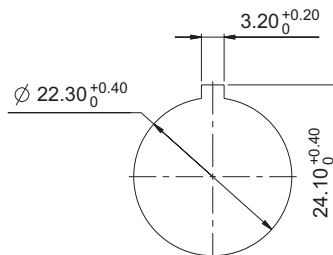
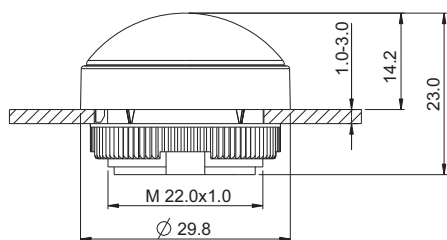

Panel cut-out to IEC 60947-5-1



→ Form of collar	Color of lens	Order no.
round	translucent red	1.74.508.011/2300
round	translucent yellow	1.74.508.011/2400
round	translucent green	1.74.508.011/2500
round	translucent blue	1.74.508.011/2600
round	translucent white	1.74.508.011/2200

CONTROL COMPONENTS

RAFIX 22 FS⁺ - INDICATORS



RAFIX 22 FS⁺ Signal indicator, square collar, flat version

Technical data see page 2 - 194

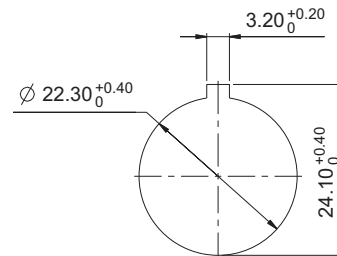
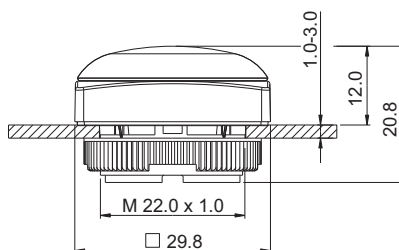

Panel cut-out to IEC 60947-5-1

2

→ Form of collar	Color of lens	Order no.
square	translucent red	1.74.508.051/2300
square	translucent yellow	1.74.508.051/2400
square	translucent green	1.74.508.051/2500
square	translucent blue	1.74.508.051/2600
square	translucent white	1.74.508.051/2200

RAFIX
22 FS⁺

Legending on request.



RAFIX 22 FS⁺ Signal indicator, square collar, high version

Technical data see page 2 - 194

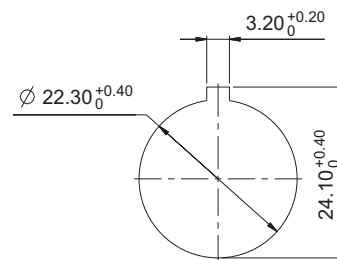
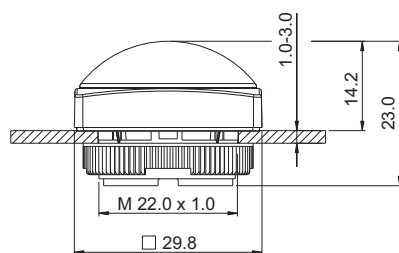

Panel cut-out to IEC 60947-5-1

→ Form of collar	Color of lens	Order no.
square	translucent red	1.74.508.061/2300
square	translucent yellow	1.74.508.061/2400
square	translucent green	1.74.508.061/2500
square	translucent blue	1.74.508.061/2600
square	translucent white	1.74.508.061/2200

CONTROL COMPONENTS

RAFIX 22 FS⁺ - INDICATORS



GET IN
TOUCH

RAFIX 22 FS⁺

Fast & Slim. Everything else is a thing of the past

RAFIX 22 FS⁺ control components are fast and slim. Fast because they're simple to connect, either on a PCB or directly with quick-connect terminals. Slim because of their extremely small mounting depth that leaves plenty of room for additional components and individual designs.

More information: www.RAFIX22FS.de

www.rafi.de

RAFI

2

RAFIX
22 FS⁺

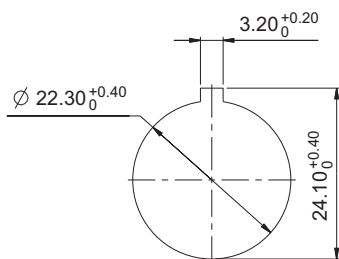

Panel cut-out to IEC 60947-5-1

Approvals



IEC 60947-5-x



UL 508

RAFIX 22 FS⁺ USB feedthroughs

→ Rugged USB feedthroughs for 22.3 mm mounting hole diameter matching the RAFIX 22 FS and RAFIX 22 QR actuator series. The USB feedthrough provides sturdy installation of an easily accessible USB slot in front panels of controllers and IPCs and can be used, for example, to connect a keyboard for maintenance purposes or a USB stick for a software update. The port on the rear accommodates commercially available USB cables of varying lengths with B-type connector. A sealing cap protects the slot and ensures a degree of protection to IP 65. For assembly, simply insert the feedthrough from the front side into the mounting hole and fasten it by means of a ring nut from the rear. The depth behind panel is 27.7 mm. The color of the front ring can be freely selected so that the USB feedthrough can be matched in appearance to the customer-specific design.

Technical Data

→ General information

Form of lens	see order block
Color of lens	see order block
Color of front ring	see order block
Form of collar	see order block

→ Dimensions

Dimensions of collar	see order block
Overall height	11.3 mm
Mounting depth	see order block
Mounting hole	22.3 mm
Key grid	30 x 30 mm

→ Mechanical design

Mounting	ring nut
Front connection	USB Type A
Rear connection	USB Type B
Torque for nut ring	1.2 Nm

→ Other specifications

Ambient temp. operating min.	-25 °C
Ambient temp. operating max.	+70 °C
Storage temperature min.	-40 °C
Storage temperature max.	+80 °C
Operating life	1500 operations
Degree of protection from front side	IP65 (DIN EN 60529) with closed sealing cap
Relative humidity	5 bis 95% (non condensed)
Shock resistance to IEC 60068-2-27 (EN 61131-2)	50 g at 11 ms half sine amplitude
Vibration resistance according to IEC 600 68-2-6 (EN 61131-2)	5 g at 10...500 Hz
ROHS compliant	yes
REACH compliant	yes

Accessories RAFIX 22 FS⁺ - USB feedthrough

→ Description	Photo	Order no.	Additional accessories see page
Fixing spanner for ring nut		5.05.800.062/0000	2 - 145, 2 - 261, 5 - 25

RAFIX 22 FS⁺ USB feedthrough, round collar

Technical data see page 2 - 198

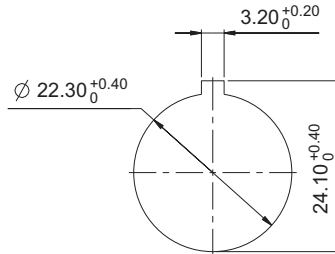
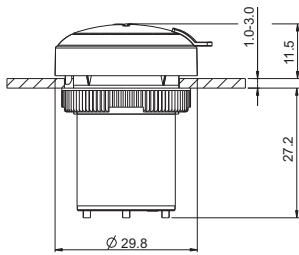

Panel cut-out to IEC 60947-5-1



→ Color of front ring	Front connection	Rear connection	Order no.
slate-grey	USB Type A	USB Type B	1.30.279.001/0707
metallized	USB Type A	USB Type B	1.30.279.021/0700

RAFIX 22 FS⁺ USB feedthrough, square collar

Technical data see page 2 - 198

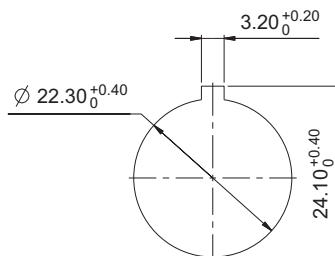
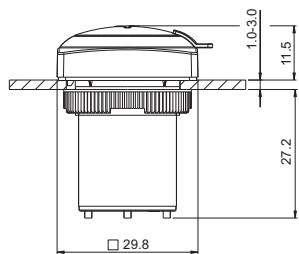

Panel cut-out to IEC 60947-5-1



→ Color of front ring	Front connection	Rear connection	Order no.
slate-grey	USB Type A	USB Type B	1.30.279.051/0707
metallized	USB Type A	USB Type B	1.30.279.071/0700



RAFIX 22 FSR

Extremely rugged and economically unbeatable! RAFIX 22 FSR features proven RAFIX FS technology and a rugged design. The control components have a low mounting depth which saves a lot of space and enables fast installation. Pushbuttons and actuators provide for quick orientation and a clearly distinctive design thanks to their individually combinable colors and shapes.

CONTROL COMPONENTS

RAFIX 22 FSR

Content

RAFIX 22 FSR Pushbuttons	2 - 206
RAFIX 22 FSR Pushbutton	2 - 207
RAFIX 22 FSR Selector switches	2 - 208
RAFIX 22 FSR Selector switch	2 - 209
RAFIX 22 FSR Keylock switches	2 - 210
RAFIX 22 FSR Keylock switch	2 - 211
RAFIX 22 FSR Emergency stop pushbuttons	2 - 212
RAFIX 22 FSR Emergency stop pushbutton, metal mushroom	2 - 213
RAFIX 22 FSR Emergency stop pushbutton, plastic mushroom	2 - 214
RAFIX 22 FSR Signal indicators	2 - 215
RAFIX 22 FSR Signal indicator	2 - 216

2

RAFIX
22 FSR

RAFIX 22 FSR

WHEN THE GOING GETS TOUGH

Harsh weather conditions. Dirt and dust are swirling around, and the sun is beating down mercilessly. It's critical to keep pushing ahead – fast. A dirty glove dripping with lubricants pounds a key vigorously, and work goes on!

The cloud cover is increasing, it's raining, the temperature drops below the freezing point and it starts sleeting. Ice crystals stick to the operating elements, but the machinery keeps on running. Dust, dirt, lubricants, moisture, heat and

cold: Close to the limit, solutions are required which are extremely rugged, hard-wearing and tough-natured. RAFIX 22 FSR has taken on this challenge. Under the most adverse conditions, these actuators and contact blocks demonstrate their strengths: ruggedness and know-how based on proven FS technology. A series specifically developed for outdoor applications, RAFIX FSR withstands extreme conditions – with no ifs, ands or buts.



2

RAFIX
22 FSR

Close to the limit

Extremely rugged and economically unbeatable! RAFIX 22 FSR features proven FS technology and a rugged design. The contact blocks have a low mounting depth, which saves an enormous amount of space and enables fast installation. The pushbuttons and actuators ensure quick orientation along with a highly distinctive design thanks to their individually combinable colors and shapes.

The top performer

Dirt: No matter whether it is exposed to industrial lubricants or soiling which occurs naturally during outdoor use – the series is extremely resistant and delivers what it promises.

Rugged: The actuator mechanism is not affected even by harsh conditions and severe external impacts.

Climate: Intense sunlight, heavy rain, hail or snow – RAFIX 22 FSR easily withstands adverse weather conditions.

Moisture: Waterproof actuators (IP65 and IP69K) ensure dependable operation.

SLIM

- Designs with PCB contact blocks feature a distance between the front panel and printed circuit board of only 9.2 mm.
- With QC contact blocks, only 27 mm of space is needed behind the front panel.

Combinable with all contact blocks and accessories with RAFIX FS technology

- PCB or QC contact blocks
- Gold contacts from 5 V or silver contacts up to 250 V
- Short-travel adapter enables short-travel actuation (1 mm switching travel) with perceptible key click
- Variable illumination, compatible with 3 mm THT LEDs / SMT LEDs or LED clip



CONTROL COMPONENTS

RAFIX 22 FSR CONTROL COMPONENTS

RAFIX 22 FSR

The RAFIX 22 FSR series has a variety of actuators and signal indicators

Pushbuttons

- Illuminable
- With protective cap

Emergency stop

- Unlocked by pulling
- Illuminated (optional)
- Metal version (optional)

Selector switches

- Rotating angle 40°, 60° or 90°
- Latching or momentary
- Illuminable

Keylock switches

- Rotating angle 40° or 90°
- Latching or momentary
- With protective cap

Signal indicators

- Green, yellow, red, blue or white

Approvals

- IEC 60947-5-1/5
- UL
- CCC

Safe and reliable

The actuators in the RAFIX 22 FSR series ensure a degree of protection to at least IP65 (DIN EN 60529), IP69K (ISO 20653), which makes them suitable for many diverse applications.

Long operating life

The mechanical design of all actuators is optimally suited for long-lasting operation even in heavily used panels.

Mounting hole

The actuators in the RAFIX 22 FSR series are suitable for 22.3 mm panel cut-outs according to IEC 60947-5-1.

All actuators are equipped with a locating pip. This locating pip ensures a perfect fit for actuators and contact blocks with PCB-mounted components and is therefore essential for designs including these contact blocks.

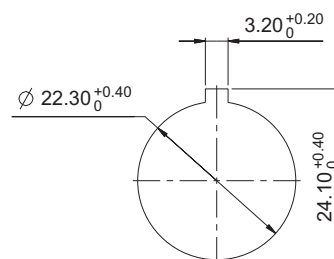

Grid spacing

The design principle makes it possible to use a minimum grid spacing of 35 mm x 35 mm.

When choosing the grid spacing, it is recommended to consider any external legending required (for example, using label strips inserted into the front panel).



RAFIX 22 FSR

RAFIX 22 FSR with PCB contact block

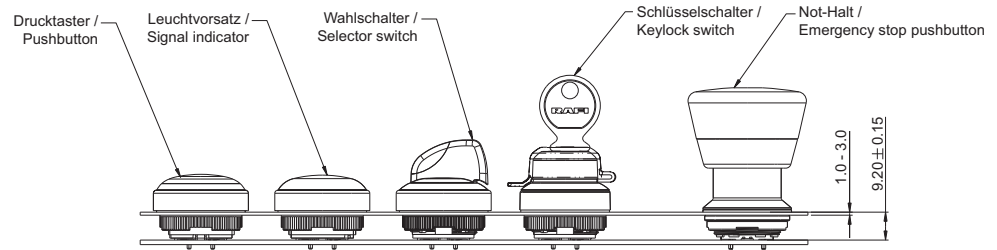

For printed circuit board hole patterns, see RAFIX 22 FS-Technology contact blocks

<p>Formula for spacer length</p> $\frac{9.2 \text{ mm} - \text{Front panel thickness}}{\text{Length of spacer}}$
--

RAFIX 22 FSR with QC contact block

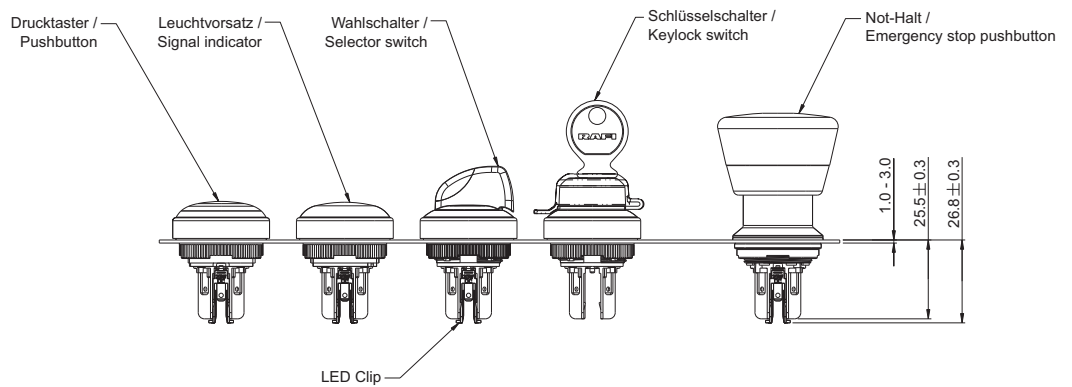



RAFIX 22 FSR Pushbuttons

→ The RAFIX 22 FSR pushbutton is equipped with a protective cap. The pushbutton is resistant to external impacts and offers a degree of protection to IP 65 and/or IP 69 k as per IEC 60529, which means protection against the ingress of water when highly pressurized water/steam jet cleaners are used at a pressure of 80 – 100 bar.

Preliminary technical data

Due to increasing application experience the specifications of this product are successively added. For current status, see RAFI online catalog at www.rafi.de.

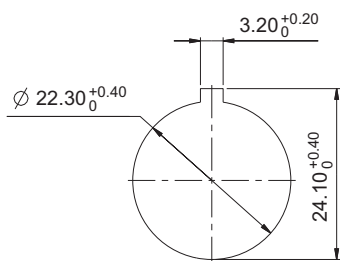
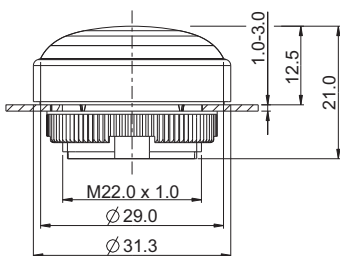

Panel cut-out to IEC 60947-5-1

Technical Data

→ General information

Form of lens	flush
Color of lens	see order block
Color of front ring	black
Form of collar	round

→ Dimensions

Dimensions of collar	Ø 31.3 mm
Overall height	12.2 mm
Mounting hole	22.3 mm
Key grid	35 x 35 mm

→ Mechanical design

Mounting	ring nut
Contact function	momentary
Illuminability	see order block
Torque for nut ring	1.2 Nm

→ Mechanical characteristics

Operating travel	4 mm
Robustness max.	100 N

→ Other specifications

Ambient temp. operating min.	-40 °C
Ambient temp. operating max.	+85 °C
Storage temperature min.	-40 °C
Storage temperature max.	+85 °C
Degree of protection from front side	IP65 (DIN EN 60529), IP69K (ISO 20653) water temp. 23 °C +/- 3 °C
Environmental resistance	acc. to IEC 60068-2-14, -30, -33 and -78
Salt spray	IEC 600 68-2-11
ROHS compliant	yes
REACH compliant	yes

Approvals



IEC 60947-5-x







UL 508



Accessories RAFIX 22 FSR - Pushbutton

→ Description	Photo	Order no.	Additional accessories see page
RAFIX 22 FS ⁺ - Contact block PCB silver, Universal, with light conductor		-	2 - 247
RAFIX 22 FS ⁺ - Contact block QC gold, Universal, with light conductor		-	2 - 253

– Table (continued) –
Accessories RAFIX 22 FSR - Pushbutton

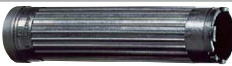
→ Description	Photo	Order no.	Additional accessories see page
RAFIX 22 FS ⁺ - Contact block QC silver, Universal, with light conductor		-	2 - 256
RAFIX FS - Contact block PCB gold, Universal		-	2 - 243
RAFIX FS - Contact block PCB gold, Universal, with light conductor		-	2 - 242
RAFIX FS - Contact block PCB silver, Universal		-	2 - 248
Fixing spanner for ring nut		5.05.800.062/0000	2 - 145, 2 - 261, 5 - 25

RAFIX 22 FSR Pushbutton

Technical data see page 2 - 206

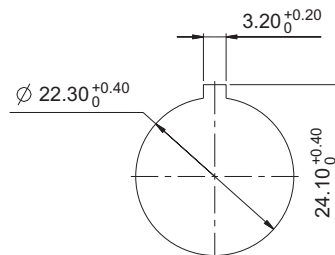
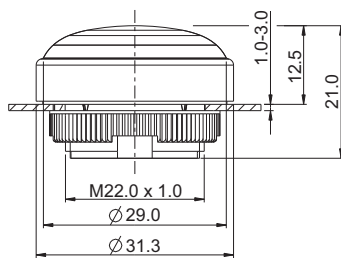

Panel cut-out to IEC 60947-5-1



→ Illuminability	Color of lens	Order no.
yes	translucent red	1.30.280.001/2301
yes	translucent yellow	1.30.280.001/2401
yes	translucent green	1.30.280.001/2501
yes	translucent blue	1.30.280.001/2601
yes	translucent white	1.30.280.001/2201
no	opaque black	1.30.280.001/0101

Legending and front rings in other colors on request

CONTROL COMPONENTS

RAFIX 22 FSR - ACTUATORS



NEW

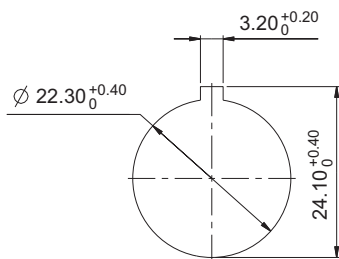
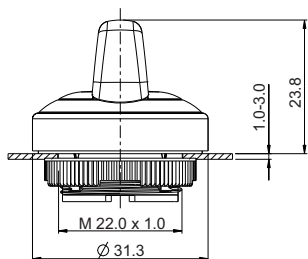

Panel cut-out to IEC 60947-5-1

Approvals



IEC 60947-5-x



UL 508



RAFIX 22 FSR Selector switches

→ The marks on the selector switch turning handle are translucent and can be illuminated if required. Colored LEDs or LED clips can be used for colored illuminations.

Preliminary technical data

Due to increasing application experience the specifications of this product are successively added. For current status, see RAFI online catalog at www.rafi.de.

Technical Data

→ General information

Actuator	handle
Marking of handle	see order block
Color of front ring	black
Form of collar	round

→ Dimensions

Dimensions of collar	Ø 31.3 mm
Overall height	23.8 mm
Mounting hole	22.3 mm
Key grid	35 x 35 mm

→ Mechanical design

Mounting	ring nut
Contact function	see order block
Illuminability	yes
Rotating angle	see order block
Torque for nut ring	1.2 Nm

→ Mechanical characteristics

Torque max.	2 Nm
-------------	------



→ Other specifications

Degree of protection from front side	IP65 (DIN EN 60529); IP69K (ISO 20653)
Ambient temp. operating min.	-40 °C
Ambient temp. operating max.	+85 °C
Storage temperature min.	-40 °C
Storage temperature max.	+85 °C
Environmental resistance	acc. to IEC 60068-2-14, -30, -33 and -78
Salt spray	IEC 600 68-2-11
ROHS compliant	yes
REACH compliant	yes

Accessories RAFIX 22 FSR - Selector switch

→ Description	Photo	Order no.	Additional accessories see page
RAFIX 22 FS ⁺ - Contact block PCB silver, Universal, with light conductor		-	2 - 247
RAFIX 22 FS ⁺ - Contact block QC gold, Universal, with light conductor		-	2 - 253
RAFIX 22 FS ⁺ - Contact block QC silver, Universal, with light conductor		-	2 - 256

– Table (continued) –
Accessories RAFIX 22 FSR - Selector switch

→ Description	Photo	Order no.	Additional accessories see page
RAFIX FS - Contact block PCB gold, Universal, with light conductor		-	2 - 242
Fixing spanner for ring nut		5.05.800.062/0000	2 - 145, 2 - 261, 5 - 25



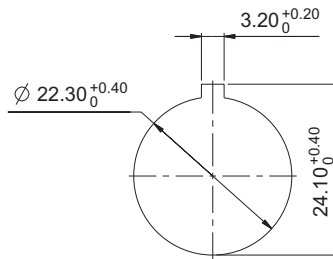
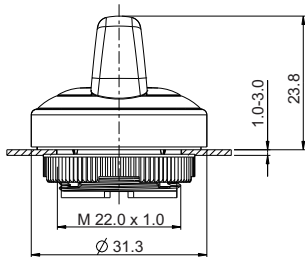

RAFIX 22 FSR Selector switch

Technical data see page 2 - 208



Panel cut-out to IEC 60947-5-1



→ Illuminability	Contact function	Rotating angle		Order no.
yes	momentary	1 x 40°		1.30.282.001/2201
yes	momentary	2 x 40°		1.30.282.026/2201
yes	latching	1 x 90°, L shape		1.30.282.101/2201
yes	latching	1 x 90°, V shape		1.30.282.201/2201
yes	latching	2 x 60°		1.30.282.301/2201



NEW

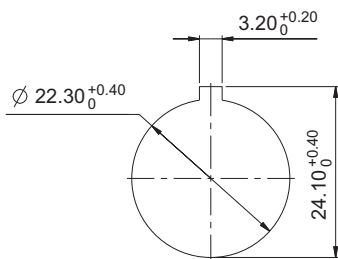
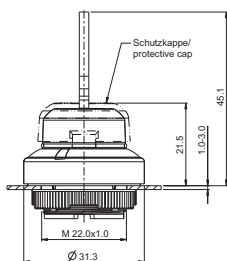

Panel cut-out to IEC 60947-5-1

Approvals



IEC 60947-5-x



UL 508



RAFIX 22 FSR Keylock switches

→ The RAFIX 22 FSR keylock switches are equipped with a plastic protective cap which protects against dirt, water and danger of icing when it is closed. Two keys respectively are included in the delivery. The locking systems we use were created according to DIN EN 1303 by leading lock manufacturers. They are open, mechanical systems that require occasional maintenance of the machinery or plant operator depending on environmental conditions.

Two keys are included.

Preliminary technical data

Due to increasing application experience the specifications of this product are successively added. For current status, see RAFI online catalog at www.rafi.de.

Technical Data

→ General information

Color of front ring	black
Form of collar	round

→ Dimensions

Dimensions of collar	Ø 31.3 mm
Overall height	45.1 mm
Mounting hole	22.3 mm
Key grid	35 x 35 mm

→ Mechanical design

Mounting	ring nut
Contact function	see order block
Illuminability	no
Wafers	5
Lock type	001
Main key	on request
Rotating angle	see order block
Key removal position	see order block
Torque for nut ring	1.2 Nm

→ Mechanical characteristics

Torque max.	1.3 Nm
-------------	--------

→ Other specifications

Degree of protection from front side	IP65 (DIN EN 60529); IP69K (ISO 20653)
water temp.	23 °C +/- 3 °C
Ambient temp. operating min.	-40 °C
Ambient temp. operating max.	+85 °C
Storage temperature min.	-40 °C
Storage temperature max.	+85 °C
Environmental resistance	acc. to IEC 60068-2-14, -30, -33 and -78
Salt spray	IEC 600 68-2-11
ROHS compliant	yes
REACH compliant	yes

Accessories RAFIX 22 FSR - Keylock switch

→ Description	Photo	Order no.	Additional accessories see page
RAFIX 22 FS ⁺ - Contact block QC gold, Universal, with light conductor		-	2 - 253
RAFIX 22 FS ⁺ - Contact block QC silver, Universal, with light conductor		-	2 - 256
RAFIX FS - Contact block PCB gold, Universal		-	2 - 243
RAFIX FS - Contact block PCB silver, Universal		-	2 - 248
Fixing spanner for ring nut		5.05.800.062/0000	2 - 145, 2 - 261, 5 - 25

RAFIX 22 FSR Keylock switch

Technical data see page 2 - 210

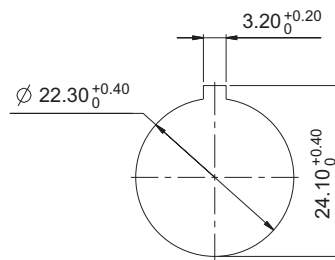
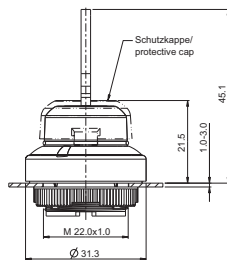

Panel cut-out to IEC 60947-5-1



NEW

→ Contact function	Rotating angle		Key removal position	Order no.
momentary	1 x 40°		0	1.30.285.001/0100
momentary	2 x 40°		0	1.30.285.101/0100
latching	1 x 90°, L shape		0+1	1.30.285.221/0100
latching	1 x 90°, V shape		0+1	1.30.285.321/0100

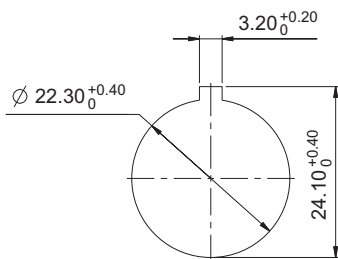
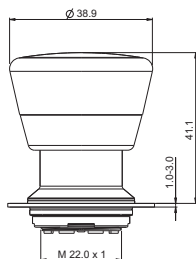

Panel cut-out to IEC 60947-5-1

Approvals



IEC 60947-5-x



UL 508



RAFIX 22 FSR Emergency stop pushbuttons

- The emergency stop pushbuttons comply with IEC 60 947, and VDE 0113 part 1. The positively guided mechanical movement of the pushbuttons makes them dupe-proof according to DIN EN ISO 13850. To prevent accidental actuation, the pushbutton has a pressure point which must be pressed first before the pushbutton snaps into place in the pressed position. The emergency stop pushbutton is non-blocking thanks to the actuator's design. For example, an initiated emergency stop procedure cannot be interrupted by jammed objects. Use only with an emergency stop contact block.

Original manual, see Appendix.

Preliminary technical data

Due to increasing application experience the specifications of this product are successively added. For current status, see RAFI online catalog at www.rafi.de.

Technical Data

→ General information

Form of lens	conical mushroom form
Color of lens	red
Form of collar	round

→ Dimensions

Mushroom Diameter	37.5 mm
Overall height	41.1 mm
Mounting hole	22.3 mm
Key grid	40 x 40 mm

→ Mechanical design

Mounting	Metal threaded rings
Contact function	latching
Reset	by pulling
Illuminability	see order block
Torque for nut ring	1.2 Nm

→ Mechanical characteristics

Robustness max.	100 N
	750 N static









→ Other specifications

Degree of protection from front side	IP65 (DIN EN 60529); IP69K (ISO 20653)
Ambient temp. operating min.	-40 °C
Ambient temp. operating max.	+85 °C
Storage temperature min.	-40 °C
Storage temperature max.	+85 °C
Environmental resistance	acc. to IEC 60068-2-14, -30, -33 and -78
Salt spray	IEC 600 68-2-11
ROHS compliant	yes
REACH compliant	yes

CONTROL COMPONENTS

RAFIX 22 FSR - ACTUATORS

Accessories RAFIX 22 FSR - Emergency stop pushbutton

→ Description	Photo	Order no.	Additional accessories see page
Emergency stop label, Ø 22.3 mm		-	2 - 82, 2 - 149, 2 - 264, 5 - 21
RAFIX FS - Contact block PCB gold, E-Stop		-	2 - 244
RAFIX FS - Contact block PCB gold, E-Stop, with light conductor		-	2 - 243
RAFIX FS - Contact block PCB silver, E-Stop		-	2 - 249
RAFIX FS - Contact block PCB silver, E-Stop, with light conductor		-	2 - 248
RAFIX FS - Contact block QC gold, E-Stop, with light conductor		-	2 - 253
RAFIX FS - Contact block QC silver, E-Stop, with light conductor		-	2 - 257
Protective Collar for emergency stop RAFIX 22 QR / RAFIX 22 FSR		5.00.456.002/0000	2 - 150
Fixing spanner for ring nut		5.05.800.062/0000	2 - 145, 2 - 261, 5 - 25

2

RAFIX 22 FSR Emergency stop pushbutton, metal mushroom



RAFIX
22 FSR

Technical data see page 2 - 212

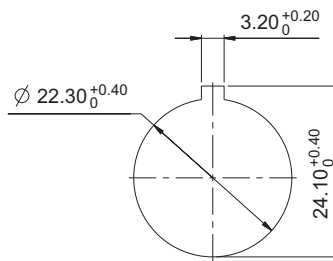
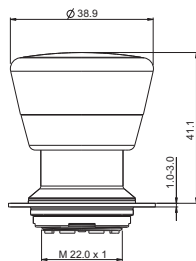

Panel cut-out to IEC 60947-5-1

→ Illuminability	Degree of protection from front side	Order no.
yes, window white	IP65 (DIN EN 60529); IP69K (ISO 20653)	1.30.283.111/0300
no	IP65 (DIN EN 60529); IP69K (ISO 20653)	1.30.283.611/0300

CONTROL COMPONENTS

RAFIX 22 FSR - ACTUATORS



RAFIX 22 FSR Emergency stop pushbutton, plastic mushroom

Technical data see page 2 - 212

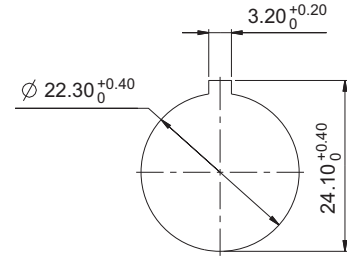
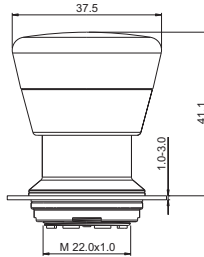

Panel cut-out to IEC 60947-5-1

2

→ Illuminability	Degree of protection from front side	Order no.
yes, window white	IP65 (DIN EN 60529); IP69K (ISO 20653)	1.30.283.101/0300
no	IP65 (DIN EN 60529); IP69K (ISO 20653)	1.30.283.601/0300

RAFIX
22 FSR

RAFIX 22 FSR Signal indicators

→ The RAFIX 22 FSR lenses are designed for illumination with SMT or THT LEDs. They guarantee full area illumination.

Preliminary technical data

Due to increasing application experience the specifications of this product are successively added. For current status, see RAFI online catalog at www.rafi.de.

Technical Data

→ General information

Color of lens	see order block
Form of collar	round

→ Dimensions

Mounting hole	22.3 mm
Key grid	35 x 35 mm

→ Mechanical design

Mounting	ring nut
Illuminability	yes

→ Other specifications

Degree of protection from front side	IP65 (DIN EN 60529); IP69K (ISO 20653)
Ambient temp. operating min.	-40 °C
Ambient temp. operating max.	+85 °C
Storage temperature min.	-40 °C
Storage temperature max.	+85 °C
Environmental resistance	acc. to IEC 60068-2-14, -30, -33 and -78
Salt spray	IEC 600 68-2-11
ROHS compliant	yes
REACH compliant	yes

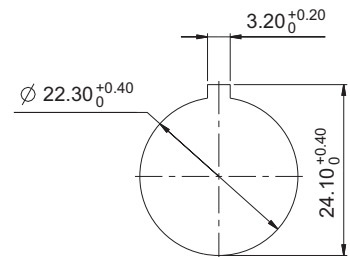
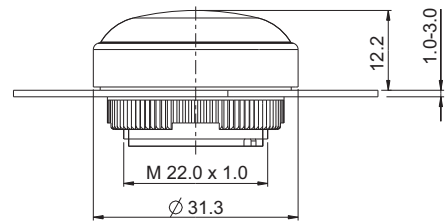

Panel cut-out to IEC 60947-5-1

Approvals



IEC 60947-5-x



UL 508 in preparation



RAFIX
22 FSR

Accessories RAFIX 22 FSR - Signal indicator

→ Description	Photo	Order no.	Additional accessories see page
LED 3 mm		-	-
LED base for 3 mm THT LED, used in signal indicators, for RAFIX FS PCB		-	2 - 263
QC LED base for signal indicators		-	2 - 261
Fixing spanner for ring nut		5.05.800.062/0000	2 - 145, 2 - 261, 5 - 25

CONTROL COMPONENTS

RAFIX 22 FSR - INDICATORS



RAFIX 22 FSR Signal indicator

Technical data see page 2 - 215

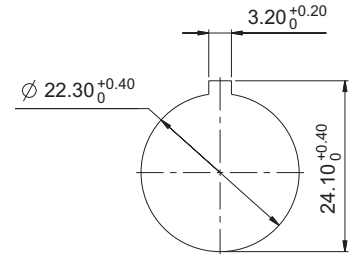
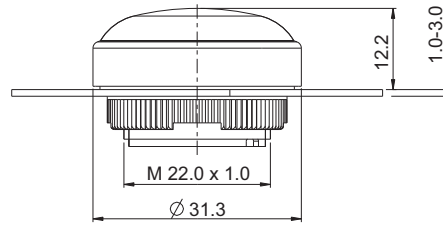

Panel cut-out to IEC 60947-5-1

2

→ Illuminability	Color of lens	Order no.
yes	translucent red	1.74.509.011/2300
yes	translucent yellow	1.74.509.011/2400
yes	translucent green	1.74.509.011/2500
yes	translucent blue	1.74.509.011/2600
yes	translucent white	1.74.509.011/2200

RAFIX
22 FSR



RAFIX 30 FS⁺

PERFECT DESIGN.

RAFIX 30 FS⁺ features all the benefits of the control component series RAFIX 22 FS⁺ plus extra flat lenses and a low overall height. On request, the push-buttons in this series can be individually equipped with SMD LEDs or a MICON 5 short-travel keyswitch for improved haptic perception. In short: the flat alternative for users with extremely high design standards.

CONTROL COMPONENTS

RAFIX 30 FS⁺

Content

RAFIX 30 FS⁺ Pushbuttons	2 - 221
RAFIX 30 FS ⁺ Pushbutton	2 - 222
RAFIX 30 FS⁺ Pushbuttons FLEXLAB	2 - 223
RAFIX 30 FS ⁺ Pushbutton FLEXLAB	2 - 225
RAFIX 30 FS⁺ Selector switches	2 - 226
RAFIX 30 FS ⁺ Selector switch	2 - 227
RAFIX 30 FS⁺ Keylock switches	2 - 228
RAFIX 30 FS ⁺ Keylock switch	2 - 229
RAFIX 30 FS⁺ Signal indicators	2 - 230
RAFIX 30 FS ⁺ Signal indicator	2 - 231
RAFIX 30 FS⁺ USB feedthroughs	2 - 232
RAFIX 30 FS ⁺ USB feedthrough	2 - 233

2

RAFIX
30 FS⁺

RAFIX 30 FS⁺

DESIGNED TO PERFECTION

RAFIX 30 FS⁺ stands out for all the benefits of the control component series RAFIX 22 FS⁺ plus extra flat lenses and a low overall height. On request, the pushbuttons in this series can be individually equipped with SMD LEDs or a MICON 5 tactile keyswitch for improved haptic perception. In short: The flat alternative for users with extremely high design standards.

SLIM

- Designs with PCB contact blocks feature a distance between the front panel and printed circuit board of only 15.8 mm.
- With QC contact blocks, only 33 mm of space is needed behind the front panel.

Combinable with all contact blocks and accessories with RAFIX FS technology

- PCB or QC contact blocks
- Gold contacts from 5 V or silver contacts up to 250 V
- Short-travel adapter enables short-travel actuation (1 mm switching travel) with perceptible key click
- Variable illumination, compatible with 3 mm THT LEDs / SMT LEDs or LED clip

The RAFIX 30 FS⁺ series has a variety of actuators and signal indicators

Pushbuttons

- Illuminable
- Optional FLEXLAB with exchangeable legend insert

Selector switches

- Rotating angle 40°, 60° or 90°
- Latching or momentary
- Illuminable

Keylock switches

- Rotating angle 40° or 90°
- Latching or momentary

Signal indicators

- Green, yellow, red, blue or white

USB grommet

- USB type A to USB type B
- With protective cap

Approvals

- IEC 60947-5-1/5
- UL
- CCC



2

Mounting hole

The actuators in the RAFIX 30 FS⁺ series are designed for 30.3 mm mounting holes.

All actuators are equipped with a locating pip. This locating pip ensures a perfect fit for actuators and contact blocks with PCB-mounted components and is therefore essential for designs including these contact blocks.

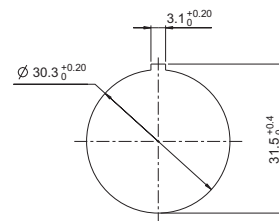

RAFIX 30 FS⁺

Grid spacing

The design principle makes it possible to use a minimum grid spacing of 35 mm x 35 mm. When choosing the grid spacing, it is recommended to consider any external legending required (for example, using label strips inserted into the front panel).



CONTROL COMPONENTS

RAFIX 30 FS⁺ CONTROL COMPONENTS

RAFIX 30 FS⁺

RAFIX 30 FS⁺ with PCB contact block

2

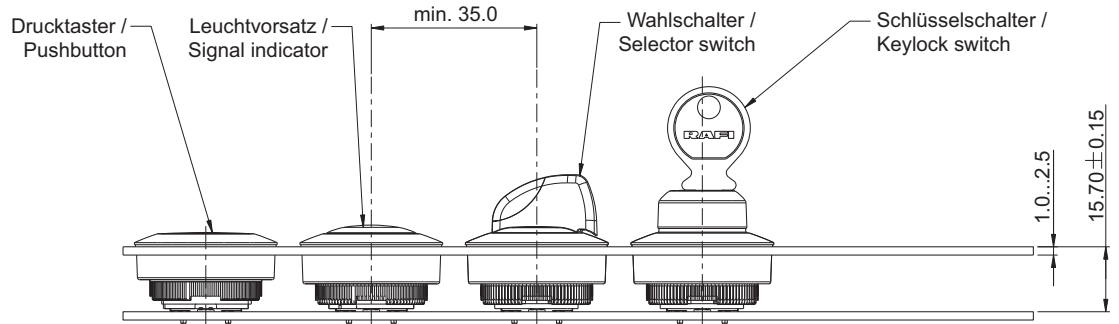

For printed circuit board hole patterns, see RAFIX 22 FS-Technology contact blocks

<p>Formula for spacer length</p> <p>15.8 mm</p> <p>- Front panel thickness</p> <hr/> <p>Length of spacer</p>
--

RAFIX 30 FS⁺ with QC contact block

RAFIX 30 FS⁺

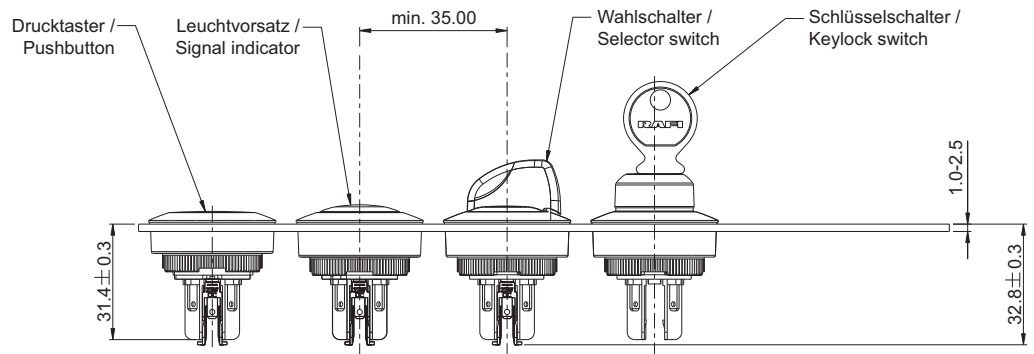

RAFIX 30 FS⁺ Pushbuttons

- The RAFIX 30 FS⁺ pushbuttons offer large actuating areas with a low overall height. They are available in different lens colors and with full area illumination. Legending on request.

Technical Data

→ General information

Form of lens	flush
Color of lens	see order block
Front ring	stainless steel
Form of collar	round

→ Dimensions

Dimensions of collar	∅ 34.5 mm
Overall height	3.45 mm
Mounting hole	30.3 mm
Key grid	min. 35 x 35 mm

→ Mechanical design

Mounting	threaded rings + adapters
Contact function	see order block
Illuminability	see order block
Torque for nut ring	1.2 Nm

→ Mechanical characteristics

Operating travel	4 mm
Robustness max.	100 N

→ Other specifications

Ambient temp. operating min.	-25 °C
Ambient temp. operating max.	+70 °C
Storage temperature min.	-40 °C
Storage temperature max.	+80 °C
Operating life	1,000,000 momentary / 500,000 latching
B10	1,300,000 momentary / 650,000 latching
Degree of protection from front side	IP65 (DIN EN 60529)
Environmental resistance	acc. to IEC 60068-2-14, -30, -33 and -78
Salt spray	IEC 600 68-2-11
ROHS compliant	yes
REACH compliant	yes



NEW

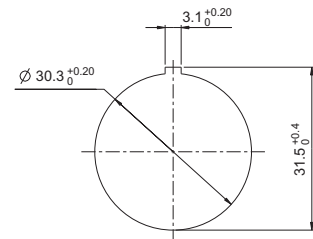
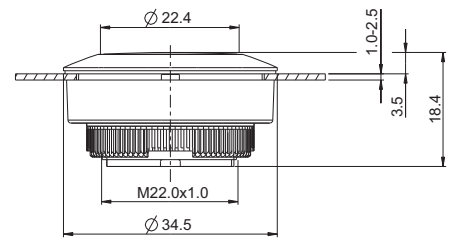

Approvals



IEC 60947-5-x



UL 508







Accessories RAFIX 30 FS⁺ - Pushbutton

Description	Photo	Order no.	Additional accessories see page
RAFIX 22 FS ⁺ - Contact block PCB silver, Universal, with light conductor		-	2 - 247
RAFIX 22 FS ⁺ - Contact block QC gold, Universal, with light conductor		-	2 - 253
RAFIX 22 FS ⁺ - Contact block QC silver, Universal, with light conductor		-	2 - 256
RAFIX FS - Contact block PCB gold, Universal		-	2 - 243

CONTROL COMPONENTS

RAFIX 30 FS⁺ - ACTUATORS

**- Table (continued) -
Accessories RAFIX 30 FS⁺ - Pushbutton**

→ Description	Photo	Order no.	Additional accessories see page
RAFIX FS - Contact block PCB gold, Universal, with light conductor		-	2 - 242
RAFIX FS - Contact block PCB silver, Universal		-	2 - 248
Fixing spanner for ring nut		5.05.800.062/0000	2 - 145, 2 - 261, 5 - 25
Retaining ring for front panel thickness 2.5 ... 4 mm		5.45.201.556/0700	2 - 266

2



RAFIX 30 FS⁺ Pushbutton

Technical data see page 2 - 221

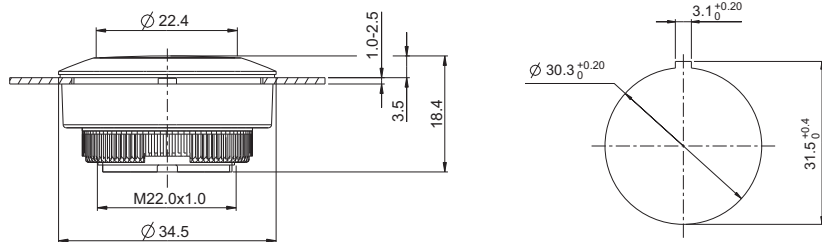

RAFIX
30 FS⁺

Color of lens	Illuminability	Order no.	
		Contact function momentary	Contact function latching
translucent red	yes	1.30.290.021/2300	1.30.290.031/2300
translucent yellow	yes	1.30.290.021/2400	1.30.290.031/2400
translucent green	yes	1.30.290.021/2500	1.30.290.031/2500
translucent blue	yes	1.30.290.021/2600	1.30.290.031/2600
translucent white	yes	1.30.290.021/2200	1.30.290.031/2200
opaque black	no	1.30.290.021/0100	1.30.290.031/0100

Legending on request.

RAFIX 30 FS⁺ Pushbuttons FLEXLAB

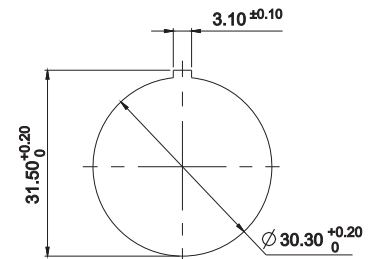
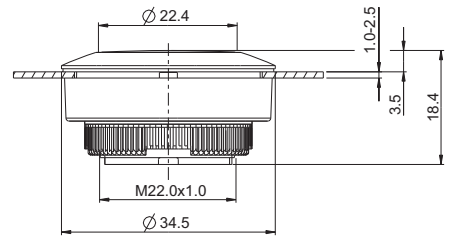
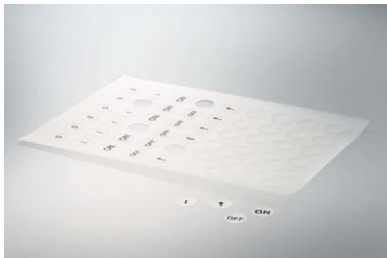

→ The RAFIX 30 FS⁺ FLEXLAB pushbutton allows individual control component labeling. A DIN A4 label sheet with pre-cut labels which fits in customary office laser printers is available for this option. After the legend inserts are printed, the labels can be detached from the sheet and inserted into the colored lens using the fine stop tabs.

Technical Data

→ General information

Form of lens	flush
Color of lens	see order block
Front ring	stainless steel
Form of collar	round

→ Dimensions

Dimensions of collar	Ø 34.5 mm
Overall height	3.45 mm
Mounting hole	30.3 mm
Key grid	min. 35 x 35 mm

→ Mechanical design

Mounting	threaded rings + adapters
Contact function	see order block
Illuminability	yes
Torque for nut ring	1.2 Nm

→ Mechanical characteristics

Operating travel	4 mm
Robustness max.	100 N

→ Other specifications

Ambient temp. operating min.	-25 °C
Ambient temp. operating max.	+70 °C
Storage temperature min.	-40 °C
Storage temperature max.	+80 °C
Operating life	1,000,000 momentary / 500,000 latching
B10	1,300,000 momentary / 650,000 latching
Degree of protection from front side	IP65 (DIN EN 60529)
Environmental resistance	acc. to IEC 60068-2-14, -30, -33 and -78
Salt spray	IEC 600 68-2-11
ROHS compliant	yes
REACH compliant	yes

Approvals



IEC 60947-5-x



UL 508



CONTROL COMPONENTS

RAFIX 30 FS⁺ - ACTUATORS

Accessories RAFIX 30 FS⁺ - FLEXLAB pushbutton

→ Description	Photo	Order no.	Additional accessories see page
RAFIX 22 FS ⁺ - Contact block PCB silver, Universal, with light conductor		-	2 - 247
RAFIX 22 FS ⁺ - Contact block QC gold, Universal, with light conductor		-	2 - 253
RAFIX 22 FS ⁺ - Contact block QC silver, Universal, with light conductor		-	2 - 256
RAFIX FS - Contact block PCB gold, Universal, with light conductor		-	2 - 242
Fixing spanner for ring nut		5.05.800.062/0000	2 - 145, 2 - 261, 5 - 25
Retaining ring for front panel thickness 2.5 ... 4 mm		5.45.201.556/0700	2 - 266

2

RAFI FLEXLAB

MONTAGEANLEITUNG | ASSEMBLY INSTRUCTIONS | 安装说明

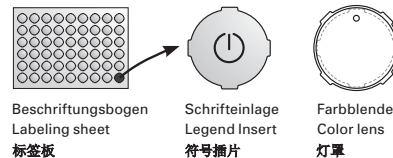

MONTAGE ASSEMBLY 安装

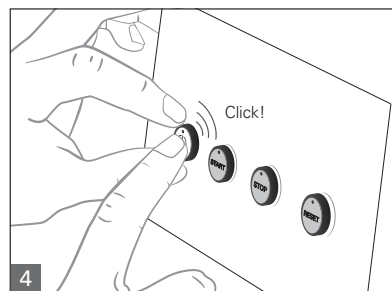
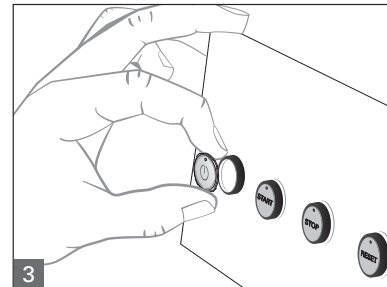
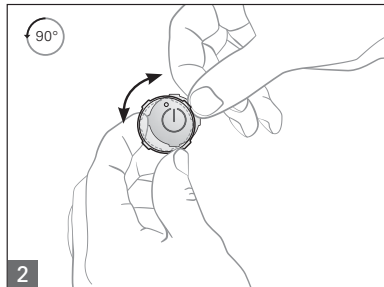
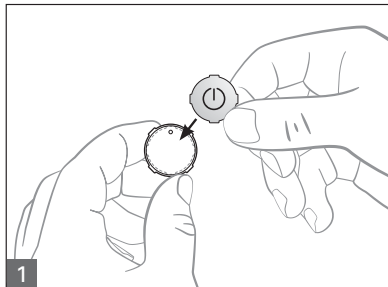

DEMONTAGE DISASSEMBLY 拆除

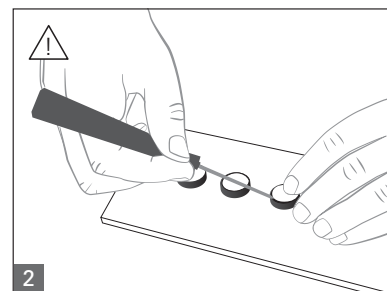
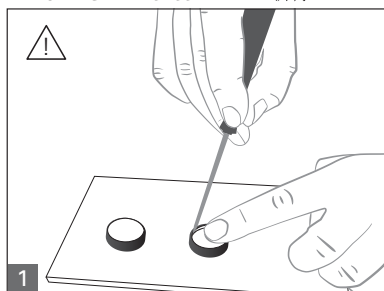

RAFIX 30 FS⁺

RAFIX 30 FS⁺ Pushbutton FLEXLAB

Technical data see page 2 - 223

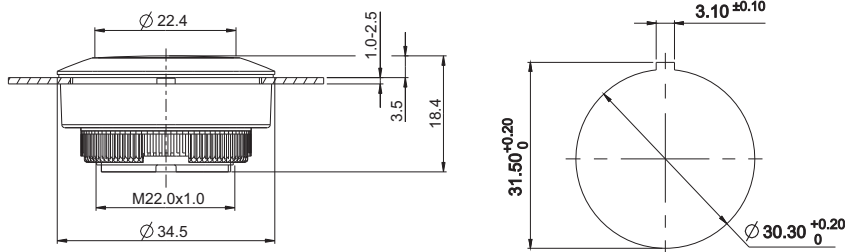

Form of collar

Order no.

Contact function
momentary

Contact function
latching

round

1.30.290.921/0000

1.30.290.931/0000

Accessoires:

- Colored lens for RAFIX FS⁺ Pushbuttons FLEXLAB, colorless: 5.49.263.062/1000
- Colored lens for RAFIX FS⁺ Pushbuttons FLEXLAB, red: 5.49.263.062/1300
- Colored lens for RAFIX FS⁺ Pushbuttons FLEXLAB, yellow: 5.49.263.062/1400
- Colored lens for RAFIX FS⁺ Pushbuttons FLEXLAB, green: 5.49.263.062/1500
- Colored lens for RAFIX FS⁺ Pushbuttons FLEXLAB, blue: 5.49.263.062/1600
- DIN A4 label sheet with 6x9 lenses in total utility: 5.70.800.200/0000

CONTROL COMPONENTS

RAFIX 30 FS⁺ - ACTUATORS



NEW

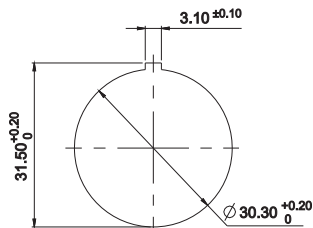
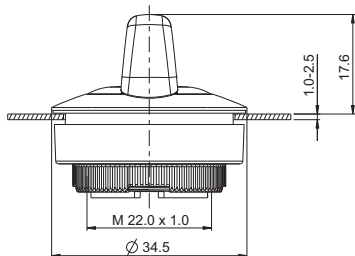

RAFIX 30 FS⁺ Selector switches

→ The marks on the selector switch turning handle are translucent and can be illuminated if required. Colored LEDs or LED clips can be used for colored illuminations.

Technical Data

→ General information

Actuator	handle
Marking of handle	translucent white
Front ring	stainless steel
Form of collar	round

→ Dimensions

Dimensions of collar	∅ 34.5 mm
Overall height	17.43 mm
Mounting hole	30.3 mm
Key grid	min. 35 x 35 mm

→ Mechanical design

Mounting	threaded rings + adapters
Contact function	see order block
Illuminability	yes
Rotating angle	see order block
Torque for nut ring	1.2 Nm

→ Mechanical characteristics

Torque max.	1.5 Nm
-------------	--------

→ Other specifications

Ambient temp. operating min.	-25 °C
Ambient temp. operating max.	+70 °C
Operating life (operations)	500,000 momentary / 300,000 latching
Operating life (operations)	650,000 momentary / 400,000 latching
Degree of protection from front side	IP65 (DIN EN 60529)
Storage temperature min.	-40 °C
Storage temperature max.	+80 °C
Environmental resistance	acc. to IEC 60068-2-14, -30, -33 and -78
Salt spray	IEC 600 68-2-11
ROHS compliant	yes
REACH compliant	yes

2

RAFIX
30 FS⁺

Approvals



IEC 60947-5-x



UL 508



Accessories RAFIX 30 FS⁺ - Selector switch

→ Description	Photo	Order no.	Additional accessories see page
RAFIX 22 FS ⁺ - Contact block PCB silver, Universal, with light conductor		-	2 - 247
RAFIX 22 FS ⁺ - Contact block QC gold, Universal, with light conductor		-	2 - 253
RAFIX 22 FS ⁺ - Contact block QC silver, Universal, with light conductor		-	2 - 256
RAFIX FS - Contact block PCB gold, Universal		-	2 - 243

– Table (continued) –
Accessories RAFIX 30 FS⁺ - Selector switch

→ Description	Photo	Order no.	Additional accessories see page
RAFIX FS - Contact block PCB gold, Universal, with light conductor		-	2 - 242
RAFIX FS - Contact block PCB silver, Universal		-	2 - 248
Fixing spanner for ring nut		5.05.800.062/0000	2 - 145, 2 - 261, 5 - 25
Retaining ring for front panel thickness 2.5 ... 4 mm		5.45.201.556/0700	2 - 266

RAFIX 30 FS⁺ Selector switch

Technical data see page 2 - 226

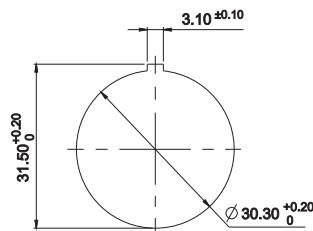
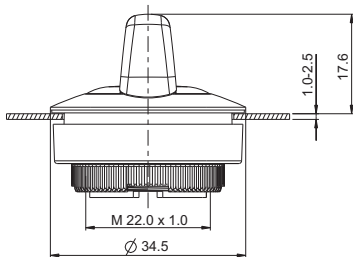

→ Illuminability	Contact function	Rotating angle		Order no.
yes	momentary	1 x 40°		1.30.292.002/2200
yes	momentary	2 x 40°		1.30.292.027/2200
yes	latching	1 x 90°, L shape		1.30.292.102/2200
yes	latching	1 x 90°, V shape		1.30.292.202/2200
yes	latching	2 x 60°		1.30.292.302/2200
yes	90° latching, 40° momentary	1 x 90° / 1 x 40°		1.30.292.427/2200

CONTROL COMPONENTS

RAFIX 30 FS⁺ - ACTUATORS



RAFIX 30 FS⁺ Keylock switches

→ The RAFIX 30 FS⁺ keylock switches feature an extremely compact design which is consistent with the overall concept of RAFIX 30 FS⁺. Two keys respectively are included in the delivery. Customer-specific closings are possible on request.

The locking systems we use were created according to DIN EN 1303 by leading lock manufacturers. They are open, mechanical systems that require occasional maintenance of the machinery or plant operator depending on environmental conditions.

2

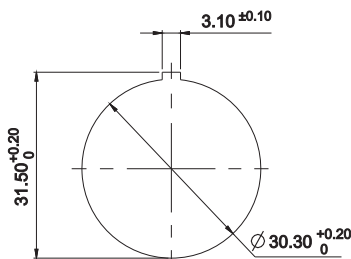
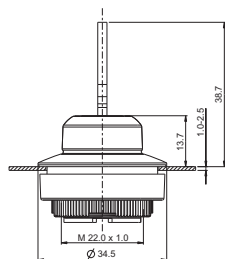

RAFIX
30 FS⁺

Technical Data

→ General information

Front ring	stainless steel
Form of collar	round

→ Dimensions

Dimensions of collar	∅ 34.5 mm
Overall height	38.70 mm
Mounting hole	30.3 mm
Key grid	min. 35 x 35 mm

→ Mechanical design

Mounting	threaded rings + adapters
Contact function	see order block
Illuminability	no
Wafers	5
Lock type	001
Main key	on request
Rotating angle	see order block
Key removal position	see order block
Torque for nut ring	1.2 Nm

→ Mechanical characteristics

Torque max.	1.3 Nm
-------------	--------

→ Other specifications

Ambient temp. operating min.	-25 °C
Ambient temp. operating max.	+70 °C
Operating life	300,000 momentary / 50,000 latching / 30,000 with key removal
B10	400,000 momentary / 65,000 latching / 40,000 with key removal
Degree of protection from front side	IP65 (DIN EN 60529)
Storage temperature min.	-40 °C
Storage temperature max.	+80 °C
Environmental resistance	acc. to IEC 60068-2-14, -30, -33 and -78
ESD-strength lock / contact	15 kV
ESD-strength key / front panel	15 kV
Salt spray	IEC 600 68-2-11
ROHS compliant	yes
REACH compliant	yes

Approvals



IEC 60947-5-x



UL 508



Accessories RAFIX 30 FS⁺ - Keylock switch

→ Description	Photo	Order no.	Additional accessories see page
RAFIX 22 FS ⁺ - Contact block QC gold, Universal, with light conductor		-	2 - 253
RAFIX 22 FS ⁺ - Contact block QC silver, Universal, with light conductor		-	2 - 256
RAFIX FS - Contact block PCB gold, Universal		-	2 - 243
RAFIX FS - Contact block PCB silver, Universal		-	2 - 248
Fixing spanner for ring nut		5.05.800.062/0000	2 - 145, 2 - 261, 5 - 25
Retaining ring for front panel thickness 2.5 ... 4 mm		5.45.201.556/0700	2 - 266
RAFIX FS - Protective cap for keylock switch		5.55.105.454/0111	2 - 267

RAFIX 30 FS⁺ Keylock switch

Technical data see page 2 - 228

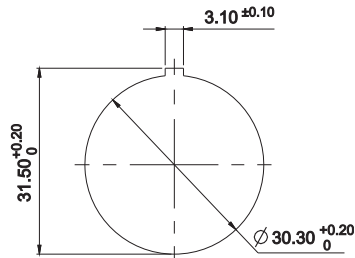
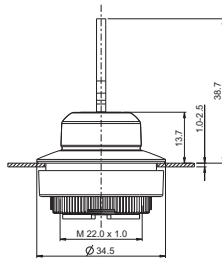

RAFIX
30 FS⁺

→ Contact function	Rotating angle	Key removal position	Order no.	
momentary	1 x 40°		0	1.30.295.002/0000
momentary	2 x 40°		0	1.30.295.102/0000
latching	1 x 90°, L shape		0+1	1.30.295.222/0000
latching	1 x 90°, V shape		0+1	1.30.295.322/0000

CONTROL COMPONENTS

RAFIX 30 FS⁺ - INDICATORS

2



NEW

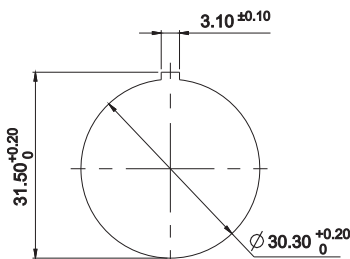
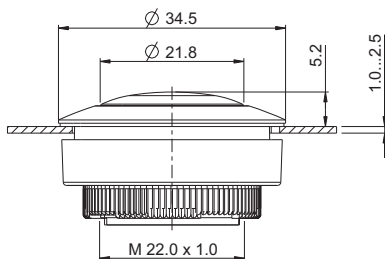

RAFIX 30 FS⁺

RAFIX 30 FS⁺ Signal indicators

Technical Data

→ General information

Form of lens	flush
Color of lens	see order block
Front ring	stainless steel
Form of collar	round

→ Dimensions

Dimensions of collar	∅ 34.5 mm
Overall height	5.25 mm
Mounting hole	30.3 mm
Key grid	min. 35 x 35 mm

→ Mechanical design

Mounting	threaded ring + adapter
Illuminability	yes
Torque for nut ring	1.2 Nm

→ Other specifications

Degree of protection from front side	IP65 (DIN EN 60529)
Ambient temp. operating min.	-25 °C
Ambient temp. operating max.	+70 °C
Storage temperature min.	-40 °C
Storage temperature max.	+80 °C
Environmental resistance	acc. to IEC 60068-2-14, -30, -33 and -78
Salt spray	IEC 600 68-2-11
ROHS compliant	yes
REACH compliant	yes

Approvals



IEC 60947-5-x



UL 508 in preparation



Accessories RAFIX 30 FS⁺ - Lens

→ Description

Description	Photo	Order no.	Additional accessories see page
LED 3 mm		-	-
LED base for 3 mm THT LED, used in signal indicators, for RAFIX FS PCB		-	2 - 263
QC LED base for signal indicators		-	2 - 261
Fixing spanner for ring nut		5.05.800.062/0000	2 - 145, 2 - 261, 5 - 25

– Table (continued) –
Accessories RAFIX 30 FS⁺ - Lens

→ Description	Photo	Order no.	Additional accessories see page
Retaining ring for front panel thickness 2.5 ... 4 mm		5.45.201.556/0700	2 - 266

RAFIX 30 FS⁺ Signal indicator

Technical data see page 2 - 230

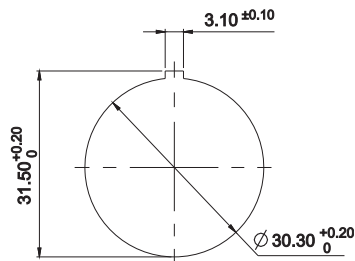
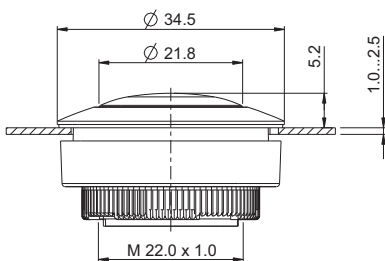

NEW

2

→ Illuminability	Color of lens	Order no.
yes	translucent red	1.74.510.011/2300
yes	translucent yellow	1.74.510.011/2400
yes	translucent green	1.74.510.011/2500
yes	translucent blue	1.74.510.011/2600
yes	translucent white	1.74.510.011/2200

RAFIX
30 FS⁺

CONTROL COMPONENTS

RAFIX 30 FS⁺ - ACCESSORIES



NEW

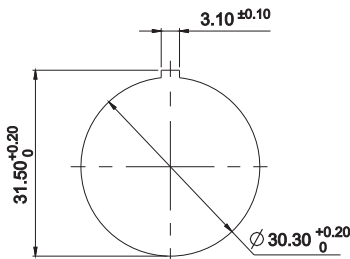
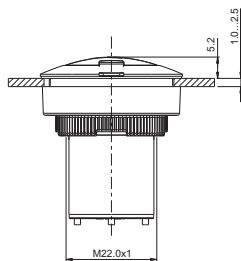

2

RAFIX
30 FS⁺

RAFIX 30 FS⁺ USB feedthroughs

→ The USB feedthrough ensures sturdy installation of an easily accessible USB slot in the front panels of controllers and IPCs. The port on the rear accommodates commercially available USB cables with B-type connectors. A sealing cap protects the slot and ensures a degree of protection to IP 65. For assembly, simply insert the feedthrough from the front side into the mounting hole and fasten it by means of a ring nut from the rear.

Technical Data

→ General information

Front ring	stainless steel
Form of collar	round

→ Dimensions

Dimensions of collar	ø 34.5 mm
Overall height	5.17 mm
Mounting depth	35.5
Mounting hole	30.3 mm
Key grid	min. 35 x 35 mm

→ Mechanical design

Mounting	threaded ring + adapter
Front connection	USB Type A
Rear connection	USB Type B
Torque for nut ring	1.2 Nm

→ Other specifications

Ambient temp. operating min.	-25 °C
Ambient temp. operating max.	+70 °C
Storage temperature min.	-40 °C
Storage temperature max.	+80 °C
Operating life	1500 operations
Degree of protection from front side	IP65 (DIN EN 60529) with closed sealing cap
Relative humidity	5 bis 95% (non condensed)
Shock resistance to IEC 60068-2-27 (EN 61131-2)	50 g at 11 ms half sine amplitude
Vibration resistance according to IEC 60068-2-6 (EN 61131-2)	5 g at 10...500 Hz
ROHS compliant	yes
REACH compliant	yes

Approvals



IEC 60947-5-x





UL 508



Accessories RAFIX 30 FS⁺ - USB feedthrough

→ Description

Description	Photo	Order no.	Additional accessories see page
Fixing spanner for ring nut		5.05.800.062/0000	2 - 145, 2 - 261, 5 - 25
Retaining ring for front panel thickness 2.5 ... 4 mm		5.45.201.556/0700	2 - 266

RAFIX 30 FS⁺ USB feedthrough

Technical data see page 2 - 232

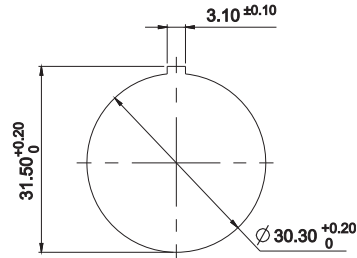
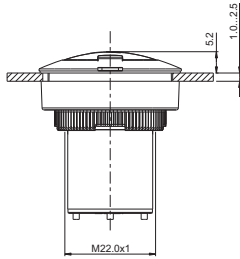

NEW

→ **Description**

Order no.

RAFIX 30 FS⁺ - USB feedthrough

1.30.299.021/0700

2

RAFIX
30 FS⁺



RAFIX FS Technology - Contact blocks

The contact blocks of the RAFIX FS technology are available as PCB version or as „QC“ (Quick Connect) version for direct connection. Both variants can be combined with the appropriate actuators of the following product families: RAFIX 22 FS⁺, RAFIX 22 FSR and RAFIX 30 FS⁺.

CONTROL COMPONENTS

RAFIX FS TECHNOLOGY - CONTACT BLOCKS

Content

RAFIX 22 FS Contact blocks PCB gold	2 - 241
RAFIX FS Contact block PCB gold, Universal, with light conductor	2 - 242
RAFIX FS Contact block PCB gold, Universal	2 - 243
RAFIX FS Contact block PCB gold, E-Stop, with light conductor	2 - 243
RAFIX FS Contact block PCB gold, E-Stop	2 - 244
RAFIX FS Contact block PCB gold, E-Stop, „Plus 1“	2 - 244
RAFIX 22 FS⁺ Contact blocks PCB silver	2 - 246
RAFIX 22 FS ⁺ Contact block PCB silver, Universal, with light conductor	2 - 247
RAFIX FS Contact block PCB silver, Universal	2 - 248
RAFIX 22 FS ⁺ Contact block PCB silver, E-Stop, with light conductor	2 - 248
RAFIX 22 FS ⁺ Contact block PCB silver, E-Stop	2 - 249
RAFIX 22 FS⁺ Contact blocks QC gold	2 - 252
RAFIX 22 FS ⁺ Contact block QC gold, Universal, with light conductor	2 - 253
RAFIX 22 FS ⁺ Contact block QC gold, E-Stop, with light conductor	2 - 253
RAFIX 22 FS ⁺ Contact block QC gold, E-Stop, „Plus 1“	2 - 254
RAFIX 22 FS⁺ Contact blocks QC silver	2 - 255
RAFIX 22 FS ⁺ Contact block QC silver, Universal, with light conductor	2 - 256
RAFIX 22 FS ⁺ Contact block QC silver, E-Stop, with light conductor	2 - 257
RAFIX FS Short-travel adapters	2 - 258
RAFIX FS Short-travel adapter	2 - 258

2

Contact
blocks

RAFIX FS Technology Contact Blocks

Combination with actuators

The RAFIX FS contact blocks can be combined with appropriate actuators from the following product families:

- RAFIX 22 FS⁺
- RAFIX 22 FSR
- RAFIX 30 FS⁺

PCB contact blocks



PCB contact blocks are arranged with other components on a common printed circuit board. The unit can then be attached behind the front panel with the actuators and signal indicators. This allows the contact blocks to "float" right below the actuators on the printed circuit board, leaving plenty of room for other components. In the

centre channel of the contact blocks, either light conductors are integrated to allow usage of SMT LEDs, or 3 mm THT LEDs can be mounted to provide illumination.

PCB mounting depths

- 9.2 mm for RAFIX 22 FS⁺ and RAFIX 22 FSR
- 15.7 mm for RAFIX 30 FS⁺

QC contact blocks



QC contact blocks can be easily snapped into the actuators without tools. Male quick-connect terminals are used directly for wiring in a conventional manner. This is a fast and efficient variant for applications where a printed circuit board is not cost-effective.

QC mounting depths

- 26.8 mm for RAFIX 22 FS⁺ and RAFIX 22 FSR
- 32.8 mm for RAFIX 30 FS⁺

Contact materials / data (PCB & QC)



The Au / Ag versions of the PCB and QC variants are distinguished by the colouring scheme of the housing:

- Gold contacts for low voltages up to 35 V / 100 mA: grey housing
- Silver contacts up to 250 V / 4 A: black housing

Contact assignments (PCB & QC)



The assignments are indicated with different plunger colours:

- Normally-closed contact (NC) = red
- Normally-open contact (NO) = green
- NC + NO for emergency stop = yellow

The following contact assignments are available:

- 1 normally-closed contact (1 NC)
- 1 normally-open contact (1 NO)
- 2 normally-closed contacts (2 NC)
- 2 normally-open contacts (2 NO)
- 1 normally-closed contact and 1 normally-open contact (1 NC + 1 NO)
- 2 normally-closed contacts and 1 normally-open contact (2 NC + 1 NO), only emergency stop "Plus 1"

Universal / emergency stop versions (PCB & QC)



The universal and emergency stop versions differ in terms of the position of the plungers:

- Universal = plunger outside
- Emergency stop = plunger inside

As a result, only the following combinations are possible:

- Universal contact blocks with pushbutton, selector switch and keylock switch
- Emergency stop contact blocks with emergency stop and mushroom pushbutton

Illumination / LED types (for PCB version only)



- Version with light conductor for SMT LED
- Version without light conductor for 3 mm THT LED

CONTROL COMPONENTS

RAFIX FS TECHNOLOGY - CONTACT BLOCKS

RAFIX 22 FS⁺ PCB



2

Dimensional drawing RAFIX 22 FS⁺, PCB

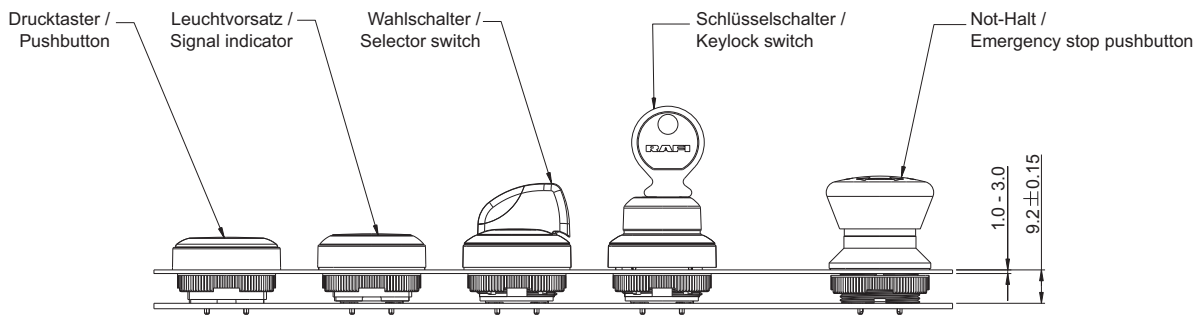

Dimensional drawing RAFIX 22 FSR, PCB

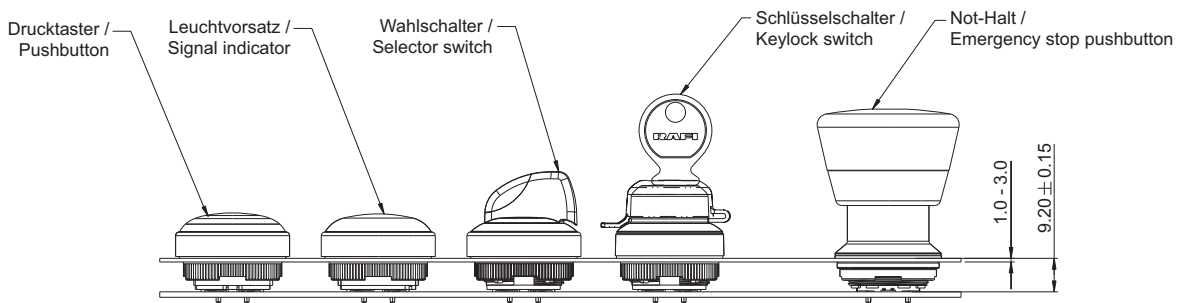

Contact blocks

Dimensional drawing RAFIX 30 FS⁺, PCB

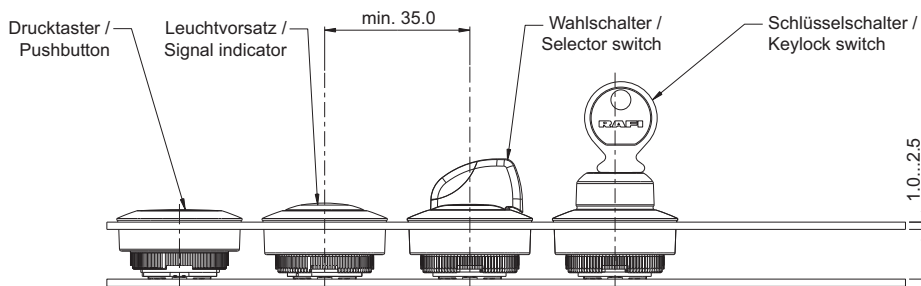

RAFIX 22 FS⁺ PCB

PCB hole pattern SMT LED View on component side

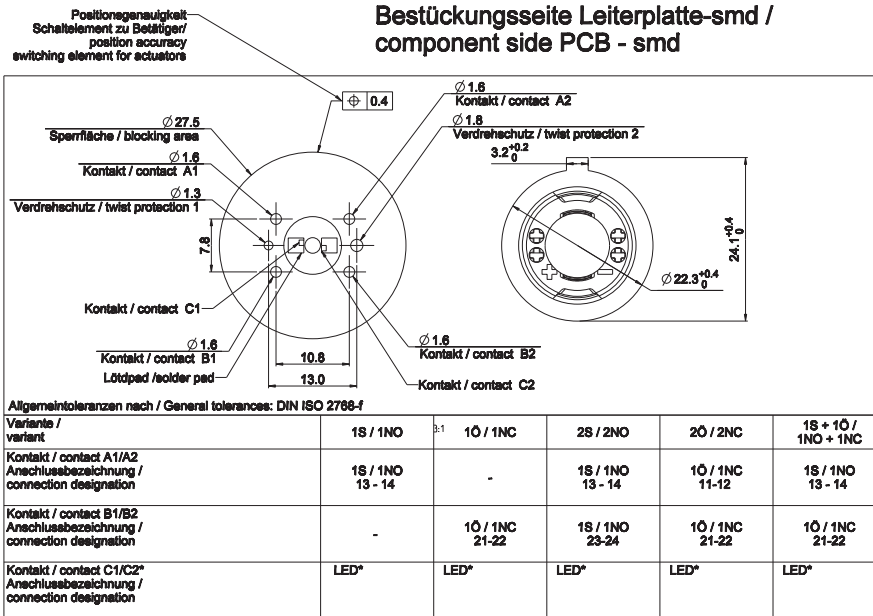

Die Schaltung der Kontakte erfolgt nach folgendem Schema: / The contact circuits are carried out according to the following scheme:

* LED Belegung bei Beleuchtung des Betätigers / LED pinning to illuminate an actuator

Betätiger mit 3 Schaltstellungen
Actuator with 3 switch positions

Betätiger mit 2 Schaltstellungen
Actuator with 2 switch positions

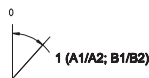
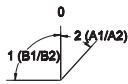

Solder pad design SMT LED View on component side

Empfohlenes Lötspaddesign

bei Verwendung pointLED OSRAM
Selektionsklasse: T1-U1

recommended solder pad
for using pointLED OSRAM
selectionclass: T1-U1

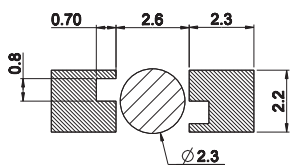

- Lötstopplack/Solder resist
- Kein Lötstopplack; kein Kupfer
No solder resist; no copper pad

Allgemeiner Bauraum / general space
LED Type 1206
max. Höhe: siehe Schaubild "x" /
max. high: view figure "x"

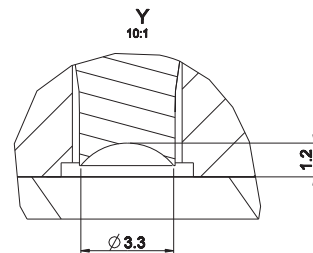

A-A

Y

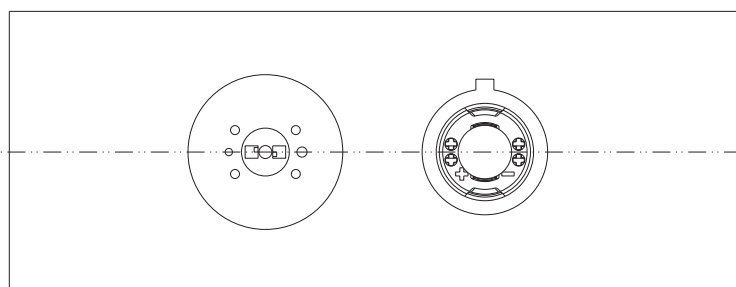

CONTROL COMPONENTS

RAFIX FS TECHNOLOGY - CONTACT BLOCKS

RAFIX 22 FS⁺ PCB, THT

PCB hole pattern THT LED

View on component side

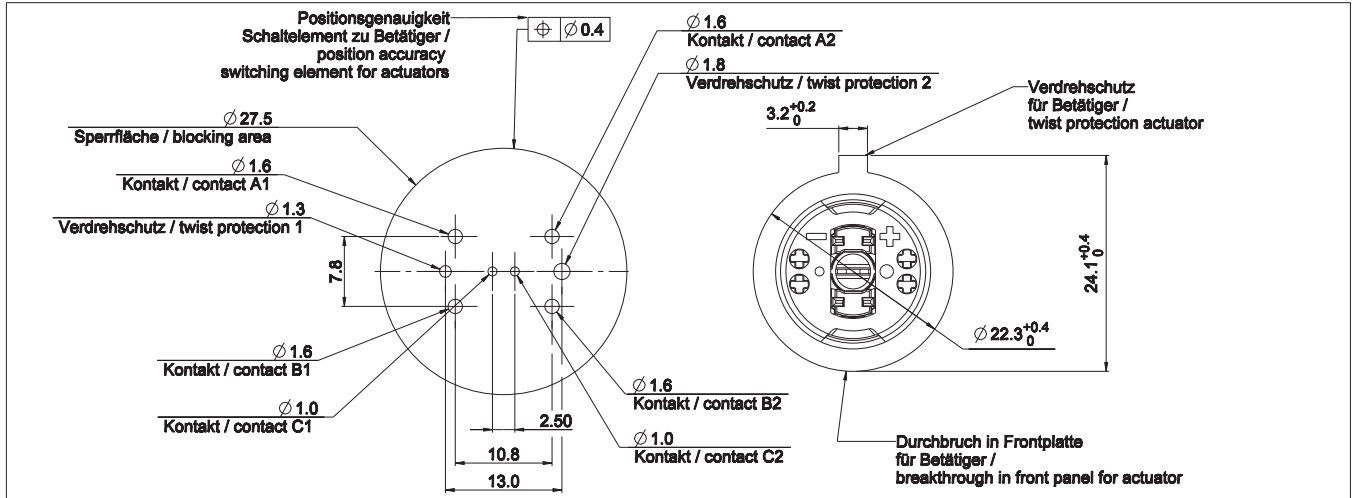

Allgemeintoleranzen nach / General tolerances: DIN ISO 2768-f

Variante/variant	1S / 1NO	1Ö / 1NC	2S / 2NO	2Ö / 2NC	1S + 1Ö / 1NO + 1NC	Plus 1
Kontakt/contact A1/A2 Anschlussbezeichnung/connection designation 1x	1S / 1NO 13 - 14	-	1S / 1NO 13 - 14	1Ö / 1NC 11-12	1S / 1NO 13 - 14	1Ö / 1NC 11-12
Kontakt/contact B1/B2 Anschlussbezeichnung/connection designation 2x	-	1Ö / 1NC 21-22	1S / 1NO 23-24	1Ö / 1NC 21-22	1Ö / 1NC 21-22	1Ö / 1NC 21-22
Kontakt/contact C1/C2 Anschlussbezeichnung/connection designation	LED* X1-X2	LED* X1-X2	LED* X1-X2	LED* X1-X2	LED* X1-X2	1S / 1NO 33-34
*:Nur bei Bedarf/only if required	13 14 X1 X2	X1 X2 21 22	13 14 X1 X2 23 24	11 12 X1 X2 21 22	13 14 X1 X2 21 22	11 12 33 34 X1 X2 21 22

Die Schaltung der Kontakte erfolgt nach folgendem Schema: /
The contact circuits are carried out according to the following scheme:

Betätiger mit 3 Schaltstellungen
Actuator with 3 switch positions

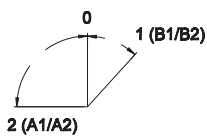

Betätiger mit 2 Schaltstellungen
Actuator with 2 switch positions

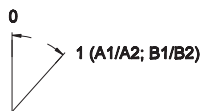

Contact blocks

RAFIX 22 FS Contact blocks PCB gold

→ Illumination information

The PCB contact blocks are included into the PCB layout and arranged next to other components. They are located directly behind the actuators at a distance of only 9.2 mm behind the front panel.

When actuators shall be illuminated there are 2 alternative LED technologies.

THT LEDs: Can be assembled and soldered together with the PCB contact blocks.

SMT LEDs: Can be pre-assembled and soldered with other SMT components. Then they are covered by the PCB contact blocks with light conductor.



Technical Data

→ General information

Lamp optional	see order block
---------------	-----------------

→ Mechanical design

Mounting	soldering in PCB
Contact system	bridge-contact self cleaning
Contact materials	Au
Contact arrangement	see order block
NC contact forcibly actuated acc. to IEC 60947-5-1	yes
Terminals	THT solder terminals with locating lug

→ Electrical characteristics

Operating voltage AC / DC min.	5 V
Operating voltage AC / DC max.	35 V
Operating current AC / DC min.	1 mA
Operating current AC / DC max.	100 mA
Rated power max.	250 mW

→ Other specifications

Operating life at 10 mA / 24 V DC	see order block
B10	see order block
Switching reliability at 24V / 5mA DC	10×10^{-6}
Ambient temp. operating max.	+85 °C
Ambient temp. operating min.	-40 °C
Storage temperature min.	-40 °C
Storage temperature max.	+85
Color of plunger	see order block
Robustness	acc. to IEC 60947-5-5 (TÜV)
Shock resistance acc. to IEC 60068-2-27	15 g at 11 ms, amplitude half sinusoidal
Resistance to vibrations acc. to IEC 60068-2-6	5 g at 10 ... 500 Hz
Environmental resistance	acc. to IEC 60068-2-14, -30, -33 and -78
Solderability / solder heat resistance	DIN EN 60068-2-20
Solder techniques	wave solder bath / manual soldering
Color of housing	grey
ROHS compliant	yes
REACH compliant	yes

Approvals



IEC 60947-5-x







UL 508

CONTROL COMPONENTS

RAFIX FS - CONTACT BLOCKS PCB GOLD

Accessories RAFIX 22 FS - Contact block PCB gold

→ Description	Photo	Order no.	Additional accessories see page
LED 3 mm		-	-
LED base for 3 mm THT LED, used in signal indicators, for RAFIX FS PCB		-	2 - 263
SMT LED		-	2 - 263
Spacers, round		-	2 - 265, 4 - 97, 5 - 32
Spacers, triangular		-	4 - 98, 5 - 33



RAFIX FS Contact block PCB gold, Universal, with light conductor

Technical data see page 2 - 241



Contact blocks

→ Contact arrangement	Lamp optional	Operating life at 10 mA / 24 V DC	B10	Color of plunger	Order no.
1 NO	SMT LED	1,000,000	1,300,000	green	1.20.126.002/9000
1 NC	SMT LED	1,000,000	1,300,000	red	1.20.126.001/9000
2 NO	SMT LED	1,000,000	1,300,000	green	1.20.126.005/9000
2 NC	SMT LED	1,000,000	1,300,000	red	1.20.126.004/9000
1 NC + 1 NO	SMT LED	1,000,000	1,300,000	red and green	1.20.126.003/9000

Caution: can not be used with emergency stop and mushroom headed pushbuttons.

RAFIX FS Contact block PCB gold, Universal

Technical data see page 2 - 241



→ Contact arrangement	Lamp optional	Operating life at 10 mA / 24 V DC	B10	Color of plunger	Order no.
1 NO	THT LED	1,000,000	1,300,000	green	1.20.126.002/0000
1 NC	THT LED	1,000,000	1,300,000	red	1.20.126.001/0000
2 NO	THT LED	1,000,000	1,300,000	green	1.20.126.005/0000
2 NC	THT LED	1,000,000	1,300,000	red	1.20.126.004/0000
1 NC + 1 NO	THT LED	1,000,000	1,300,000	red and green	1.20.126.003/0000

Caution: can not be used with emergency stop and mushroom headed pushbuttons.

RAFIX FS Contact block PCB gold, E-Stop, with light conductor

Technical data see page 2 - 241

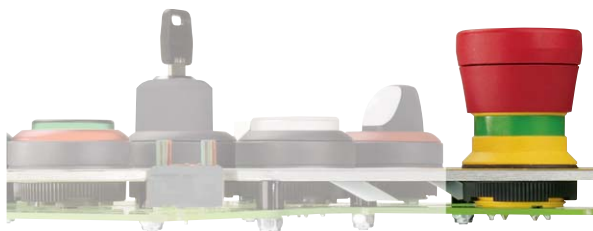

→ Contact arrangement	Lamp optional	Operating life at 10 mA / 24 V DC	B10	Color of plunger	Order no.
1 NO	SMT LED	1,000,000	1,300,000	green	1.20.126.402/9000
1 NC	SMT LED	1,000,000	1,300,000	red	1.20.126.401/9000
2 NO	SMT LED	1,000,000	1,300,000	green	1.20.126.405/9000
2 NC	SMT LED	1,000,000	1,300,000	red	1.20.126.404/9000
1 NC + 1 NO	SMT LED	1,000,000	1,300,000	yellow	1.20.126.403/9000

CONTROL COMPONENTS

RAFIX FS - CONTACT BLOCKS PCB GOLD

– Table (continued) –

RAFIX FS - Contact block PCB gold, E-Stop, with light conductor

Caution: E-stop contact blocks can only be used with emergency stop and mushroom headed pushbuttons.



RAFIX FS Contact block PCB gold, E-Stop

Technical data see page 2 - 241

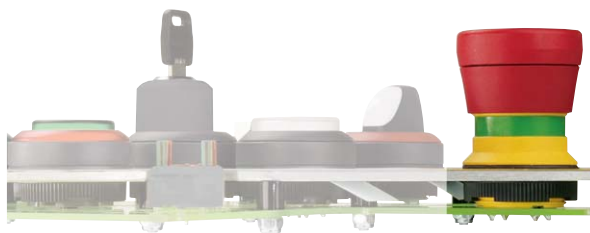

→ Contact arrangement	Lamp optional	Operating life at 10 mA / 24 V DC	B10	Color of plunger	Order no.
1 NO	THT LED	1,000,000	1,300,000	green	1.20.126.402/0000
1 NC	THT LED	1,000,000	1,300,000	red	1.20.126.401/0000
2 NO	THT LED	1,000,000	1,300,000	green	1.20.126.405/0000
2 NC	THT LED	1,000,000	1,300,000	red	1.20.126.404/0000
1 NC + 1 NO	THT LED	1,000,000	1,300,000	yellow	1.20.126.403/0000

Caution: E-stop contact blocks can only be used with emergency stop and mushroom headed pushbuttons.

Contact
blocks



RAFIX FS Contact block PCB gold, E-Stop, „Plus 1“

Technical data see page 2 - 241

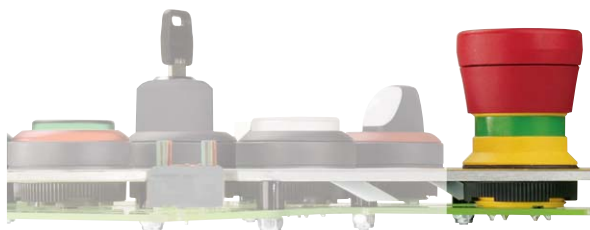

→ Contact arrangement	Lamp	Operating life at 10 mA / 24 V DC	B10	Color of plunger	Order no.
2 NC + 1 signal contact	-	50,000	65,000	red	1.20.126.414/0000

CONTROL COMPONENTS

RAFIX FS - CONTACT BLOCKS PCB GOLD

– Table (continued) –
RAFIX FS - Contact block PCB gold, E-Stop, „Plus 1“

Caution: E-stop contact blocks „Plus 1“ can only be used with emergency stop pushbuttons „Plus 1“.

2

Contact
blocks

CONTROL COMPONENTS

RAFIX FS - CONTACT BLOCKS PCB SILVER

RAFIX 22 FS⁺ Contact blocks PCB silver



2

Approvals



IEC 60947-5-x



UL 508



→ Illumination information

The PCB contact blocks are included into the PCB layout and arranged next to other components. They are located directly behind the actuators at a distance of only 9.2 mm behind the front panel.

When actuators shall be illuminated there are 2 alternative LED technologies.

THT LEDs: Can be assembled and soldered together with the PCB contact blocks.

SMT LEDs: Can be pre-assembled and soldered with other SMT components. Then they are covered by the PCB contact blocks with light conductor.

Technical Data

→ General information

Lamp optional	see order block
---------------	-----------------

→ Mechanical design

Mounting	soldering in PCB
Contact system	bridge-contact self cleaning
Contact materials	Ag
Contact arrangement	see order block
NC contact forcibly actuated acc. to IEC 60947-5-1	yes
Terminals	THT solder terminals with locating lug

→ Electrical characteristics acc. to IEC 60947,





AC-15, DC-13	
Rated insulation voltage AC / DC	250 V
Rated peak voltage	2500 V
Rated operating current I _E , AC15 B300	3 A / 120 V; 1.5 A / 240 V; I _{the} : 5 A
Rated operating current I _E , DC13 Q300	550 mA / 120 V; 270 mA / 240 V; I _{the} : 2.5 A
Max. fuse protection	microfuse 5 x 20 mm, 6.3 A, inert

→ Other specifications

Operating life at 250V / 1A	1,000,000
B10 at 250V / 1A	1,300,000
Operating life at 250V / 2A	100,000
B10 at 250V / 2A	130,000
Operating life at 250V / 4A	30,000
B10 at 250V / 4A	40,000
Switching reliability at 24V / 5mA DC	10 x 10 ⁻⁶
Ambient temp. operating max.	+85 °C
Ambient temp. operating min.	-40 °C
Storage temperature min.	-40 °C
Storage temperature max.	+85 °C
Color of plunger	see order block
Robustness	acc. to IEC 60947-5-5 (TÜV)
Shock resistance acc. to IEC 60068-2-27	50 g at 11 ms, amplitude half sinusoidal
Resistance to vibrations acc. to IEC 60068-2-6	5 g at 10 ... 500 Hz
Environmental resistance	acc. to IEC 60068-2-14, -30, -33 and -78
Solderability / solder heat resistance	DIN EN 60068-2-20
Solder techniques	wave solder bath / manual soldering
Flame class acc. to UL 94	V 0
Hot wire ignition acc. to IEC 60695-2-1	yes
Color of housing	black
ROHS compliant	yes
REACH compliant	yes

Contact
blocks

Accessories RAFIX 22 FS⁺ - Contact block PCB silver

→ Description	Photo	Order no.	Additional accessories see page
LED 3 mm		-	-
LED base for 3 mm THT LED, used in signal indicators, for RAFIX FS PCB		-	2 - 263
SMT LED		-	2 - 263
Spacers, round		-	2 - 265, 4 - 97, 5 - 32
Spacers, triangular		-	4 - 98, 5 - 33

RAFIX 22 FS⁺ Contact block PCB silver, Universal, with light conductor

Technical data see page 2 - 246



→ Contact arrangement	Lamp optional	Color of plunger	Order no.
1 NO	SMT LED	green	1.20.126.202/9000
1 NC	SMT LED	red	1.20.126.201/9000
2 NO	SMT LED	green	1.20.126.205/9000
2 NC	SMT LED	red	1.20.126.204/9000
1 NC + 1 NO	SMT LED	red and green	1.20.126.203/9000

Caution: can not be used with emergency stop and mushroom headed pushbuttons.

CONTROL COMPONENTS

RAFIX FS - CONTACT BLOCKS PCB SILVER



RAFIX FS Contact block PCB silver, Universal

Technical data see page 2 - 246



2

→ Contact arrangement	Lamp optional	Color of plunger	Order no.
1 NO	THT LED	green	1.20.126.202/0000
1 NC	THT LED	red	1.20.126.201/0000
2 NO	THT LED	green	1.20.126.205/0000
2 NC	THT LED	red	1.20.126.204/0000
1 NC + 1 NO	THT LED	red and green	1.20.126.203/0000

Contact
blocks



RAFIX 22 FS⁺ Contact block PCB silver, E-Stop, with light conductor

Technical data see page 2 - 246

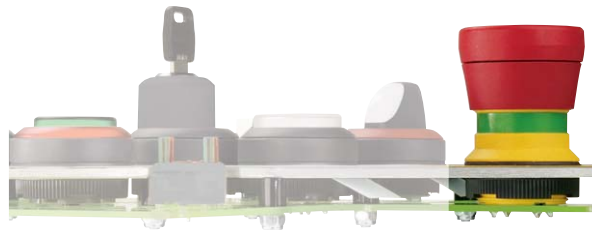

→ Contact arrangement	Lamp optional	Color of plunger	Order no.
1 NO	SMT LED	green	1.20.126.602/9000
1 NC	SMT LED	red	1.20.126.601/9000
2 NO	SMT LED	green	1.20.126.605/9000
2 NC	SMT LED	red	1.20.126.604/9000
1 NC + 1 NO	SMT LED	yellow	1.20.126.603/9000

RAFIX 22 FS⁺ Contact block PCB silver, E-Stop

Technical data see page 2 - 246

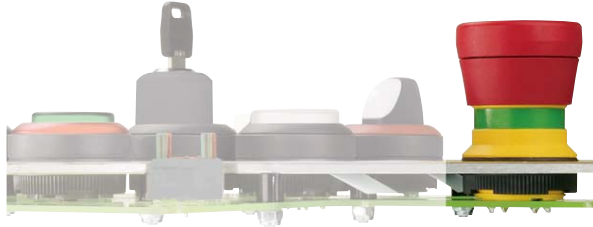

→ Contact arrangement	Lamp optional	Color of plunger	Order no.
1 NO	THT LED	green	1.20.126.602/0000
1 NC	THT LED	red	1.20.126.601/0000
2 NO	THT LED	green	1.20.126.605/0000
2 NC	THT LED	red	1.20.126.604/0000
1 NC + 1 NO	THT LED	yellow	1.20.126.603/0000

Caution: E-stop contact blocks can only be used with emergency stop and mushroom headed pushbuttons.

CONTROL COMPONENTS

RAFIX FS TECHNOLOGY - CONTACT BLOCKS

RAFIX 22 FS⁺ QC



2

Dimensional drawing RAFIX 22 FS⁺, QC

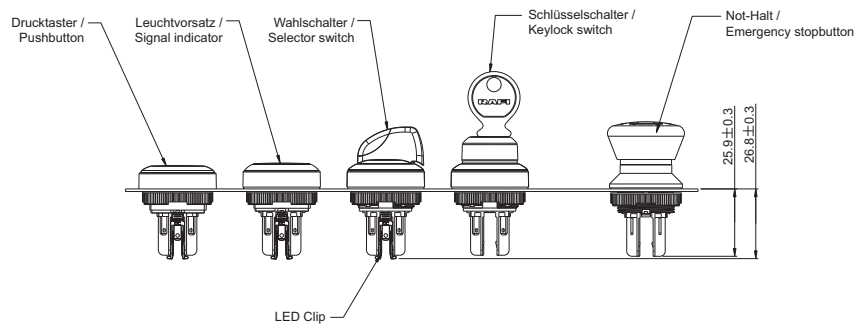

Dimensional drawing RAFIX 22 FSR, QC

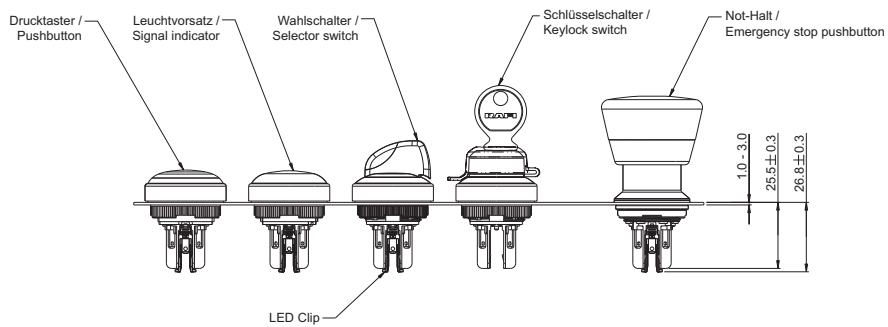

Dimensional drawing RAFIX 30 FS⁺, QC

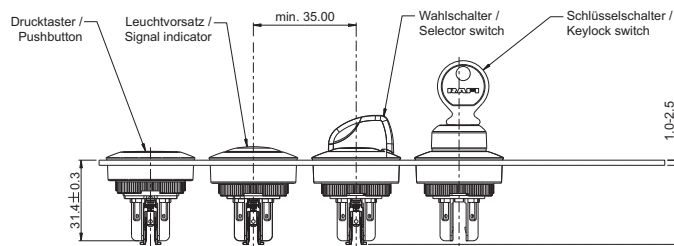

RAFIX 22 FS⁺ QC

Dimensional drawing with QC contact blocks

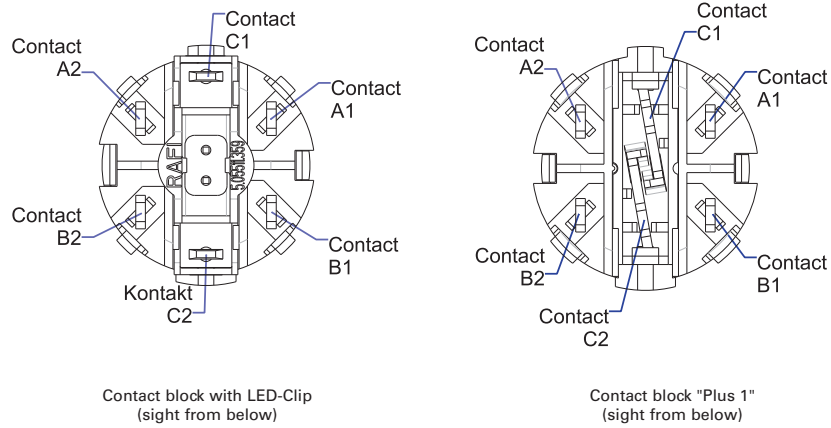

Contact arrangement	1NO	1NC	2NO	2NC	1NC + 1NO	Plus 1
Contact A1/A2 Terminal legending	1NO 13 - 14	-	1NO 13 - 14	1NC 11 - 12	1NO 13 - 14	1NC 11 - 12
Contact B1/B2 Terminal legending	-	1NC 21 - 22	1NO 23 - 24	1NC 21 - 22	1NC 21 - 22	1NC 21 - 22
Contact C1/C2 Terminal legending *:only when needed	LED* X1 - X2	LED* X1 - X2	LED* X1 - X2	LED* X1 - X2	LED* X1 - X2	1NO 33 - 34

Contact diagramm for selector and keylock switches

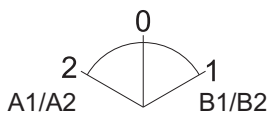

All actuators with 3 switch positions

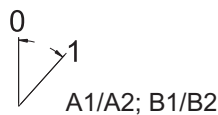

All actuators with 2 switch positions

CONTROL COMPONENTS

RAFIX FS - CONTACT BLOCKS QC GOLD

2



RAFIX 22 FS⁺ Contact blocks QC gold

→ The contact blocks are inserted into the actuators and latch there permanently. Emergency stop pushbuttons require special contact blocks which can be recognised by the plungers situated closer to the middle. In addition, the emergency stop contact blocks and actuators feature two assembly guides which prevent rotation during assembly. We recommend to choose the LED color in the same color as the lens of the actuator in order to ensure satisfactory illumination.

Approvals



IEC 60947-5-x



UL 508

Technical Data

→ General information

Lamp optional see order block

→ Mechanical design

Mounting snap on actuator
 Contact system bridge-contact self cleaning
 Contact materials Au
 Contact arrangement see order block
 NC contact forcibly actuated acc. to IEC 60947-5-1 yes
 Terminals quick connect terminals 2.8 x 0.5 mm mm

→ Electrical characteristics

Operating voltage min. 5 V
 Operating voltage max. 35 V
 Operating current min. 1 mA
 Operating current max. 100 mA
 Rated power max. 250 mW

→ Other specifications

Operating life at 10 mA / 24V DC see order block
 B10 see order block
 Switching reliability at 5mA / 24V DC 10×10^{-6}
 Ambient temp. operating min. -40 °C
 Storage temperature max. +85 °C
 Storage temperature min. -40 °C
 Storage temperature max. +85 °C
 Color of plunger see order block
 Robustness acc. to IEC 60947-5-5 (TÜV)
 Shock resistance acc. to IEC 60068-2-27 15 g at 11 ms, amplitude half sinusoidal
 Resistance to vibrations acc. to IEC 60068-2-6 5 g at 10 ... 500 Hz
 Environmental resistance acc. to IEC 60068-2-14, -30, -33 and -78
 Color of housing grey
 ROHS compliant yes
 REACH compliant yes

Accessories RAFIX 22 FS⁺ - Contact block QC gold

→ Description	Photo	Order no.	Additional accessories see page
LED base for contact blocks QC		-	2 - 262

Contact blocks

RAFIX 22 FS⁺ Contact block QC gold, Universal, with light conductor

Technical data see page 2 - 252



2

→ Contact arrangement	Lamp optional	Operating life at 10 mA / 24V DC	B10	Color of plunger	Order no.
1 NO	LED-Clip	1,000,000	1,300,000	green	1.20.126.102/9000
1 NC	LED-Clip	1,000,000	1,300,000	red	1.20.126.101/9000
2 NO	LED-Clip	1,000,000	1,300,000	green	1.20.126.105/9000
2 NC	LED-Clip	1,000,000	1,300,000	red	1.20.126.104/9000
1 NC + 1 NO	LED-Clip	1,000,000	1,300,000	red and green	1.20.126.103/9000

Caution: can not be used with emergency stop and mushroom headed pushbuttons.

RAFIX 22 FS⁺ Contact block QC gold, E-Stop, with light conductor

Technical data see page 2 - 252

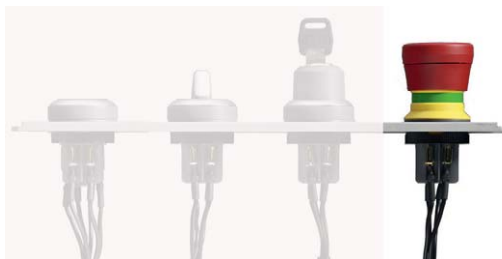

Contact
blocks

→ Contact arrangement	Lamp optional	Operating life at 10 mA / 24V DC	B10	Color of plunger	Order no.
1 NO	LED-Clip	1,000,000	1,300,000	green	1.20.126.502/9000
1 NC	LED-Clip	1,000,000	1,300,000	red	1.20.126.501/9000
2 NO	LED-Clip	1,000,000	1,300,000	green	1.20.126.505/9000
2 NC	LED-Clip	1,000,000	1,300,000	red	1.20.126.504/9000
1 NC + 1 NO	LED-Clip	1,000,000	1,300,000	yellow	1.20.126.503/9000

CONTROL COMPONENTS

RAFIX FS - CONTACT BLOCKS QC GOLD

– Table (continued) –

RAFIX 22 FS⁺ - Contact block QC gold, E-Stop, with light conductor

Caution: E-stop contact blocks can only be used with emergency stop and mushroom headed pushbuttons.



RAFIX 22 FS⁺ Contact block QC gold, E-Stop, „Plus 1“

Technical data see page 2 - 252

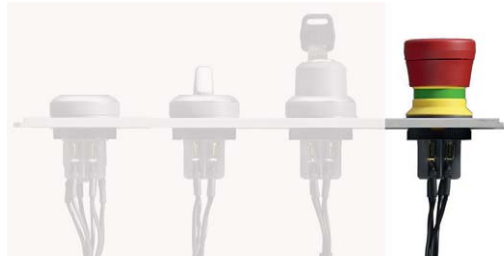

→ Contact arrangement	Lamp optional	Operating life at 10 mA / 24V DC	B10	Color of plunger	Order no.
2 NC + 1 NO	LED-Clip	50,000	65,000	red	1.20.126.514/0000

Caution: E-stop contact blocks „Plus 1“ can only be used with emergency stop pushbuttons „Plus 1“.

Contact
blocks

RAFIX 22 FS⁺ Contact blocks QC silver

→ The contact blocks are inserted into the actuators and latch there permanently. Emergency stop pushbuttons require special contact blocks which can be recognised by the plungers situated closer to the middle. In addition, the emergency stop contact blocks and actuators feature two assembly guides which prevent rotation during assembly. We recommend to choose the LED color in the same color as the lens of the actuator in order to ensure satisfactory illumination.



Technical Data

→ General information

Lamp optional	LED-Clip
---------------	----------

→ Mechanical design

Mounting	snap on actuator
Contact system	bridge-contact self cleaning
Contact materials	Ag
Contact arrangement	see order block
NC contact forcibly actuated acc. to IEC 60947-5-1	yes
Terminals	quick connect terminals 2.8 x 0.5 mm

→ Electrical characteristics acc. to IEC 60947, AC-15, DC-13

Rated insulation voltage AC / DC	250 V
Rated peak voltage	2500 V
Rated operating current I _E , AC15 B300	3 A / 120 V; 1.5 A / 240 V; I _{the} : 5 A
Rated operating current I _E , DC13 Q300	550 mA / 120 V; 270 mA / 240 V; I _{the} : 2.5 A
Max. fuse protection	microfuse 5 x 20 mm, 6.3 A, inert

→ Other specifications

Operating life at 250V / 1A	1,000,000
B10 at 250V / 1A	1,300,000
Operating life at 250V / 2A	100,000
B10 at 250V / 2A	130,000
Operating life at 250V / 4A	30,000
B10 at 250V / 4A	40,000
Switching reliability at 24V / 5mA DC	10 x 10 ⁻⁶
Ambient temp. operating max.	+85 °C
Ambient temp. operating min.	-40 °C
Storage temperature min.	-40 °C
Storage temperature max.	+85 °C
Color of plunger	see order block
Robustness	acc. to IEC 60947-5-5 (TÜV)
Shock resistance acc. to IEC 60068-2-27	15 g at 11 ms, amplitude half sinusoidal
Resistance to vibrations acc. to IEC 60068-2-6	5 g at 10 ... 500 Hz
Environmental resistance	acc. to IEC 60068-2-14, -30, -33 and -78
Flame class acc. to UL 94	V 0
Hot wire ignition acc. to IEC 60695-2-1	yes
Color of housing	black
ROHS compliant	yes
REACH compliant	yes

Approvals



IEC 60947-5-x



UL 508



CONTROL COMPONENTS

RAFIX FS - CONTACT BLOCKS QC SILVER

Accessories RAFIX 22 FS⁺ - Contact block QC silver

→ Description	Photo	Order no.	Additional accessories see page
Female quick-connect terminal DIN 46340-B 2.8-1-MS		-	2 - 76, 2 - 262, 5 - 27
LED base for contact blocks QC		-	2 - 262

2



RAFIX 22 FS⁺ Contact block QC silver, Universal, with light conductor

Technical data see page 2 - 255



→ Contact arrangement	Lamp optional	Color of plunger	Order no.
1 NO	LED-Clip	green	1.20.126.302/9000
1 NC	LED-Clip	red	1.20.126.301/9000
2 NO	LED-Clip	green	1.20.126.305/9000
2 NC	LED-Clip	red	1.20.126.304/9000
1 NC + 1 NO	LED-Clip	red and green	1.20.126.303/9000

Caution: can not be used with emergency stop and mushroom headed pushbuttons.

Contact blocks

RAFIX 22 FS⁺ Contact block QC silver, E-Stop, with light conductor

Technical data see page 2 - 255

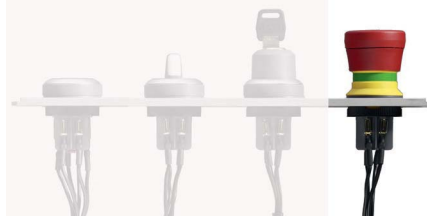

→ Contact arrangement	Lamp optional	Color of plunger	Order no.
1 NO	LED-Clip	green	1.20.126.702/9000
1 NC	LED-Clip	red	1.20.126.701/9000
2 NO	LED-Clip	green	1.20.126.705/9000
2 NC	LED-Clip	red	1.20.126.704/9000
1 NC + 1 NO	LED-Clip	yellow	1.20.126.703/9000

Caution: E-stop contact blocks can only be used with emergency stop and mushroom headed pushbuttons.

CONTROL COMPONENTS

RAFIX FS - SHORT-TRAVEL ADAPTER



NEW

2

RAFIX FS Short-travel adapters

→ The short-travel adapter can easily be inserted into a RAFIX 22 FS⁺ series and RAFIX 30 FS⁺ pushbutton. The tactile properties of the short-travel key-switch become noticeable when the pushbutton is pressed. In addition the small footprint of the MICON 5 enables the placement of diverse LEDs, allowing several light functions.

Technical Data

→ General information

Operating life	1.000.000 operations on MICON 5
	1.14.002.101/0000

→ Other specifications

ROHS compliant	yes
REACH compliant	yes

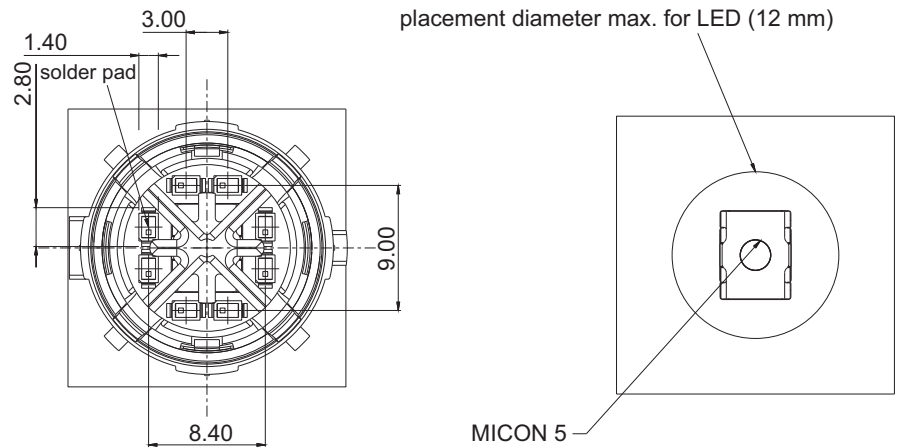

Contact blocks



RAFIX FS Short-travel adapter

→ Description

RAFIX FS - Short-travel adapter on MICON 5

Order no.

5.05.511.917/0000

CONTROL COMPONENTS

RAFIX FS TECHNOLOGY - SPECIAL ACCESSORIES

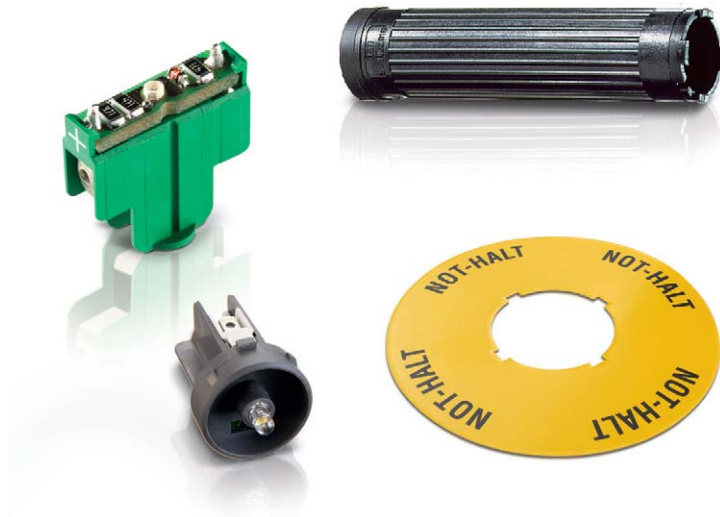

2

RAFIX FS Technology - Special accessories

Spec.
accessories

CONTROL COMPONENTS

RAFIX FS TECHNOLOGY - SPECIAL ACCESSORIES

Content

RAFIX FS Technology Special accessories	2 - 261
Fixing spanner for ring nut and front ring	2 - 261
QC LED base for signal indicators	2 - 261
Female quick-connect terminal DIN 46340-B 2.8-1-MS	2 - 262
LED base for contact blocks QC	2 - 262
SMT LED	2 - 263
LED base for 3 mm THT LED, used in signal indicators, for RAFIX FS PCB	2 - 263
THT LED 3 mm, without base	2 - 263
Emergency stop label, Ø 22.3 mm	2 - 264
Spacers, round	2 - 265
RAFIX 22 FS+ / RAFIX 22 FSR Protective Collar	2 - 265
RAFIX 22 FS Blanking cap, Ø 22.3 mm	2 - 266
Retaining ring for front panel thickness 2.5 ... 4 mm	2 - 266
RAFIX FS Protective cap for keylock switch	2 - 267

2

Spec.
accessories

RAFIX FS TECHNOLOGY Special accessories

2

Fixing spanner for ring nut and front ring



→ Description	Fitting for	Order no.
Fixing spanner for ring nut	RAFIX 22 QR/FS	5.05.800.062/0000

QC LED base for signal indicators



Spec.
accessories

→ Description	Order no.
RAFIX 22 FS ⁺ - Socket for LED-Clip, quick-connect terminals	5.05.511.855/9000

CONTROL COMPONENTS

RAFIX FS TECHNOLOGY - SPECIAL ACCESSORIES



Female quick-connect terminal DIN 46340-B 2.8-1-MS

→ Description	Order no.
Female quick-connect terminal DIN 46340-B 2.8-1-MS	5.37.540.024/8622

With latching detent for mating with a multipole connector.

2



LED base for contact blocks QC

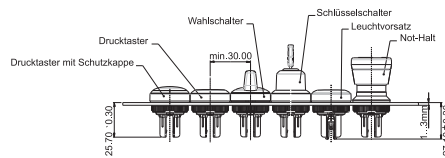

→ Voltage DC	Color	Order no.
12 V	red	5.05.511.747/0300
12 V	yellow	5.05.511.747/0400
12 V	green	5.05.511.747/0500
12 V	blue	5.05.511.747/0600
12 V	white	5.05.511.747/0200
24 V	red	5.05.511.747/1300
24 V	yellow	5.05.511.747/1400
24 V	green	5.05.511.747/1500
24 V	blue	5.05.511.747/1600
24 V	white	5.05.511.747/1200

Accessoires:

LED base for signal indicators: see page

Spec.
accessories

SMT LED



→ Description	Order no.
---------------	-----------

For the best illumination of actuators and signal indicators we suggest to use the following SMT LED type: OSRAM LT P4SG

LED base for 3 mm THT LED, used in signal indicators, for RAFIX FS PCB



→ Description	Order no.
LED base for signal indicators, height 5 mm	5.30.109.020/0756

THT LED 3 mm, without base



→ Color	Forward voltage typ. U_F at I_F	Max. current, I_F	Order no.
red	1.6 V / 1 mA	30 mA	1.90.690.228/0000
red	1.9 V / 20 mA	50 mA	1.90.690.269/0000
yellow	1.9 V / 20 mA	50 mA	1.90.690.267/0000
green	3.2 V / 20 mA	35 mA	1.90.690.684/0000
blue	3.6 V / 20 mA	30 mA	1.90.690.282/0000
white	3.6 V / 20 mA	30 mA	1.90.690.295/0000

CONTROL COMPONENTS

RAFIX FS TECHNOLOGY - SPECIAL ACCESSORIES

Emergency stop label, Ø 22.3 mm

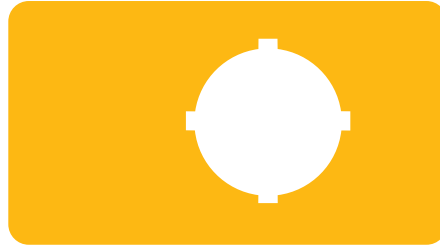

2

→ Dimensions	inside Ø	Label	Order no.
36 x 64 mm	22.3 mm	-	5.76.205.011/0400
Ø 40 mm	22.3 mm	„NOT-HALT, EMERGENCY STOP, ARRET D'URGENCE, EMERGENZA“	5.76.204.115/0400
Ø 40 mm	22.3 mm	4 x „NOT-AUS“	5.76.204.119/0400
Ø 40 mm	22.3 mm	4 x „NOT-HALT“	5.76.204.117/0400
Ø 40 mm	22.3 mm	4 x „EMERGENCY STOP“	5.76.204.121/0400
Ø 60 mm	22.3 mm	1 x „NOT-AUS“	5.76.204.101/0400
Ø 60 mm	22.3 mm	1 x „ARRET D'URGENCE“	5.76.204.102/0400
Ø 60 mm	22.3 mm	1 x „EMERGENCY STOP“	5.76.204.103/0400
Ø 60 mm	22.3 mm	„EMERGENCY-STOP / ARRET D'URGENCE“	5.76.207.002/0400
Ø 60 mm	22.3 mm	„NOT-HALT, EMERGENCY STOP, ARRET D'URGENCE, EMERGENZA“	5.76.204.107/0400
Ø 60 mm	22.3 mm	4 x „NOT-HALT“	5.76.204.109/0400
Ø 60 mm	22.3 mm	4 x „NOT-AUS“	5.76.204.111/0400
Ø 60 mm	22.3 mm	4 x „EMERGENCY STOP“	5.76.204.113/0400
Ø 60 mm	22.3 mm	1 x „NOT-AUS“	5.76.207.001/0400

Spec.
accessories

Spacers, round

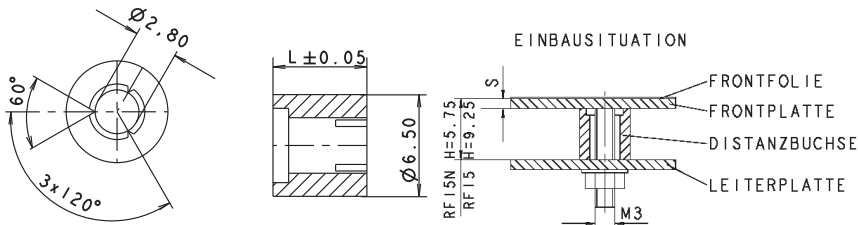

→ Length L	Color	Order no.
6.25 mm	red	5.30.759.034/0000
6.50 mm	blue transparent	5.30.759.035/0000
6.75 mm	black	5.30.759.036/0000
7 mm	yellow orange transparent	5.30.759.037/0000
7.25 mm	yellow	5.30.759.038/0000
7.50 mm	green	5.30.759.039/0000
7.75 mm	blue	5.30.759.040/0000
8 mm	red	5.30.759.041/0000
8.25 mm	blue transparent	5.30.759.042/0000

Required spacer length
 For keyboards: Overall height of key - front panel thickness - 0.5 mm (area embossing).
 For RAFIX 22 FS: 9.25 mm - front panel thickness - thickness of overlay, if existing

RAFIX 22 FS⁺ Protective Collar

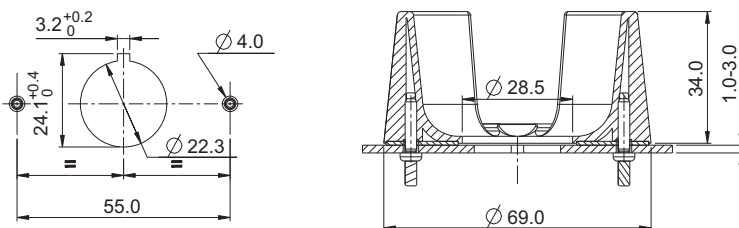

→ Description	Order no.
Protective Collar for emergency stop RAFIX 22 FS ⁺	5.00.456.001/0000

CONTROL COMPONENTS

RAFIX FS TECHNOLOGY - SPECIAL ACCESSORIES

**– Table (continued) –
RAFIX 22 FS+ Protective Collar**

RAFI protective collars protect the pushbuttons from unintentional operation and damage. Another great advantage is that they can be mounted directly on the front panel using two screws and without mechanical attachment to the actuator and/or emergency stop pushbutton. This provides for additional safety because lateral forces are not transferred to the actuator housing.

When using the protective collar, the preliminary contents of EN ISO 13850, chapter 4.3.9 and 4.5.1 have to be respected.

The protective collar is not allowed with RAFIX FSR Emergency stop pushbutton 1.30.283.xxx. The protective collar 5.00.456.002/0000 from RAFIX 22 QR should be used instead, see catalog page 2-150.

The protective collar must not be used with RAFIX 22 FS+ Emergency stop pushbutton compact 1.30.273.301/2200

2



RAFIX 22 QR Protective Collar

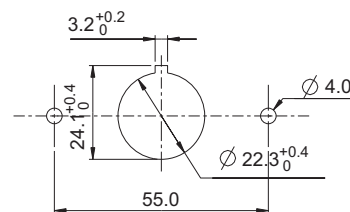
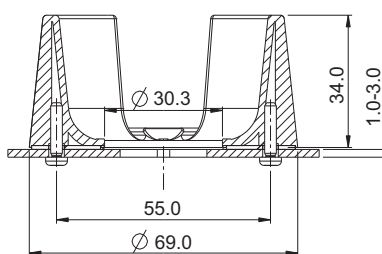

→ **Description**

Order no.

Protective Collar for emergency stop RAFIX 22 QR

5.00.456.002/0000

RAFI protective collars protect the pushbuttons from unintentional operation and damage. Another great advantage is that they can be mounted directly on the front panel using two screws and without mechanical attachment to the actuator and/or emergency stop pushbutton. This provides for additional safety because lateral forces are not transferred to the actuator housing.

When using the protective collar, the preliminary contents of EN ISO 13850, chapter 4.3.9 and 4.5.1 have to be respected.

Spec.
accessories

RAFIX 22 FS Blanking cap, Ø 22.3 mm



round, high version



square blanking cap

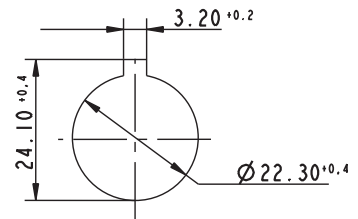

Panel cut-out to IEC 60947-5-1

→ Description	Form	Overall height	Order no.
Blanking cap IP65, ring nut, round, slate gery, flat	round	flush	5.05.800.067/0000
Blanking cap IP65, ring nut, round, high version, can be used for covering mounted PCB contact blocks.	round	high	5.05.200.025/0000
Blanking cap IP65, ring nut, square, slate grey, flat	square	flush	5.05.800.068/0000
Blanking cap IP65, ring nut, square, high version, can be used for covering mounted PCB contact blocks.	square	high	5.05.200.026/0000

Retaining ring for front panel thickness 2.5 ... 4 mm



→ Description	Order no.
Retaining ring for front panel thickness 2.5 ... 4 mm	5.45.201.556/0700

RAFIX FS Protective cap for keylock switch



→ Description	Order no.
RAFIX FS - Protective cap for keylock switch	5.55.105.454/0111



SIGNAL LAMPS

Signal lamps with integrated LED

Signal lamp with integrated LED - 5 mm, solder terminals	3 - 3
Signal lamp with integrated LED - 7 mm, solder terminals	3 - 5
Signal lamp with integrated LED - 9.1 mm, solder terminals	3 - 9
Signal lamp with integrated LED - 10 mm, quick-connect terminal	3 - 11
Signal lamp with integrated LED - 10 mm, quick-connect terminal	3 - 13
Signal lamp with integrated LED - 11.1 mm, solder terminals	3 - 16
Signal lamp with integrated LED - 16.2 mm, quick-connect terminal	3 - 18
Signal lamp with integrated LED - 16.2 mm, screw terminals	3 - 20
Signal lamp with integrated LED - 18,2 mm, quick-connect terminal	3 - 23
Signal lamp with integrated LED - 22.3 mm, screw terminals	3 - 25
Signal lamp with integrated LED - 30.5 mm, quick connector	3 - 27

Signal lamps with integrated lamp

Signal lamp with integrated neon lamp - 7 mm, solder terminals	3 - 31
Signal lamp with integrated neon lamp - 10 mm, quick-connect terminal	3 - 33
Signal lamp with integrated neon lamp - 10 mm, quick-connect terminal	3 - 35
Signal lamp with integrated neon lamp - 10 mm, quick-connect terminal	3 - 37
Signal lamp with integrated neon lamp - 14 mm, quick-connect terminal	3 - 40

SIGNAL LAMPS

GENERAL INFORMATION

Signal Lamps with integral lamps/LED

The soldered lamps/LED without base cannot be replaced.

Signal Lamps with lamp socket

An integral lamp socket allows replacement of lamps/LED of the appropriate type.

Filament operating life

Operating life specifications refer to AC voltage operation. If operated with DC voltage, these values are reduced by 40%.

Color and lenses

transparent = clear, grooved on inner surface for better light diffusion

opaque = **translucent**
but not clear

Standard mounting dimensions

We recommend use of mounting hole diameters 16, 22 and 30 mm, as these comply with international standard recommendations and DIN standards.

Limit values

The voltage specified as the limit value is the standard insulating voltage for the signal lamps. The permitted ambient temperatures are always specified in conjunction with the maximum power of the lamps used, and the signal lamp should be located outside of the space subject to increased temperature.

Neon lamps

Neon lamps may glow on a short time after having been switched off, for example in combination with long wires.

To avoid this, a parallel resistor with 1,2 M Ω 1/4 W, can be used.



Signal lamps

with integrated LED

Signal lamps with integral LED.
The mm specification in the product name indicates the appropriate mounting hole diameter of the signal lamps.

- All products are RoHS compliant.

SIGNAL LAMPS

SIGNAL LAMPS WITH INTEGRATED LED

Content

Signal lamps with integrated LED 5 mm	3 - 5
Signal lamp with integrated LED 5 mm, protruding LED	3 - 6
Signal lamp with integrated LED 5 mm, round protruding lens	3 - 6
Signal lamp with integrated LED 5 mm, round flush lens	3 - 7
Signal lamp with integrated LED 5 mm, triangular flush lens	3 - 7
Signal lamps with integrated LED 7.0 mm	3 - 9
Signal lamp with integrated LED 7.0 mm, round protruding lens	3 - 10
Signal lamps with integrated LED 9.1 mm	3 - 11
Signal lamp with integrated LED 9.1 mm, round flat lens	3 - 12
Signal lamp with integrated LED 9.1 mm, round protruding lens	3 - 12
Signal lamps with integrated LED 10 mm	3 - 13
Signal lamp with integrated LED 10 mm, protruding LED	3 - 14
Signal lamp with integrated LED 10 mm, round flat lens	3 - 15
Signal lamps with integrated LED 11.1 mm	3 - 16
Signal lamp with integrated LED 11.1 mm, round flat lens	3 - 17
Signal lamps with integrated LED 16.2 mm, quick-connect terminal	3 - 18
Signal lamp with integrated LED 16.2 mm, lens round protruding	3 - 19
Signal lamp with integrated LED 16.2 mm, lens round	3 - 19
Signal lamps with integrated LED 16.2 mm, screw terminals	3 - 20
Signal lamp with integrated LED 16.2 mm, lens round protruding	3 - 21
Signal lamp with integrated LED 16.2 mm, round lens	3 - 21
Signal lamp with integrated LED 16.2 mm, lens round high	3 - 22
Signal lamps with integrated LED 18,2 mm	3 - 23
Signal lamp with integrated LED 18,2 mm, lens round protruding, ring chrome	3 - 24
Signal lamps with integrated LED 22,3 mm	3 - 25
Signal lamp with integrated LED 22.3 mm, lens round	3 - 26
Signal lamp with integrated LED 22.3 mm, lens round flat	3 - 26
Signal lamps with integrated LED 30.5 mm	3 - 27
Signal lamp with integrated LED 30.5 mm, lens round	3 - 28
Signal lamp with integrated LED 30.5 mm, lens round flat	3 - 29
Signal lamp with integrated LED 30.5 mm, lens round high	3 - 30

3

integr.
LED

SIGNAL LAMPS WITH INTEGRATED LED 5 mm



Technical Data

→ General information

Form of lens	see order block
Color of lens	see order block
Diameter of collar	see order block

→ Dimensions

Length of collar	see order block
Overall height	see order block
Mounting depth	see order block
Mounting hole	5 mm

→ Mechanical design

Mounting	pressing into hole
Terminals	solder terminals
Lamp socket	no
Lamp	see order block

→ Electrical characteristics

Operating voltage U_B	see order block
Integrated current resistor	see order block
Forward voltage U_F at 25 °C	at 10 mA forward current 2.2 V
Reverse voltage U_R at 25 °C	3 V
Forward current, I_F at 25 °C	see order block
Reverse current I_R at 25 °C	100 μ A
Power dissipation P_{tot} at 25 °C	max. 120 mW

→ Other specifications

Degree of protection from front side	IP40 (DIN EN 60529)
Weight	0.35 g
ROHS compliant	yes
REACH compliant	yes

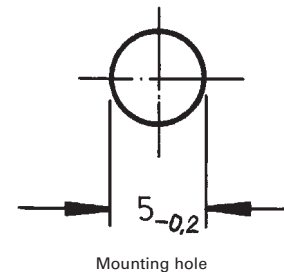

Operating voltage U_B : DC voltage from 5 to 28 V

A suitable series resistor is installed in the unit; versions without series resistor must be fitted with an external one.

External resistor: $R_V = (U_B - U_F) : I_F$

Recommended ratings of external resistors:

- for 5 - 7 V = 330 Ω 0.25 W
- for 12 - 16 V = 1.1 k Ω 0.25 W
- for 24 - 28 V = 2.4 k Ω 0.5 W

Signal lamp with integrated LED 5 mm, round flush lens

Technical data see page 3 - 5

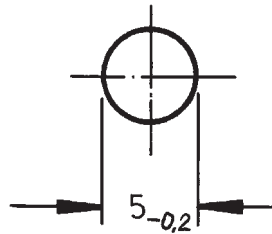
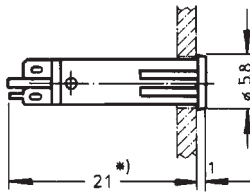

Mounting hole



→ Color of lens	Lamp	Integrated currency resistor	Operating voltage U_B	Forward current, I_F at 25 °C	Order no.
transparent red	LED red	yes	24 - 28 V	8 - 12 mA	1.69.508.864/1301
transparent red	LED super bright red	yes	24 - 28 V	8 - 12 mA	1.69.508.865/1300
transparent yellow	LED yellow	yes	24 - 28 V	8 - 12 mA	1.69.508.876/1402
transparent yellow	LED super bright yellow	yes	24 - 28 V	8 - 12 mA	1.69.508.877/1400
transparent green	LED green	yes	24 - 28 V	8 - 12 mA	1.69.508.870/1503

Long terminal is anode.

* Without series resistor, mounting depth = 18 mm

Signal lamp with integrated LED 5 mm, triangular flush lens

Technical data see page 3 - 5

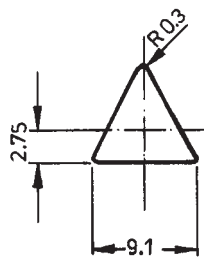
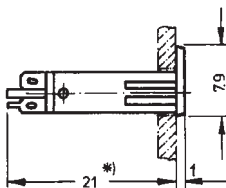

→ Color of lens	Lamp	Integrated currency resistor	Operating voltage U_B	Forward current, I_F at 25 °C	Order no.
transparent red	LED red	yes	24 - 28 V	8 - 12 mA	1.69.508.934/1301
transparent red	LED super bright red	yes	24 - 28 V	8 - 12 mA	1.69.508.935/1300
transparent yellow	LED yellow	yes	24 - 28 V	8 - 12 mA	1.69.508.946/1402
transparent yellow	LED super bright yellow	yes	24 - 28 V	8 - 12 mA	1.69.508.947/1400
transparent green	LED green	yes	24 - 28 V	8 - 12 mA	1.69.508.940/1503

SIGNAL LAMPS

SIGNAL LAMPS WITH INTEGRATED LED - 5 MM, SOLDER TERMINALS

– Table (continued) –

Signal lamps with integrated LED - 5 mm, triangular flush lens

Long terminal is anode.

* Without series resistor, mounting depth = 18 mm

3

integr.
LED

SIGNAL LAMPS WITH INTEGRATED LED 7.0 mm

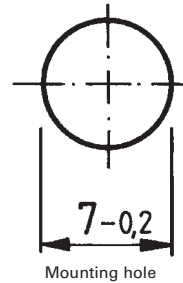

Technical Data

→ General information

Form of lens	round protruding
Color of lens	see order block
Diameter of collar	8.5 mm

→ Dimensions

Overall height	5 mm
Mounting depth	27.5 mm
Mounting hole	7.0 mm

→ Mechanical design

Mounting	pressing into hole
Terminals	solder terminals
Lamp socket	no
Lamp	see order block

→ Electrical characteristics

Operating voltage U_B	24 - 28 V
Forward voltage U_F at 25 °C	at 20 mA forward current 2.4 V
Reverse current I_R at 25 °C	3 V
Forward current, I_F	max. 20 mA
Reverse current I_R at 25 °C	100 μ A
Power dissipation P_{tot} at 25 °C	max. 120 mW
Light intensity	see order block

→ Other specifications

Degree of protection from front side	IP40 (DIN EN 60529)
ROHS compliant	yes
REACH compliant	yes

SIGNAL LAMPS

SIGNAL LAMPS WITH INTEGRATED LED - 7 MM, SOLDER TERMINALS



Signal lamp with integrated LED 7.0 mm, round protruding lens

Technical data see page 3 - 9

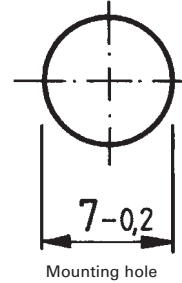
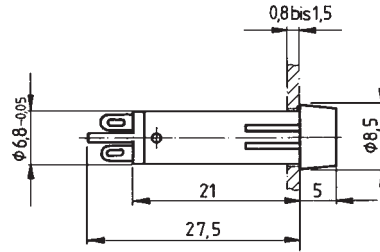

Mounting hole

→ Color of lens	Lamp	Operating voltage U_B	Forward current, I_F	Light intensity	Order no.
transparent red	LED red	24 - 28 V	max. 20 mA	200 mcd	1.69.511.102/1300
transparent yellow	LED yellow	24 - 28 V	max. 20 mA	200 mcd	1.69.511.103/1400
transparent green	LED green	24 - 28 V	max. 20 mA	1000 mcd	1.69.511.104/1500
transparent blue	LED blue	24 - 28 V	max. 20 mA	300 mcd	1.69.511.105/1600
transparent colorless	LED white	24 - 28 V	max. 20 mA	400 mcd	1.69.511.101/1000

3

integr.
LED

SIGNAL LAMPS WITH INTEGRATED LED 9.1 mm



Technical Data

→ General information

Form of lens	round protruding
Color of lens	see order block
Diameter of collar	11 mm

→ Dimensions

Overall height	see order block
Mounting depth	30.5 mm
Mounting hole	9.1 mm

→ Mechanical design

Mounting	ring nut
Terminals	solder terminals
Lamp socket	T 4.6
Lamp	LED

→ Electrical characteristics

Operating voltage U_B	24 - 28 V
Input current I_{cc} type.	15 mA

→ Other specifications

Degree of protection from front side	IP40 (DIN EN 60529)
Weight	2 g
ROHS compliant	yes
REACH compliant	yes

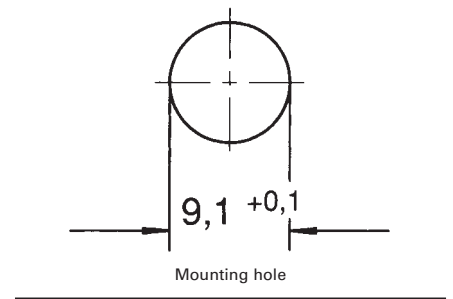

3

integr.
LED

Accessories Signal lamps with integrated LED - 9.1 mm

→ Description	Photo	Order no.	Additional accessories see page
Fixing spanner M 9, M 10		5.58.002.025/0105	5 - 25

SIGNAL LAMPS

SIGNAL LAMPS WITH INTEGRATED LED - 9.1 MM, SOLDER TERMINALS



Signal lamp with integrated LED 9.1 mm, round flat lens

Technical data see page 3 - 11

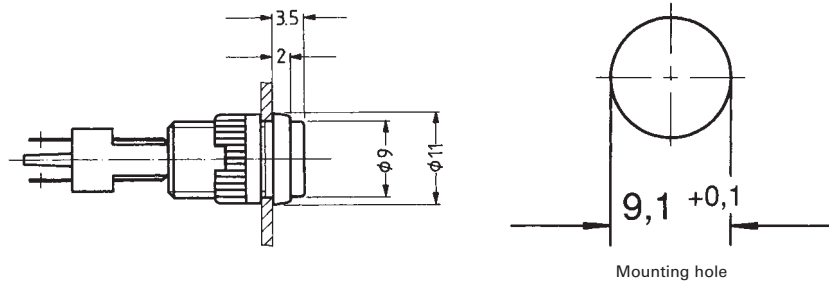

→ Color of lens	Lamp	Operating voltage U_B	Order no.
translucent red	LED	24 - 28 V	1.02.157.201/1300
translucent yellow	LED	24 - 28 V	1.02.157.201/1400
translucent green	LED	24 - 28 V	1.02.157.201/1500
translucent white	LED	24 - 28 V	1.02.157.201/1000

3

With integrated series resistor. Other voltages on request.



Signal lamp with integrated LED 9.1 mm, round protruding lens

Technical data see page 3 - 11

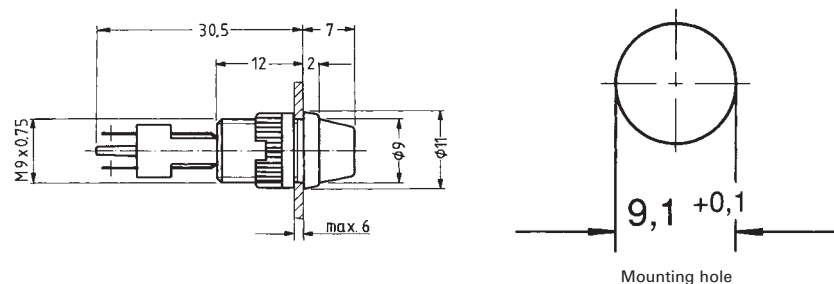

→ Color of lens	Lamp	Operating voltage U_B	Order no.
translucent red	LED	24 - 28 V	1.02.157.211/1300
translucent yellow	LED	24 - 28 V	1.02.157.211/1400
translucent green	LED	24 - 28 V	1.02.157.211/1500
translucent white	LED	24 - 28 V	1.02.157.211/1000

With integrated series resistor. Other voltages on request.

integr.
LED

SIGNAL LAMPS WITH INTEGRATED LED 10 mm



Technical Data

→ General information

Form of lens	see order block
Color of lens	see order block
Diameter of collar	12.5 mm

→ Dimensions

Overall height	see order block
Mounting depth	30.5 mm
Mounting hole	10 mm

→ Mechanical design

Mounting	pressing into hole
Terminals	quick connector 2.8 x 0.8 mm
Lamp socket	no
Lamp	see order block

→ Electrical characteristics

Operating voltage U_B	see order block
Integrated currenty resistor	see order block
Forward voltage U_F at 25 °C	at 20 mA forward current 2.4 V
Reverse voltage U_R at 25 °C	3 V
Forward current, I_F	see order block
Reverse current I_R at 25 °C	100 μ A
Power dissipation P_{tot} at 25 °C	max. 120 mW
Light intensity	see order block
Protecting diode	see order block

→ Other specifications

Degree of protection from front side	IP40 (DIN EN 60529)
Weight	2.44 g
ROHS compliant	yes
REACH compliant	yes

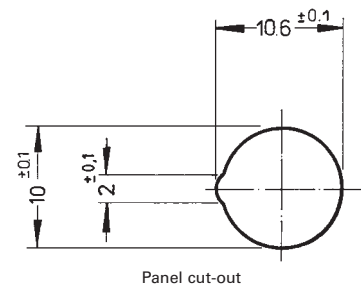

3

integr.
LED

Operating voltage U_B : DC voltage from 6 to 28 V

A suitable series resistor is installed in the unit; versions without series resistor must be fitted with an external one. A version with an additional protective diode is available to protect the LED against any voltage peaks.

External resistor: $R_v = (U_B - U_F) : I_F$

Recommended ratings of external resistors:

- for 6 - 7 V = 330 Ω 0.25 W
- for 12 - 16 V = 680 k Ω 0.5 W
- for 24 - 28 V = 1500 k Ω 1 W

SIGNAL LAMPS

SIGNAL LAMPS WITH INTEGRATED LED - 10 MM, QUICK-CONNECT TERMINAL



Signal lamp with integrated LED 10 mm, protruding LED

Technical data see page 3 - 13

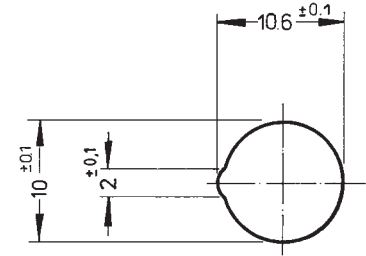
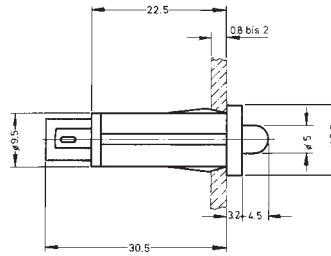

Panel cut-out

→ Color of lens	Operating voltage U_B	Integrated currency resistor	Protecting diode	Forward current, I_F	Light intensity	Order no.
red	24 - 28 V	yes	yes	15 - 20 mA	200 mcd	1.69.525.054/0000
red	24 - 28 V	yes	no	15 - 20 mA	200 mcd	1.69.525.004/0000
red	according to series resistor 6 - 28 V	no	yes	max. 20 mA	1000 mcd	1.69.525.051/0000
red	according to series resistor 6 - 28 V	no	no	max. 20 mA	200 mcd	1.69.525.001/0000
yellow	24 - 28 V	yes	yes	13 - 18.5 mA	200 mcd	1.69.525.064/0000
yellow	24 - 28 V	yes	no	13 - 18.5 mA	200 mcd	1.69.525.014/0000
yellow	according to series resistor 6 - 28 V	no	yes	max. 20 mA	200 mcd	1.69.525.061/0000
yellow	according to series resistor 6 - 28 V	no	no	max. 20 mA	200 mcd	1.69.525.011/0000
green	24 - 28 V	yes	yes	13 - 18.5 mA	1000 mcd	1.69.525.059/0000
green	24 - 28 V	yes	no	13 - 18.5 mA	1000 mcd	1.69.525.009/0000
green	according to series resistor 6 - 28 V	no	yes	max. 20 mA	1000 mcd	1.69.525.056/0000
green	according to series resistor 6 - 28 V	no	no	max. 20 mA	1000 mcd	1.69.525.006/0000

3

integr.
LED

Signal lamp with integrated LED 10 mm, round flat lens

Technical data see page 3 - 13

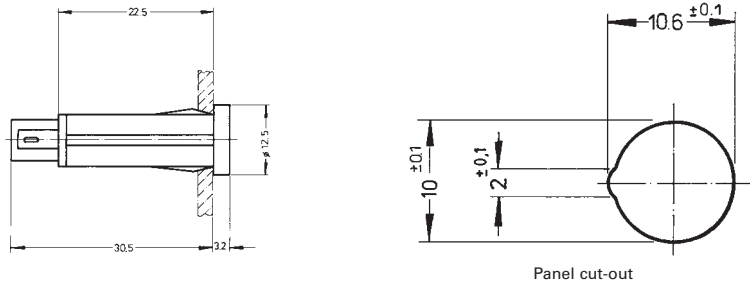

→ Color of lens	Operating voltage U_B	Integrated current resistor	Protecting diode	Forward current, I_F	Light intensity	Order no.
red	24 - 28 V	yes	yes	15 - 20 mA	200 mcd	1.69.525.255/1300
red	24 - 28 V	yes	no	15 - 20 mA	200 mcd	1.69.525.205/1300
yellow	24 - 28 V	yes	yes	13 - 18.5 mA	200 mcd	1.69.525.265/1400
yellow	24 - 28 V	yes	no	13 - 18.5 mA	200 mcd	1.69.525.215/1400
green	24 - 28 V	yes	yes	13 - 18.5 mA	1000 mcd	1.69.525.260/1500
green	24 - 28 V	yes	no	13 - 18.5 mA	1000 mcd	1.69.525.210/1500
blue	24 - 28 V	yes	yes	-	300 mcd	1.69.525.266/1600
blue	24 - 28 V	yes	no	-	300 mcd	1.69.525.216/1600
white	24 - 28 V	yes	yes	-	400 mcd	1.69.525.271/1000
white	24 - 28 V	yes	no	-	400 mcd	1.69.525.221/1000

Other voltages on request.

SIGNAL LAMPS

SIGNAL LAMPS WITH INTEGRATED LED - 11.1 MM, SOLDER TERMINALS

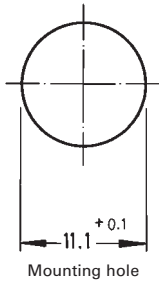

SIGNAL LAMPS WITH INTEGRATED LED 11.1 mm

Technical Data

→ General information

Form of lens	round protruding
Color of lens	see order block
Diameter of collar	13 mm

→ Dimensions

Overall height	see order block
Mounting depth	30.5 mm
Mounting hole	11.1 mm

→ Mechanical design

Mounting	ring nut
Terminals	solder terminals
Lamp socket	-
Lamp	LED

→ Electrical characteristics

Operating voltage U_B	24 - 28 V
Input current I_{cc} type.	14 mA

→ Other specifications

Degree of protection from front side	IP40 (DIN EN 60529)
Weight	3 g
ROHS compliant	yes
REACH compliant	yes

3

integr.
LED

Accessories Signal lamps with integrated LED - 11.1 mm

→ Description	Photo	Order no.	Additional accessories see page
Fixing spanner M 11, M 13		5.58.002.026/0105	5 - 25

Signal lamp with integrated LED 11.1 mm, round flat lens

Technical data see page 3 - 16

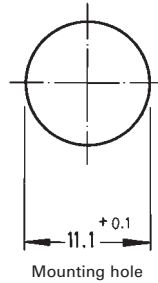
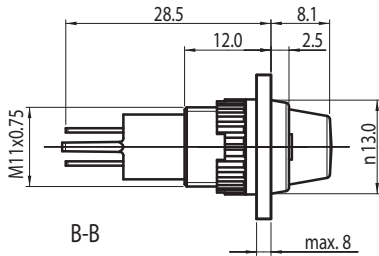

→ Color of lens	Lamp	Operating voltage U_B	Order no.
translucent red	LED	24 - 28 V	1.66.003.081/1300
translucent yellow	LED	24 - 28 V	1.66.003.081/1400
translucent green	LED	24 - 28 V	1.66.003.081/1500
translucent blue	LED	24 - 28 V	1.66.003.081/1600
translucent white	LED	24 - 28 V	1.66.003.081/1000

With integrated series resistor. Other voltages on request.

SIGNAL LAMPS

SIGNAL LAMPS WITH INTEGRATED LED - 16.2 MM, QUICK-CONNECT TERMINAL



SIGNAL LAMPS WITH INTEGRATED LED 16.2 mm, quick- connect terminal

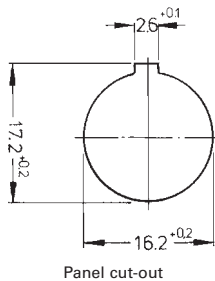

Technical Data

→ General information

Form of lens	round protruding
Color of lens	see order block
Diameter of collar	20 mm

→ Dimensions

Overall height	see order block
Mounting depth	45.8 mm
Mounting hole	16.2 mm

→ Mechanical design

Mounting	ring nut
Terminals	quick connector for 6.3 x 0.8 mm or 2x 2.8 x 0.8 mm
Lamp socket	-
Lamp	LED

→ Electrical characteristics

Operating voltage U_B	24 - 28 V
Input current I_{cc} type.	20 mA

→ Other specifications

Degree of protection from front side	IP40 (DIN EN 60529)
Weight	12 g
ROHS compliant	yes
REACH compliant	yes

3

integr.
LED

Accessories Signal lamps with integrated LED - 16.2 mm, quick-connect terminal

→ Description	Photo	Order no.	Additional accessories see page
Fixing spanner M 15, M 16		5.58.002.019/0105	5 - 25

Signal lamp with integrated LED 16.2 mm, lens round protruding

Technical data see page 3 - 18

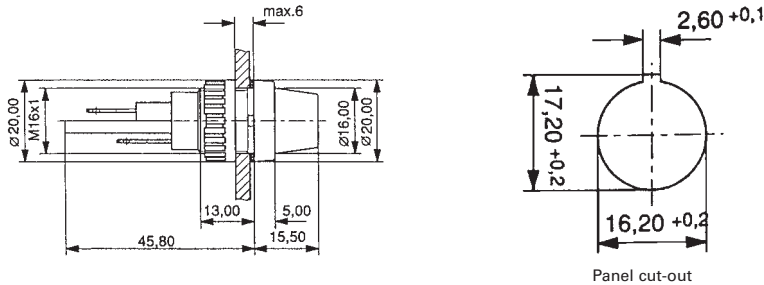

→ Color of lens	Lamp	Operating voltage U_B	Order no.
translucent red	LED	24 - 28 V	1.63.004.011/1300
translucent yellow	LED	24 - 28 V	1.63.004.011/1400
translucent green	LED	24 - 28 V	1.63.004.011/1500
translucent blue	LED	24 - 28 V	1.63.004.011/1600
translucent white	LED	24 - 28 V	1.63.004.011/1000

With integrated series resistor. Other voltages on request.

Signal lamp with integrated LED 16.2 mm, lens round

Technical data see page 3 - 18

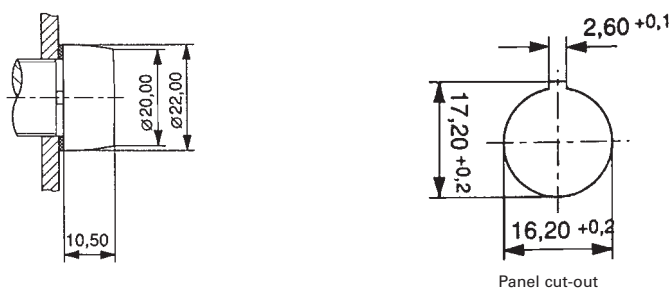

→ Color of lens	Lamp	Operating voltage U_B	Order no.
translucent red	LED	24 - 28 V	1.63.004.020/1300
translucent yellow	LED	24 - 28 V	1.63.004.020/1400
translucent green	LED	24 - 28 V	1.63.004.020/1500
translucent blue	LED	24 - 28 V	1.63.004.020/1600
translucent white	LED	24 - 28 V	1.63.004.020/1000

With integrated series resistor. Other voltages on request.

SIGNAL LAMPS

SIGNAL LAMPS WITH INTEGRATED LED - 16.2 MM, SCREW TERMINALS



SIGNAL LAMPS WITH INTEGRATED LED 16.2 mm, screw terminals

Technical Data

→ General information

Form of lens	round protruding
Color of lens	see order block
Diameter of collar	20 mm

→ Dimensions

Overall height	see order block
Mounting depth	see order block
Mounting hole	16.2 mm

→ Mechanical design

Mounting	ring nut
Terminals	screw terminals
Lamp socket	-
Lamp	LED

→ Electrical characteristics

Operating voltage U_B	24 - 28 V
Input current I_{cc} type.	20 mA

→ Other specifications

Degree of protection from front side	IP40 (DIN EN 60529)
Weight	12 g
ROHS compliant	yes
REACH compliant	yes

3

integr.
LED

Accessories Signal lamps with integrated LED - 16.2 mm, screw terminals

→ Description	Photo	Order no.	Additional accessories see page
Fixing spanner M 15, M 16		5.58.002.019/0105	5 - 25

Signal lamp with integrated LED 16.2 mm, lens round protruding

Technical data see page 3 - 20

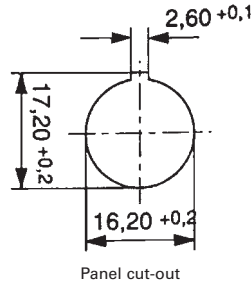
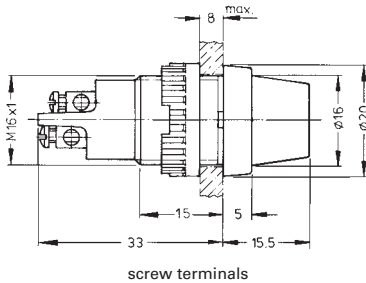

→ Color of lens	Lamp	Operating voltage U_B	Order no.
translucent red	LED	24 - 28 V	1.60.502.162/1300
translucent yellow	LED	24 - 28 V	1.60.502.162/1400
translucent green	LED	24 - 28 V	1.60.502.162/1500
translucent blue	LED	24 - 28 V	1.60.502.162/1600
translucent white	LED	24 - 28 V	1.60.502.162/1000

With integrated series resistor. Other voltages on request.

Signal lamp with integrated LED 16.2 mm, round lens

Technical data see page 3 - 20

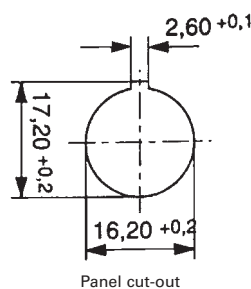
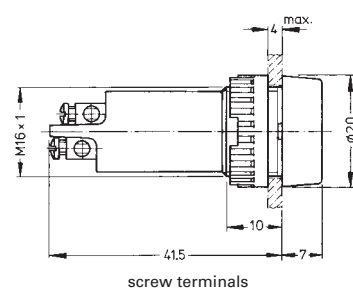

→ Color of lens	Lamp	Operating voltage U_B	Order no.
translucent red	LED	24 - 28 V	1.60.502.152/1300
translucent yellow	LED	24 - 28 V	1.60.502.152/1400
translucent green	LED	24 - 28 V	1.60.502.152/1500
translucent blue	LED	24 - 28 V	1.60.502.152/1600
translucent white	LED	24 - 28 V	1.60.502.152/1000

With integrated series resistor. Other voltages on request.

SIGNAL LAMPS

SIGNAL LAMPS WITH INTEGRATED LED - 16.2 MM, SCREW TERMINALS



Signal lamp with integrated LED 16.2 mm, lens round high

Technical data see page 3 - 20

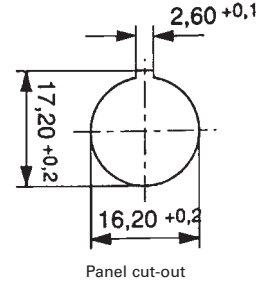
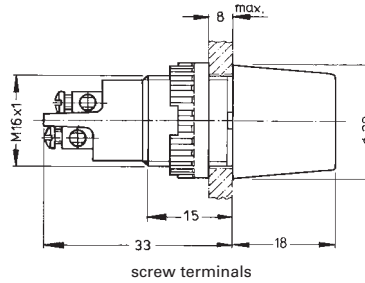

→ Color of lens	Lamp	Operating voltage U_B	Order no.
translucent red	LED	24 - 28 V	1.60.502.151/1300
translucent yellow	LED	24 - 28 V	1.60.502.151/1400
translucent green	LED	24 - 28 V	1.60.502.151/1500
translucent blue	LED	24 - 28 V	1.60.502.151/1600
translucent white	LED	24 - 28 V	1.60.502.151/1000

With integrated series resistor. Other voltages on request.

3

integr.
LED

SIGNAL LAMPS WITH INTEGRATED LED 18,2 mm

Technical Data

→ General information

Form of lens	round protruding
Color of lens	see order block
Diameter of collar	22 mm

→ Dimensions

Overall height	14 mm
Mounting depth	47 mm
Mounting hole	18.2 mm

→ Mechanical design

Mounting	ring nut
Terminals	solder terminals
Lamp socket	-
Lamp	LED

→ Electrical characteristics

Operating voltage U_B	24 - 28 V
Input current I_{cc} type.	20 mA

→ Other specifications

Degree of protection from front side	IP40 (DIN EN 60529)
Weight	15 g
ROHS compliant	yes
REACH compliant	yes

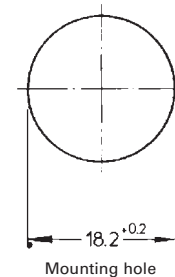
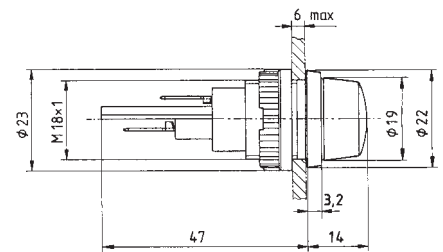

3

integr.
LED

Approvals



VDE 0710, T120°

Accessories Signal lamps with integrated LED - 18,2 mm

Description	Photo	Order no.	Additional accessories see page
Protective sleeve for terminals made of Buna N (NBR)		5.52.011.027/0100	-

SIGNAL LAMPS

SIGNAL LAMPS WITH INTEGRATED LED - 18,2 MM, QUICK-CONNECT TERMINAL



Signal lamp with integrated LED 18,2 mm, lens round protruding, ring chrome

Technical data see page 3 - 23

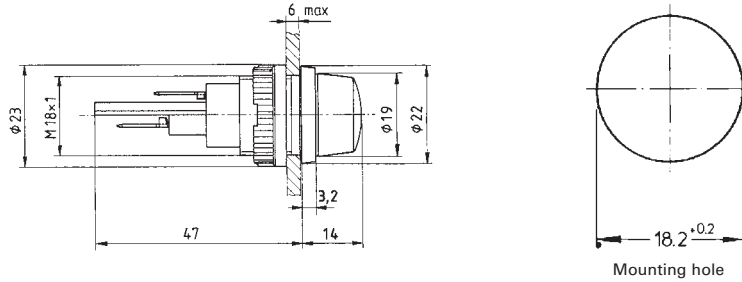

→ Color of lens	Lamp	Operating voltage U_B	Order no.
translucent red	LED	24 - 28 V	1.63.018.011/1300
translucent yellow	LED	24 - 28 V	1.63.018.011/1400
translucent green	LED	24 - 28 V	1.63.018.011/1500
translucent blue	LED	24 - 28 V	1.63.018.011/1600
translucent white	LED	24 - 28 V	1.63.018.011/1000

With integrated series resistor. Other voltages on request.

3

integr.
LED

SIGNAL LAMPS WITH INTEGRATED LED 22,3 mm



Technical Data

→ General information	
Form of lens	round
Color of lens	see order block
Diameter of collar	28 mm
→ Dimensions	
Overall height	14 mm
Mounting depth	46 mm
Mounting hole	22.3 mm
→ Mechanical design	
Mounting	ring nut
Terminals	screw terminals brass nickel-plated
Lamp socket	-
Lamp	LED
→ Electrical characteristics	
Operating voltage U_B	24 - 28 V
Input current I_{cc} type.	16 mA
→ Other specifications	
Degree of protection from front side	IP40 (DIN EN 60529)
Weight	24 g
ROHS compliant	yes
REACH compliant	yes

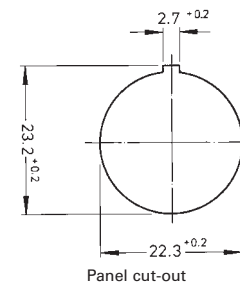
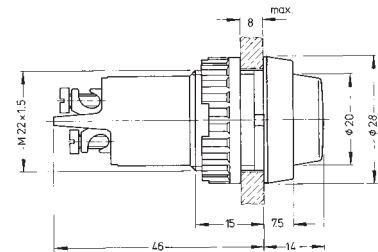

3

integr.
LED

Approvals



VDE 85°

Accessories Signal lamps with integrated LED - 22,3 mm

Description	Photo	Order no.	Additional accessories see page
Sealing ring for IP65		5.30.075.010/0100	5 - 30
Protection against contact to VBG 4		5.50.240.063/0209	5 - 31
Protective sleeve for terminals made of Buna N (NBR)		5.52.011.029/0100	-
Fixing spanner M 20, M 22, for ring nut		5.58.002.018/0105	5 - 25

SIGNAL LAMPS

SIGNAL LAMPS WITH INTEGRATED LED - 22.3 MM, SCREW TERMINALS



Signal lamp with integrated LED 22.3 mm, lens round

Technical data see page 3 - 25

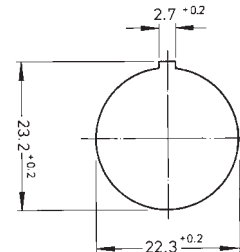
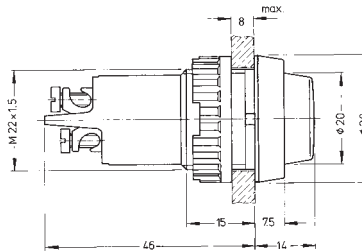

Panel cut-out

→ Color of lens	Lamp	Operating voltage U_B	Order no.
translucent red	LED	24 - 28 V	1.61.012.015/1300
translucent yellow	LED	24 - 28 V	1.61.012.015/1400
translucent green	LED	24 - 28 V	1.61.012.015/1500
translucent white	LED	24 - 28 V	1.61.012.015/1000

3

With integrated series resistor. Other voltages on request.



Signal lamp with integrated LED 22.3 mm, lens round flat

Technical data see page 3 - 25

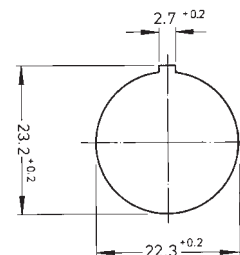
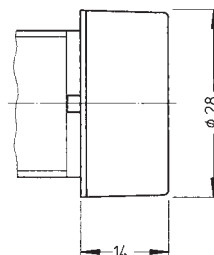

Panel cut-out

→ Color of lens	Lamp	Operating voltage U_B	Order no.
translucent red	LED	24 - 28 V	1.61.012.062/1300
translucent yellow	LED	24 - 28 V	1.61.012.062/1400
translucent green	LED	24 - 28 V	1.61.012.062/1500
translucent white	LED	24 - 28 V	1.61.012.062/1000

With integrated series resistor. Other voltages on request.

integr.
LED

SIGNAL LAMPS WITH INTEGRATED LED 30.5 mm



Technical Data

→ General information

Form of lens	round
Color of lens	see order block
Diameter of collar	36 mm

→ Dimensions

Overall height	see order block
Mounting depth	58 mm
Mounting hole	30,5 ^{+0,5} mm

→ Mechanical design

Mounting	ring nut
Terminals	quick connector for 2 x 2.8 x 0.8 mm
Lamp socket	-
Lamp	LED

→ Electrical characteristics

Operating voltage U_B	see order block
Input current I_{CC} type.	see order block

→ Other specifications

Degree of protection from front side	see order block
Weight	38 g
ROHS compliant	yes
REACH compliant	yes

Accessories Signal lamps with integrated LED - 30.5 mm

→ Description	Photo	Order no.	Additional accessories see page
Fixing spanner M 25, M 30		5.58.002.020/0105	5 - 25

SIGNAL LAMPS

SIGNAL LAMPS WITH INTEGRATED LED - 30.5 MM, QUICK CONNECTOR



Signal lamp with integrated LED 30.5 mm, lens round

Technical data see page 3 - 27

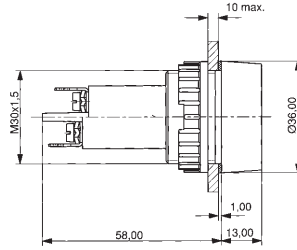

with lens round

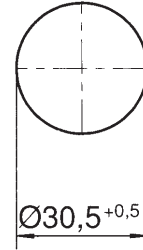

Mounting hole

→ Color of lens	Operating voltage U_B	Input current I_{cc} type.	Order no.
translucent red	24-28 V	16 mA	1.63.521.002/1300
translucent red	110 V	6 mA	1.63.521.003/1300
translucent red	230 V	5 mA	1.63.521.024/1300
translucent yellow	24-28 V	16 mA	1.63.521.002/1400
translucent yellow	110 V	6 mA	1.63.521.003/1400
translucent yellow	230 V	5 mA	1.63.521.024/1400
translucent green	24-28 V	16 mA	1.63.521.002/1500
translucent green	110 V	6 mA	1.63.521.003/1500
translucent green	230 V	5 mA	1.63.521.024/1500
translucent white	24-28 V	16 mA	1.63.521.002/1000
translucent white	110 V	6 mA	1.63.521.003/1000
translucent white	230 V	5 mA	1.63.521.024/1000

With integrated series resistor.

3

integr.
LED

Signal lamp with integrated LED 30.5 mm, lens round flat

Technical data see page 3 - 27

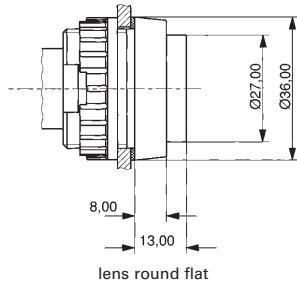

→ Color of lens	Operating voltage U_B	Input current I_{cc} type.	Order no.
translucent red	24-28 V	16 mA	1.63.521.005/1300
translucent red	110 V	6 mA	1.63.521.006/1300
translucent red	230 V	5 mA	1.63.521.007/1300
translucent yellow	24-28 V	16 mA	1.63.521.005/1400
translucent yellow	110 V	6 mA	1.63.521.006/1400
translucent yellow	230 V	5 mA	1.63.521.007/1400
translucent green	24-28 V	16 mA	1.63.521.005/1500
translucent green	110 V	6 mA	1.63.521.006/1500
translucent green	230 V	5 mA	1.63.521.007/1500
translucent white	24-28 V	16 mA	1.63.521.005/1000
translucent white	110 V	6 mA	1.63.521.006/1000
translucent white	230 V	5 mA	1.63.521.007/1000

With integrated series resistor.

SIGNAL LAMPS

SIGNAL LAMPS WITH INTEGRATED LED - 30.5 MM, QUICK CONNECTOR



Signal lamp with integrated LED 30.5 mm, lens round high

Technical data see page 3 - 27

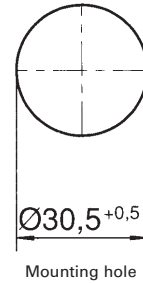
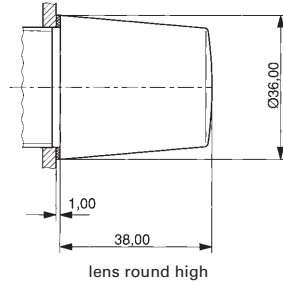

→ Color of lens	Operating voltage U_B	Input current I_{cc} type.	Order no.
translucent red	24-28 V	16 mA	1.63.521.012/1300
translucent red	110 V	6 mA	1.63.521.013/1300
translucent red	230 V	5 mA	1.63.521.014/1300
translucent yellow	24-28 V	16 mA	1.63.521.012/1400
translucent yellow	110 V	6 mA	1.63.521.013/1400
translucent yellow	230 V	5 mA	1.63.521.014/1400
translucent green	24-28 V	16 mA	1.63.521.012/1500
translucent green	110 V	6 mA	1.63.521.013/1500
translucent green	230 V	5 mA	1.63.521.014/1500
translucent white	24-28 V	16 mA	1.63.521.012/1000
translucent white	110 V	6 mA	1.63.521.013/1000
translucent white	230 V	5 mA	1.63.521.014/1000

With integrated series resistor.

3

integr.
LED



Signal lamps

with integrated lamp

Signal lamps with integral neon lamp or neon glow lamp.
The mm specification in the product name indicates the appropriate mounting hole diameter of the signal lamps.

- All products are RoHS compliant.

SIGNAL LAMPS

SIGNAL LAMPS WITH INTEGRATED LAMP

Content

Signal lamps with integrated neon lamp 7 mm	3 - 33
Signal lamp with integrated filament/neon lamp 7 mm, solder terminals	3 - 33
Signal lamps with integrated neon lamp 10 mm	3 - 35
Signal lamp with integrated neon lamp 10 mm, round lens	3 - 35
Signal lamps with integrated neon lamp 10 mm	3 - 37
Signal lamp with integrated neon lamp 10 mm, round lens	3 - 38
Signal lamp with integrated neon lamp 10 mm, square lens	3 - 38
Signal lamp with integrated neon lamp 10 mm, lens in arrow shape	3 - 39
Signal lamps with integrated neon lamp 14 mm	3 - 40
Signal lamp with integrated neon lamp 14 mm, round lens, 230 V	3 - 40

3

integr.
Lamp

SIGNAL LAMPS WITH INTEGRATED NEON LAMP 7 mm

Technical Data

→ General information

Form of lens	round
Color of lens	see order block
Diameter of collar	8.5

→ Dimensions

Overall height	5 mm
Mounting depth	see order block
Mounting hole	7 mm

→ Mechanical design

Mounting	pressing into hole
Terminals	see order block
Lamp socket	no
Lamp	see order block

→ Electrical characteristics

Voltage limit max.	see order block
--------------------	-----------------

→ Other specifications

Operating life	see order block
Degree of protection from front side	IP40 (DIN EN 60529)
Weight	0.87 g
ROHS compliant	yes
REACH compliant	yes

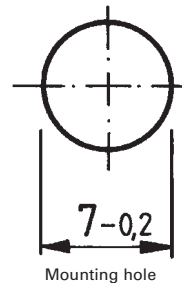

Approvals



VDE T85° (only version with neon lamp)

3

integr.
Lamp

Signal lamp with integrated filament/neon lamp 7 mm, solder terminals

Technical data see page 3 - 33

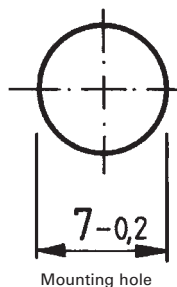
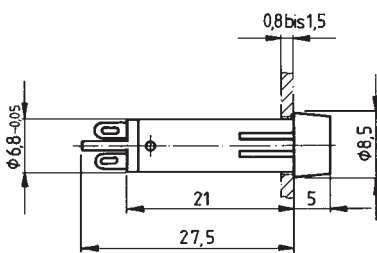

SIGNAL LAMPS

SIGNAL LAMPS WITH INTEGRATED NEON LAMP - 7 MM, SOLDER TERMINALS

– Table (continued) –

Signal lamps with integrated filament/neon lamp - 7 mm, solder terminals

→ Color of lens	Lamp	Voltage limit max.	Terminals	Order no.
transparent red	neon lamp	230 V	solder terminals	1.69.511.059/1301
transparent yellow	neon lamp	230 V	solder terminals	1.69.511.059/1402
transparent colorless	neon lamp	230 V	solder terminals	1.69.511.059/1002

Other voltages on request.

3

integr.
Lamp

SIGNAL LAMPS WITH INTEGRATED NEON LAMP 10 mm

Technical Data

→ General information

Form of lens	see order block
Color of lens	see order block
Diameter of collar	see order block

→ Dimensions

Length of collar	see order block
Width of collar	see order block
Overall height	1.2 mm
Mounting depth	32 mm
Mounting hole	10 mm

→ Mechanical design

Mounting	pressing into hole
Terminals	quick connector 2.8 x 0.8 mm
Lamp socket	no
Lamp	see order block

→ Electrical characteristics

Voltage limit max.	see order block
--------------------	-----------------

→ Other specifications

Degree of protection from front side	IP40 (DIN EN 60529)
Weight	2.5 g
ROHS compliant	yes
REACH compliant	yes

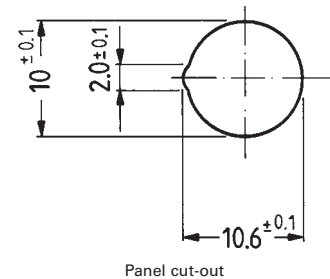

Approvals



VDE T85° (only version with neon lamp)

3

integr.
Lamp

Signal lamp with integrated neon lamp 10 mm, round lens

Technical data see page 3 - 35

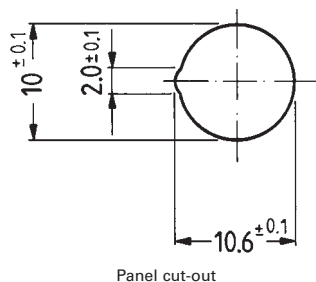
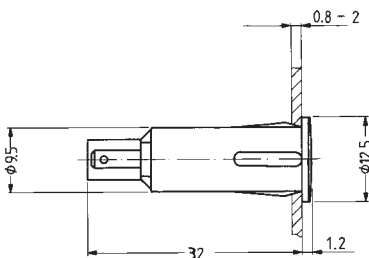

SIGNAL LAMPS

SIGNAL LAMPS WITH INTEGRATED NEON LAMP - 10 MM, QUICK-CONNECT TERMINAL

– Table (continued) –

Signal lamps with integrated neon lamp - 10 mm, round lens

→ Color of lens	Lamp	Voltage limit max.	Order no.
transparent red	neon lamp	230 V	1.69.527.104/1301
transparent yellow	neon lamp	230 V	1.69.527.104/1402
transparent colorless	neon lamp	230 V	1.69.527.104/1002

3

integr.
Lamp

SIGNAL LAMPS WITH INTEGRATED NEON LAMP 10 mm



Technical Data

→ General information

Form of lens	see order block
Color of lens	see order block
Diameter of collar	see order block

→ Dimensions

Length of collar	see order block
Width of collar	see order block
Overall height	3 mm
Mounting depth	30 mm
Mounting hole	10 mm

→ Mechanical design

Mounting	pressing into hole
Terminals	see order block
Lamp socket	no
Lamp	see order block

→ Electrical characteristics

Voltage limit max.	see order block
--------------------	-----------------

→ Other specifications

Degree of protection from front side	IP40 (DIN EN 60529)
Weight	2.5 g
ROHS compliant	yes
REACH compliant	yes

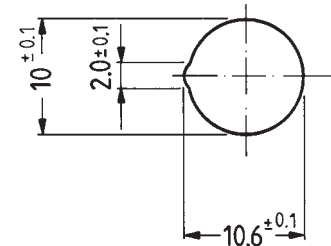
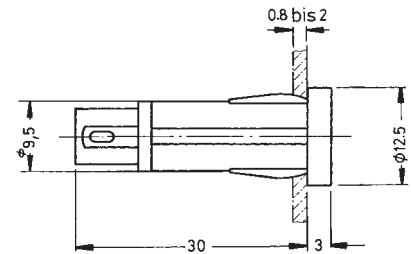

Panel cut-out

3

integr.
Lamp

Approvals



VDE 0710 (T85°
for filament and
T120° for neon
lamp versions)

SIGNAL LAMPS

SIGNAL LAMPS WITH INTEGRATED NEON LAMP - 10 MM, QUICK-CONNECT TERMINAL



Signal lamp with integrated neon lamp 10 mm, round lens

Technical data see page 3 - 37

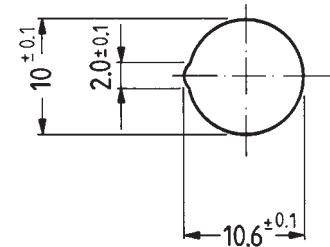
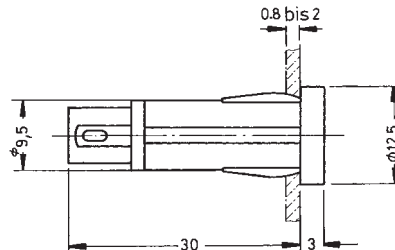

Panel cut-out

→ Color of lens	Lamp	Voltage limit max.	Terminals	Order no.
transparent red	neon lamp	230 V	quick connector 2.8 x 0.8 mm	1.69.507.117/1301
transparent yellow	neon lamp	230 V	quick connector 2.8 x 0.8 mm	1.69.507.117/1402
transparent green	neon glow lamp	230 V	quick connector 2.8 x 0.8 mm	1.69.507.118/1502
transparent colorless	neon lamp	230 V	quick connector 2.8 x 0.8 mm	1.69.507.117/1002

Other voltages and versions with connection cable on request.



Signal lamp with integrated neon lamp 10 mm, square lens

Technical data see page 3 - 37

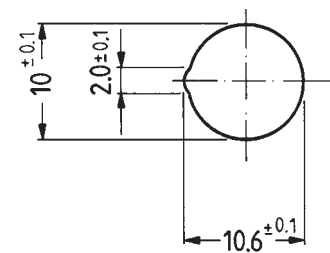
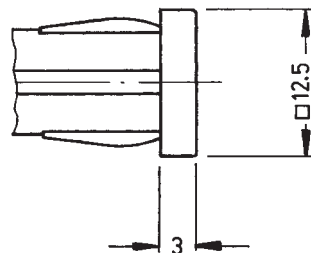

Panel cut-out

→ Color of lens	Lamp	Voltage limit max.	Terminals	Order no.
transparent red	neon lamp	230 V	quick connector 2.8 x 0.8 mm	1.69.507.137/1301
transparent yellow	neon lamp	230 V	quick connector 2.8 x 0.8 mm	1.69.507.137/1402
transparent green	neon glow lamp	230 V	quick connector 2.8 x 0.8 mm	1.69.507.138/1502
transparent colorless	neon lamp	230 V	quick connector 2.8 x 0.8 mm	1.69.507.137/1002

Other voltages and versions with connection cable on request.

3

integr.
Lamp

Signal lamp with integrated neon lamp 10 mm, lens in arrow shape

Technical data see page 3 - 37

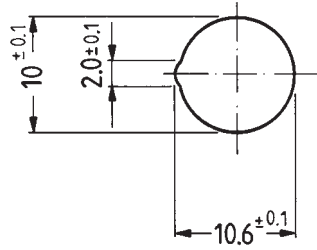
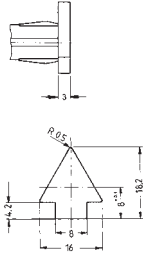

Panel cut-out



→ Color of lens	Lamp	Voltage limit max.	Terminals	Order no.
transparent red	neon lamp	230 V	quick connector 2.8 x 0.8 mm	1.69.507.157/1301
transparent yellow	neon lamp	230 V	quick connector 2.8 x 0.8 mm	1.69.507.157/1402
transparent green	neon glow lamp	230 V	quick connector 2.8 x 0.8 mm	1.69.507.158/1502
transparent colorless	neon lamp	230 V	quick connector 2.8 x 0.8 mm	1.69.507.157/1002

Other voltages and versions with connection cable on request.

SIGNAL LAMPS

SIGNAL LAMPS WITH INTEGRATED NEON LAMP - 14 MM, QUICK-CONNECT TERMINAL



SIGNAL LAMPS WITH INTEGRATED NEON LAMP 14 mm

Technical Data

→ General information

Form of lens	see order block
Color of lens	see order block

→ Dimensions

Dimensions of collar	see order block
Overall height	4 mm
Mounting depth	see order block
Mounting hole	14 mm

→ Mechanical design

Mounting	pressing into hole
Terminals	see order block
Lamp socket	no
Lamp	see order block

→ Electrical characteristics

Voltage limit max.	see order block
--------------------	-----------------

→ Other specifications

Degree of protection from front side	IP40 (DIN EN 60529)
Weight	5 g
ROHS compliant	yes
REACH compliant	yes

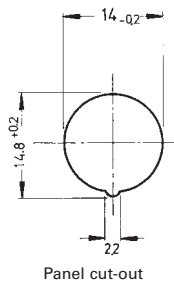

Approvals



VDE T85° (only version with neon lamp)

3

integr.
Lamp



Signal lamp with integrated neon lamp 14 mm, round lens, 230 V

Technical data see page 3 - 40

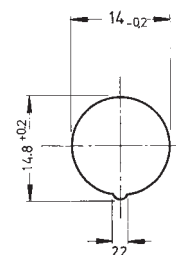
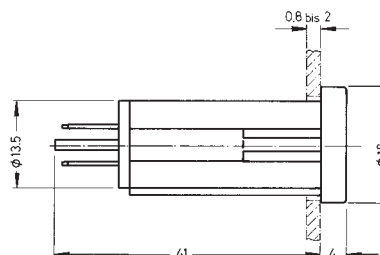

SIGNAL LAMPS

SIGNAL LAMPS WITH INTEGRATED NEON LAMP - 14 MM, QUICK-CONNECT TERMINAL

– Table (continued) –
Signal lamps with integrated neon lamp - 14 mm, round lens, 230 V

→ Color of lens	Lamp	Voltage limit max.	Terminals	Order no.
transparent red	neon lamp	230 V	quick connector 2.8 x 0.8 mm	1.02.614.502/1301
transparent yellow	neon lamp	230 V	quick connector 2.8 x 0.8 mm	1.02.614.502/1402
transparent green	neon glow lamp	230 V	quick connector 2.8 x 0.8 mm	1.02.614.503/1502
transparent colorless	neon lamp	230 V	quick connector 2.8 x 0.8 mm	1.02.614.502/1002

3

integr.
Lamp

4

PCB KEY SWITCHES



MICON 5 Tactile switches	4 - 3
MICON 5 - Tactile switches	4 - 5
MICON 5 - Plungers round, not illuminable	4 - 10
- NEW - MICON 5 - Plungers round, ring illumination	4 - 14
MICON 5 - Plungers square, illuminable	4 - 17
- NEW - MICON 5 - Plungers square, spot-illumination	4 - 22
MICON 5 - Plungers for signal indicator	4 - 26
RACON Tactile switches	4 - 31
RACON 8 - Tactile switches	4 - 33
RACON 12 - Tactile switches	4 - 39
RACON 12 V - Tactile switches with vertical adapter	4 - 45
RACON 12 i - Tactile switches	4 - 47
RACON 8/12 - Special accessories	4 - 49
RK 90 II, Key cap system for RACON 12	4 - 52
RF Tactile switches	4 - 55
RF 15 - Tactile switches	4 - 58
RF 15 N - Tactile switches	4 - 62
RF 15 R low - Tactile switches	4 - 67
RF 15 H - Tactile switches	4 - 73
RF 15 - Signal indicators	4 - 78
RF 19 - Tactile switches	4 - 81
RF 19 H - Tactile switches	4 - 86
RF 19 - Signal indicators	4 - 91
RF 15/19 - Special accessories	4 - 95
KN 19 Short-travel main switch	4 - 101
KN 19 - Short-travel main switches	4 - 103
RK 90 Keycaps	4 - 105
RK 90 - Keycaps, plastic, 9 x 9 mm	4 - 109
RK 90 - Keycaps, plastic 14 mm	4 - 111
RK 90 - Keycaps, aluminium, 14 mm	4 - 115
RK 90 - Special accessories	4 - 118
RG 85 III Short-travel system	4 - 121
RG 85 III - Pushbuttons/keys	4 - 125
RG 85 III - Keylock switches	4 - 128
RG 85 III - Signal indicator, without lens	4 - 131
RG 85 III - Special accessories	4 - 133
RS 76 Full-travel key switches	4 - 143
RS 76 M - Full-travel key switches, non-illuminated	4 - 150
RS 76 M - Full-travel key switches, illuminated	4 - 153
RS 76 C - Full-travel key switches, non-illuminated	4 - 156
RS 76 C - Full-travel key switches, illuminated	4 - 158
RS 76 - Keycaps, non-illuminated	4 - 161
RS 76 - Keycaps, illuminated	4 - 163
RS 76 - Keycaps, with legend, two-shot molded/keycap sets	4 - 166
RS 76 - Special accessories	4 - 168
Keylock / rotary switches for PCB	4 - 171
MICROMECH - Keylock switches IP 54	4 - 173
EUROLOCKS - Keylock switches IP 54	4 - 177
Priority keylock switches IP 54	4 - 179
Rotary switches IP40	4 - 181

PCB KEY SWITCHES

MICON 5 - TACTILE SWITCHES



MICON 5

Tactile switches

Tactile switch range MICON 5, with clear key click and extremely reliable switching. Use under overlay or under keycaps RK 90. THT and SMT versions which can be mounted automatically. All products are RoHS compliant.

4

MICON

PCB KEY SWITCHES

MICON 5 - TACTILE SWITCHES

Content

MICON 5 - Tactile switches

MICON 5 - Tactile switch, SMT Standard	4 - 5
MICON 5 - Tactile switch, SMT low	4 - 8
MICON 5 - Tactile switch, THT Standard	4 - 8
MICON 5 - Tactile switch, THT Standard	4 - 9

MICON 5 - Plungers round, not illuminable

MICON 5 - Plunger opaque, round, not illuminable	4 - 10
MICON 5 - Plunger opaque, round, not illuminable	4 - 12

MICON 5 - Plungers round, ring illumination

MICON 5 - Plunger round, ring illumination	4 - 14
MICON 5 - Plunger round, ring illumination	4 - 16

MICON 5 - Plungers square, illuminable

MICON 5 - Plunger square, illuminable, 11 x 11 mm	4 - 17
MICON 5 - Plunger square, illuminable, 11 x 11 mm	4 - 19
MICON 5 - Plunger square, illuminable, 14.5 x 14.5 mm	4 - 19
MICON 5 - Plunger square, illuminable, 18 x 18 mm	4 - 20

MICON 5 - Plungers square, spot-illumination

MICON 5 - Plunger square, spot-illumination, plunger 14.5 x 14.5 mm	4 - 22
MICON 5 - Plunger square, spot-illumination, plunger 14.5 x 14.5 mm	4 - 24
MICON 5 - Plunger square, spot-illumination, plunger 18 x 18 mm	4 - 24

MICON 5 - Plungers for signal indicator

MICON 5 - Plunger for signal indicator, 1-module	4 - 26
MICON 5 - Plunger for signal indicator, 1-module	4 - 28
MICON 5 - Plunger for signal indicator, 2-module	4 - 28

MICON 5 Tactile switches

→ MICON 5 tactile switches offer an extremely high switching reliability while needing very little space. They can be arranged as single keys, in rows or key blocks.

When arranged under an overlay, MICON key switches should be combined with plungers.

The features at a glance:

- Suitable for the most common soldering methods
 - Wave soldering bath for THT versions
 - Reflow soldering for SMT version
 - Vapour phase soldering for SMT versions
 - Manual soldering
- SMT version suitable for processing with an automatic SMT assembly machines
- IMDS listed

You can download actual product information from our internet site www.rafi.de / Catalogues and Downloads

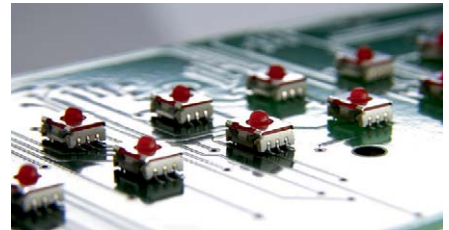
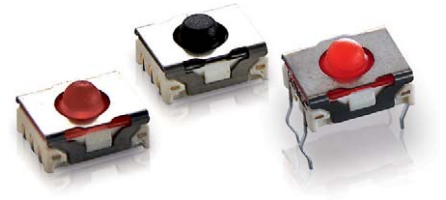

Technical Data

→ Dimensions

Length of housing	6.4 mm
Width of housing	5.1 mm
Overall height	see order block

→ Mechanical design

Mounting	soldering
Terminals	see order block
Contact system	snap-action contact
Contact arrangement	1 NO
Contact materials	Au
Illumination	no

→ Mechanical characteristics

Operating force F1 (±20%)	see order block
Switching travel S2 (±0.15 mm)	see order block

→ Electrical characteristics

Rated voltage min.	0.02 V
Rated voltage max.	35 V
Rated current min.	0.01 mA
Rated current max.	100 mA
Rated power max. (ohmic load)	1 W
Contact resistance when new	≤ 100 mΩ
Rated voltage resistance AC	250 V
Insulation resistance	10 ⁹ Ω

→ Other specifications

Ambient temp. operating min.	-40 °C
Ambient temp. operating max.	+90 °C
Resistance to environment	IEC 60068-2 -14,-30,-33, -78
Operating life (test force)	see order block
Solder heat resistance / Solderability	see order block
Flammability of materials	UL 94 V1
Packing	see order block
Produkt type	see order block
ROHS compliant	yes
REACH compliant	yes

PCB KEY SWITCHES

MICON 5 - TACTILE SWITCHES

MICON 5 Circuit diagram acc. to IEC 617

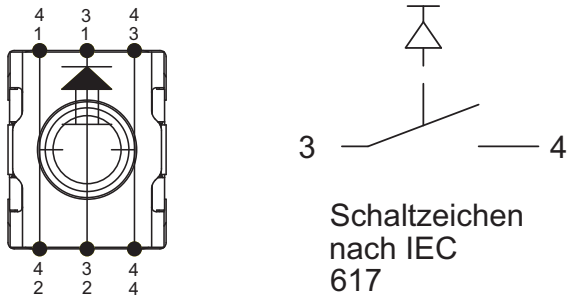

The two outer contacts must be connected.

MICON 5 Force-travel diagram

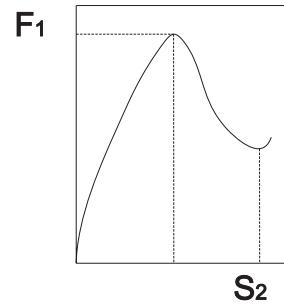

Operating force F1 and switching travel S2 see order block.

MICON 5 Product code acc. to DIN EN ISO 9001 (EN ISO 8402)

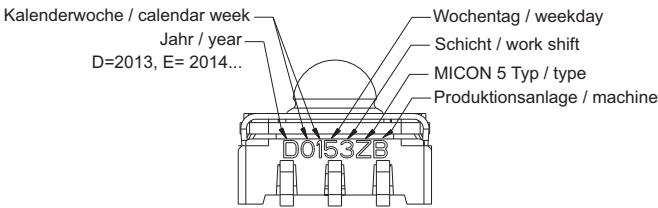

Solder pad

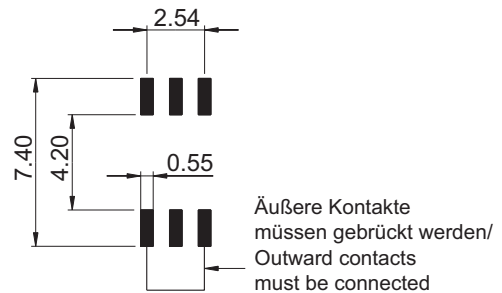

A 7-digit code is printed on the housing of the key switch. This code informs about production date, type and production shift.

MICON 5 SMT version, tape and reel

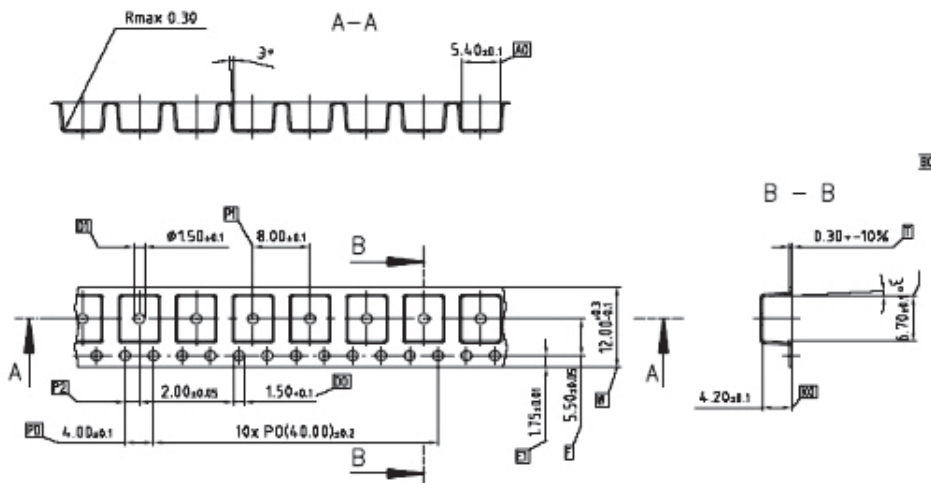

4

MICON

PCB KEY SWITCHES

MICON 5 - TACTILE SWITCHES

PCB pattern, smallest grid (without plungers)

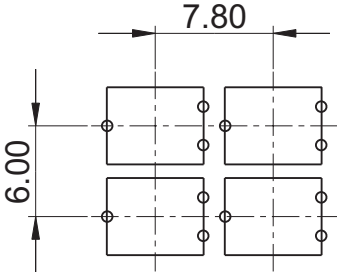

MICON 5 THT

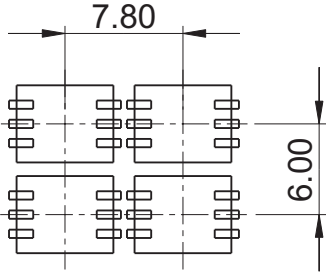

MICON 5 SMT

PCB KEY SWITCHES

MICON 5 - TACTILE SWITCHES

MICON 5 Tactile switch, SMT Standard

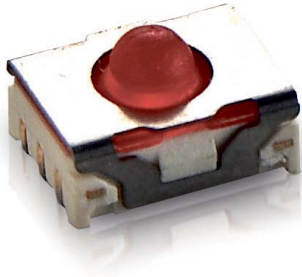

Technical data see page 4 - 5

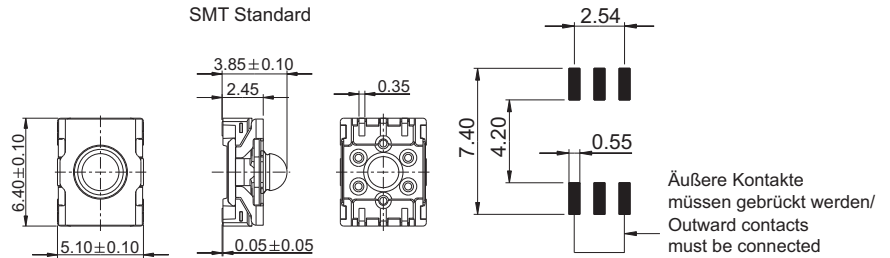

→ Produkt type	Terminals	Solder heat resistance / Solderability	Operating force F1 (±20%)	Switching travel S2 (±0.15 mm)	Operating life (test force)	Order no.
X	SMT	DIN EN 60068-2-58	2.9 N	0.7 mm	1,000,000 (4 N)	1.14.002.101/0000
Z	SMT	DIN EN 60068-2-58	3.6 N	0.8 mm	250,000 (6 N)	1.14.002.001/0000
W	SMT	DIN EN 60068-2-58	5.5 N	0.9 mm	1,000,000 (8 N)	1.14.002.111/0000
Y	SMT	DIN EN 60068-2-58	8.0 N	1.1 mm	250,000 (12 N)	1.14.002.011/0000
J	SMT	DIN EN 60068-2-58	1.5 N	0.5 mm	1,000,000 (4 N)	1.14.002.201/0000

Packing: in tape, reel with 2100 pieces
Keycaps see RK 90

Mounting hints:

Special pipette (Siemens Siplace order no.: 348514-02), mounting with collect and place head
Recommendation for screen printing: 150 µm stencil with 10% reduction of the pad size.

The key switch **1.14.002.201/0000** does not provide tactile and audible feedback. It is therefore generally used only as a **redundant auxiliary switch** to other MICON standard switches, if this is required for safety reasons.

4

MICON 5 Tactile switch, SMT low



Technical data see page 4 - 5

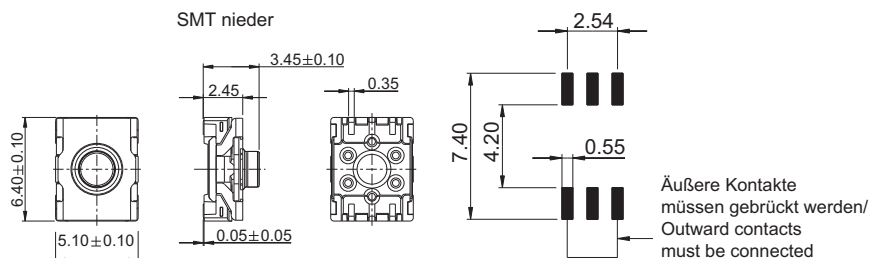

→ Produkt type	Terminals	Solder heat resistance / Solderability	Operating force F1 (±20%)	Switching travel S2 (±0.15 mm)	Operating life (test force)	Order no.
S	SMT	DIN EN 60068-2-58	3.0 N	0.6 mm	1,000,000 (4 N)	1.14.002.103/0000
T	SMT	DIN EN 60068-2-58	3.6 N	0.7 mm	250,000 (6 N)	1.14.002.003/0000

– Table (continued) –
MICON 5 - Tactile switch, SMT low

→ Produkt type	Terminals	Solder heat resistance / Solderability	Operating force F1 (±20%)	Switching travel S2 (±0.15 mm)	Operating life (test force)	Order no.
L	SMT	DIN EN 60068-2-58	5.5 N	0.7 mm	1,000,000 (8 N)	1.14.002.113/0000

Packing: in tape, reel with 2100 pieces
Keycaps see RK 90

Mounting hints:

Special pipette (Siemens Siplace order no.: 348514-02), mounting with collect and place head
Recommendation for screen printing: 150 µm stencil with 10% reduction of the pad size.

MICON 5 Tactile switch, THT Standard

Technical data see page 4 - 5

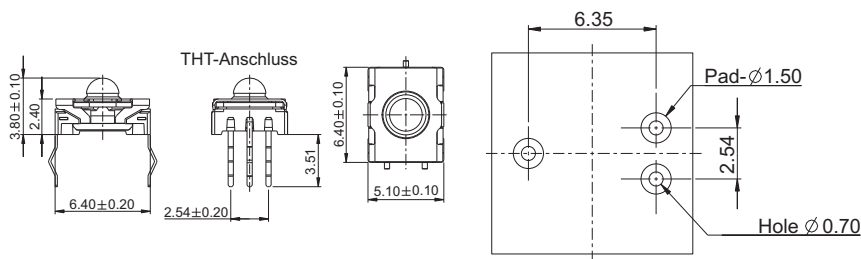

→ Produkt type	Terminals	Solder heat resistance / Solderability	Operating force F1 (±20%)	Switching travel S2 (±0.15 mm)	Operating life (test force)	Order no.
O	THT	DIN EN 60068-2-20	3.0 N	0.7 mm	1,000,000 (4 N)	1.14.002.106/0000
Q	THT	DIN EN 60068-2-20	3.6 N	0.8 mm	250,000 (6 N)	1.14.002.006/0000
N	THT	DIN EN 60068-2-20	5.5 N	0.9 mm	1,000,000 (8 N)	1.14.002.116/0000
P	THT	DIN EN 60068-2-20	8.0 N	1.1 mm	250,000 (12 N)	1.14.002.016/0000

Packing: in tubes with 102 pieces
Keycaps see RK 90

PCB KEY SWITCHES

MICON 5 - PLUNGER ROUND, NOT ILLUMINABLE

MICON 5 Plungers round, not illuminable

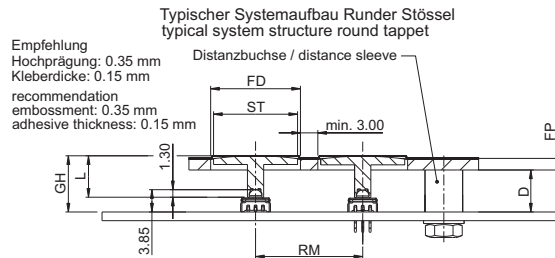

→ Description

A - Height of key switch: SMT type: 3.85 mm, THT type: 3.80 mm

D - Length of spacer $D = GH - KP - FP$

FD - Front panel cut-out $FD = ST + 1$ mm

FP - Front panel thickness

GH - Overall height: $GH = A + L1 + 0.05$ (SMT type), $GH = A + L1$ (THT type)

L - Overall length of plunger

RM - Key grid

ST - Diameter of plunger

The plungers can only be combined with MICON 5 version Standard (red bubble).

Technical Data

→ General information

Plunger diameter/size ST	see order block
Length of plunger L	see order block
Overall height GH with embossing	see order block
9.2 mm compatible	see order block

→ Other specifications

ROHS compliant	yes
REACH compliant	yes

Typical system design under overlay, round plungers, opaque, non-illuminable

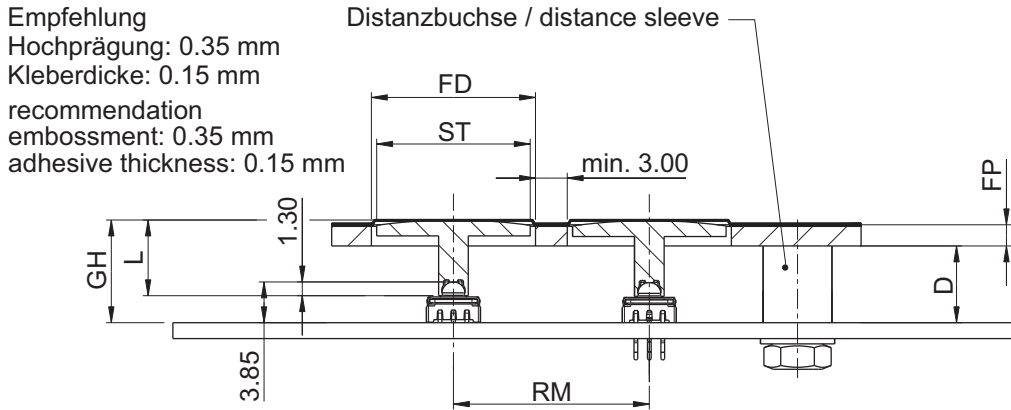

RAFI standard system design, 9.70 mm height, round plunger, opaque, non-illuminable

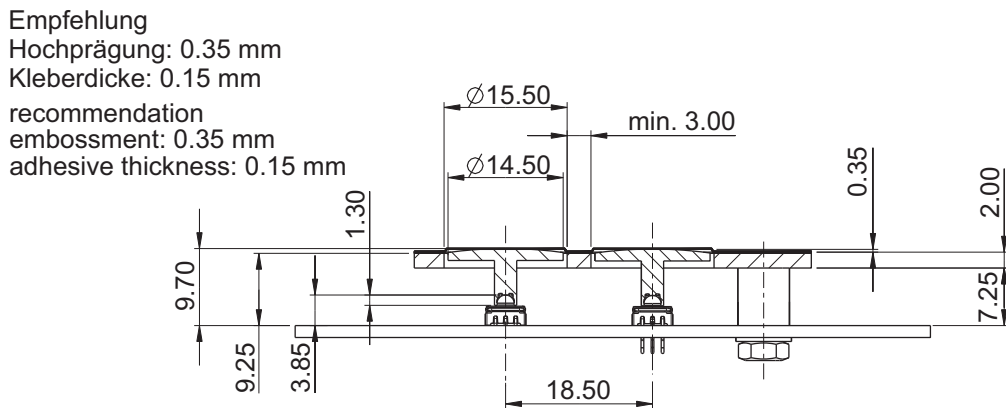

Lowest system design, 5.55 mm height, round plunger, opaque, non-illuminable

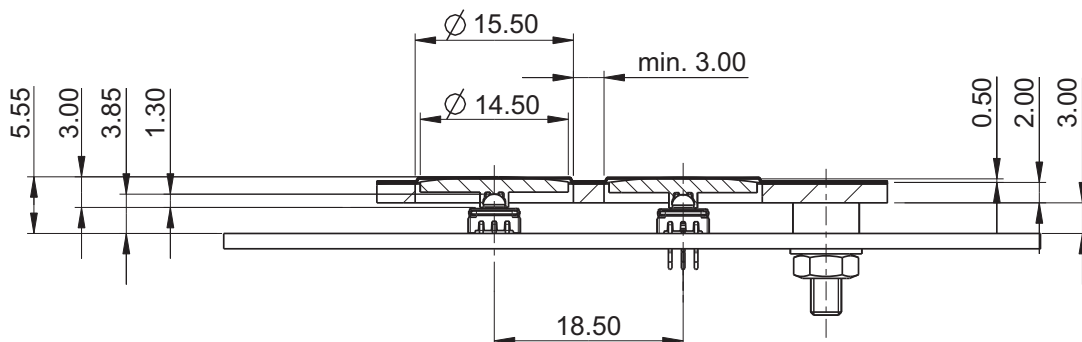

PCB KEY SWITCHES

MICON 5 - PLUNGER ROUND, NOT ILLUMINABLE



MICON 5 Plunger opaque, round, not illuminable

Technical data see page 4 - 10

→ Plunger diameter/size ST	Length of plunger L	Overall height GH with embossing	9.2 mm compatible	Order no.
6.0 mm	3.00 mm	5.55 mm	-	5.46.001.103/0200
6.0 mm	3.45 mm	6.0 mm	-	5.46.001.104/0200
6.0 mm	3.95 mm	6.5 mm	-	5.46.001.105/0200
6.0 mm	4.45 mm	7.0 mm	-	5.46.001.106/0200
6.0 mm	7.15 mm	9,7 mm	yes	5.46.001.107/0200
6.0 mm	9.95 mm	12,5 mm	-	5.46.001.108/0200
8.0 mm	3.00 mm	5.55 mm	-	5.46.001.123/0200
8.0 mm	3.45 mm	6.0 mm	-	5.46.001.124/0200
8.0 mm	3.95 mm	6.5 mm	-	5.46.001.125/0200
8.0 mm	4.45 mm	7.0 mm	-	5.46.001.126/0200
8.0 mm	5.50 mm	8.5 mm	-	5.46.001.121/0200
8.0 mm	7.15 mm	9,7 mm	yes	5.46.001.127/0200
8.0 mm	9.95 mm	12,5 mm	-	5.46.001.128/0200
8.0 mm	10.30 mm	12.85 mm	-	5.46.001.122/0200
11.5 mm	3.00 mm	5.55 mm	-	5.46.001.143/0200
11.5 mm	3.45 mm	6.0 mm	-	5.46.001.144/0200
11.5 mm	3.95 mm	6.5 mm	-	5.46.001.145/0200
11.5 mm	4.45 mm	7.0 mm	-	5.46.001.146/0200
11.5 mm	5.50 mm	8.5 mm	-	5.46.001.141/0200
11.5 mm	7.15 mm	9,7 mm	yes	5.46.001.147/0200
11.5 mm	9.95 mm	12,5 mm	-	5.46.001.148/0200
11.5 mm	10.30 mm	12.85 mm	-	5.46.001.142/0200
14.5 mm	3.00 mm	5.55 mm	-	5.46.001.163/0200
14.5 mm	3.45 mm	6.0 mm	-	5.46.001.164/0200
14.5 mm	3.95 mm	6.5 mm	-	5.46.001.165/0200
14.5 mm	4.45 mm	7.0 mm	-	5.46.001.166/0200
14.5 mm	7.15 mm	9,7 mm	yes	5.46.001.167/0200
14.5 mm	9.95 mm	12,5 mm	-	5.46.001.168/0200
19.0 mm	3.00 mm	5.55 mm	-	5.46.001.183/0200

PCB KEY SWITCHES

MICON 5 - PLUNGER ROUND, NOT ILLUMINABLE

– Table (continued) –
MICON 5 - Plunger opaque, round, not illuminable

→ Plunger diameter/size ST	Length of plunger L	Overall height GH with embossing	9.2 mm compatible	Order no.
19.0 mm	3.45 mm	6.0 mm	-	5.46.001.184/0200
19.0 mm	3.95 mm	6.5 mm	-	5.46.001.185/0200
19.0 mm	4.45 mm	7.0 mm	-	5.46.001.186/0200
19.0 mm	7.15 mm	9,7 mm	yes	5.46.001.187/0200
19.0 mm	9.95 mm	12,5 mm	-	5.46.001.188/0200

Can only be combined with MICON 5 version Standard (red bubble)

PCB KEY SWITCHES

MICON 5 - PLUNGER ROUND, RING ILLUMINATION



MICON 5 Plungers round, ring illumination



→ A MICON system design with ring illumination is only possible with the type height 9.70 mm. We recommend back printing the ring illumination area with a diffusing ink. For the actuating area, back printing with an opaque ink is recommended.

Typical system design with 9.70 mm height, round plunger, opaque, ring illumination

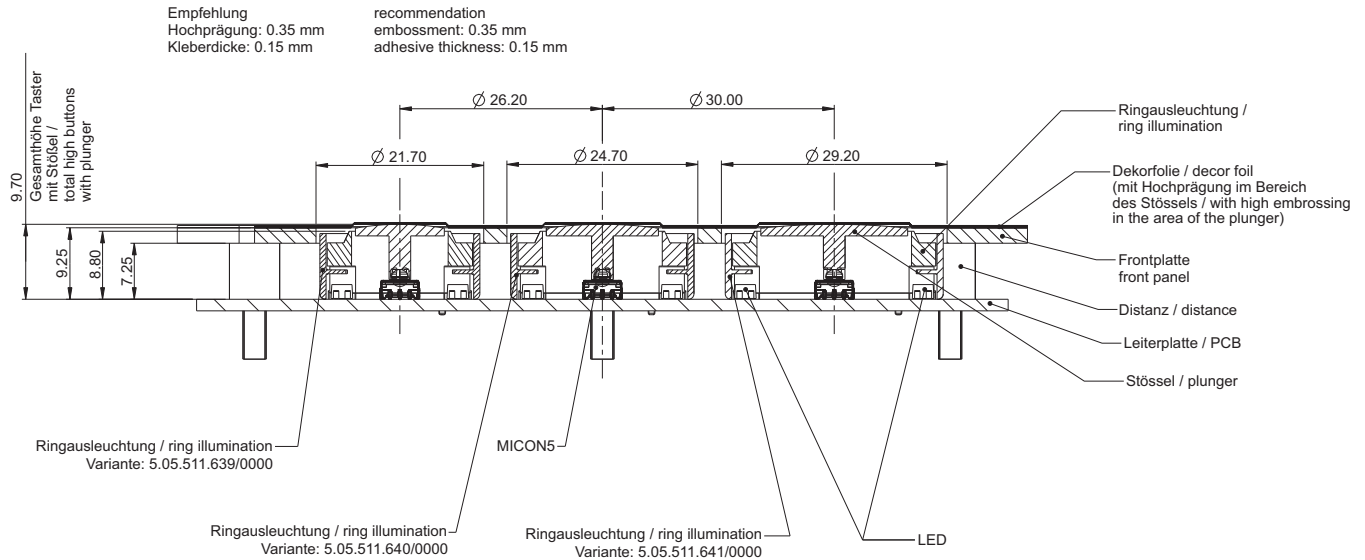

Hole pattern of PCB

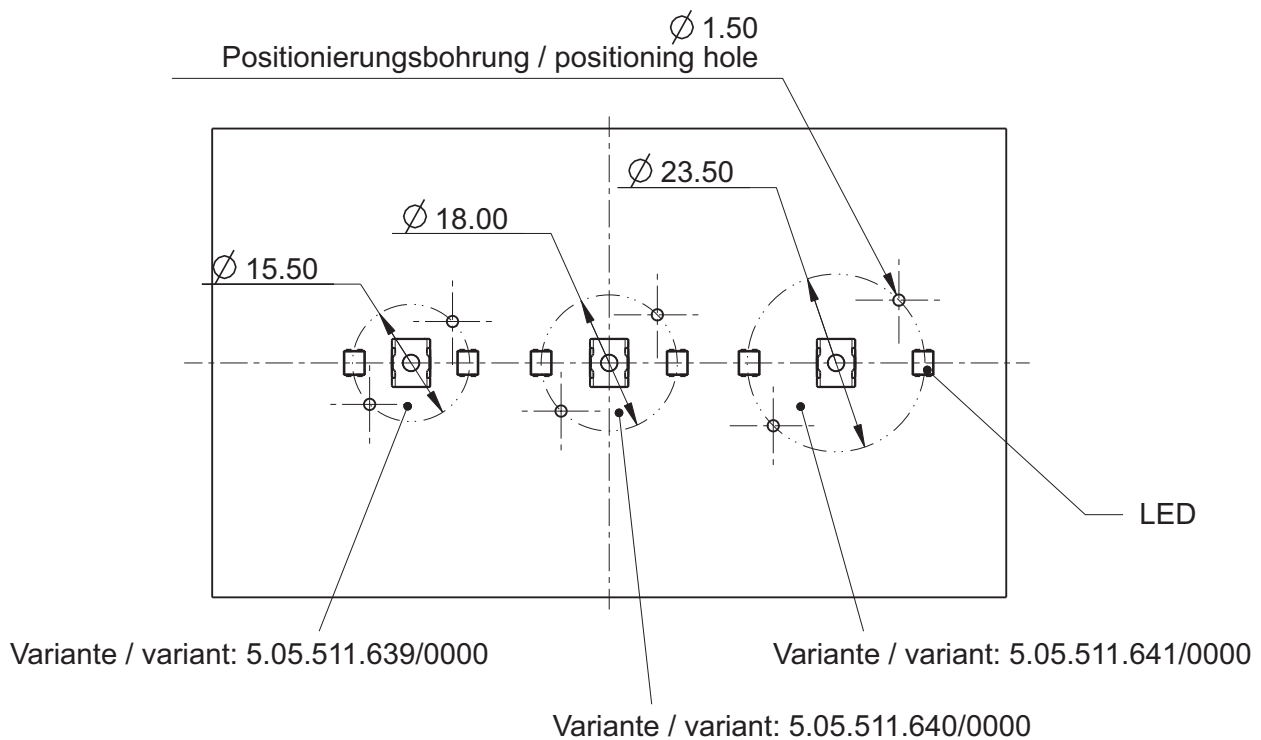

PCB KEY SWITCHES

MICON 5 - PLUNGER ROUND, RING ILLUMINATION



MICON 5 Plunger round, ring illumination



→ Plunger diameter non-illuminated	Diameter ring illumination RA	9.2 mm compatible	Overall height GH with embossing	Order no.
11.50 mm	20.70	yes	9.70 mm	5.05.511.641/0000
14.50 mm	23.70	yes	9.70 mm	5.05.511.640/0000
19.00 mm	28.20	yes	9.70 mm	5.05.511.639/0000

Plunger round, not illuminable is included in delivery.

MICON 5 Plungers square, illuminable

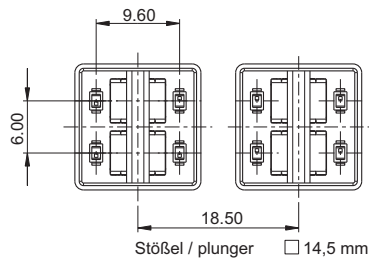

Pic. with 4 LED OSRAM LO M676-Q1R1-24

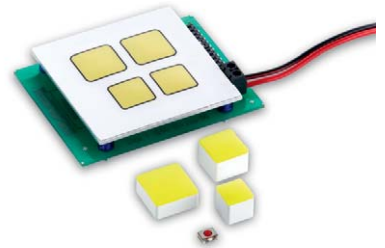

→ Description

- A - Height of key switch: SMT = 3.85 mm, THT = 3.80 mm
 - B - Width of plunger (11 x 11 mm, 14,5 x 14,5 mm or 18 x 18 mm)
 - D - GH - FP - 0.5 mm (= embossing height 0.35 mm + glue height 0.15 mm)
 - FD - Front panel cut-out: B + 1 mm
 - FP - Thickness of front plate
 - GH - Overall height: A + 5.75 mm
 - KS - Glue strip min. 3 mm
 - R - Grid size: FD + KS
- The plungers can only be combined with MICON 5 version Standard (red bubble).

Technical Data

→ General information

Overall height GH	see order block
Color of lens	see order block

→ Other specifications

ROHS compliant	yes
REACH compliant	yes

PCB KEY SWITCHES

MICON 5 - PLUNGER SQUARE, ILLUMINABLE

Typical system design under overlay, square plungers, illuminable

Aufbau:
Hochprägung 0.35 mm
Klebedicke 0.15 mm
assembly:
embossment: 0.35 mm
adhesive thickness: 0.15 mm

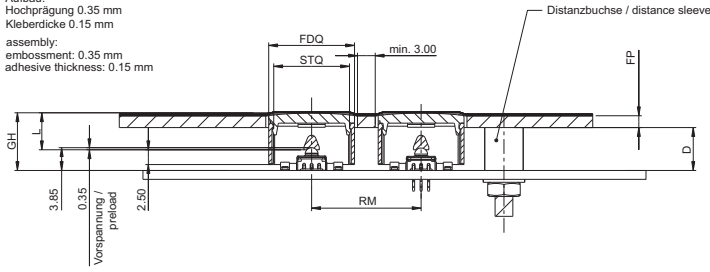

D - Distanzlänge / distance length $D = GH - FP - 0.5$
(Prägehöhe / embossing height
+ Klebedicke / adhesive thickness)

L - Stößellänge / tappet length

STQ - Breite quadratischer Stößel / width square tappet

FDQ - Quadratischer Frontplattendurchbruch /
square front panel breakthrough $FDQ = STQ + 1\text{ mm}$

FP - Frontplattenstärke / Panel thickness

RM - Rastermaß / grid dimensions $RM = FDQ + \text{min. } 3\text{ mm}$

RAFI standard system design, 9.70 mm height, square plunger, illuminable

Aufbau:
Hochprägung 0.35 mm
Klebedicke 0.15 mm
assembly:
embossment: 0.35 mm
adhesive thickness: 0.15 mm

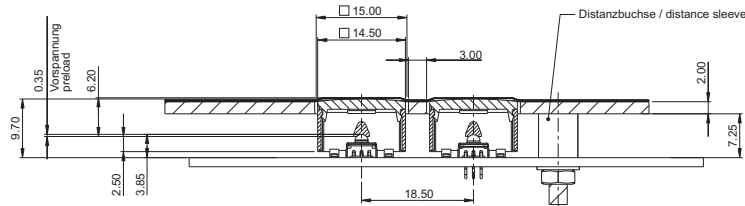

Possible arrangement of LEDs with square plunger, illuminable

View without frontpanel, overlay and lens

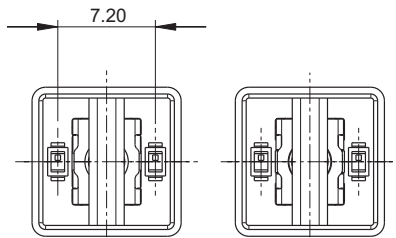

Stößel / plunger □ 11 mm

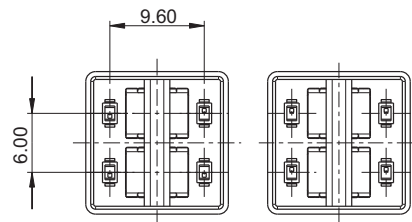

Stößel / plunger □ 14,5 mm

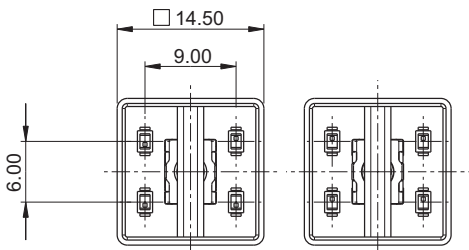

Stößel / plunger □ 14,5 mm

4

MICON

MICON 5 Plunger square, illuminable, 11 x 11 mm

Technical data see page 4 - 17



Platzierungsmöglichkeiten der LED's
(Ansicht ohne Frontplatte, Folie und Blende)
placement options of the LEDs
(view without front panel, foil and lens)

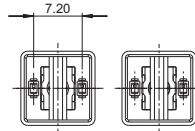

Stößel / plunger □ 11 mm

Pic. with 2 LED OSRAM LO M676-Q1R1-24

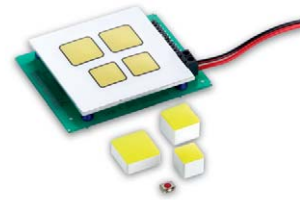

→ Overall height GH	Color of lens	Order no.
9.70 mm	red	5.05.511.470/2300
12.50 mm	red	5.05.511.471/2300
9.70 mm	yellow	5.05.511.470/2400
12.50 mm	yellow	5.05.511.471/2400
9.70 mm	green	5.05.511.470/2500
12.50 mm	green	5.05.511.471/2500
9.70 mm	blue	5.05.511.470/2600
12.50 mm	blue	5.05.511.471/2600
9.70 mm	white	5.05.511.470/2200
12.50 mm	white	5.05.511.471/2200

Can only be combined with MICON 5 version Standard (red bubble)

MICON 5 Plunger square, illuminable, 14.5 x 14.5 mm

Technical data see page 4 - 17

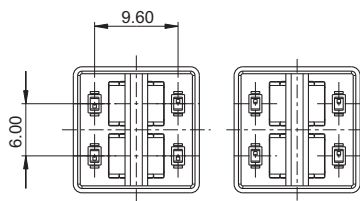

Stößel / plunger □ 14,5 mm

Pic. with 4 LED OSRAM LO M676-Q1R1-24

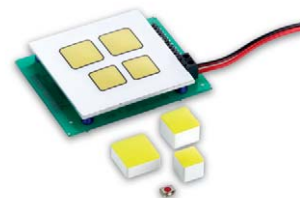

PCB KEY SWITCHES

MICON 5 - PLUNGER SQUARE, ILLUMINABLE

– Table (continued) –

MICON 5 - Plunger square, illuminable, 14.5 x 14.5 mm

→ Overall height GH	Color of lens	Order no.
9.70 mm	red	5.05.511.475/2300
12.50 mm	red	5.05.511.476/2300
9.70 mm	yellow	5.05.511.475/2400
12.50 mm	yellow	5.05.511.476/2400
9.70 mm	green	5.05.511.475/2500
12.50 mm	green	5.05.511.476/2500
9.70 mm	blue	5.05.511.475/2600
12.50 mm	blue	5.05.511.476/2600
9.70 mm	white	5.05.511.475/2200
12.50 mm	white	5.05.511.476/2200

Can only be combined with MICON 5 version Standard (red bubble)

MICON 5 Plunger square, illuminable, 18 x 18 mm

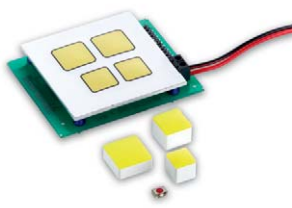

Technical data see page 4 - 17



Platzierungsmöglichkeiten der LED's
(Ansicht ohne Frontplatte, Folie und Blende)
placement options of the LEDs
(view without front panel, foil and lens)

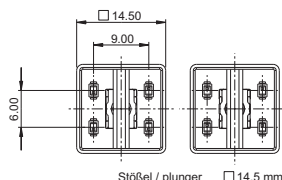

→ Overall height GH	Color of lens	Order no.
9.70 mm	red	5.05.511.480/2300
12.50 mm	red	5.05.511.481/2300
9.70 mm	yellow	5.05.511.480/2400
12.50 mm	yellow	5.05.511.481/2400
9.70 mm	green	5.05.511.480/2500
12.50 mm	green	5.05.511.481/2500
9.70 mm	blue	5.05.511.480/2600
12.50 mm	blue	5.05.511.481/2600
9.70 mm	white	5.05.511.480/2200
12.50 mm	white	5.05.511.481/2200

4

MICON

PCB KEY SWITCHES

MICON 5 - PLUNGER SQUARE, ILLUMINABLE

– Table (continued) –
MICON 5 - Plunger square, illuminable, 18 x 18 mm

Can only be combined with MICON 5 version Standard (red bubble)

PCB KEY SWITCHES

MICON 5 - SQUARE PLUNGERS, SPOT-ILLUMINATION



MICON 5 Plungers square, spot-illumination



Technical Data

→ **General information**

Overall height GH with embossing	9.70 mm
Color of lens	white
Dimensions	see order block

→ **Other specifications**

ROHS compliant	yes
REACH compliant	yes

RAFI standard system design, 9.70 mm height, square plunger, spot-illumination

Aufbau:
 Hochprägung 0.35 mm
 Kleberdicke 0.15 mm
 assembly:
 embossment: 0.35 mm
 adhesive thickness: 0.15 mm

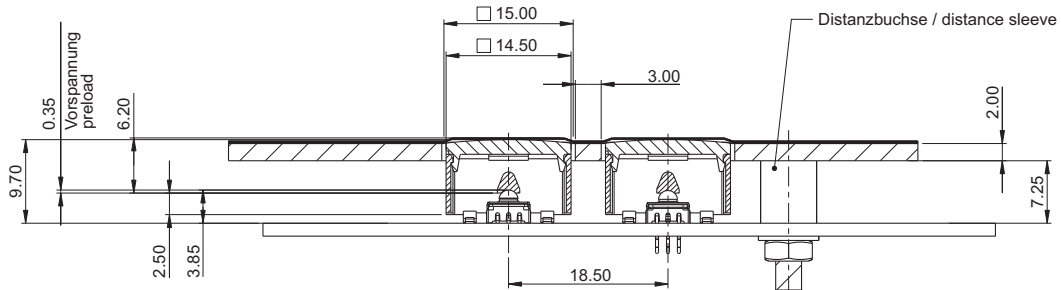

Possible arrangement of LEDs with square plunger, spot illumination, 14,5 x 14,5 mm

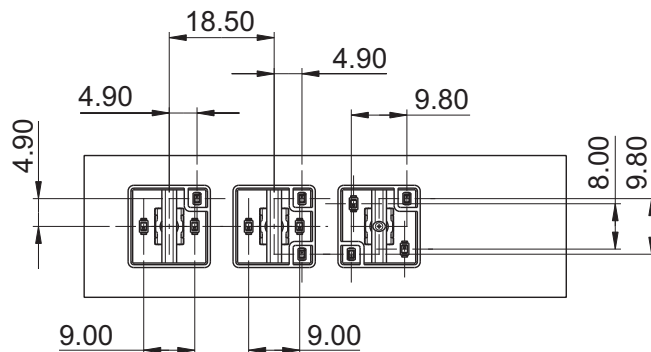

Possible arrangement of LEDs with square plunger, spot illumination, 18 x 18 mm

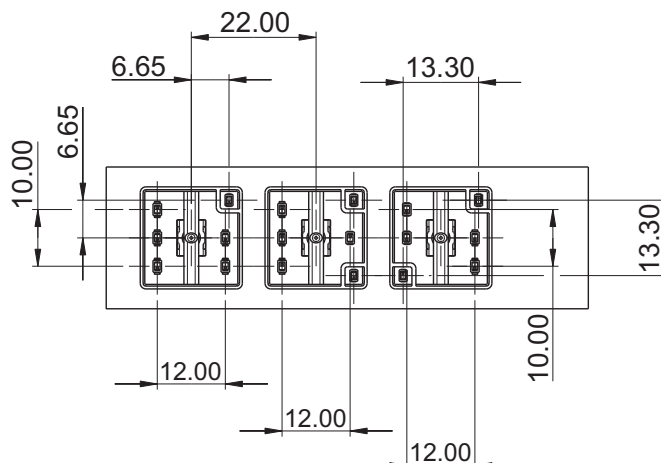

PCB KEY SWITCHES

MICON 5 - SQUARE PLUNGERS, SPOT-ILLUMINATION



MICON 5 Plunger square, spot-illumination, plunger 14.5 x 14.5 mm

Technical data see page 4 - 22



→ Overall height GH with embossing	Spot-illumination	Color of lens	Dimensions	Order no.
9.70 mm		white	14.5 x 14.5	5.05.511.649/2200
9.70 mm		white	14.5 x 14.5	5.05.511.650/2200
9.70 mm		white	14.5 x 14.5	5.05.511.651/2200

4



MICON 5 Plunger square, spot-illumination, plunger 18 x 18 mm

Technical data see page 4 - 22



→ Overall height GH with embossing	Spot-illumination	Color of lens	Dimensions	Order no.
9.70 mm		white	18 x 18	5.05.511.658/2200
9.70 mm		white	18 x 18	5.05.511.659/2200
9.70 mm		white	18 x 18	5.05.511.660/2200

PCB KEY SWITCHES

MICON 5 - SQUARE PLUNGERS, SPOT-ILLUMINATION



GET IN TOUCH

The uniqueness of the moment

Whenever a pushbutton or switch made by RAFI is used, the company's technology ensures that proper contact is made. For over 100 years now, we have driven innovation in human-machine communication and set standards across the globe. From operating elements and highly intelligent data entry systems to complete custom solutions from one source – all of our products are developed to meet the requirements of our long-standing customers. The results are excellent: close business relationships, innovative products and motivated employees.

Visit our website to learn more about RAFI.

www.rafi.de

RAFI

4

MICON

PCB KEY SWITCHES

MICON 5 - PLUNGER FOR SIGNAL INDICATOR



MICON 5 Plungers for signal indicator

Technical Data

→ **General information**

Overall height GH with embossing	9.70 mm
Lens color	white
Dimensions	see order block

→ **Other specifications**

ROHS compliant	yes
REACH compliant	yes

PCB KEY SWITCHES

MICON 5 - PLUNGER FOR SIGNAL INDICATOR

RAFI standard system design, 9.70 mm height, signal indicator

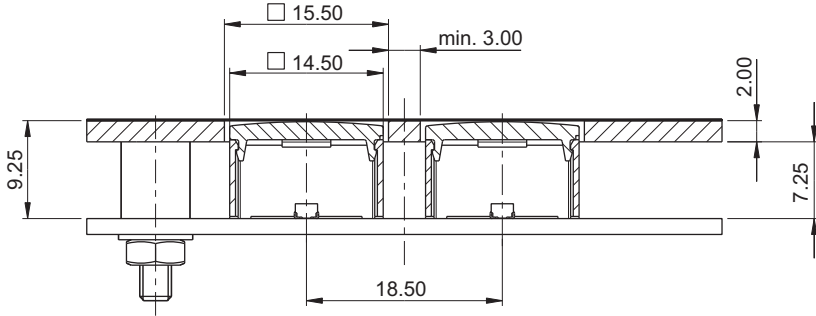

Possible arrangement of LEDs with signal indicator

LED Platzierung mit Leuchtfeld 14.5x14.5
LED placement with light field 14.5 x14.5

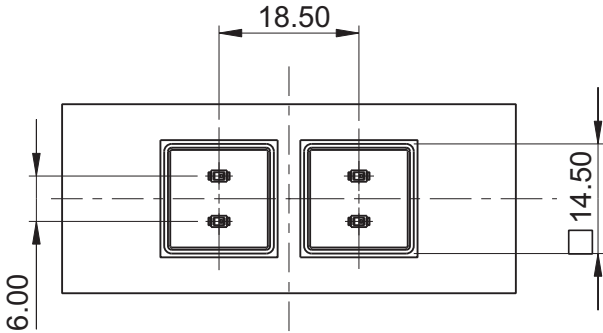

PCB KEY SWITCHES

MICON 5 - PLUNGER FOR SIGNAL INDICATOR



MICON 5 Plunger for signal indicator, 1-module

Technical data see page 4 - 26

LED Platzierung mit Leuchtfeld 11x11
LED placement with light field 11x11

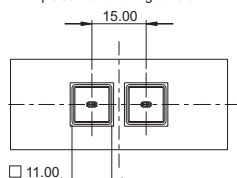

LED Platzierung mit Leuchtfeld 14.5x14.5
LED placement with light field 14.5 x14.5

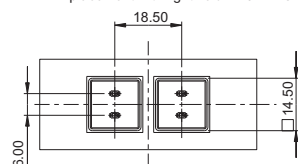

LED Platzierung mit Leuchtfeld 18x18
LED placement with light field 18x18

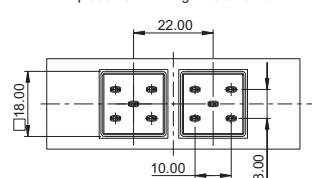

→ Overall height GH with embossing	Lens color	Dimensions	Order no.
9.70 mm	white	11 x 11 mm	5.05.005.182/2200
9.70 mm	white	14.5 x 14.5 mm	5.05.005.175/2200
9.70 mm	white	18 x 18 mm	5.05.005.176/2200

MICON 5 Plunger for signal indicator, 2-module

Technical data see page 4 - 26

LED Platzierung mit Leuchtfeld 14.5x29
LED placement with light field 14.5 x29

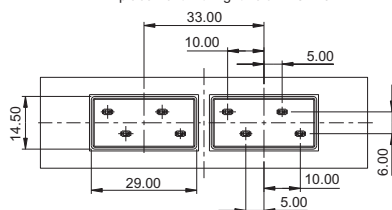

LED Platzierung mit Leuchtfeld 18x36
LED placement with light field 18x36

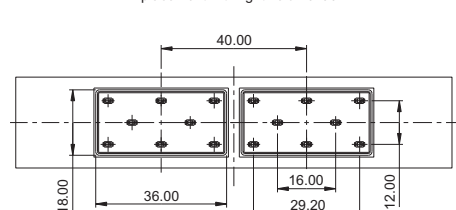

→ Overall height GH with embossing	Lens color	Dimensions	Order no.
9.70 mm	white	14.5 x 29 mm	5.05.005.177/2200
9.70 mm	white	18 x 36 mm	5.05.005.178/2200

4



MICON

Redundant system design with illuminable plungers MICON 1.14.002.201, 1.5 N

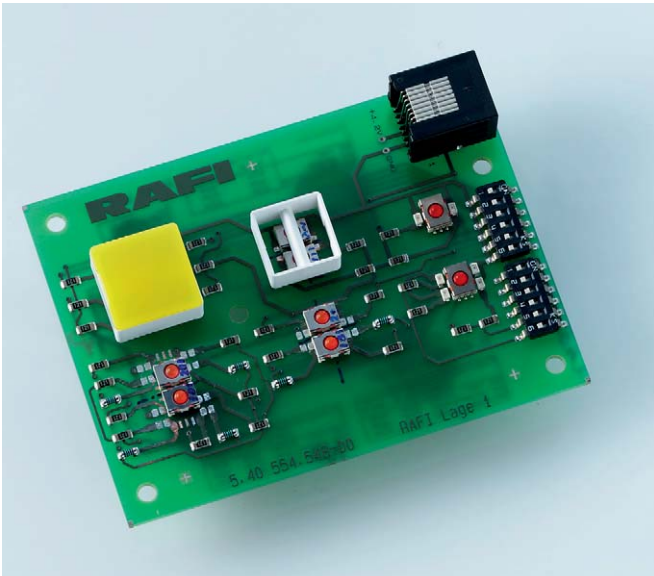

The tactile switch type **1.14.002.201/0000** is designed only for use in a **redundant system** with another SMT switch of standard height. For a redundant system design, the plunger sizes 14.5 x 14.5 mm or 18 x 18 mm must be used.

View without front panel, overlay and lens

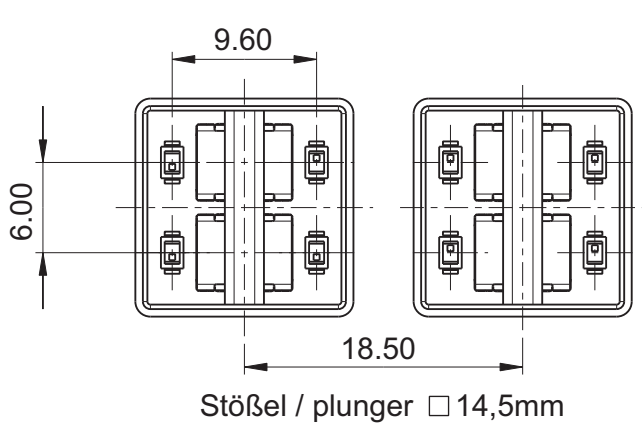

Plunger 14,5 x 14,5 mm

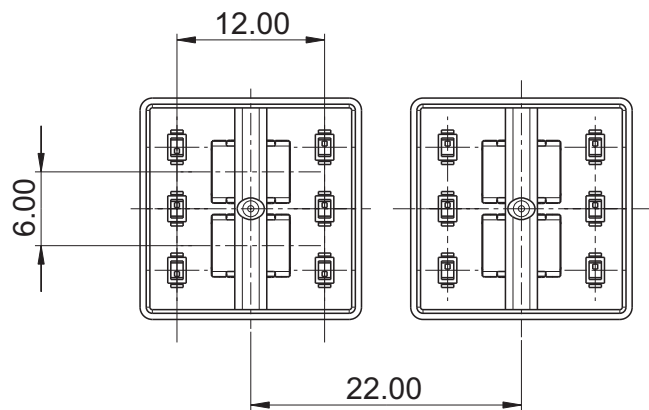

Plunger 18 x 18 mm

PCB KEY SWITCHES

MICON 5 - PLUNGER FOR SIGNAL INDICATOR

Typical system design RK 90 degree of protection IP 65

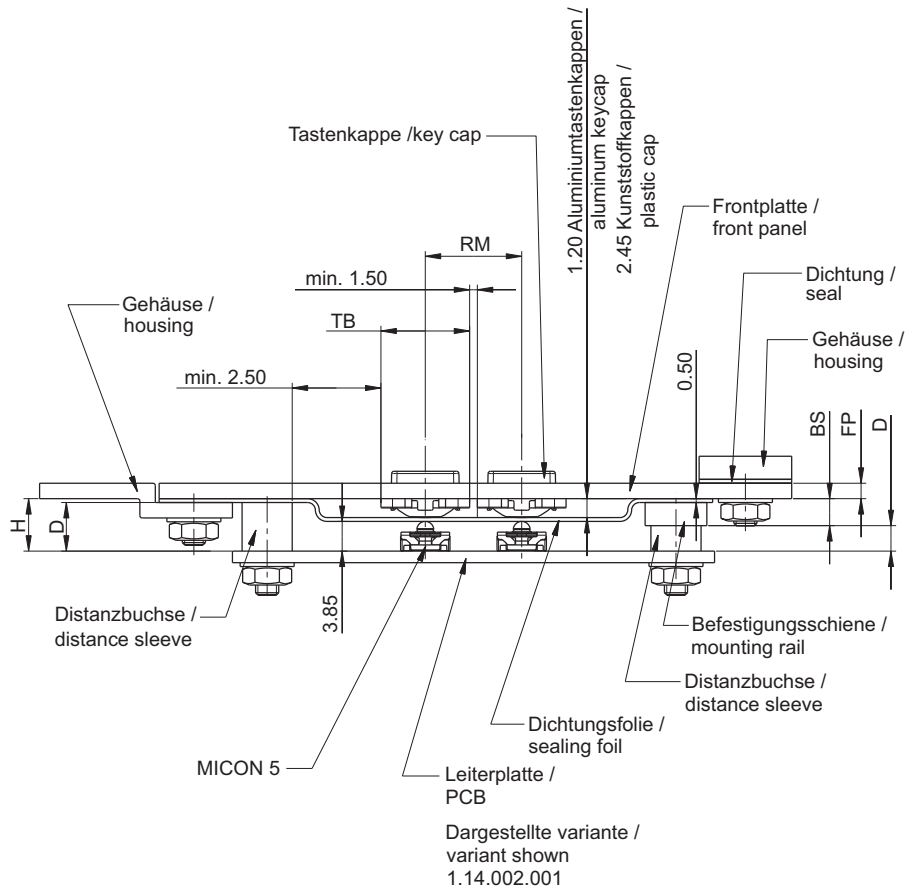

4

Typical system design RK 90 degree of protection IP 40

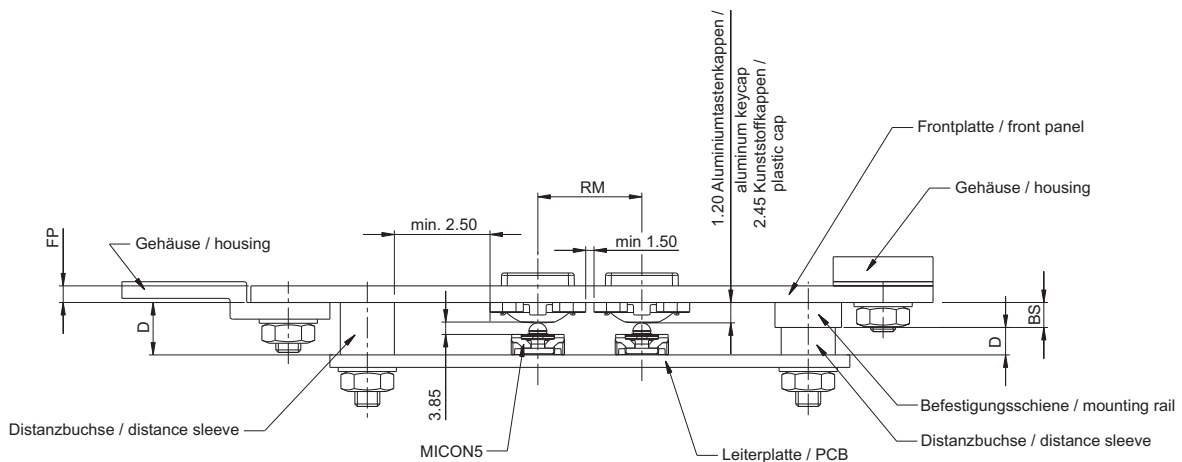

PCB KEY SWITCHES

RACON - TACTILE SWITCHES

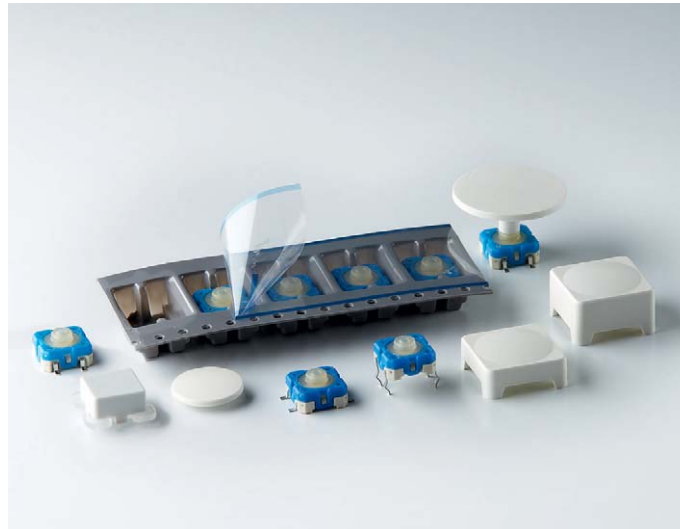

RACON

Tactile switches

RACON tactile switches distinct key click, excellent switching reliability. For use under an overlay or with RK 90 keycaps. Print and SMD versions available (suitable for automatic assembly). All products are RoHS compliant.

4

RACON

PCB KEY SWITCHES

RACON - TACTILE SWITCHES

Content

RACON 8 - Tactile switches	4 - 33
RACON 8 - Tactile switch, THT outward	4 - 37
RACON 8 - Tactile switch, THT inward	4 - 37
RACON 8 - Tactile switch, SMT gullwing (Z) terminals	4 - 38
RACON 12 - Tactile switches	4 - 39
RACON 12 - Tactile switch solder terminals for PCB, outward	4 - 43
RACON 12 - Tactile switch solder terminals for PCB, inward	4 - 43
RACON 12 - Tactile switch SMT gullwing (Z) terminals	4 - 44
RACON 12 V - Tactile switches with vertical adapter	4 - 45
RACON 12 V - Tactile switch with vertical adapter	4 - 46
RACON 12 i - Tactile switches	4 - 47
RACON 12 i - Tactile switch	4 - 48
RACON - Special accessories	4 - 49
Plunger round	4 - 49
Square plunger for membrane data entry system	4 - 51
RK 90 II - Key cap system for RACON 12 with individual sealing	4 - 52
RK 90 II - Sealing frame	4 - 53

RACON 8 Tactile switches

→ RACON 8 tactile switches offer an extremely high switching reliability while needing very little space. They can be arranged as single keys, in rows or key blocks.

When arranged under an overlay, RACON key switches should be combined with plungers.

The features at a glance:

- Suitable for the most common soldering methods
 - Wave soldering bath for THT versions
 - Reflow soldering for SMT version
 - Vapour phase soldering for SMT versions
 - Manual soldering
- SMT version suitable for processing with an automatic SMT assembly machine
- IMDS listed

You can download actual product information from our internet site www.rafi.de / Catalogues and Downloads

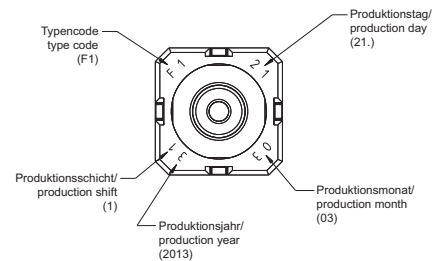



Technical Data

→ Dimensions	
Length of housing	8.4 mm
Width of housing	8.4 mm
Height of housing	see order block
→ Mechanical design	
Mounting	soldering
Terminals	see order block
Contact system	snap-action contact
Contact arrangement	1 NO
Contact materials	Au
Illumination	no
→ Mechanical characteristics	
Switching travel	0.34 ^{±0.1} mm
→ Electrical characteristics	
Rated voltage min.	0.02 V
Rated voltage max.	35 V
Rated current min.	0.01 mA
Rated current max.	100 mA
Rated power max. (ohmic load)	1 W
Contact resistance when new max.	100 mΩ
Insulation resistance	10 ⁹ Ω
→ Other specifications	
Ambient temp. operating min.	-40 °C
Ambient temp. operating max.	+90 °C
Resistance to environment	DIN EN 60068-2 -14,-30,-33 and -78
Operating life	1,000,000
Solderability / Solder heat resistance	see order block
Flammability of materials	UL 94 HB
Packing	see order block
Produkt type	see order block
ROHS compliant	yes
REACH compliant	yes

PCB KEY SWITCHES

RACON 8 - TACTILE SWITCHES

Accessories RACON 8 - Tactile switch

→ Description	Photo	Order no.	Additional accessories see page
Spacer, round, length 6.25 mm, red		5.30.759.034/0000	2 - 265, 4 - 97, 5 - 32
Plunger round		5.46.167.311/0209	4 - 49
RK 90 - Keycap body, for lenses 9 x 9 mm		5.55.103.265/1013	4 - 110

For other plungers, refer to the chapter „RACON special accessories“; for keycaps, refer to the chapter „RK 90“

RACON 8, Typical system assembly with plunger under overlay

THT terminal outward

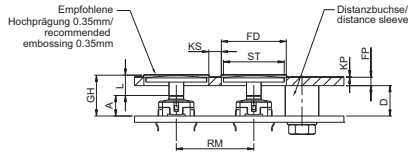

THT terminal inward

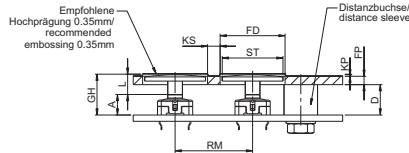

SMT gullwing terminal

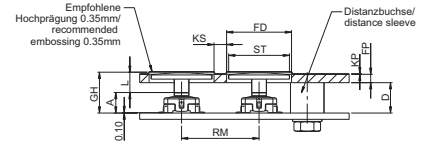

Variable Declaration

THT terminal inward and outward

SMT terminal

A	Height of key switch	$A = 4.90 \pm 0.1 \text{ mm}$	
D	Length of spacer $D = GH - KP - FP$		
FD	Front panel cut-out $FD = ST + 1 \text{ mm}$		
FP	Front panel thickness		
GH	Overall height	$GH = A + L$	$GH = A + L + 0.1 \text{ mm}$
KP	Thickness of overlay + embossing		
KS	Glue webs for overlay, min. 3 mm		
L	Length of plunger	$L = GH - A$	$L = GH - A - 0.1 \text{ mm}$
RM	Key grid		
ST	Diameter of plunger		

RACON 8, Standard system assembly

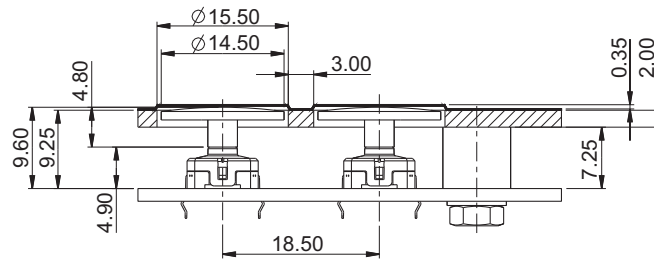

RACON 8, Lowest system assembly

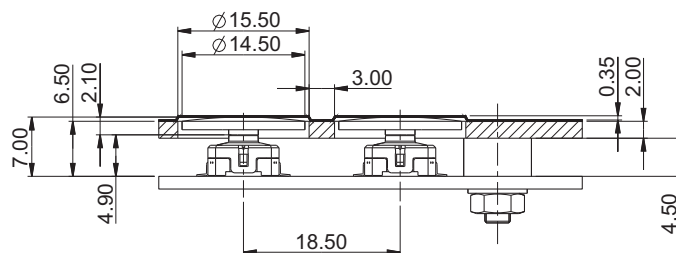

PCB KEY SWITCHES

RACON 8 - TACTILE SWITCHES

RACON 8, PCB hole pattern, smallest grid

THT terminal outward

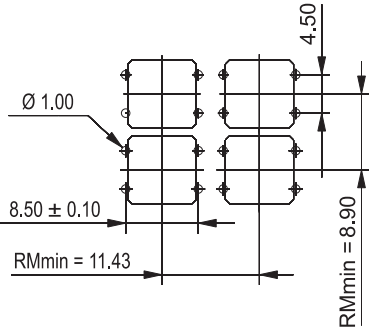

view on component side

THT terminal inward

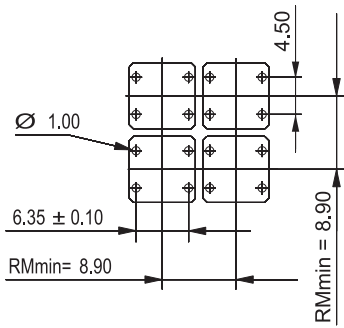

view on component side

SMT gullwing terminal

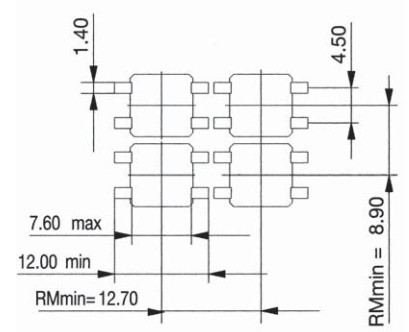

view on component side

RACON 8, SMT terminal, tape and reel

Circuit diagram RACON 8

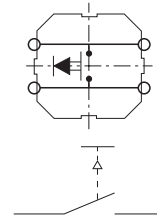
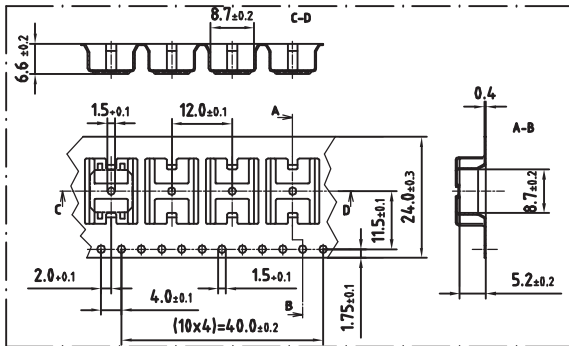

Switching symbols acc. to IEC 60 617 form X (twice interrupting)

4

Typical force travel diagram

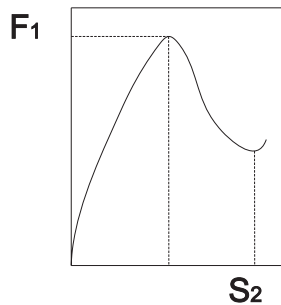

Operating force F1 and switching travel S2 see order block

RACON

RACON 8 Tactile switch, THT outward

Technical data see page 4 - 33

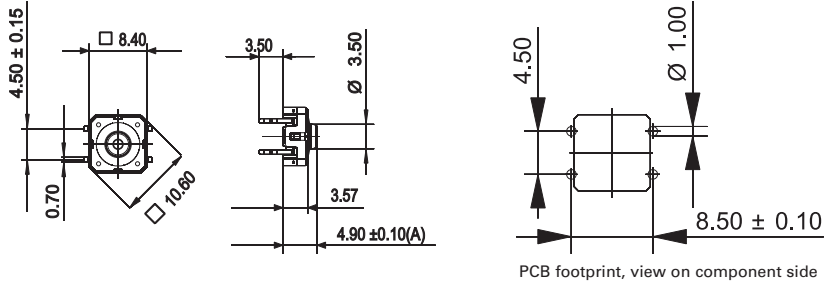

→ Produkt type	Terminals	Operating force	Solderability / Solder heat resistance	Packing	Order no.
A1	THT outward	3.3 ^{±0.6} N	DIN EN 60068-2-20	tubes à 60 pieces	1.14.100.501/0000

For keycaps refer to chapter „RK 90“; plungers see „RACON special accessories“

RACON 8 Tactile switch, THT inward

Technical data see page 4 - 33

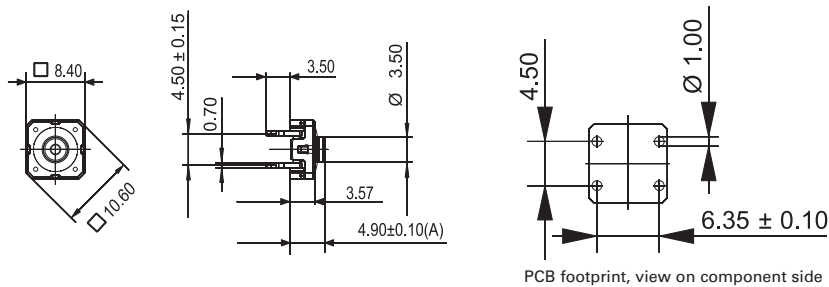

→ Produkt type	Terminals	Operating force	Solderability / Solder heat resistance	Packing	Order no.
B1	THT inward	3.3 ^{±0.6} N	DIN EN 60068-2-20	tubes à 60 pieces	1.14.100.502/0000

For keycaps refer to chapter „RK 90“; plungers see „RACON special accessories“

PCB KEY SWITCHES

RACON 8 - TACTILE SWITCHES



RACON 8 Tactile switch, SMT gullwing (Z) terminals

Technical data see page 4 - 33

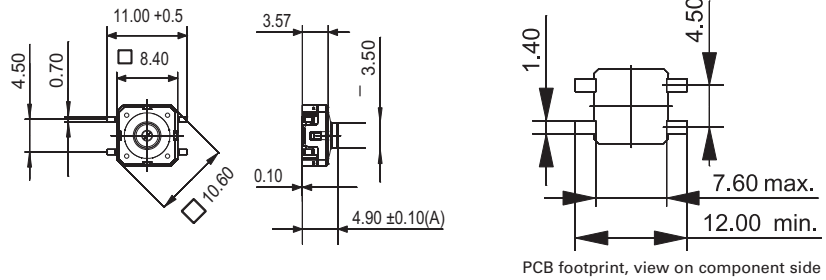

→ Produkt type	Operating force	Switching travel	Operating life	Packing	Solderability / Solder heat resistance	Order no.
C1	3.3 ^{±0.6} N	0.34 ^{±0.1} mm	1,000,000	tape and reel à 1000 pieces	DIN EN 60068-2-58	1.14.100.503/0000
C2	4.8 ^{±0.8} N	0.42 ^{±0.1} mm	1,000,000	tape and reel à 1000 pieces	DIN EN 60068-2-58	1.14.100.603/0000
C4	6.0 ^{±1.0} N	0.47 ^{±0.1} mm	50,000	tape and reel à 1000 pieces	DIN EN 60068-2-58	1.14.100.803/0000

For keycaps refer to chapter „RK 90“; plungers see „RACON special accessories“.

RACON 12 Tactile switches

→ RACON 12 tactile switches offer an extremely high switching reliability while needing very little space. They can be arranged as single keys, in rows or key blocks.

When arranged under an overlay, RACON key switches should be combined with plungers.

The features at a glance:

- Suitable for the most common soldering methods
 - Wave soldering bath for THT versions
 - Reflow soldering for SMT versions
 - Vapour phase soldering for SMT versions
 - Manual soldering
- SMT version suitable for processing with an automatic SMT assembly machine
- IMDS listed

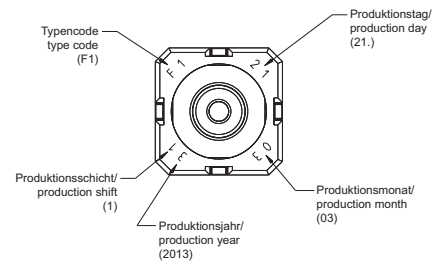

Technical Data

→ Dimensions

Length of housing	12 mm
Width of housing	12 mm
Overall height	see order block

→ Mechanical design

Mounting	soldering
Terminals	see order block
Contact system	snap-action contact
Contact arrangement	1 NO
Contact materials	Au
Illumination	no

→ Mechanical characteristics

Operating force	see order block
Switching travel	see order block

→ Electrical characteristics

Rated voltage min.	0.02 V
Rated voltage max.	35 V
Rated current min.	0.01 mA
Rated current max.	100 mA
Rated power max. (ohmic load)	1 W
Contact resistance when new max.	100 mΩ
Insulation resistance	10 ⁹ Ω





→ Other specifications

Ambient temp. operating min.	-40 °C
Ambient temp. operating max.	+90 °C
Resistance to environment	DIN EN 60068-2 -14,-30,-33 and -78
Operating life	see order block
Solderability / Solder heat resistance	see order block
Flammability of materials	UL 94 HB
Packing	see order block
Produkt code	see order block
ROHS compliant	yes
REACH compliant	yes

PCB KEY SWITCHES

RACON 12 - TACTILE SWITCHES

Accessories RACON 12 - Tactile switch

→ Description	Photo	Order no.	Additional accessories see page
Spacer, round, length 6.25 mm, red		5.30.759.034/0000	2 - 265, 4 - 97, 5 - 32
Square plunger for membrane data entry system		5.46.001.057/0209	4 - 51
Plunger round		5.46.168.050/0209	4 - 50
RK 90 - Keycap body, for lens 1 -module		5.55.103.030/1013	4 - 112

For other plungers, refer to the chapter „RACON special accessories“; for keycaps, refer to the chapter „RK 90“

RACON 12, Typical system assembly with plunger under overlay

THT terminal outward

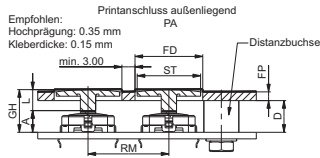

THT terminal inward

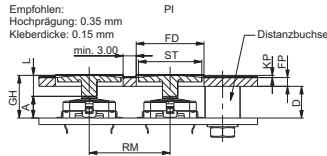

SMT gullwing terminal

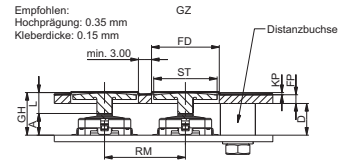

Variable Declaration

THT terminal inward and outward

SMT terminal

A	Height of key switch	$A = 4.90 \pm 0.1 \text{ mm}$
D	Length of spacer	$D = GH - KP - FP$
FD	Front panel cut-out	$FD = ST + 1 \text{ mm}$
FP	Front panel thickness	
GH	Overall height	$GH = A + L$
KP	Thickness of overlay + embossing	
L	Length of plunger	$L = GH - A$
RM	Key grid	
ST	Diameter of plunger	

RACON 12, Standard system assembly

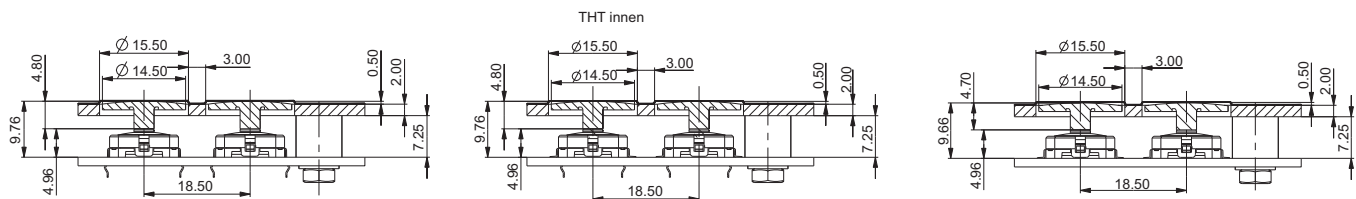

RACON 12, Lowest system assembly

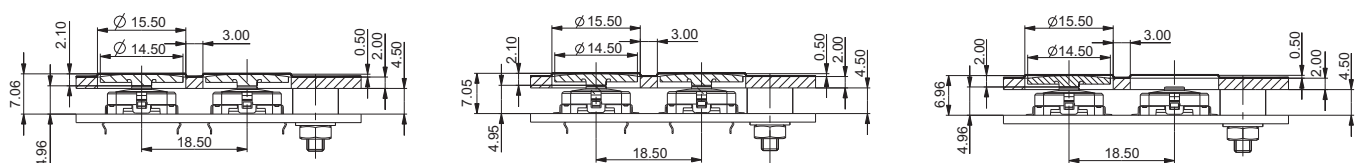

PCB KEY SWITCHES

RACON 12 - TACTILE SWITCHES

RACON 12, PCB hole pattern, smallest grid

THT terminal outward

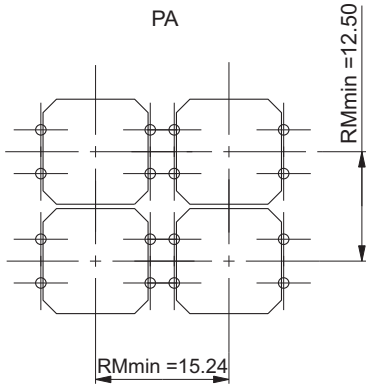

view on component side

THT terminal inward

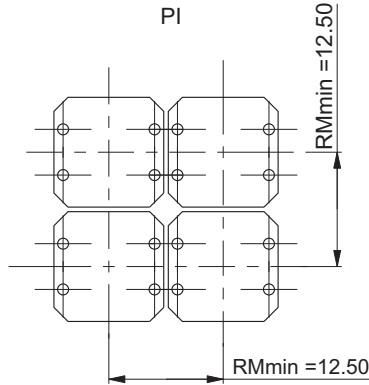

view on component side

SMT gullwing terminal

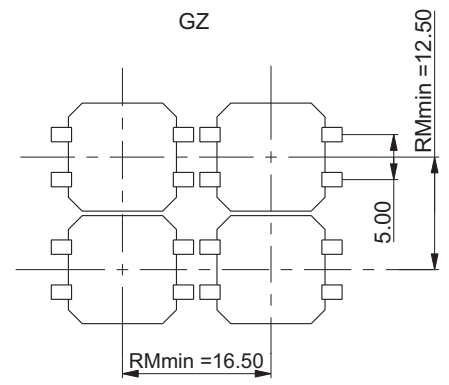

view on component side

RACON 12, SMT terminal, tape and reel

Circuit diagram RACON 12

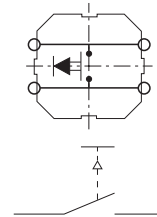
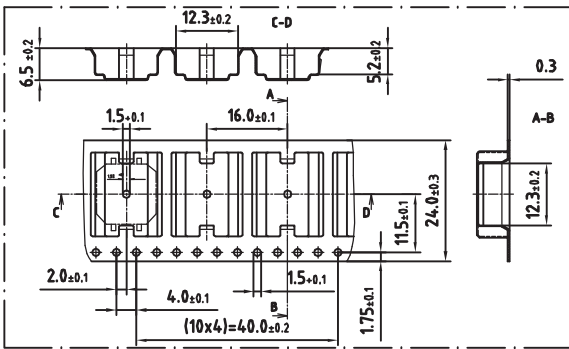

Switching symbols acc. to IEC 60 617 form X (twice interrupting)

4

Typical force travel diagram

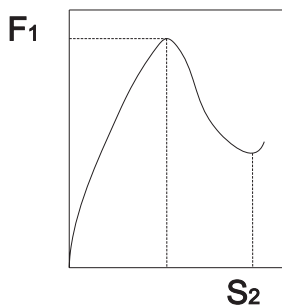

Operating force F1 and switching travel S2 see order block

RACON

RACON 12 Tactile switch solder terminals for PCB, outward

Technical data see page 4 - 39

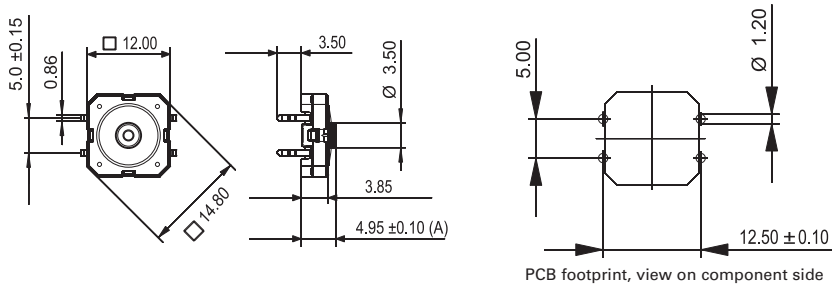

→ Produkt code	Operating force	Switching travel	Operating life	Solderability / Solder heat resistance	Packing	Order no.
A1	3.6 ^{±0.7} N	0.61 ^{±0.1} mm	1,000,000	DIN EN 60068-2-20	tubes à 45 pieces	1.14.001.501/0000

For keycaps refer to chapter „RK 90“, plungers see „RACON special accessories“.

RACON 12 Tactile switch solder terminals for PCB, inward

Technical data see page 4 - 39

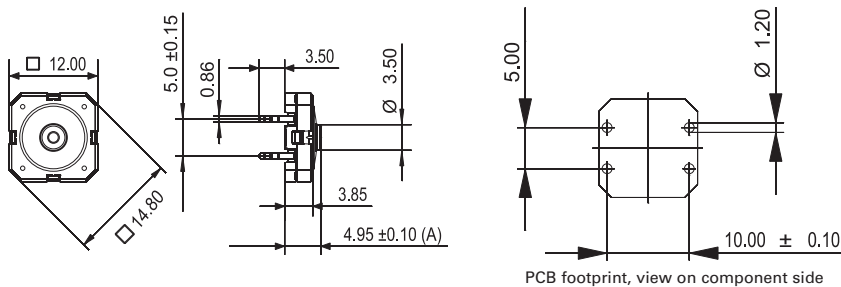

→ Produkt code	Operating force	Switching travel	Operating life	Solderability / Solder heat resistance	Packing	Order no.
B1	3.6 ^{±0.7} N	0.61 ^{±0.1} mm	1,000,000	DIN EN 60068-2-20	tubes à 45 pieces	1.14.001.502/0000

For keycaps refer to chapter „RK 90“, plungers see „RACON special accessories“.

PCB KEY SWITCHES

RACON 12 - TACTILE SWITCHES



RACON 12 Tactile switch SMT gullwing (Z) terminals

Technical data see page 4 - 39

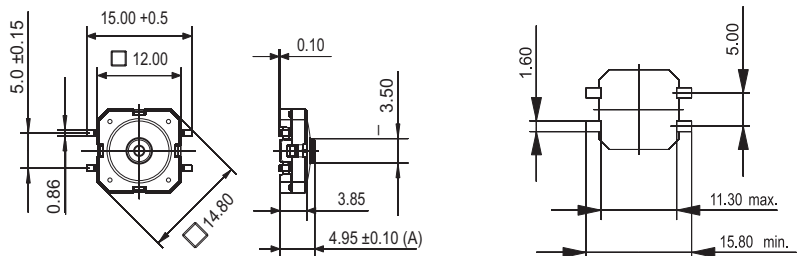

PCB footprint, view on component side

→ Produkt code	Operating force	Switching travel	Operating life	Solderability / Solder heat resistance	Packing	Order no.
C2	2.5 ^{±0.6} N	0.55 mm	1,000,000	DIN EN 60068-2-58	tape and reel à 750 pieces	1.14.001.603/0000
C1	3.6 ^{±0.7} N	0.61 ^{±0.1} mm	1,000,000	DIN EN 60068-2-58	tape and reel à 750 pieces	1.14.001.503/0000
C4	4.7 ^{±0.8} N	0.66 mm	1,000,000	DIN EN 60068-2-58	tape and reel à 750 pieces	1.14.001.803/0000
ZD	6.8 ^{±1.6} N	0.7 ^{±0.1} mm	1,000,000	DIN EN 60068-2-58	tape and reel à 750 pieces	1.14.001.916/0000
ZE	9.7 ^{±2.5} N	0.73 ^{±0.1} mm	65.000	DIN EN 60068-2-58	tape and reel à 750 pieces	1.14.001.920/0000

For keycaps refer to chapter „RK 90“; plungers see „RACON special accessories“.

RACON 12 V Tactile switches with vertical adapter



- The RACON 12 V version can be used, for example, for PC plug-in boards and for measurement and control engineering applications. The vertical mounting adapter (support element) absorbs the operating force so that the pressure on the soldered terminals is reduced. For this mounting arrangement, the key switch is provided with two horizontal terminals on one side.

Technical Data

→ Dimensions

Length	14.5 mm
Width	13.6 mm
Overall height	4.95 mm

→ Mechanical design

Mounting	soldering
Terminals	THT
Contact system	snap-action contact
Contact arrangement	1 NO
Contact materials	Au
Illumination	no

→ Mechanical characteristics

Operating force	3.6 ^{±0.7} N
Switching travel	0.61 ^{±0.1} mm

→ Electrical characteristics

Rated voltage min.	0.02 V
Rated voltage max.	35 V
Rated current min.	0.01 mA
Rated current max.	100 mA
Rated power max. (ohmic load)	1 W
Contact resistance when new max.	100 mΩ
Insulation resistance	10 ⁹ Ω

→ Other specifications

Ambient temp. operating min.	-40 °C
Ambient temp. operating max.	+80 °C
Storage temperature min.	-50 °C
Storage temperature max. (product)	+85 °C
Storage temperature max. (in tube)	+85 °C
Environmental resistance	acc. to IEC 60068-2-14, -30, -33 and -78
Operating life	1,000,000
Solderability / solder heat resistance	DIN EN 60068-2-20
Flammability of materials	UL 94 HB
Packing	in boxes à 100 pieces
Produkt code	F 1
ROHS compliant	yes
REACH compliant	yes

PCB KEY SWITCHES

RACON 12 V - TACTILE SWITCHES



RACON 12 V Tactile switch with vertical adapter

Technical data see page 4 - 45

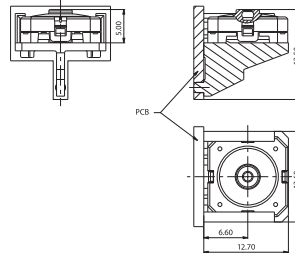

→ Produkt code	Terminals	Contact arrangement	Packing	Order no.
F 1	THT	1 NO	in boxes à 100 pieces	1.14.001.505/0000

Plungers for overall height of 6.5 mm may not be used.

RACON 12 I Tactile switches



→ Application note

Low-profile keyboards with RACON 12 i components should be designed with a grid spacing of 15.24 mm. With this grid, frame webs remain free between the individual keys. The overlay can be glued onto these frame webs; we recommend area embossing over the keys for the overlays. If our RK 90 system design is used, we recommend the 9 x 9 mm keycaps.

Technical Data

→ General information

Color of lens	see order block
Recommended key grid	15.24 x 15.24 mm
Key grid min.	12.5 x 12.5 mm

→ Dimensions

Length	11.35 mm
Width	11.35 mm
Overall height	9.7 mm

→ Mechanical design

Mounting	soldering
Terminals	THT
Contact system	snap-action contact
Contact arrangement	1 NO
Contact materials	Au
Illumination	fully illuminated 2 LED
LED color	see order block
LED type	standard 2 mm

→ Mechanical characteristics

Operating force	3.3 ^{±0.6} N
Switching travel	0.34 ^{±0.1} mm

→ Electrical characteristics

Rated voltage min.	0.02 V
Rated voltage max.	35 V
Rated current min.	0.01 mA
Rated current max.	100 mA
Rated power max. (ohmic load)	1 W
Contact resistance when new max.	100 mΩ
Dielectric strength AC min.	750 V
Insulation resistance	10 ⁹ Ω

→ Electrical characteristics of LED

LED rated current max. I _F at 25 °C	red/green: 30, yellow: 50 mA
LED current reduction beginning with 50 degree C	red: 0.5 mA/degree C, yellow 0.8 mA/degree C
LED wavelength typ.	red 639, green 510-535, yellow 590
LED forward voltage U _F at 20 mA	red: 1.8 V/20 mA, yellow: 1.9 V/20 mA
LED breakdown voltage U _R at 25 °C	min. 5 V/0.1 mA

→ Other specifications

Ambient temp. operating min.	-40 °C
Ambient temp. operating max.	+80 °C
Storage temperature min.	see order block
Storage temperature max. (product)	see order block
Storage temperature max. (in tube)	see order block
Environmental resistance	acc. to IEC 60068-2-14, -30, -33 and -78
Operating life	1,000,000
Solderability / solder heat resistance	DIN EN 60068-2-20
Flammability of materials	UL 94 HB
Packing	tubes à 45 pieces
ROHS compliant	yes
REACH compliant	yes

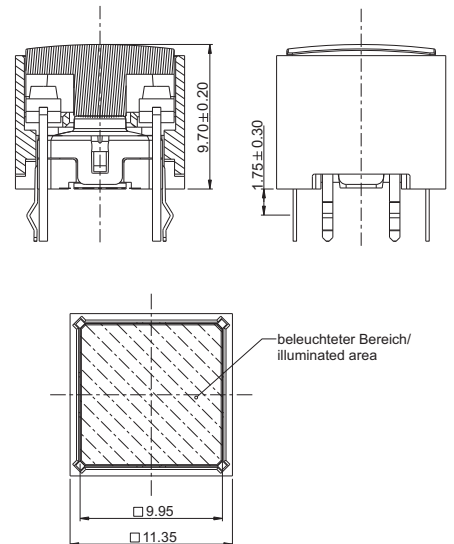

PCB KEY SWITCHES

RACON 12 I - TACTILE SWITCHES

RACON 12i Typical system assembly

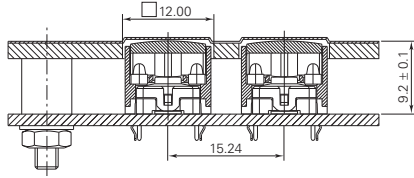

view on component side

Recommended area embossing:
0.35 mm at glue spacer thickness of 0.15 mm

RACON 12i PCB smallest grid

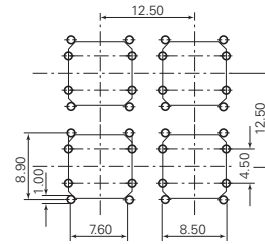

view on component side

LED hole patterns

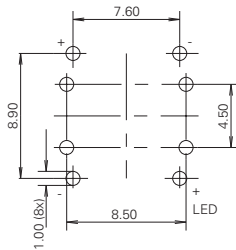

view on component side

RACON 12i Circuit diagram

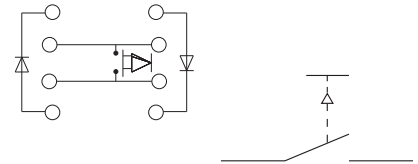

Switching symbols acc. to IEC 60 617 form X
(twice interrupting)

4



RACON 12 i Tactile switch

Technical data see page 4 - 47

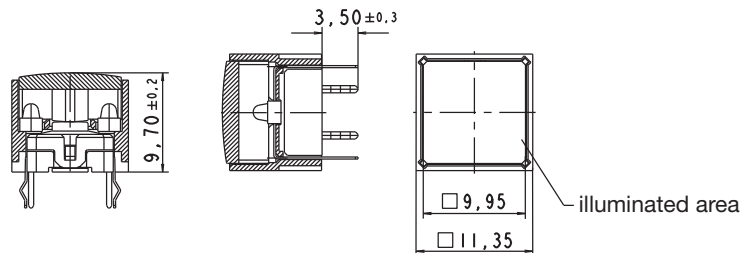

→ Terminals	Contact arrangement	Illumination	Color of lens	LED color	Order no.
THT	1 NO	fully illuminated 2 LED	red	red	1.14.001.551/0000
THT	1 NO	fully illuminated 2 LED	yellow	yellow	1.14.001.553/0000
THT	1 NO	fully illuminated 2 LED	orange	yellow	1.14.001.554/0000
THT	1 NO	fully illuminated 2 LED	green	green	1.14.001.552/0000

If keycaps are used we recommend RK 90 keycaps 9 x 9 mm.

RACON Special accessories

- GH = „L“ length of plunger + „A“ height of key switch (+ 0.1 mm for SMT versions)
Front panel cut-out = size of plunger + 1 mm



Technical Data

→ Dimensions

Length of plunger L	see order block
RACON version	see order block
Plunger diameter/size	see order block

→ Other specifications

ROHS compliant	yes
REACH compliant	yes

Plunger round

Technical data see page 4 - 49

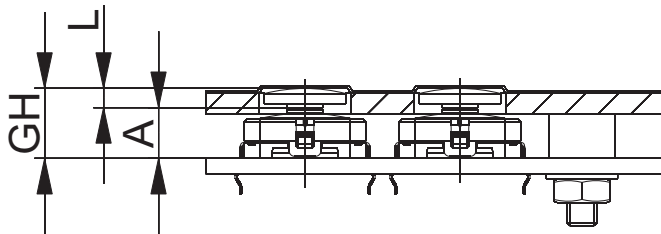

→ Plunger diameter/size	RACON version	Length of plunger L	Order no.
8 mm	RACON 8	1.4 mm	5.46.167.301/0209
8 mm	RACON 8	1.5 mm	5.46.167.102/0209
8 mm	RACON 8	1.6 mm	5.46.167.101/0209
8 mm	RACON 8/12	1.9 mm	5.46.167.090/0209
8 mm	RACON 8/12	2 mm	5.46.167.106/0209
8 mm	RACON 8/12	2.1 mm	5.46.167.107/0209
8 mm	RACON 8/12	4.6 mm	5.46.167.091/0209
8 mm	RACON 8/12	4.7 mm	5.46.167.311/0209
8 mm	RACON 8/12	4.8 mm	5.46.167.094/0209
8 mm	RACON 8/12	7.4 mm	5.46.167.092/0209
8 mm	RACON 8/12	7.5 mm	5.46.167.099/0209
8 mm	RACON 8/12	7.6 mm	5.46.167.096/0209

PCB KEY SWITCHES

RACON 8/12 - SPECIAL ACCESSORIES

– Table (continued) –
Plunger round

→ Plunger diameter/size	RACON version	Length of plunger L	Order no.
11.5 mm	RACON 8	1.4 mm	5.46.167.227/0209
11.5 mm	RACON 8	1.5 mm	5.46.167.061/0209
11.5 mm	RACON 8	1.6 mm	5.46.167.060/0209
11.5 mm	RACON 8/12	2 mm	5.46.167.067/0209
11.5 mm	RACON 8/12	2.1 mm	5.46.167.064/0209
11.5 mm	RACON 8/12	4.6 mm	5.46.167.043/0209
11.5 mm	RACON 8/12	4.7 mm	5.46.167.050/0209
11.5 mm	RACON 8/12	4.8 mm	5.46.167.047/0209
11.5 mm	RACON 8/12	7.5 mm	5.46.167.059/0209
11.5 mm	RACON 8/12	7.6 mm	5.46.167.058/0209
14.5 mm	RACON 8	1.4 mm	5.46.168.227/0209
14.5 mm	RACON 8	1.5 mm	5.46.168.061/0209
14.5 mm	RACON 8	1.6 mm	5.46.168.060/0209
14.5 mm	RACON 8/12	2 mm	5.46.168.067/0209
14.5 mm	RACON 8/12	2.1 mm	5.46.168.064/0209
14.5 mm	RACON 8/12	4.6 mm	5.46.168.043/0209
14.5 mm	RACON 8/12	4.7 mm	5.46.168.050/0209
14.5 mm	RACON 8/12	4.8 mm	5.46.168.047/0209
14.5 mm	RACON 8/12	7.4 mm	5.46.168.044/0209
14.5 mm	RACON 8/12	7.5 mm	5.46.168.059/0209
14.5 mm	RACON 8/12	7.6 mm	5.46.168.058/0209
19 mm	RACON 8	1.5 mm	5.46.169.061/0209
19 mm	RACON 8	1.6 mm	5.46.169.060/0209
19 mm	RACON 8/12	2 mm	5.46.169.067/0209
19 mm	RACON 8/12	2.1 mm	5.46.169.064/0209
19 mm	RACON 8/12	4.7 mm	5.46.169.050/0209
19 mm	RACON 8/12	4.8 mm	5.46.169.047/0209
19 mm	RACON 8/12	7.5 mm	5.46.169.059/0209
19 mm	RACON 8/12	7.6 mm	5.46.169.058/0209

Front panel cut-out = Plunger diameter + 1 mm.

4

RACON

Square plunger for membrane data entry system

Technical data see page 4 - 49

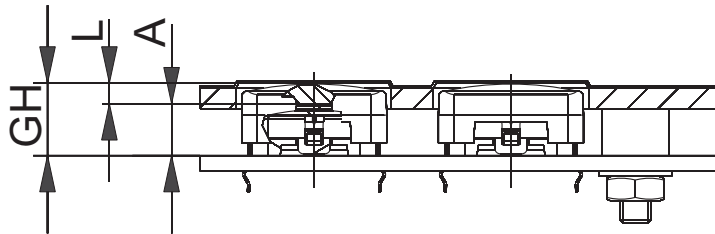

→ Plunger diameter/size	RACON version	Length of plunger L	Order no.
14 x 14 mm	RACON 12 SMT	2 mm	5.46.001.057/0209
14 x 14 mm	RACON 12 SMT	4.7 mm	5.46.001.058/0209
14 x 14 mm	RACON 12 SMT	7.5 mm	5.46.001.059/0209
14 x 14 mm	RACON 12THT	2.1 mm	5.46.001.064/0209
14 x 14 mm	RACON 12THT	4.8 mm	5.46.001.060/0209
14 x 14 mm	RACON 12THT	7.6 mm	5.46.001.063/0209

Front panel cut-out = 15 x 15 mm.

PCB KEY SWITCHES

RK 90 II, KEY CAP SYSTEM FOR RACON 12

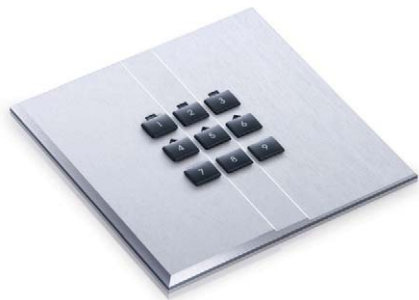

RK 90 II Key cap system for RACON 12 with individual sealing

Technical Data

→ General information

Thickness of front panel	3.00 mm
Light conductor	see order block
Key grid	min. 16.8 x 17.5 mm
Degree of protection	IP65 (DIN EN 60529)

→ Other specifications

ROHS compliant	yes
REACH compliant	yes

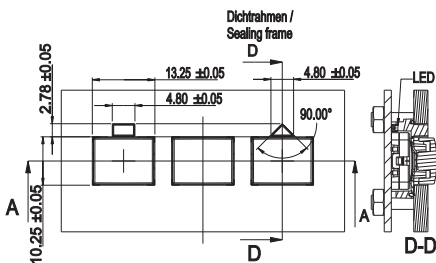

The key cap system RK 90 II has been developed especially for the tactile switch RACON 12. The lenses are snapped onto the sealing frame and then set onto the RACON 12 key switches. The PCB presses this units against the front panel, so they are sealed.

Two versions of the sealing frames are provided with light conductors, either in square or triangle form.

The lenses can be legended directly with laser. For bright letters (see picture) first white lenses are painted in dark, then the letters are cut out of the dark color with laser.

4

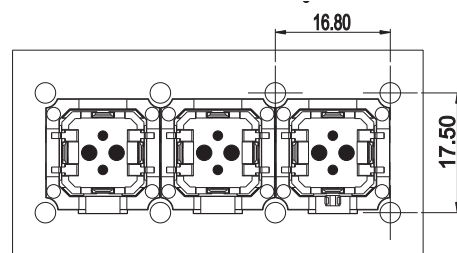
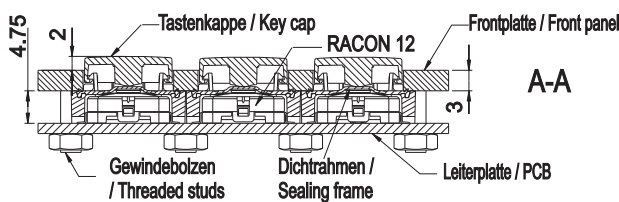

Kleinster Raster / Minimum grid: 16.80 x 17.50

RACON

RK 90 II Sealing frame

Technical data see page 4 - 52



Sealing frame with square light conductor



→ Thickness of front panel	Light conductor	Order no.
3.00 mm	square	5.05.004.901/0000
3.00 mm	dreieckig	5.05.004.902/0000
3.00 mm	-	5.05.004.903/0000

Legended lenses on request.

Lenses:

- Lens RK 90 II, white: 5.46.654.192/0200
- Lens RK 90 II, red: 5.46.654.192/0300
- Lens RK 90 II, yellow: 5.46.654.192/0400
- Lens RK 90 II, green: 5.46.654.192/0500
- Lens RK 90 II, blue: 5.46.654.192/0600
- Lens RK 90 II, grey: 5.46.654.192/0700
- Lens RK 90 II, grey (varnished): 5.46.654.192/6032
- Lens RK 90 II, iron grey (varnished): 5.46.654.192/6033



RF

Tactile switches

RF 15 (15 x 15 mm) and RF 19 (19 x 19 mm) with distinct key click, for use under an overlay or with RK 90 keycaps. Can be fully illuminated. All products are RoHS compliant.

PCB KEY SWITCHES

RF - TACTILE SWITCHES

Content

RF 15 - Tactile switches	4 - 58
RF 15 - Tactile switch, non-illuminated	4 - 60
RF 15 - Tactile switch, fully illuminated with 2 LED	4 - 60
RF 15 - Tactile switch, 1 LED spot-illumination	4 - 61
RF 15 N - Tactile switches	4 - 62
RF 15 N - Tactile switch, non-illuminated	4 - 66
RF 15 R - Tactile switches	4 - 67
RF 15 R - Low tactile switch, non-illuminated	4 - 70
RF 15 R - High tactile switch, non-illuminated	4 - 70
RF 15 R - Low tactile switch, 1 LED spot-illumination	4 - 71
RF 15 R - High tactile switch, 1 LED spot-illumination	4 - 71
RF 15 H - Tactile switches	4 - 73
RF 15 H - Tactile switch, non-illuminated	4 - 76
RF 15 H - Tactile switch, fully illuminated	4 - 76
RF 15 - Signal indicators	4 - 78
RF 15 - Signal indicator, fully illuminated, 1 LED	4 - 80
RF 19 - Tactile switches	4 - 81
RF 19 - Tactile switch, non-illuminated	4 - 84
RF 19 - Tactile switch, fully illuminated with 2 LED	4 - 84
RF 19 - Tactile switch, 1 LED spot-illumination	4 - 85
RF 19 H - Tactile switches	4 - 86
RF 19 H - Tactile switch, non-illuminated	4 - 89
RF 19 H - Tactile switch, fully illuminated	4 - 89
RF 19 - Signal indicators	4 - 91
RF 19 - Signal indicator, 1/2 x 1-module	4 - 93
RF 19 - Signal indicator, 1/2 x 2-module	4 - 93
RF 19 - Signal indicator, 1 x 1-module	4 - 94
RF 19 - Signal indicator, 1 x 2-module	4 - 94
RF 15/19 - Special accessories	4 - 95
RF 15 N - Extension plunger, round head	4 - 95
RF 15 N - Extension plunger, round head, with recess for LED	4 - 96
RF 15 - Keycap, snap-on, for overall height 12.5 mm	4 - 96
Spacer, round	4 - 97
Spacer, triangular	4 - 98
RF 15 N - LED spacer	4 - 99

Specifications LED

LED brightness classes

LEDs are subject to production-related variations in brightness over which we have no control with the manufacturers. It is therefore not possible to arrange a delivery in a specific brightness class, and deviations accordingly do not constitute grounds for complaint regarding our products. The majority of the LEDs we use are delivered from

our suppliers in selected brightness classes. In this case, the brightness class is shown on a label on the switch's rack packaging. Where the lighting is required to have a uniform brightness – for aesthetic reasons, for example – this can be achieved in the system by means of the circuitry (with a series resistance, for example).

3 mm LED

(valid for 25 °C)	Red LED	Green LED	Yellow LED
Max. forward current I _F :	30 mA	30 mA	20 mA
Current reduction from: T ₀ = 50 °C:	approx 0.5 mA/°C	approx 0.5 mA/°C	approx 0.2 mA/°C
Wavelength typ:	635 nm	565 nm	586 nm
Forward voltage U _F /I _F typ:	2 V/10 mA	2 V/10 mA	2 V/10 mA
Reverse voltage U _R /I _F typ:	5 V/100 µA min.	5 V/100 µA min.	5 V/100 µA min.
Ambient temperature, operating:	- 20 °C ... + 80 °C	- 20 °C ... + 80 °C	- 20 °C ... + 80 °C
	Blue LED	White LED	Green LED superbright
Max. forward current I _F :	20 mA	25 mA	30 mA
Current reduction from: T ₀ = 50 °C:	approx 0.6 mA/°C	-	-
Wavelength typ:	470 nm	-	510-545 nm
Forward voltage U _F /I _F typ:	2.7 V/10 mA	3.6 V/20 mA	3.5 V/20 mA
Reverse voltage U _R /I _F typ:	5V/100 µA min.	-	-
Ambient temperature, operating:	- 20 °C ... + 80 °C	- 20 °C ... + 80 °C	-30 °C ... + 100 °C

2 mm LED (full illumination of RF 15/19)

(valid for 25 °C)	Red LED	Green LED	Yellow LED
Max. forward current I _F :	30 mA	30 mA	50 mA
Current reduction from: T ₀ = 50 °C:	0.5 mA/°C	0.5 mA/°C	0.8 mA/°C
Light current I _V /I _F typ:	-	-	250 mIm/20 mA
Wavelength typ:	637 nm	569 nm	590 nm
Forward voltage U _F /I _F typ:	1.8 V/20 mA	2.1 V/10 mA	1.9 V/20 mA
Reverse voltage U _R /I _F typ:	5 V/100 µA min.	5 V/100 µA min.	5 V/100 µA min.
Ambient temperature, operating:	- 55 °C ... + 100 °C	- 40 °C ... + 100 °C	-40 °C ... + 100 °C
	Blue LED	Multi-color LED	
Max. forward current I _F :	30 mA	30 mA	
Current reduction from: T ₀ = 50 °C:	-	approx 0.6 mA/°C	
Light current I _V /I _F typ:	-	-	
Wavelength typ:	464-485 nm	635/565 nm	
Forward voltage U _F /I _F typ:	3.6 V/20 mA	2 V/10 mA	
Reverse voltage U _R /I _F typ:	-	-	
Ambient temperature, operating:	- 20 °C ... + 80 °C	- 20 °C ... + 80 °C	

Calculating the series resistor:

$$R_V = \frac{U_B - U_F}{I_F}$$

Rated power of series:

$$P_V = I_F^2 \times R_V$$

Example for 5 Volt:

$$R_V = \frac{5V - 2,0V}{0,02 A} = 150 \Omega (= \text{standard value})$$

PCB KEY SWITCHES

RF 15 - TACTILE SWITCHES



RF 15 Tactile switches

- Low-profile keyboards with RF 15 components should be designed with a 19.05 mm grid. With this grid, frame webs remain free between the individual keys. The overlay can be glued onto these frame webs; we recommend area embossing over the keys for the overlays.

Technical Data

→ General information

Color of lens	see order block
Recommended key grid	19.05 mm

→ Dimensions

Length	15 mm
Width	15 mm
Overall height	9.7 mm

→ Mechanical design

Mounting	soldering in PCB
Terminals	THT
Contact system	snap-action contact
Contact arrangement	1 NO
Contact materials	see order block
Illumination	see order block
LED color	see order block
LED type	see order block

→ Mechanical characteristics

Operating force max.	2.9 ^{+0.6} N
Switching travel	0.5 ^{+0.2} mm
Robustness max.	with through-plated PCB 100 N

→ Electrical characteristics

Rated voltage min.	Au: 0.02 V, Ag: 3 V
Rated voltage max.	35 V
Rated current min.	Au: 0.01 mA, Ag: 0.1 mA
Rated current max.	Au: 100 mA, Ag: 250 mA
Rated power max. (ohmic load)	Au: 2 W, Ag: 12.5 W
Contact resistance when new max.	100 mΩ
Insulation resistance	10 ⁹ Ω

→ Other specifications

Ambient temp. operating min.	-25 °C
Ambient temp. operating max.	+70 °C
Environmental resistance	acc. to IEC 60068-2-14, -30, -33 and -78
Operating life min. (operations)	1,000,000
Solderability / solder heat resistance	according to DIN EN 60068-2-20
Wave soldering	260 °C max.
Manual soldering	350 °C / 5 sec. max.
ROHS compliant	yes
REACH compliant	yes

PCB KEY SWITCHES

RF 15 - TACTILE SWITCHES



RF 15 Tactile switch, non-illuminated

Technical data see page 4 - 58

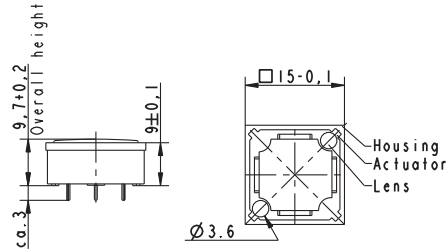

→ Contact materials	Illumination	Color of lens	LED color	LED type	Order no.
Au	not illuminated	transparent	-	-	3.14.100.001/0000
Ag	not illuminated	transparent	-	-	3.14.100.006/0000

For keycaps, refer to chapter accessories and system RK 90.

If exchangeable legends are required, or if an overall height of 12.5 mm is required, a keycap can be mounted on the non-illuminated keys. The keycap legend is visible through a window in the overlay. You can change the legend by replacing the keycap.



RF 15 Tactile switch, fully illuminated with 2 LED

Technical data see page 4 - 58

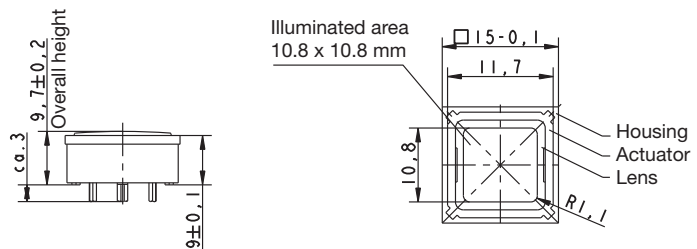

→ Contact materials	Illumination	Color of lens	LED color	LED type	Order no.
Au	fully illuminated 2 LED	red	red	2 mm	3.14.200.011/0000
Au	fully illuminated 2 LED	yellow	yellow	2 mm	3.14.200.013/0000
Au	fully illuminated 2 LED	orange	yellow	2 mm	3.14.200.014/0000
Au	fully illuminated 2 LED	green	green	2 mm	3.14.200.012/0000
Au	fully illuminated 2 LED	blue	blue	2 mm	3.14.200.015/0000
Ag	fully illuminated 2 LED	red	red	2 mm	3.14.200.021/0000
Ag	fully illuminated 2 LED	yellow	yellow	2 mm	3.14.200.023/0000
Ag	fully illuminated 2 LED	orange	yellow	2 mm	3.14.200.024/0000

4

RF

– Table (continued) –
RF 15 - Tactile switch, fully illuminated with 2 LED

→ Contact materials	Illumination	Color of lens	LED color	LED type	Order no.
Ag	fully illuminated 2 LED	green	green	2 mm	3.14.200.022/0000
Ag	fully illuminated 2 LED	blue	blue	2 mm	3.14.200.025/0000

For keycaps, refer to RK 90 system design.

Technical data of LED see separate page at the beginning of this chapter.

RF 15 Tactile switch, 1 LED spot-illumination

Technical data see page 4 - 58

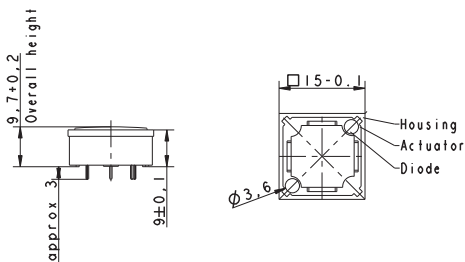

→ Contact materials	Illumination	Color of lens	LED color	LED type	Order no.
Au	spot illumination 1 LED	transparent	red	3 mm	3.14.100.031/0000
Au	spot illumination 1 LED	transparent	yellow	3 mm	3.14.100.033/0000
Au	spot illumination 1 LED	transparent	green	3 mm	3.14.100.032/0000
Au	spot illumination 1 LED	opaque white	blue	3 mm	3.14.100.030/0000
Ag	spot illumination 1 LED	transparent	red	3 mm	3.14.100.041/0000
Ag	spot illumination 1 LED	transparent	yellow	3 mm	3.14.100.043/0000
Ag	spot illumination 1 LED	transparent	green	3 mm	3.14.100.042/0000
Ag	spot illumination 1 LED	transparent	blue	3 mm	3.14.100.040/0000

Double-spot LED illumination available on request

Technical data of LED see separate page at the beginning of this chapter.

PCB KEY SWITCHES

RF 15 N - TACTILE SWITCHES



RF 15 N Tactile switches

→ The RF 15N key switch provides a minimum overall height of 6.2 mm. The overall height can be varied by extension plungers which are inserted into the cross-like notches on the actuator tops.

LEDs can only be arranged separately next to the key switches up to an overall height of 10 mm (i.e. without plunger or with small plunger).

Key switches with overall heights of 12 mm or more can be provided with a maximum of 2 LEDs which are inserted into the recesses of the key switch housing. LEDs of key switches with overall heights of 12.5 mm or more should be placed onto LED spacers in order to obtain satisfactory illumination.



Technical Data

→ General information

Color of lens	see order block
Recommended key grid	19.05 mm

→ Dimensions

Length	15 mm
Width	15 mm
Overall height	6.2 mm

→ Mechanical design

Mounting	soldering in PCB
Terminals	THT
Contact system	snap-action contact
Contact arrangement	1 NO
Contact materials	see order block
Illumination	external 3 mm LED possible if height more than 12 mm

→ Mechanical characteristics

Operating force max.	2.9 ^{+0.6} N
Switching travel	0.5 ^{+0.2} mm
Robustness max.	100 with through-plated PCB N

→ Electrical characteristics

Rated voltage min.	Au: 0.02 V, Ag: 3 V
Rated voltage max.	35 V
Rated current min.	Au: 0.01 mA, Ag: 0.1 mA
Rated current max.	Au: 100 mA, Ag: 250 mA
Rated power max. (ohmic load)	Au: 2 W, Ag: 12.5 W
Contact resistance when new max.	100 mΩ
Insulation resistance	10 ⁹ Ω

→ Other specifications

Ambient temp. operating min.	-25 °C
Ambient temp. operating max.	+70 °C
Storage temperature max. (in tube)	+50 °C
Environmental resistance	acc. to IEC 60068-2-14, -30, -33 and -78
Operating life min. (operations)	1,000,000
Solderability / solder heat resistance	according to DIN EN 60068-2-20
Wave soldering	260 °C max.
Manual soldering	350 °C / 5 sec. max.
ROHS compliant	yes
REACH compliant	yes





4

RF

PCB KEY SWITCHES

RF 15 N - TACTILE SWITCHES

Accessories RF 15 N - Tactile switch

→ Description	Photo	Order no.	Additional accessories see page
RF 15 N - LED spacer Ø 5 mm, spacing length 2.2 mm, light grey, for use with overall height of 12.5 mm		5.30.109.010/0756	4 - 99
RF 15 N - Extension plunger, Ø 10 mm, overall height 22.5 mm		5.46.011.028/0710	4 - 95
RF 15 N - Extension plunger, Ø 15 mm, overall height 22.5 mm		5.46.017.028/0710	4 - 96
RF 15 N - Extension plunger, Ø 15 mm, overall height 22.5 mm		5.46.017.029/0710	-

PCB KEY SWITCHES

RF 15 N - TACTILE SWITCHES

Typical force travel diagram

Actuating characteristics
Force travel diagram

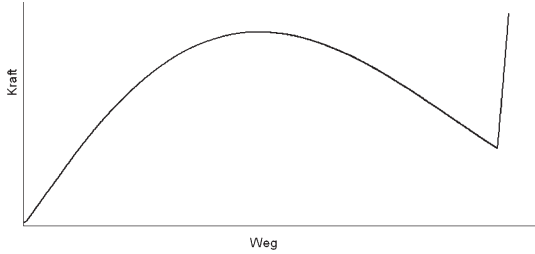

Circuit diagrams RF 15 N

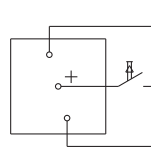

Tactile switch, non-illuminated

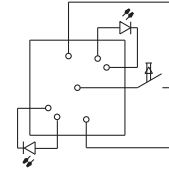

Tactile switch, spot-illuminated

Dimensional drawing RF 15 N

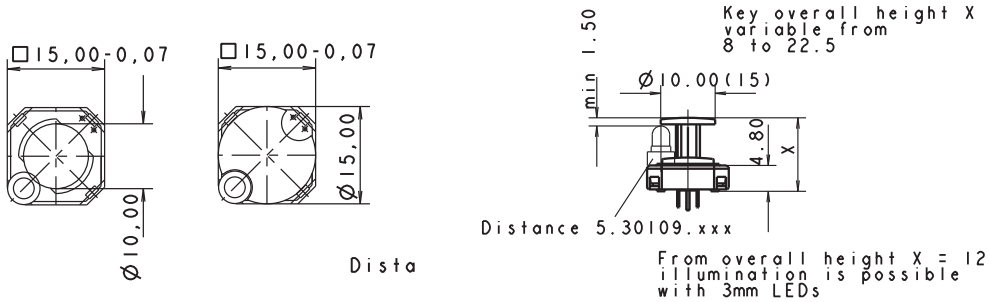

4

RF

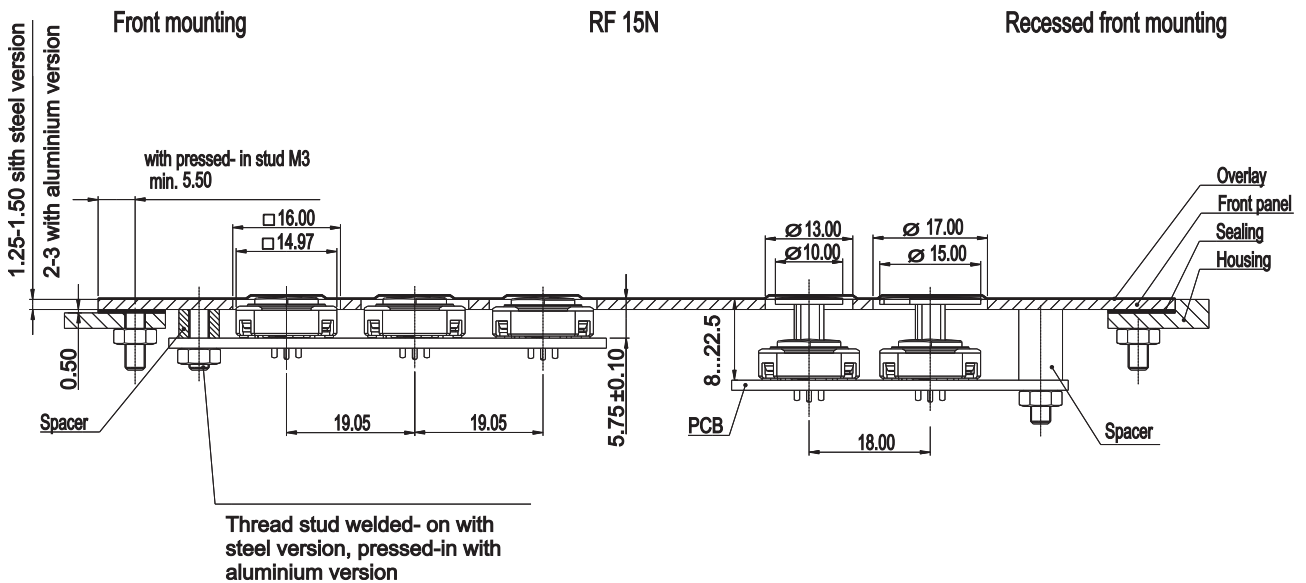

Hole patterns front panel RF 15 N

RF 15 N without plunger

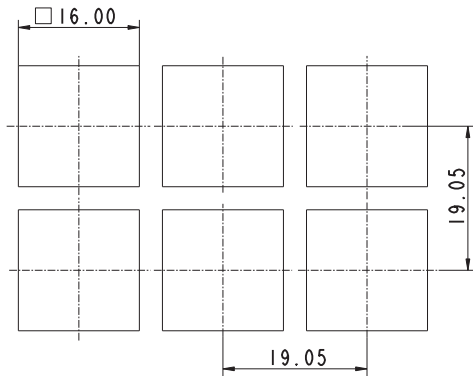

RF 15 N with plunger \varnothing 10 mm, not illuminated

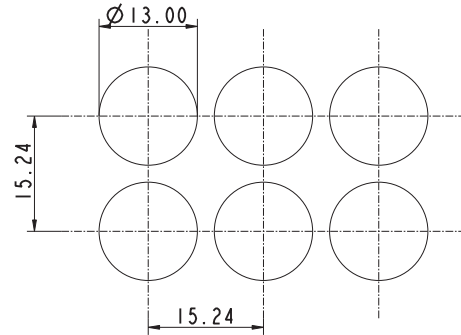

RF 15 N with plunger \varnothing 10 mm, illuminated

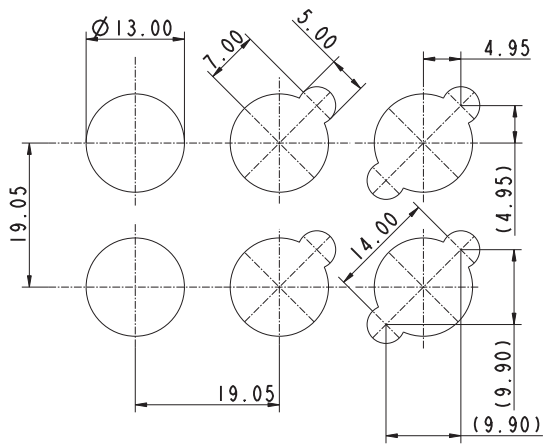

RF 15 N with plunger \varnothing 15 mm, illuminated

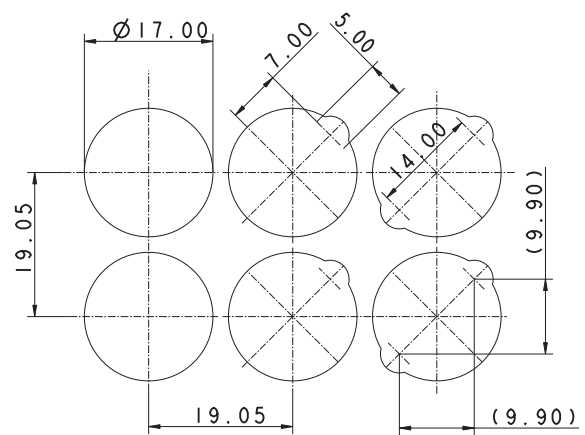

PCB hole patterns RF 15 N

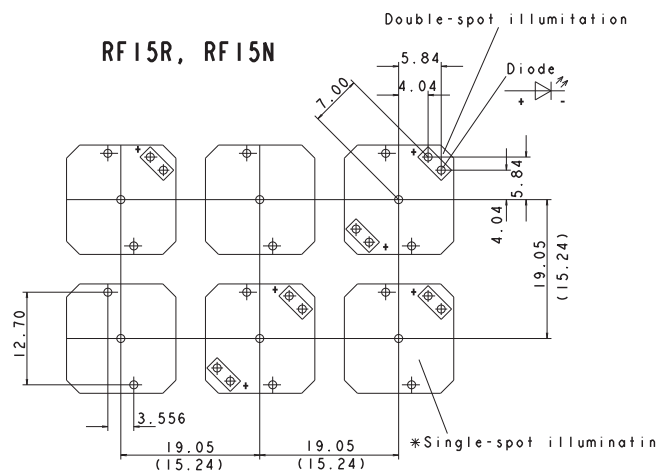

View on component side,
all hole diameters $1.1^{+0.1}$ mm
PCB layout switch 1/400" grid

PCB KEY SWITCHES

RF 15 N - TACTILE SWITCHES



RF 15 N Tactile switch, non-illuminated

Technical data see page 4 - 62

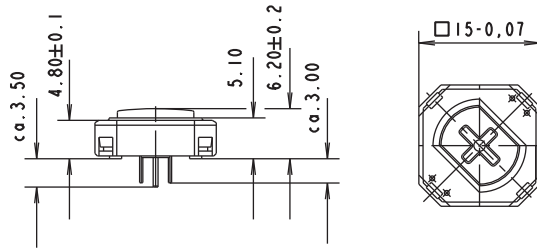

→ Contact materials	Illumination	Recommended key grid	Overall height	Order no.
Au	external 3 mm LED possible if height more than 12 mm	19.05 mm	6.2 mm	3.14.100.601/0000
Ag	external 3 mm LED possible if height more than 12 mm	19.05 mm	6.2 mm	3.14.100.606/0000

For keycaps, refer to RK 90 system design.
Double-spot LED illumination available on request.

RF 15 R Tactile switches

→ The round actuator of the RF 15 R key switch requires round front panel cut-outs. These make it possible to use a narrow keyboard grid of only 15.24 mm with sufficiently large frame webs between the individual keys. We recommend area embossing over the actuators for the overlay.



Technical Data

→ General information

Recommended key grid	15.24 mm
----------------------	----------

→ Dimensions

Length	15 mm
Width	15 mm
Overall height	see order block

→ Mechanical design

Mounting	soldering in PCB
Terminals	THT
Contact system	snap-action contact
Contact arrangement	1 NO
Contact materials	see order block
Illumination	see order block
LED color	see order block
LED type	see order block

→ Mechanical characteristics

Operating force max.	2.9 ^{±0.6} N
Switching travel	0.5 ^{+0.2} mm
Robustness max.	with through-plated PCB 100 N

→ Electrical characteristics

Rated voltage min.	Au: 0.02 V, Ag: 3 V
Rated voltage max.	35 V
Rated current min.	Au: 0.01 mA, Ag: 0.1 mA
Rated current max.	Au: 100 mA, Ag: 250 mA
Rated power max. (ohmic load)	Au: 2 W, Ag: 12.5 W
Contact resistance when new max.	100 mΩ
Insulation resistance	10 ⁹ Ω

→ Other specifications

Ambient temp. operating min.	-25 °C
Ambient temp. operating max.	+70 °C
Environmental resistance	acc. to IEC 60068-2-14, -30, -33 and -78
Operating life min. (operations)	1,000,000
Solderability / solder heat resistance	according to DIN EN 60068-2-20
Wave soldering	260 °C max.
Manual soldering	350 °C / 5 sec. max.
ROHS compliant	yes
REACH compliant	yes



PCB KEY SWITCHES

RF 15 R LOW - TACTILE SWITCHES

Typical force travel diagram

Actuating characteristics
Force travel diagram

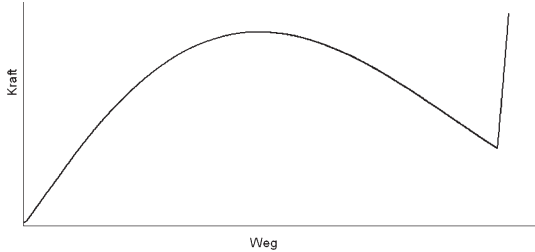

Circuit diagrams RF 15 R

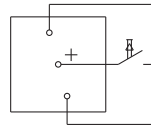

Tactile switch, non-illuminated

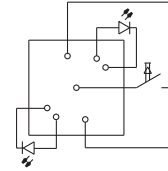

Tactile switch, spot-illuminated

Dimensional drawing RF 15 R

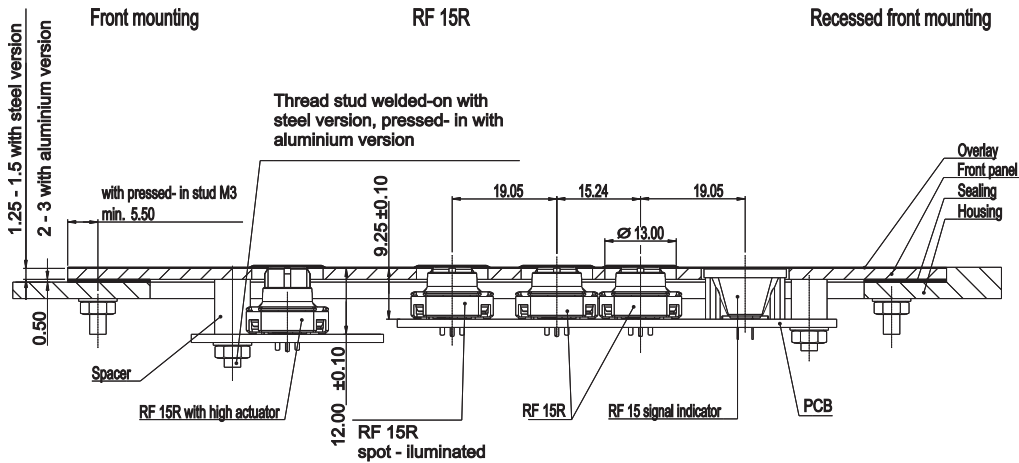

4

PCB hole patterns RF 15 R

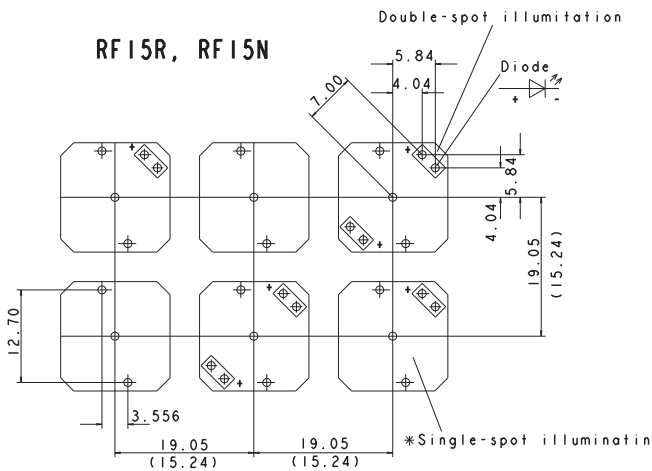

View on component side,
all hole diameters 1.1 ± 0.1 mm
PCB layout switch 1/400" grid

RF

PCB KEY SWITCHES

RF 15 R LOW - TACTILE SWITCHES

Hole patterns front panel RF 15 R

RF 15 R, not illuminated

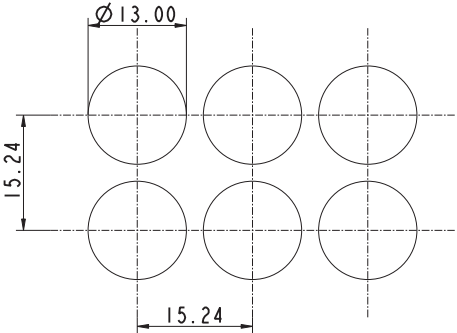

RF 15 R, illuminated

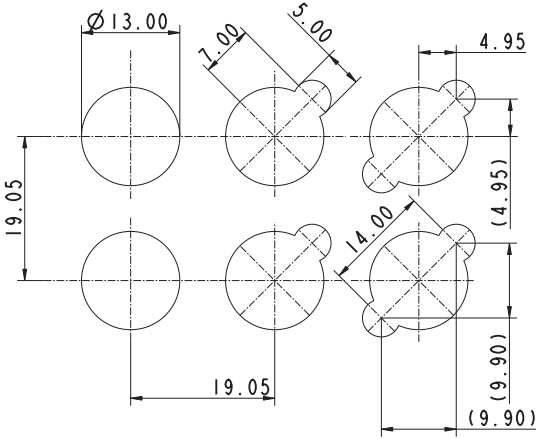

PCB KEY SWITCHES

RF 15 R LOW - TACTILE SWITCHES



RF 15 R Low tactile switch, non-illuminated

Technical data see page 4 - 67

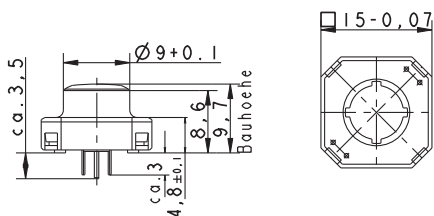

→ Contact materials	Overall height	Illumination	LED type	LED color	Order no.
Au	9.7 mm	not illuminated	-	-	3.14.100.501/0000
Ag	9.7 mm	not illuminated	-	-	3.14.100.506/0000



RF 15 R High tactile switch, non-illuminated

Technical data see page 4 - 67

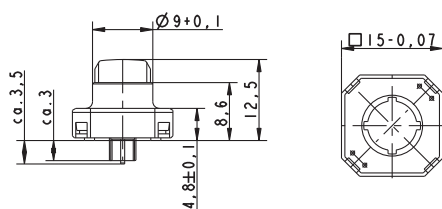

→ Contact materials	Overall height	Illumination	LED type	LED color	Order no.
Au	12.5 mm	not illuminated	-	-	3.14.100.801/0000
Ag	12.5 mm	not illuminated	-	-	3.14.100.806/0000

4

RF

RF 15 R Low tactile switch, 1 LED spot-illumination

Technical data see page 4 - 67

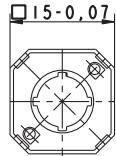
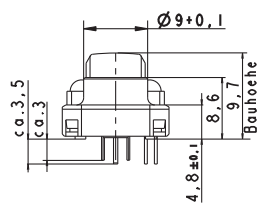

→ Contact materials	Overall height	Illumination	LED type	LED color	Order no.
Au	9.7 mm	spot illumination 1 LED	2 mm	red	3.14.100.531/0000
Au	9.7 mm	spot illumination 1 LED	2 mm	yellow	3.14.100.533/0000
Au	9.7 mm	spot illumination 1 LED	2 mm	green	3.14.100.532/0000
Ag	9.7 mm	spot illumination 1 LED	2 mm	red	3.14.100.541/0000
Ag	9.7 mm	spot illumination 1 LED	2 mm	yellow	3.14.100.543/0000
Ag	9.7 mm	spot illumination 1 LED	2 mm	green	3.14.100.542/0000

Versions with 2 LEDs available on request.

Technical data of LED see separate page at the beginning of this chapter.

RF 15 R High tactile switch, 1 LED spot-illumination

Technical data see page 4 - 67

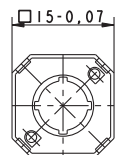
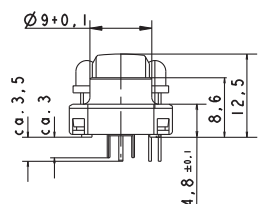

→ Contact materials	Overall height	Illumination	LED type	LED color	Order no.
Au	12.5 mm	spot illumination 1 LED	3 mm	red	3.14.100.831/0000
Au	12.5 mm	spot illumination 1 LED	3 mm	yellow	3.14.100.833/0000
Au	12.5 mm	spot illumination 1 LED	3 mm	green	3.14.100.832/0000

PCB KEY SWITCHES

RF 15 R LOW - TACTILE SWITCHES

– Table (continued) –

RF 15 R - High tactile switch, 1 LED spot-illumination

→ Contact materials	Overall height	Illumination	LED type	LED color	Order no.
Au	12.5 mm	spot illumination 1 LED	3 mm	blue	3.14.100.830/0000

Versions with 2 LEDs available on request.

Technical data of LED see separate page at the beginning of the chapter.

RF 15 H Tactile switches

→ Application notes:

The RF 15 H key has an overall height of 12.5 mm and can be fully illuminated. When designing membrane keyboards, we recommend using a key grid of at least 20 mm and a 0.13 mm overlay with area embossing over the keys.

You can use the O-ring (accessory) to block the key and use it as an indicator field or blank spaceholder.



Technical Data

→ General information

Color of lens	see order block
Recommended key grid	20 mm

→ Dimensions

Length	15 mm
Width	15 mm
Overall height	12.5 mm

→ Mechanical design

Mounting	soldering in PCB
Terminals	THT
Contact system	snap-action contact
Contact arrangement	1 NO
Contact materials	see order block
Illumination	see order block
LED color	see order block
LED type	see order block

→ Mechanical characteristics

Operating force max.	2.9 ^{+0.6} N
Switching travel	0.5 ^{+0.2} mm
Robustness max.	with through-plated PCB 100 N

→ Electrical characteristics

Rated voltage min.	Au: 0.02 V, Ag: 3 V
Rated voltage max.	35 V
Rated current min.	Au: 0.01 mA, Ag: 0.1 mA
Rated current max.	Au: 100 mA, Ag: 250 mA
Rated power max. (ohmic load)	Au: 2 W, Ag: 12.5 W
Contact resistance when new max.	100 mΩ
Insulation resistance	10 ⁹ Ω

→ Other specifications

Ambient temp. operating min.	-25 °C
Ambient temp. operating max.	+70 °C
Environmental resistance	acc. to IEC 60068-2-14, -30, -33 and -78
Operating life min. (operations)	1,000,000
Solderability / solder heat resistance	according to DIN EN 60068-2-20
Wave soldering	260 °C max.
Manual soldering	350 °C / 5 sec. max.
ROHS compliant	yes
REACH compliant	yes



PCB KEY SWITCHES

RF 15 H - TACTILE SWITCHES

Accessories RF 15 H - Tactile switch

→ Description	Photo	Order no.	Additional accessories see page
O-ring, black, 16.0 x 1, for blocking RF 19H keys		5.30.125.007/0100	5 - 31

4

RF

PCB KEY SWITCHES

RF 15 H - TACTILE SWITCHES

Typical force travel diagram RF 15 H

Actuating characteristics
Force travel diagram

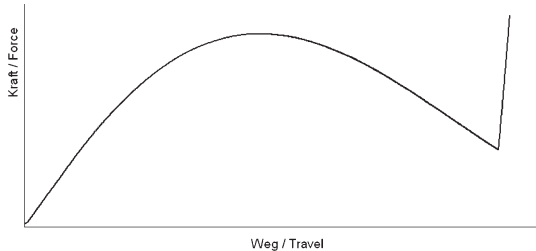

Curcuit diagram RF 15 H

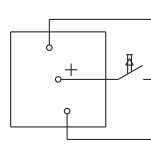

Tactile switch, non-illuminated

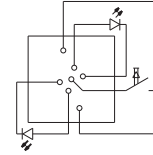

Tactile switch, fully-illuminated

Dimensional drawing RF 15 H

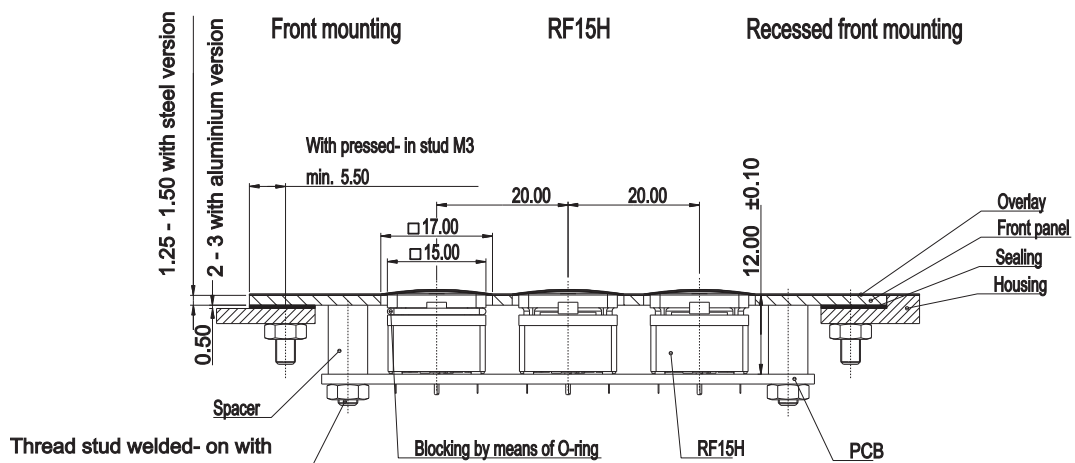

Hole Pattern

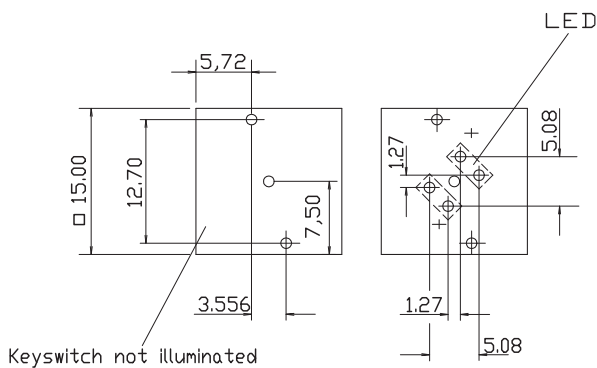

View on component side.

Hole Pattern – Front Panel

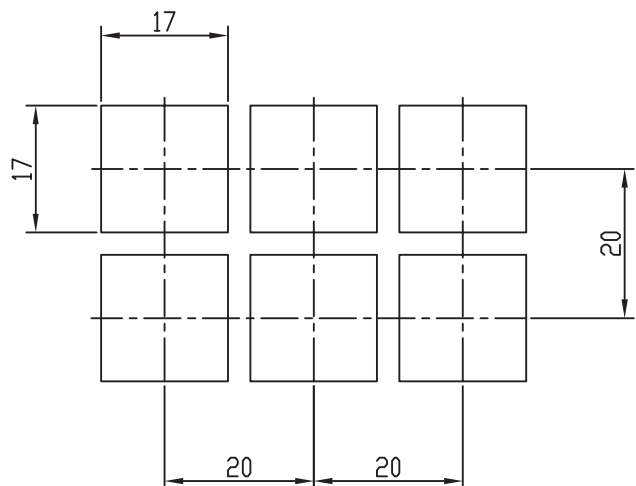

PCB KEY SWITCHES

RF 15 H - TACTILE SWITCHES



RF 15 H Tactile switch, non-illuminated

Technical data see page 4 - 73

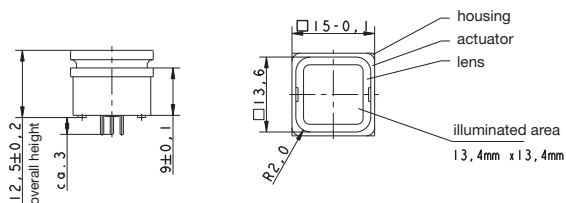

→ Contact materials	Illumination	Color of lens	LED color	LED type	Order no.
Au	not illuminated	white	-	-	3.14.100.702/0000
Ag	not illuminated	white	-	-	3.14.100.707/0000



RF 15 H Tactile switch, fully illuminated

Technical data see page 4 - 73

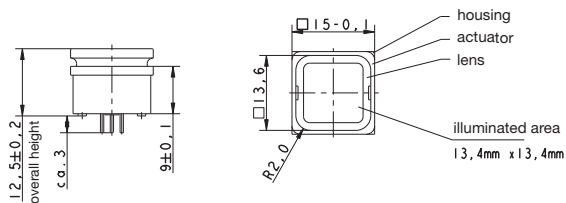

→ Contact materials	Illumination	Color of lens	LED color	LED type	Order no.
Au	fully illuminated 2 LED	red	red	2 mm	3.14.200.731/0000
Au	fully illuminated 2 LED	yellow	yellow	2 mm	3.14.200.733/0000
Au	fully illuminated 2 LED	orange	yellow	2 mm	3.14.200.738/0000
Au	fully illuminated 1 LED	green	green super bright	3 mm	3.14.200.736/0000
Au	fully illuminated 2 LED	green	green	2 mm	3.14.200.732/0000
Au	fully illuminated 1 LED	blue	blue	3 mm	3.14.200.739/0000
Au	fully illuminated 1 LED	white	white	3 mm	3.14.200.735/0000
Ag	fully illuminated 2 LED	red	red	2 mm	3.14.200.741/0000
Ag	fully illuminated 2 LED	yellow	yellow	2 mm	3.14.200.743/0000
Ag	fully illuminated 2 LED	orange	yellow	2 mm	3.14.200.748/0000
Ag	fully illuminated 1 LED	green	green super bright	3 mm	3.14.200.746/0000

– Table (continued) –
RF 15 H - Tactile switch, fully illuminated

→ Contact materials	Illumination	Color of lens	LED color	LED type	Order no.
Ag	fully illuminated 2 LED	green	green	2 mm	3.14.200.742/0000
Ag	fully illuminated 1 LED	blue	blue	3 mm	3.14.200.749/0000
Ag	fully illuminated 1 LED	white	white	3 mm	3.14.200.745/0000

When using the key switches with multicolor LEDs the illumination color can be varied from red to green by change of polarity. Due to the frequency of the polarity-changes the colors red, green, yellow as well as all secondary colors from these are possible.

Technical data of LED see separate page at the beginning of this chapter.



RF 15 Signal indicators

Technical Data

→ **General information**

Color of lens	see order block
Recommended key grid	19.05 mm

→ **Dimensions**

Length	15 mm
Width	15 mm
Overall height	9.15 mm

→ **Mechanical design**

Mounting	THT soldering in PCB
Illumination	fully illuminated 1 LED
LED color	see order block
LED type	2 mm

→ **Other specifications**

Ambient temp. operating min.	-25 °C
Ambient temp. operating max.	+70 °C
Environmental resistance	acc. to IEC 60068-2-14, -30, -33 and -78
Solderability / solder heat resistance	according to DIN EN 60068-2-20
Wave soldering	260 °C max.
Manual soldering	350 °C / 5 sec. max.
ROHS compliant	yes
REACH compliant	yes

PCB KEY SWITCHES

RF 15 - SIGNAL INDICATORS



RF 15 Signal indicator, fully illuminated, 1 LED

Technical data see page 4 - 78

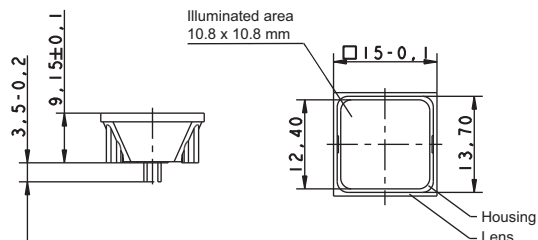

→ Overall height	Illumination	Color of lens	LED color	LED type	Order no.
9.15 mm	fully illuminated 1 LED	red	red	2 mm	3.14.200.051/0000
9.15 mm	fully illuminated 1 LED	yellow	yellow	2 mm	3.14.200.053/0000
9.15 mm	fully illuminated 1 LED	orange	yellow	2 mm	3.14.200.054/0000
9.15 mm	fully illuminated 1 LED	green	green	2 mm	3.14.200.052/0000
9.15 mm	fully illuminated 1 LED	blue	blue	2 mm	3.14.200.055/0000

Technical data of LED see separate page at the beginning of chapter 4 PCB Key switches.

RF 19 Tactile switches

→ Application notes:

RF 19 keys offer a large actuation area. When designing low-profile keyboards with a grid of ≥ 23 mm, frame webs remain free between the individual keys.

The overlay can be glued onto these frame webs; we recommend area embossing over the keys for the overlay.



Technical Data

→ General information

Color of lens	see order block
Recommended key grid	23 mm

→ Dimensions

Length	19.05 mm
Width	19.05 mm
Overall height	9.7 mm

→ Mechanical design

Mounting	soldering in PCB
Terminals	THT
Contact system	snap-action contact
Contact arrangement	1 NO
Contact materials	see order block
Illumination	see order block
LED color	see order block
LED type	see order block

→ Mechanical characteristics

Operating force max.	2.9 ^{+0.6} N
Switching travel	0.5 ^{+0.2} mm
Robustness max.	with through-plated PCB 100 N

→ Electrical characteristics

Rated voltage min.	Au: 0.02 V, Ag: 3 V
Rated voltage max.	35 V
Rated current min.	Au: 0.01 mA, Ag: 0.1 mA
Rated current max.	Au: 100 mA, Ag: 250 mA
Rated power max. (ohmic load)	Au: 2 W, Ag: 12.5 W
Contact resistance when new max.	100 mΩ
Insulation resistance	10 ⁹ Ω

→ Other specifications

Ambient temp. operating min.	-25 °C
Ambient temp. operating max.	+70 °C
Environmental resistance	acc. to IEC 60068-2-14, -30, -33 and -78
Operating life min. (operations)	1,000,000
Solderability / solder heat resistance	according to DIN EN 60068-2-20
Wave soldering	260 °C max.
Manual soldering	350 °C / 5 sec. max.
ROHS compliant	yes
REACH compliant	yes



PCB KEY SWITCHES

RF 19 - TACTILE SWITCHES

Typical force travel diagram RF 19

Actuating characteristics
Force travel diagram

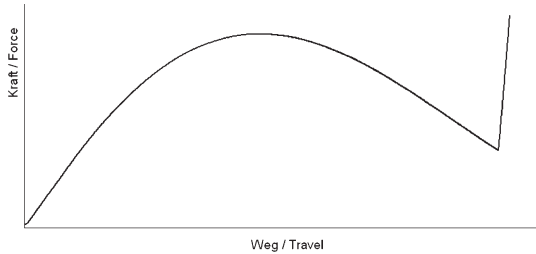

Circuit diagrams RF 19

Hole patterns (view on component side)

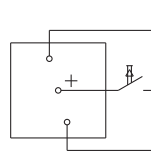

Tactile switch, non-illuminated

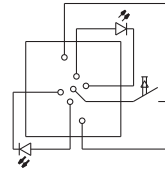

Tactile switch, fully-illuminated

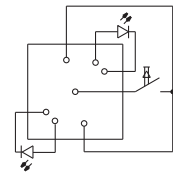

Tactile switch, spot-illuminated

System assembly RF 19

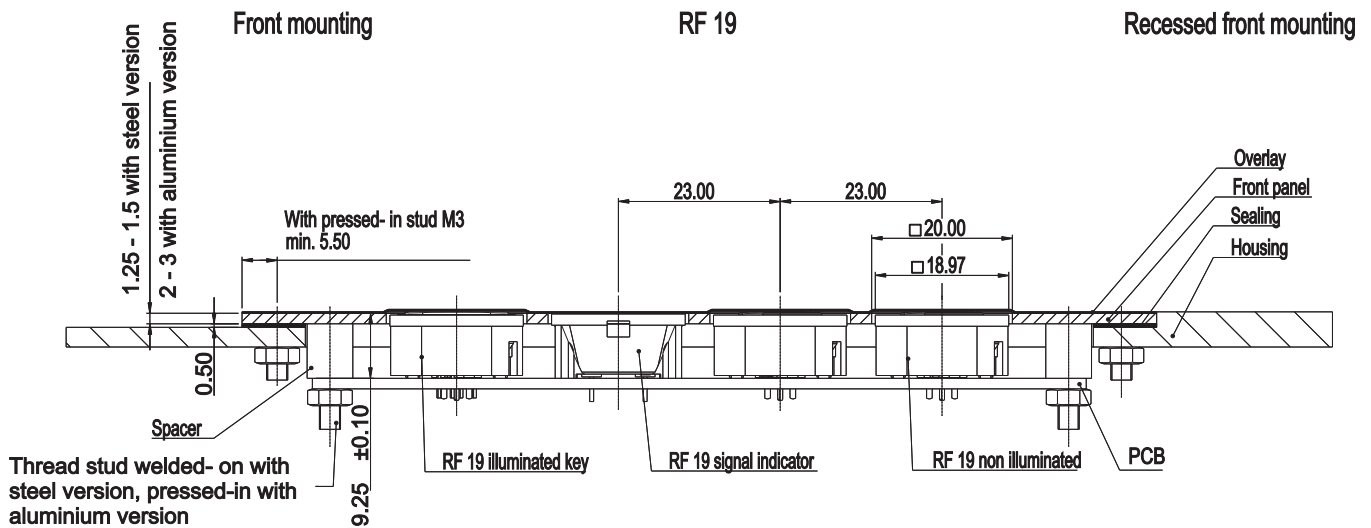

4

RF

PCB hole patterns RF 19

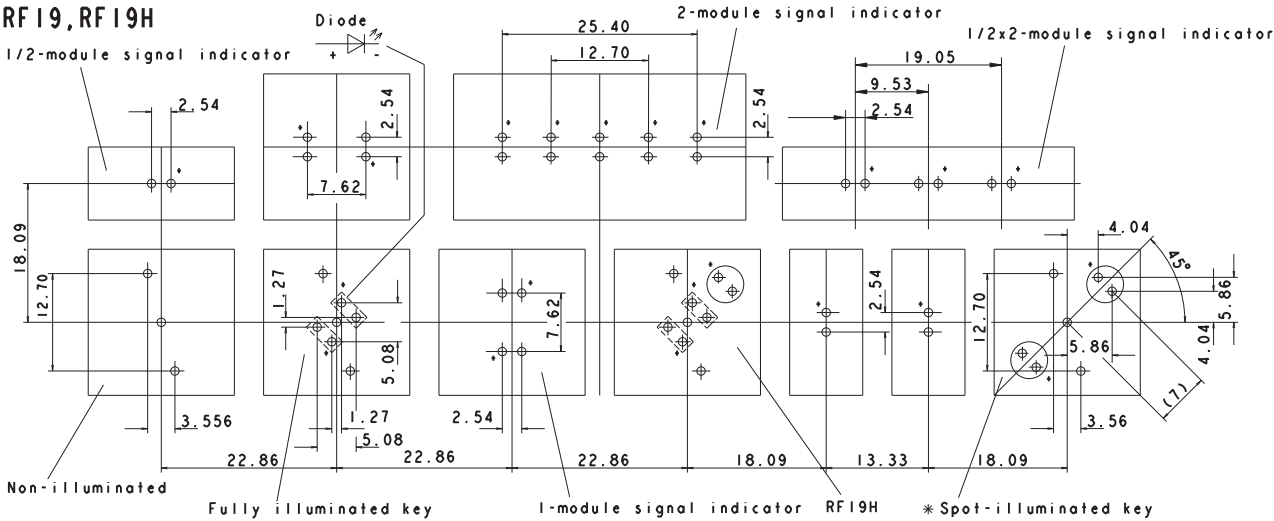

* The LED may be positioned either on the left-hand or right-hand side.
Standard version: LED on left-hand side
View on component side, all hole diameters $1.1^{+0.1}$ mm

Hole patterns front panel RF 19

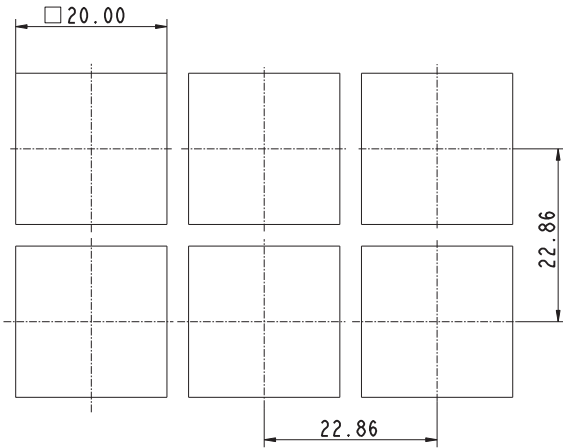

PCB KEY SWITCHES

RF 19 - TACTILE SWITCHES



RF 19 Tactile switch, non-illuminated

Technical data see page 4 - 81

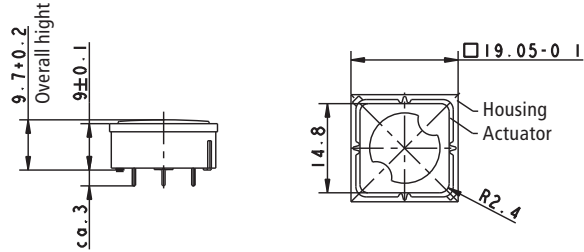

→ Contact materials	Illumination	Color of lens	LED color	LED type	Order no.
Au	not illuminated	transparent	-	-	3.14.001.001/0000
Ag	not illuminated	transparent	-	-	3.14.001.006/0000



RF 19 Tactile switch, fully illuminated with 2 LED

Technical data see page 4 - 81

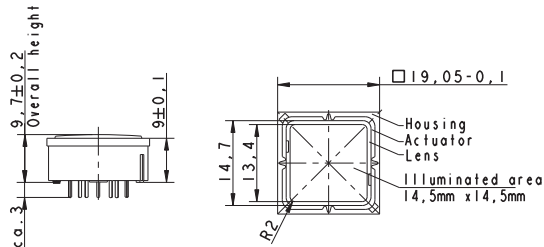

→ Contact materials	Illumination	Color of lens	LED color	LED type	Order no.
Au	fully illuminated 2 LED	red	red	2 mm	3.14.002.011/0000
Au	fully illuminated 2 LED	yellow	yellow	2 mm	3.14.002.013/0000
Au	fully illuminated 2 LED	orange	yellow	2 mm	3.14.002.014/0000
Au	fully illuminated 2 LED	green	green	2 mm	3.14.002.012/0000
Au	fully illuminated 2 LED	blue	blue	2 mm	3.14.002.015/0000
Au	fully illuminated 2 LED	opaque white	green	2 mm	3.14.002.901/0000
Ag	fully illuminated 2 LED	red	red	2 mm	3.14.002.021/0000
Ag	fully illuminated 2 LED	yellow	yellow	2 mm	3.14.002.023/0000
Ag	fully illuminated 2 LED	orange	yellow	2 mm	3.14.002.024/0000
Ag	fully illuminated 2 LED	green	green	2 mm	3.14.002.022/0000

4

RF

– Table (continued) –
RF 19 - Tactile switch, fully illuminated with 2 LED

→ Contact materials	Illumination	Color of lens	LED color	LED type	Order no.
Ag	fully illuminated 2 LED	blue	blue	2 mm	3.14.002.025/0000
Ag	fully illuminated 2 LED	white	yellow	2 mm	3.14.002.027/0000
Ag	fully illuminated 2 LED	white	green	2 mm	3.14.002.026/0000
Ag	fully illuminated 2 LED	opaque white	green	2 mm	3.14.002.944/0000

Technical data of LED see separate page at the beginning of this chapter.

RF 19 Tactile switch, 1 LED spot-illumination

Technical data see page 4 - 81

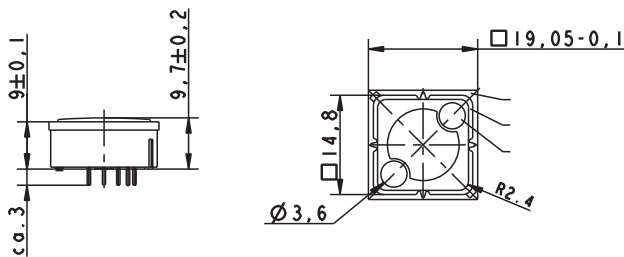

→ Contact materials	Illumination	Color of lens	LED color	LED type	Order no.
Au	spot illumination 1 LED	transparent	red	3 mm	3.14.001.031/0000
Au	spot illumination 1 LED	transparent	yellow	3 mm	3.14.001.033/0000
Au	spot illumination 1 LED	transparent	green	3 mm	3.14.001.032/0000
Au	spot illumination 1 LED	opaque white	blue	3 mm	3.14.001.030/0000
Ag	spot illumination 1 LED	transparent	red	3 mm	3.14.001.041/0000
Ag	spot illumination 1 LED	transparent	yellow	3 mm	3.14.001.043/0000
Ag	spot illumination 1 LED	transparent	green	3 mm	3.14.001.042/0000
Ag	spot illumination 1 LED	transparent	blue	3 mm	3.14.001.040/0000

Versions with 2 LEDs available on request.

Technical data of LED see separate page at the beginning of this chapter.

PCB KEY SWITCHES

RF 19 H - TACTILE SWITCHES

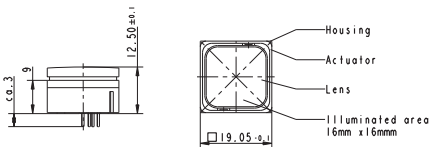

RF 19 H Tactile switches

→ Application notes:

The RF 19H key has an overall height of 12.5 mm and can be fully illuminated. When designing membrane keyboards, we recommend using a key grid of at least 24 mm and a 0.13 mm overlay with area embossing over the keys.

You can use the O-ring (accessory) to block the key and use it as an indicator field or blank spaceholder.

Technical Data

→ General information

Color of lens	see order block
Recommended key grid	24 mm

→ Dimensions

Length	19.05 mm
Width	19.05 mm
Overall height	12.5 mm

→ Mechanical design

Mounting	soldering in PCB
Terminals	THT
Contact system	snap-action contact
Contact arrangement	1 NO
Contact materials	see order block
Illumination	see order block
LED color	see order block
LED type	see order block

→ Mechanical characteristics

Operating force max.	2.9 ^{+0.6} N
Switching travel	0.5 ^{+0.2} mm
Robustness max.	with through-plated PCB 100 N

→ Electrical characteristics

Rated voltage min.	Au: 0.02 V, Ag: 3 V
Rated voltage max.	35 V
Rated current min.	Au: 0.01 mA, Ag: 0.1 mA
Rated current max.	Au: 100 mA, Ag: 250 mA
Rated power max. (ohmic load)	Au: 2 W, Ag: 12.5 W
Contact resistance when new max.	100 mΩ
Insulation resistance	10 ⁹ Ω

→ Other specifications

Ambient temp. operating min.	-25 °C
Ambient temp. operating max.	+70 °C
Environmental resistance	acc. to IEC 60068-2-14, -30, -33 and -78
Operating life min. (operations)	1,000,000
Solderability / solder heat resistance	according to DIN EN 60068-2-20
Wave soldering	260 °C max.
Manual soldering	350 °C / 5 sec. max.
ROHS compliant	yes
REACH compliant	yes

4

RF

PCB KEY SWITCHES

RF 19 H - TACTILE SWITCHES

Accessories RF 19 H - Tactile switch

→ Description	Photo	Order no.	Additional accessories see page
O-ring, black, 16.0 x 1, for blocking RF 19H keys		5.30.125.007/0100	5 - 31

PCB KEY SWITCHES

RF 19 H - TACTILE SWITCHES

Typical force travel diagram RF 19 H

Actuating characteristics
Force travel diagram

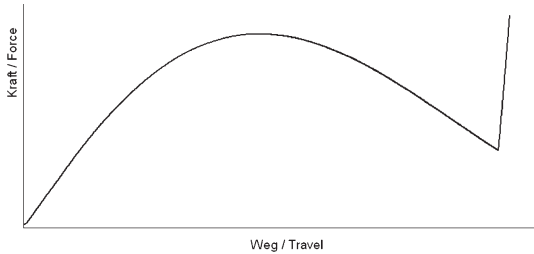

Circuit diagrams RF 19 H

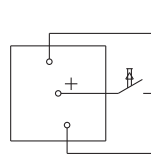

Tactile switch, non-illuminated

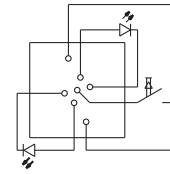

Tactile switch, fully-illuminated

System assembly RF 19 H

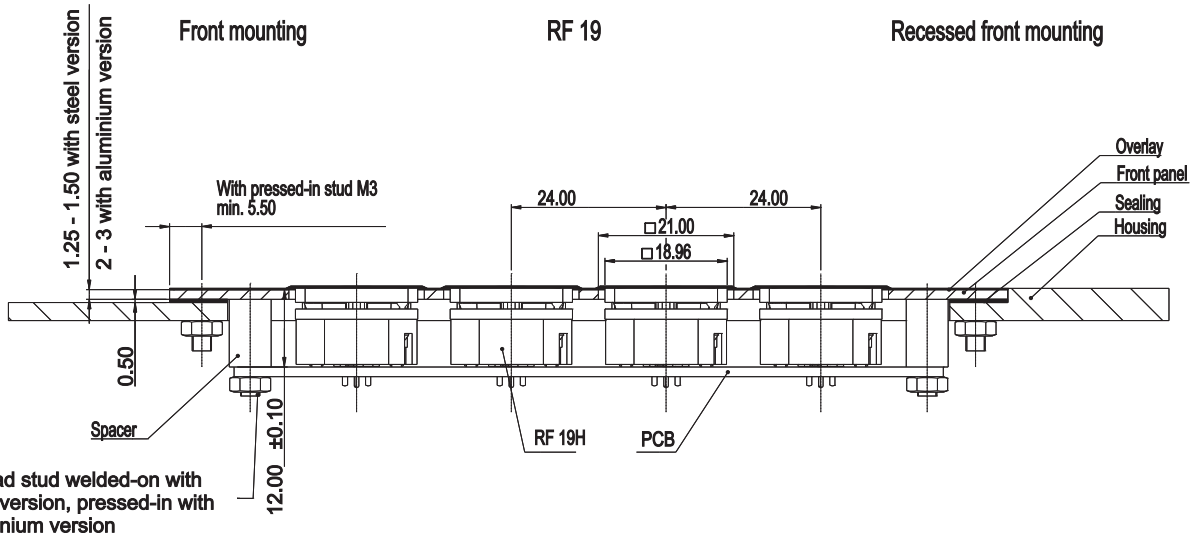

PCB hole patterns RF 19 H

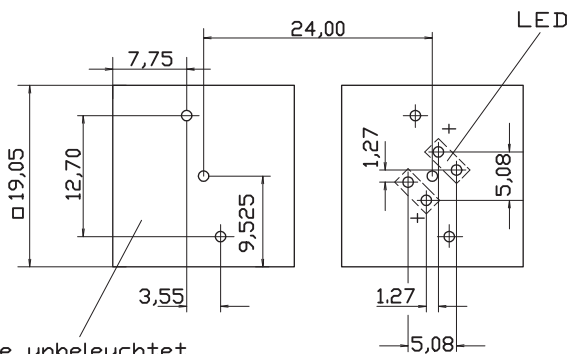

Taste unbeleuchtet
keyswitch not illuminated

View on component side, all hole diameters $1.1^{±0.1}$ mm

Hole patterns front panel RF 19 H

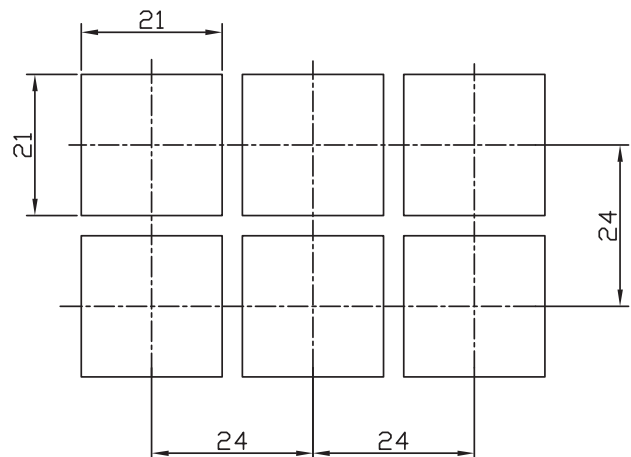

RF 19 H Tactile switch, non-illuminated

Technical data see page 4 - 86

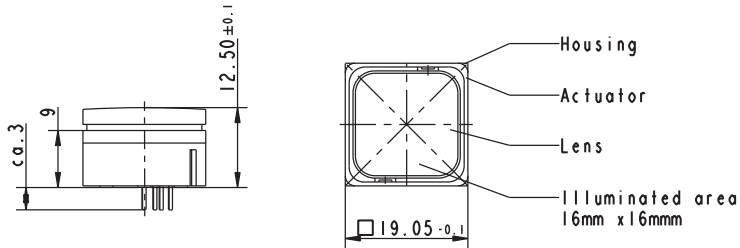

→ Contact materials	Illumination	Color of lens	LED color	LED type	Order no.
Au	not illuminated	white	-	-	3.14.001.501/0000
Ag	not illuminated	white	-	-	3.14.001.506/0000

RF 19 H Tactile switch, fully illuminated

Technical data see page 4 - 86

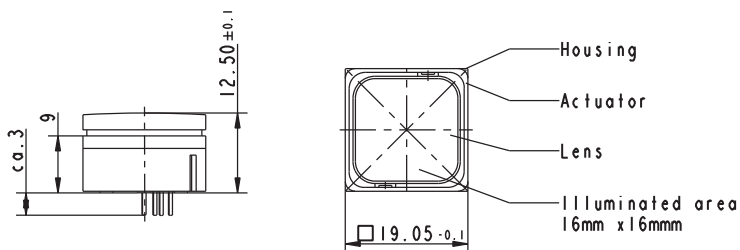

→ Contact materials	Illumination	Color of lens	LED color	LED type	Order no.
Au	fully illuminated 2 LED	red	red	2 mm	3.14.002.613/0000
Au	fully illuminated 2 LED	yellow	yellow	2 mm	3.14.002.653/0000
Au	fully illuminated 2 LED	orange	yellow	2 mm	3.14.002.673/0000
Au	fully illuminated 1 LED	green	green super bright	3 mm	3.14.002.633/0000
Au	fully illuminated 2 LED	green	green	2 mm	3.14.002.632/0000
Au	fully illuminated 1 LED	blue	blue	3 mm	3.14.002.683/0000
Au	fully illuminated 1 LED	white	white	3 mm	3.14.002.684/0000
Ag	fully illuminated 2 LED	red	red	2 mm	3.14.002.623/0000
Ag	fully illuminated 2 LED	yellow	yellow	2 mm	3.14.002.663/0000
Ag	fully illuminated 2 LED	orange	yellow	2 mm	3.14.002.678/0000
Ag	fully illuminated 1 LED	green	green super bright	3 mm	3.14.002.643/0000

PCB KEY SWITCHES

RF 19 H - TACTILE SWITCHES

– Table (continued) –
RF 19 H - Tactile switch, fully illuminated

→ Contact materials	Illumination	Color of lens	LED color	LED type	Order no.
Ag	fully illuminated 2 LED	green	green	2 mm	3.14.002.642/0000
Ag	fully illuminated 1 LED	blue	blue	3 mm	3.14.002.688/0000
Ag	fully illuminated 1 LED	white	white	3 mm	3.14.002.689/0000

When using the key switches with multicolor LEDs the illumination color can be varied from red to green by change of polarity. Due to the frequency of the polarity-changes the colors red, green, yellow as well as all secondary colors from these are possible.

Technical data of LED see separate page at the beginning of this chapter.

RF 19

Signal indicators

Technical Data

→ **General information**

Color of lens	see order block
Recommended key grid	23/x mm

→ **Dimensions**

Length	see order block
Width	see order block
Overall height	9.15 mm

→ **Mechanical design**

Mounting	THT soldering in PCB
Illumination	see order block
LED color	see order block
LED type	see order block

→ **Other specifications**

Ambient temp. operating min.	-25 °C
Ambient temp. operating max.	+70 °C
Environmental resistance	acc. to IEC 60068-2-14, -30, -33 and -78
Solderability / solder heat resistance	according to DIN EN 60068-2-20
Wave soldering	260 °C max.
Manual soldering	350 °C / 5 sec. max.
ROHS compliant	yes
REACH compliant	yes



PCB KEY SWITCHES

RF 19 - SIGNAL INDICATORS

System assembly RF 19 signal indicator

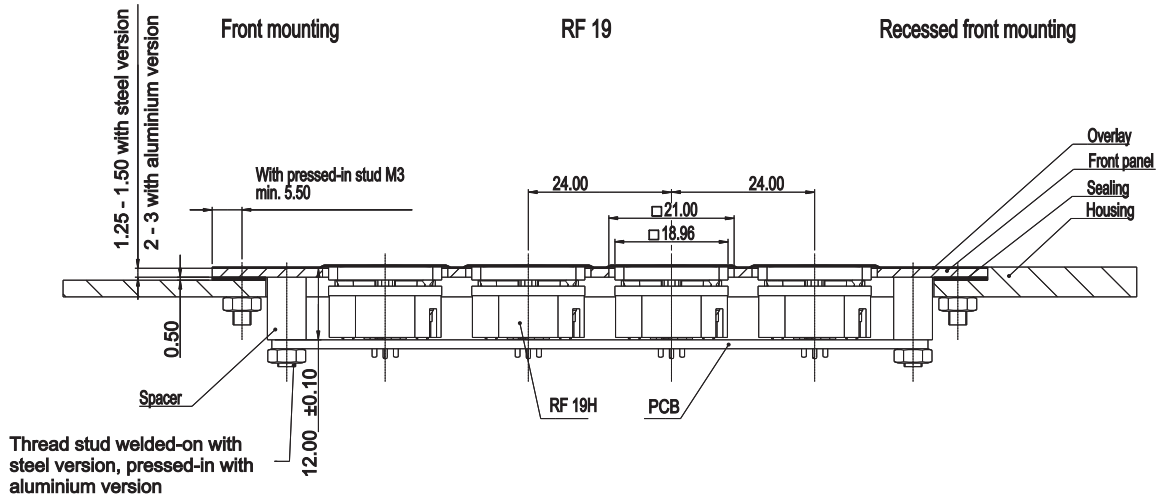

PCB hole pattern RF 19

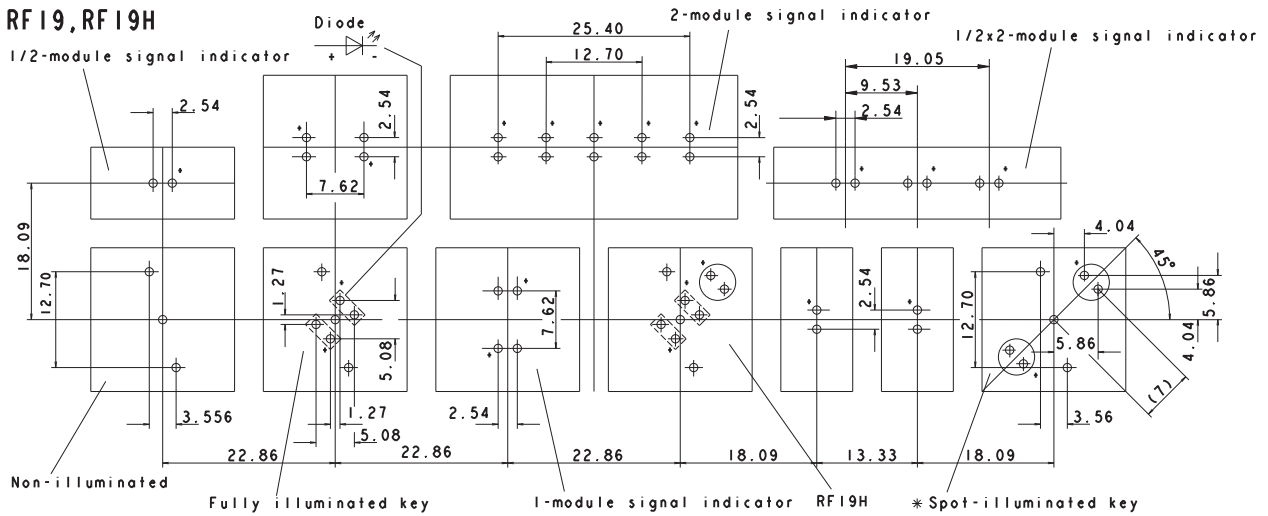

* The LED may be positioned either on the left-hand or right-hand side.
 Standard version: LED on left-hand side
 View on component side, all hole diameters 1.1 ± 0.1 mm

Hole patterns front panel = size of indicator + 1 mm

4

RF

RF 19 Signal indicator, 1/2 x 1-module

Technical data see page 4 - 91

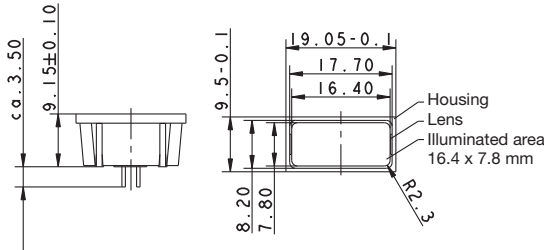

→ Illumination	Color of lens	LED color	LED type	Order no.
fully illuminated 1 LED	red	red	2 mm	3.14.002.061/0000
fully illuminated 1 LED	yellow	yellow	2 mm	3.14.002.063/0000
fully illuminated 1 LED	orange	yellow	2 mm	3.14.002.064/0000
fully illuminated 1 LED	green	green	2 mm	3.14.002.062/0000

Technical data of LED see separate page at the beginning of chapter 4 PCB Key switches.

RF 19 Signal indicator, 1/2 x 2-module

Technical data see page 4 - 91

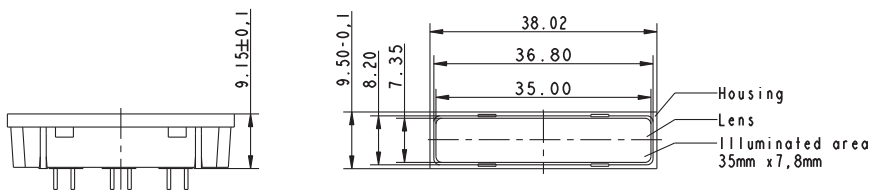
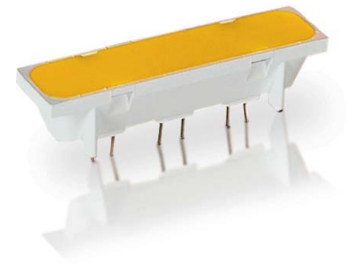

→ Illumination	Color of lens	LED color	LED type	Order no.
fully illuminated 3 LED	red	red	2 mm	3.14.002.908/0000
fully illuminated 3 LED	yellow	yellow	2 mm	3.14.002.910/0000
fully illuminated 3 LED	orange	yellow	2 mm	3.14.002.911/0000
fully illuminated 3 LED	green	green	2 mm	3.14.002.909/0000

Technical data of LED see separate page at the beginning of chapter 4 PCB Key switches.

PCB KEY SWITCHES

RF 19 - SIGNAL INDICATORS



RF 19 Signal indicator, 1 x 1-module

Technical data see page 4 - 91

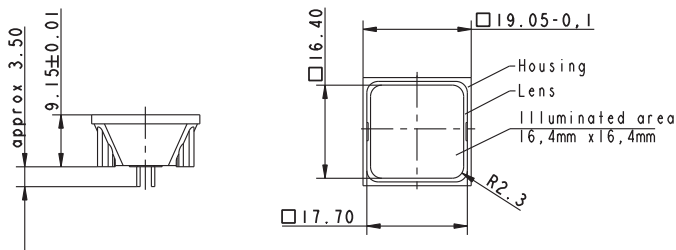

→ Illumination	Color of lens	LED color	LED type	Order no.
fully illuminated 2 LED	red	red	2 mm	3.14.002.051/0000
fully illuminated 2 LED	yellow	yellow	2 mm	3.14.002.053/0000
fully illuminated 2 LED	orange	yellow	2 mm	3.14.002.054/0000
fully illuminated 2 LED	green	green	2 mm	3.14.002.052/0000
fully illuminated 2 LED	blue	blue	2 mm	3.14.001.659/0000

For technical data of the LED see separate page at the beginning of chapter „RF tactile switches“

Suitable for RK 90 system design, illuminated for 2-module keycap.



RF 19 Signal indicator, 1 x 2-module

Technical data see page 4 - 91

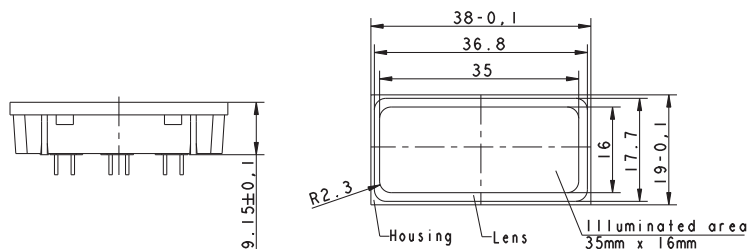

→ Illumination	Color of lens	LED color	LED type	Order no.
fully illuminated 5 LED	red	red	2 mm	3.14.002.071/0000
fully illuminated 5 LED	yellow	yellow	2 mm	3.14.002.073/0000
fully illuminated 5 LED	orange	yellow	2 mm	3.14.002.074/0000
fully illuminated 5 LED	green	green	2 mm	3.14.002.072/0000

For technical data of the LED see separate page at the beginning of chapter „RF tactile switches“

RF 15/19 Special accessories



RF 15 N Extension plunger, round head

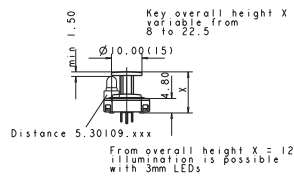
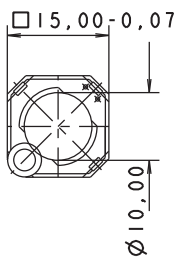

→ Length	Width	Overall height	Diameter	Color	Order no.
-	-	9 mm	10 mm	-	5.46.011.036/0710
-	-	9.7 mm	10 mm	-	5.46.011.030/0710
-	-	12.5 mm	10 mm	-	5.46.011.037/0710
-	-	13 mm	10 mm	-	5.46.011.038/0710
-	-	22.5 mm	10 mm	-	5.46.011.028/0710

Length of plunger = Overall height - 4.25 mm.

PCB KEY SWITCHES

RF 15/19 - SPECIAL ACCESSORIES



RF 15 N Extension plunger, round head, with recess for LED

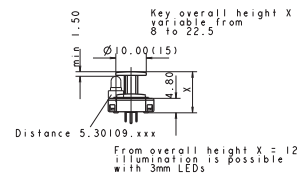
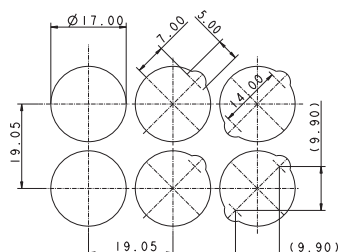

→ Length	Width	Overall height	Diameter	Color	Order no.
-	-	9 mm	15 mm	-	5.46.017.036/0710
-	-	9.7 mm	15 mm	-	5.46.017.030/0710
-	-	12.5 mm	15 mm	-	5.46.017.037/0710
-	-	22.5 mm	15 mm	-	5.46.017.028/0710
-	-	13 mm	15 mm	-	5.46.017.038/0710

Length of plunger = Overall height - 4.25 mm.



RF 15 Keycap, snap-on, for overall height 12.5 mm

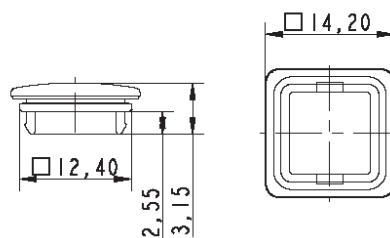

→ Length	Width	Overall height	Diameter	Color	Order no.
14.2 mm	14.2 mm	12.5 mm	-	beige	5.46.654.059/0227

4

RF

Spacer, round

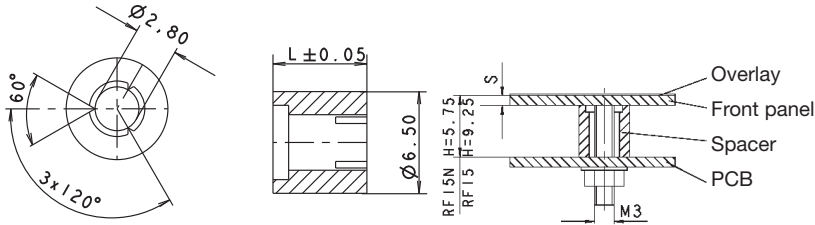

→ Length L	Color	Order no.
3.50 mm	blue transparent	5.30.759.023/0000
4.75 mm	blue transparent	5.30.759.028/0000
5.25 mm	yellow orange transparent	5.30.759.030/0000
4.50 mm	red	5.30.759.027/0000
5.50 mm	yellow	5.30.759.031/0000
4 mm	green	5.30.759.025/0000
5.75 mm	green	5.30.759.032/0000
4.25 mm	blue	5.30.759.026/0000
6 mm	blue	5.30.759.033/0000
6.2 mm	blue	5.30.759.251/0000
5 mm	black	5.30.759.029/0000
10.00 mm	black	5.30.759.043/0104
6.25 mm	red	5.30.759.034/0000
6.50 mm	blue transparent	5.30.759.035/0000
6.75 mm	black	5.30.759.036/0000
7 mm	yellow orange transparent	5.30.759.037/0000
7.25 mm	yellow	5.30.759.038/0000
7.50 mm	green	5.30.759.039/0000
7.75 mm	blue	5.30.759.040/0000
8 mm	red	5.30.759.041/0000
8.25 mm	blue transparent	5.30.759.042/0000

Required spacer length

For keyboards: Overall height of key - front panel thickness - 0.5 mm (area embossing).

For RAFIX 22 FS: 9.25 mm - front panel thickness - thickness of overlay, if existing

PCB KEY SWITCHES

RF 15/19 - SPECIAL ACCESSORIES



Spacer, triangular

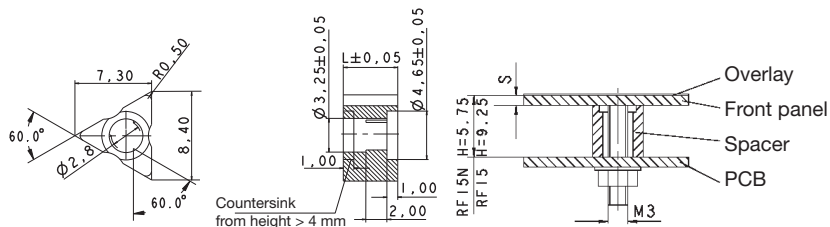

triangular version

→ Length L

Order no.

2.50 mm	5.30.759.094/0000
2.75 mm	5.30.759.095/0000
3 mm	5.30.759.096/0000
3.25 mm	5.30.759.097/0000
3.50 mm	5.30.759.098/0000
3.75 mm	5.30.759.099/0000
4 mm	5.30.759.100/0000
4.25 mm	5.30.759.101/0000
4.50 mm	5.30.759.102/0000
4.75 mm	5.30.759.103/0000
5 mm	5.30.759.104/0000
5.25 mm	5.30.759.105/0000
5.50 mm	5.30.759.106/0000
5.75 mm	5.30.759.107/0000
6 mm	5.30.759.108/0000
6.2 mm	5.30.759.253/0000
10.00 mm	5.30.759.124/0000
10.25 mm	5.30.759.125/0000
6.25 mm	5.30.759.109/0000
6.50 mm	5.30.759.110/0000
6.75 mm	5.30.759.111/0000
7 mm	5.30.759.112/0000
7.25 mm	5.30.759.113/0000
7.50 mm	5.30.759.114/0000
7.75 mm	5.30.759.115/0000
8 mm	5.30.759.116/0000
8.25 mm	5.30.759.117/0000
9 mm	5.30.759.254/0000

4

RF

– Table (continued) –
Spacers, triangular

Required spacer length = Overall height of key - front panel thickness - 0.5 mm (area embossing).

RF 15 N LED spacer



→ Length	Width	Overall height	Diameter	Color	Order no.
2.2 mm	-	12.5 mm	5 mm	light grey	5.30.109.010/0756
12 mm	-	22.5 mm	5 mm	black	5.30.109.019/0105

PCB KEY SWITCHES

KN 19 - SHORT-TRAVEL MAIN SWITCH



KN 19

Short-travel main switch

Short-travel main switch for use in membrane keyboards under the overlay or with RK 90 keycaps, 250V, 4A max. A cut-out in the overlay is not required!

- All products are RoHS compliant.

PCB KEY SWITCHES

KN 19 - SHORT-TRAVEL MAIN SWITCH

Content

KN 19 - Short-travel main switches

4 - 103

KN 19 - Short-travel main switch

4 - 104

4

KN 19

KN 19 Short-travel main switches

→ The KN 19 makes it possible to implement a power switch directly in a low-profile data entry system. This eliminates the need for extra switches on the device and additional openings in the overlay. In this way, you can achieve an optimum of safety and a consistent design.

The contact opening widths comply with the VDE standards. The KN 19 can also be employed underneath RK 90 keycaps. Other actuation functions (momentary, latching/momentary) available on request.



Technical Data

→ General information

Recommended key grid 19.05 x 38.1 mm

→ Dimensions

Length 37.8 mm
Width 18.8 mm
Overall height 9.7 mm

→ Mechanical design

Mounting on PCB
Terminals THT solder terminals
Contact system snap-action bridge contact
Contact arrangement see order block
Contact materials Ag
Illumination 1 LED (max. 3 mm) possible
Degree of protection IP40 (DIN EN 60529)
Hot wire ignition acc. to IEC 60695-2-1 850 °C

→ Mechanical characteristics

Operating force max. $9^{\pm 3}$ N
Operating travel $0.55^{\pm 0.15}$ mm
Robustness max. 100 N

→ Electrical characteristics

Rated voltage AC min. 12 V
Rated voltage DC min. 12 V
Rated voltage AC max. 250 V
Rated voltage DC max. 50 V
Ohmic load AC 6 A
Ohmic load DC max. 10 A
Ohmic load DC min. 0.1 A
Contact resistance when new max. 50 mΩ
Capacity input current AC max. 100 A
Rated motor current AC 4 A
Rated filament lamp current AC 2.4 A
Bouncing time max. 10 ms

→ Other specifications

Ambient temp. operating min. -25 °C
Ambient temp. operating max. +70 °C
Environmental resistance acc. to IEC 60068-2-14, -30, -33 and -78
Operating life AC AC 250 V: 200.000 /2A; 100.000 /6A
Operating life DC 50,000(10 A / 50 V=)
Soldering time max. 3 s
Soldering temperature max. 350 °C
Flame class acc. to UL 94 UL 94 VO
ROHS compliant yes
REACH compliant yes

Approvals



IEC 61058



UL 508, C22.2 No. 14-M91



PCB KEY SWITCHES

KN 19 - SHORT-TRAVEL MAIN SWITCH

Accessories KN 19 - Short-travel main switch

→ Description	Photo	Order no.	Additional accessories see page
KN19 - Absorption rubber		5.30.729.009/0000	-

Circuit diagrams



1 NC + 1 NO

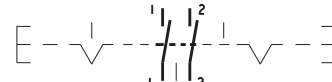

2 NC/2 NO

Dimensional drawing

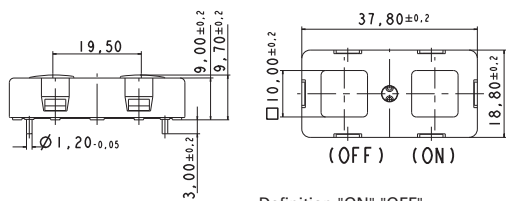

Definition "ON" "OFF"
only valid for 2-pole version.

PCB hole pattern

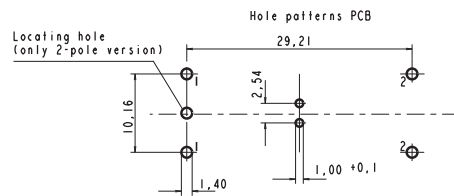

Locating hole only version 2 NO/2 NC

View on component side

4



KN 19 Short-travel main switch

Technical data see page 4 - 103

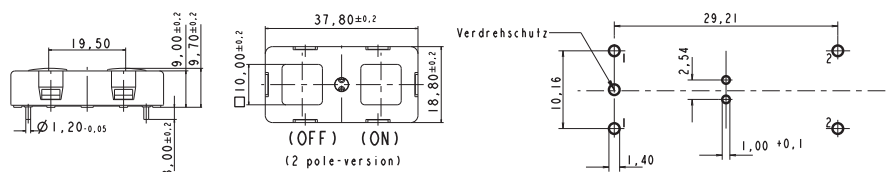

PCB footprint

→ Contact arrangement	Rated voltage AC max.	Order no.
1 NC + 1 NO	250 V	1.12.000.001/0000
2 NC / 2 NO	250 V	1.12.000.501/0000

For keycaps, refer to RK 90 system design.

Positive opening NC contacts to IEC 60 947-5-1.

1-LED spot-illumination (max. 3 mm) possible.

Accessoires:

KN19 - Absorption rubber: 5.30.729.009/0000

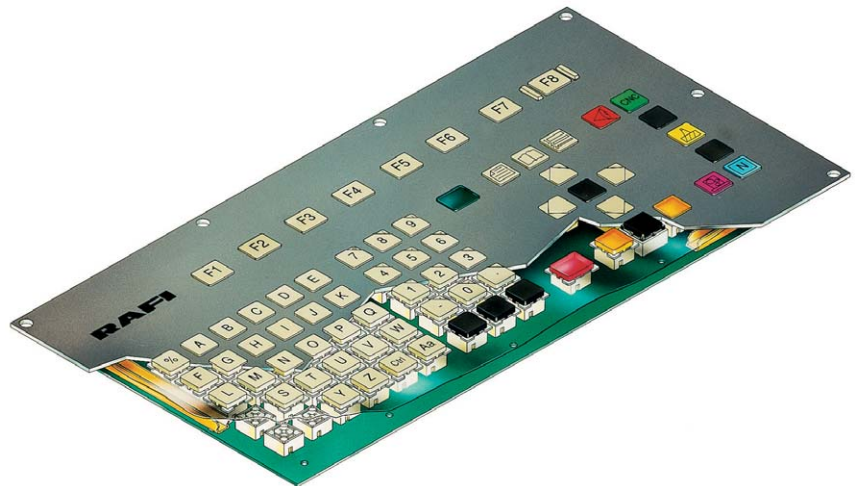

RK 90

Keycaps

Keycaps for RACON, RF 15 / RF 19 and KN 19 tactile switches

- You can insert a legend insert between lens and pressure pad of the transparent keycaps.
 - All products are RoHS compliant.
-

PCB KEY SWITCHES

RK 90 - KEYCAPS

Content

RK 90 - Keycaps, plastic, 9 x 9 mm	4 - 109
RK 90 - Keycap body plastic, for lenses 9 x 9 mm	4 - 110
RK 90 - Keycaps, plastic, 14 mm	4 - 111
RK 90 - Keycap body plastic, for lenses 14 mm, 1-module	4 - 112
RK 90 - Keycap body plastic, for lenses 1¼-module	4 - 112
RK 90 - Keycap body plastic, for lenses 14 mm, 1½-module	4 - 113
RK 90 - Keycap body plastic, for lenses 2-module	4 - 114
RK 90 - Keycaps, aluminum, 14 mm	4 - 115
RK 90 - Keycaps, aluminum, 14 mm, 1-module	4 - 116
RK 90 - Keycaps, aluminum, 14 mm, 1½-module	4 - 116
RK 90 - Keycaps, aluminum, 14 mm, 2-module	4 - 117
RK 90 - Special accessories	4 - 118
RK 90 - Fin, to avoid inadvertent operation	4 - 118
RK 90 - Spacer M 4	4 - 119
RK 90 - Silicone foil	4 - 119

Keycap system RK 90

Example with RF 15 key switches. Instead of RF 15 following key switches can be used:

- MICON 5
- RACON 8/12
- RF 15 tactile switches and signal indicators
- RF 19 tactile switches and signal indicators
- Short-travel main switch KN 19

The RK 90 system was granted the prize of the Design Forum of the Hannover Fair.

Degree of protection: IP65 according to DIN in front of the panel, with silicone sealing.

Installation methods

Installation from front

Installation from rear

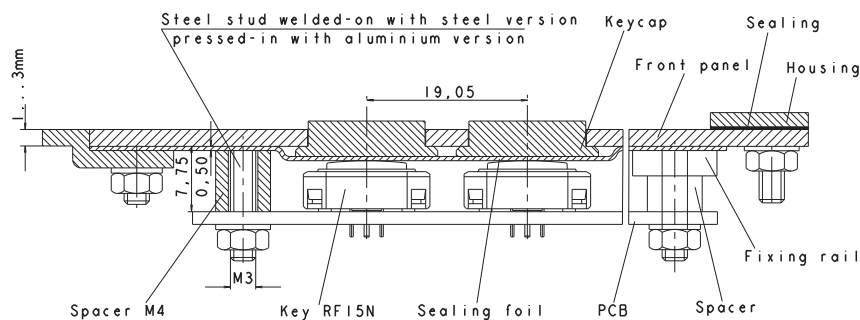

Mounting from front

Sealing foil between RK 90 keyboard and customer's front panel.

Mounting from rear

Sealing foil is screwed to RK 90 panel with fixing rails; sealing between keyboard and customer's front panel has to be provided.

Legending

- **Laser printing:** This labelling method is possible for opaque keycaps. The symbols are engraved in the keycaps with laser.
- When using transparent lenses, the pressure pad can be legended by printing.

As the legending is protected by the lens, it is friction-proof.

- **Engraving:** With this method the keycaps are engraved with the required symbol and then inlaid with ink.

PCB KEY SWITCHES

RK 90 - KEYCAP SYSTEM

Recommendations

- **Front panel thickness:**

- **Aluminum:** 2 mm (1.5 mm min, 3 mm max.)
(Fixing with M 3 pressed-in studs)

- **Steel:** 2 mm (3 mm max.); V2A: 1.25 mm
(Fixing with M 3 welded-on studs)

The keytop surface is flush with the keyboard at a panel thickness of 3.5 mm.

- **Silicone sealing:**

Material: Silicone transparent

Type: A-SY 40-79

Hardness: 30° shore +/- 5°

Thickness: 0.45 +/- 0.05 mm

- **Installation:** Ensure that the keyboard slopes slightly so that any liquid can drain away between front panel and silicone sealing; if necessary, provide additional drain holes in the front panel.

Cleaning liquids

For the cleaning of the plastic keycaps please do not use cleaning liquids based on alcohol or acid.

RK 90 Keycaps, plastic, 9 x 9 mm



Installation from front

Installation for rear

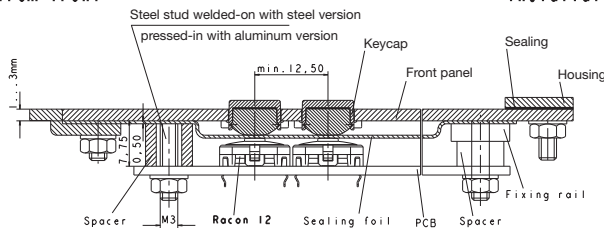

→ You can design especially small input fields with the small keycap 9 x 9 mm. For example, controls for measurement and laboratory equipment which do not offer much space for input fields because of their small size. RK 90 keycaps 9 x 9 mm and RACON tactile switches can be used to implement key grids of only 12.5 mm. The keycaps can be legended by laser-printing, engraving or standard printing.

This keycap is our first choice in a combination with the illuminated RACON 12 i tactile switch.

Please note: For the cleaning of the plastic keycaps please do not use cleaning liquids based on alcohol or acid.

Technical Data

→ General information

Color of lens	see order block
Size	1-module
Degree of protection (with silicon seal)	IP65 (DIN EN 60529)
Illuminability	see order block

→ Dimensions

Dimension keycap in front of front panel	8.85 x 8.85 mm
Dimension keycap behind front panel	11.5 x 11.5 mm
Dimension (c) hole patterns final size	9.00 x 9.00 mm
Dimension hole patterns punched size	9.20 x 9.20 mm

→ Other specifications

ROHS compliant	yes
REACH compliant	yes

Please order lens separately.

PCB KEY SWITCHES

RK 90 - KEYCAPS, PLASTIC, 9 X 9 MM

RK 90 Keycap body plastic, for lenses 9 x 9 mm



Technical data see page 4 - 109

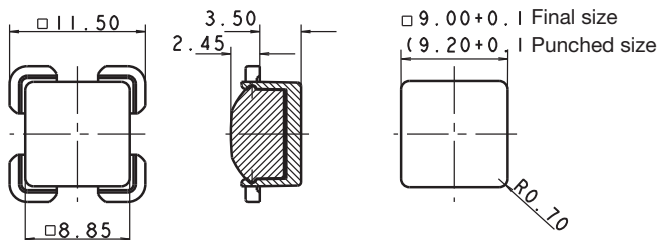

→ Size	Illuminability	Dimension keycap behind front panel	Dimension keycap in front of front panel	Dimension (c) hole patterns final size	Order no.
1-module	yes	11.5 x 11.5 mm	8.85 x 8.85 mm	9.00 x 9.00 mm	5.55.103.265/1013

Laser printed opaque lenses and keycap sets on request.

Please order lenses separately.

Lenses:

- RK 90 - Lens, 9 x 9 mm, opaque red: 5.46.651.015/0309
- RK 90 - Lens, 9 x 9 mm, opaque yellow: 5.46.651.015/0409
- RK 90 - Lens, 9 x 9 mm, opaque green: 5.46.651.015/0514
- RK 90 - Lens, 9 x 9 mm, opaque blue: 5.46.651.015/0611
- RK 90 - Lens, 9 x 9 mm, opaque light grey: 5.46.651.015/0700
- RK 90 - Lens, 9 x 9 mm, transparent colorless: 5.46.651.019/1002
- RK 90 - Lens, 9 x 9 mm, transparent red: 5.46.651.019/1307
- RK 90 - Lens, 9 x 9 mm, transparent yellow: 5.46.651.019/1403
- RK 90 - Lens, 9 x 9 mm, transparent green: 5.46.651.019/1510

RK 90 Keycaps, plastic, 14 mm

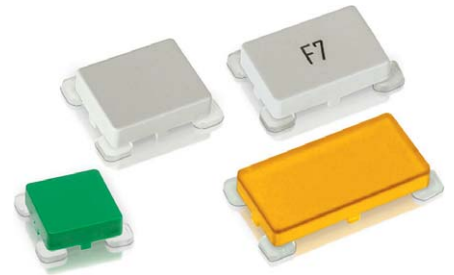

Installation from front Installation from rear

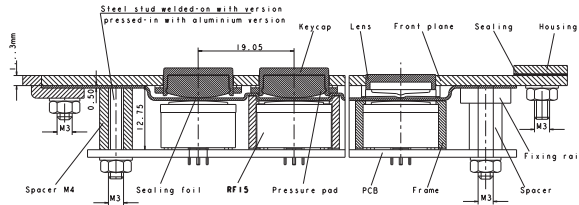

- Keycap system for 19.05 mm grid. The keycaps can be legended by laser-printing, engraving or standard printing. Keycaps / sets with legends and other keycap shapes / colors available on request.
Please note: For the cleaning of the plastic keycaps please do not use cleaning liquids based on alcohol or acid.

Technical Data

→ General information

Color of lens	see order block
Size	see order block
Degree of protection (with silicon seal)	IP65 (DIN EN 60529)
Illuminability	yes

→ Dimensions

Dimension (b) in front of front panel	see order block
Dimension (a) behind front panel	see order block
Dimension (c) hole patterns final size	see order block
Dimension hole patterns punched size	see order block

→ Other specifications

ROHS compliant	yes
REACH compliant	yes

PCB KEY SWITCHES

RK 90 - KEYCAPS, PLASTIC 14 MM



RK 90 Keycap body plastic, for lenses 14 mm, 1-module

Technical data see page 4 - 111

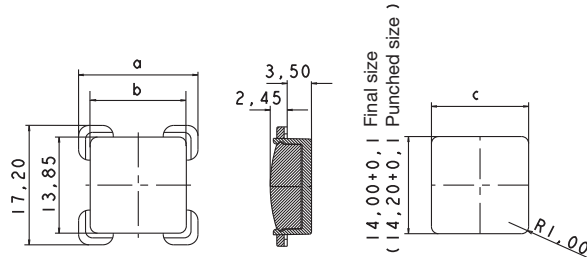

→ Size	Illuminability	Dimension (a) behind front panel	Dimension (b) in front of front panel	Dimension (c) hole patterns final size	Order no.
1-module	yes	17.20 x 17.20 mm	13.85 x 13.85 mm	14.00 x 14.00 mm	5.55.103.030/1013

Lenses:

- RK 90 - Lens, 14 x 14 mm, 1-module, opaque red: 5.46.681.001/0309
- RK 90 - Lens, 14 x 14 mm, 1-module, opaque yellow: 5.46.681.001/0409
- RK 90 - Lens, 14 x 14 mm, 1-module, opaque green: 5.46.681.001/0514
- RK 90 - Lens, 14 x 14 mm, 1-module, opaque blue: 5.46.681.001/0611
- RK 90 - Lens, 14 x 14 mm, 1-module, opaque light grey: 5.46.681.001/0700
- RK 90 - Lens, 14 x 14 mm, 1-module, transparent colorless: 5.46.681.021/1002
- RK 90 - Lens, 14 x 14 mm, 1-module, transparent red: 5.46.681.021/1307
- RK 90 - Lens, 14 x 14 mm, 1-module, transparent yellow: 5.46.681.021/1403
- RK 90 - Lens, 14 x 14 mm, 1-module, transparent green: 5.46.681.021/1510

4



RK 90 Keycap body plastic, for lenses 1 ¼-module

Technical data see page 4 - 111

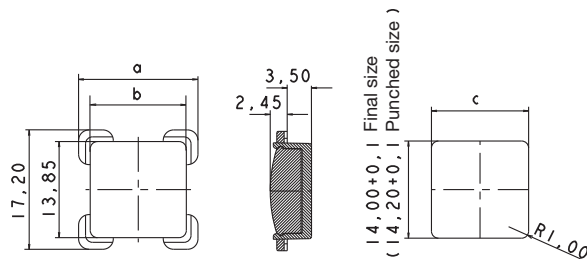

→ Size	Illuminability	Dimension (a) behind front panel	Dimension (b) in front of front panel	Dimension (c) hole patterns final size	Order no.
1 ¼-module	yes	17.20 x 20.7 mm	13.85 x 17.35 mm	14,00 x 17,5 mm	5.55.103.031/1013

Lenses:

- RK 90 - Lens, 14 mm, 1.25-module, opaque red: 5.46.681.002/0309

– Table (continued) –

RK 90 - Keycap body plastic, for lenses 1¼-module

- RK 90 - Lens, 14 mm, 1.25-module, opaque light grey: 5.46.681.002/0700
- RK 90 - Lens, 14 mm, 1.25-module, transparent colorless: 5.46.681.022/1002
- RK 90 - Lens, 14 mm, 1.25-module, transparent red: 5.46.681.022/1307
- RK 90 - Lens, 14 mm, 1.25-module, transparent yellow: 5.46.681.022/1403
- RK 90 - Lens, 14 mm, 1.25-module, transparent green: 5.46.681.022/1510

RK 90 Keycap body plastic, for lenses 14 mm, 1½-module

Technical data see page 4 - 111

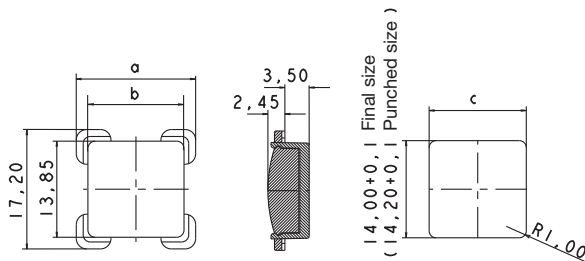

→ Size	Illuminability	Dimension (a) behind front panel	Dimension (b) in front of front panel	Dimension (c) hole patterns final size	Order no.
1½-module	yes	17.20 x 24.20 mm	13.85 x 20.85 mm	14.00 x 21.00 mm	5.55.103.032/1013

Lenses:

- RK 90 - Lens, 14 mm, 1.5-module, opaque red: 5.46.681.003/0309
- RK 90 - Lens, 14 mm, 1.5-module, opaque yellow: 5.46.681.003/0409
- RK 90 - Lens, 14 mm, 1.5-module, opaque green: 5.46.681.003/0514
- RK 90 - Lens, 14 mm, 1.5-module, opaque blue: 5.46.681.003/0611
- RK 90 - Lens, 14 mm, 1.5-module, opaque light grey: 5.46.681.003/0700
- RK 90 - Lens, 14 mm, 1.5-module, transparent colorless: 5.46.681.023/1002
- RK 90 - Lens, 14 mm, 1.5-module, transparent red: 5.46.681.023/1307
- RK 90 - Lens, 14 mm, 1.5-module, transparent yellow: 5.46.681.023/1403
- RK 90 - Lens, 14 mm, 1.5-module, transparent green: 5.46.681.023/1510

PCB KEY SWITCHES

RK 90 - KEYCAPS, PLASTIC 14 MM

RK 90

Keycap body plastic, for lenses 2-module



Technical data see page 4 - 111

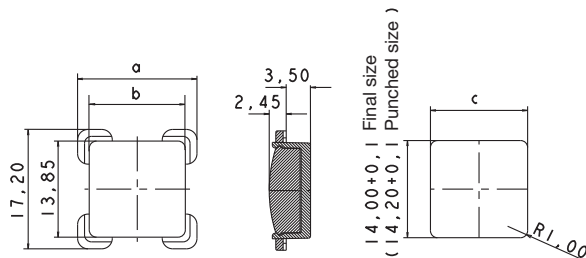

→ Size	Illuminability	Dimension (a) behind front panel	Dimension (b) in front of front panel	Dimension (c) hole patterns final size	Order no.
2-module	yes	17.20 x 31.20 mm	13.85 x 27.85 mm	14.00 x 28.00 mm	5.55.103.077/1013

Lenses:

- RK 90 - Lens, 14 mm, 2-module, opaque red: 5.46.681.004/0309
- RK 90 - Lens, 14 mm, 2-module, opaque yellow: 5.46.681.004/0409
- RK 90 - Lens, 14 mm, 2-module, opaque green: 5.46.681.004/0514
- RK 90 - Lens, 14 mm, 2-module, opaque blue: 5.46.681.004/0611
- RK 90 - Lens, 14 mm, 2-module, opaque light grey: 5.46.681.004/0700
- RK 90 - Lens, 14 mm, 2-module, transparent colorless: 5.46.681.024/1002
- RK 90 - Lens, 14 mm, 2-module, transparent red: 5.46.681.024/1307
- RK 90 - Lens, 14 mm, 2-module, transparent yellow: 5.46.681.024/1403
- RK 90 - Lens, 14 mm, 2-module, transparent green: 5.46.681.024/1510

RK 90 Keycaps, aluminum, 14 mm

- The RK 90 system design with metal keycaps is fairly safe against mechanical, thermal or chemical effects. Combined with a metal front panel, this data entry system offers maximum protection against vandalism. Tried and tested MICON 5, RACON 8/12 or RF 15/19 PCB key switches are used underneath the metal keycaps.
- The keycaps can be provided with engraved, colored anodized or laser-printed legends. This means that the legend is durable and cannot be removed by mechanical or chemical means.



Technical Data

→ General information

Color of lens	aluminum colorless anodized
Size	see order block
Degree of protection (with silicon seal)	IP65 (DIN EN 60529)

→ Dimensions

Dimension (b) in front of front panel	see order block
Dimension (a) behind front panel	see order block
Dimension (c) hole patterns final size	see order block
Dimension hole patterns punched size	see order block

→ Other specifications

ROHS compliant	yes
REACH compliant	yes

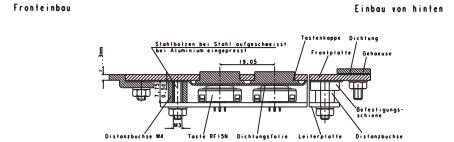
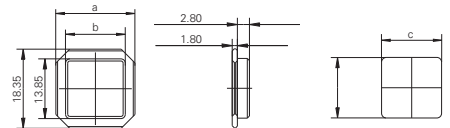

PCB KEY SWITCHES

RK 90 - KEYCAPS, ALUMINIUM, 14 MM



RK 90 Keycaps, aluminum, 14 mm, 1-module

Technical data see page 4 - 115

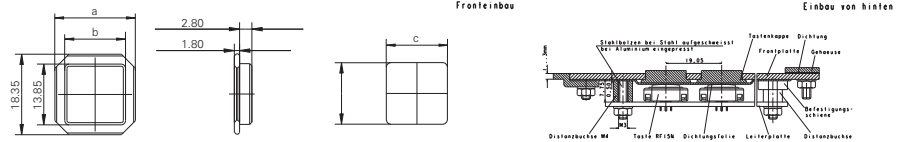

→ Size	Color of lens	Dimension (a) behind front panel	Dimension (b) in front of front panel	Dimension (c) hole patterns final size	Order no.
1-module	aluminum colorless anodized	18.35 x 18.35 mm	13.85 x 13.85 mm	14.00 x 14.00 mm	5.46.500.001/4010



RK 90 Keycaps, aluminum, 14 mm, 1½-module

Technical data see page 4 - 115

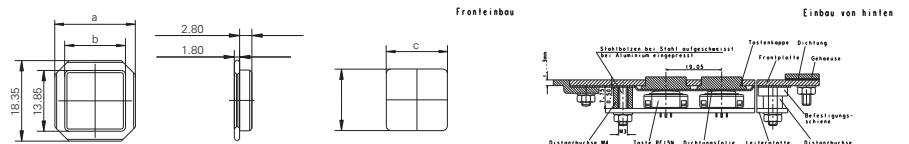

→ Size	Color of lens	Dimension (a) behind front panel	Dimension (b) in front of front panel	Dimension (c) hole patterns final size	Order no.
1½-module	aluminum colorless anodized	18.35 x 25.35 mm	13.85 x 20.85 mm	14.00 x 21.00 mm	5.46.500.003/4010

4

RK 90

RK 90 Keycaps, aluminum, 14 mm, 2-module

Technical data see page 4 - 115

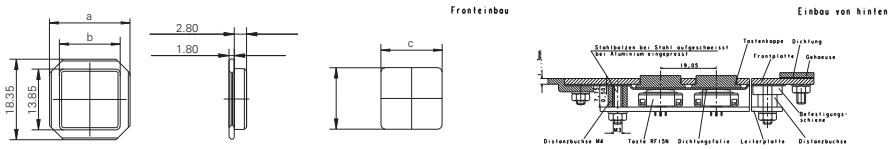

→ Size	Color of lens	Dimension (a) behind front panel	Dimension (b) in front of front panel	Dimension (c) hole patterns final size	Order no.
2-module	aluminum colorless anodized	18.35 x 32.35 mm	13.85 x 27.85 mm	14.00 x 28.00 mm	5.46.500.004/4010



RK 90 Special accessories

RK 90 Fin, to avoid inadvertent operation

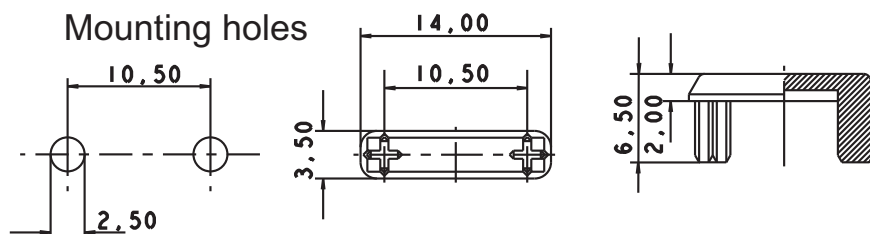

→ Description

Color

Order no.

RK 90 - Fin, to avoid inadvertent operation, light grey

opaque light grey

5.55.103.079/0700

RK 90 - Fin, to avoid inadvertent operation, charcoal grey

opaque light grey

5.55.103.079/0152

RK 90 Spacer M 4



→ Length L	Color	Order no.
12.5 mm overall height for RF 15 mm	-	5.30.764.040/0000
9.25 mm overall height, for RF 15 mm	-	5.30.764.027/0000
5.5 mm overall height, for RF15 N mm	-	5.30.764.010/0000
7.5 mm overall height for RACON 8/12 mm	-	5.30.764.018/0000
4.25 mm overall height, for RACON 8/12 mm	-	5.30.764.005/0000

Mounting from front (1 pc. per stud)

RK 90 Silicone foil



→ Color	Dimensions	Order no.
transparent	600 x 590 x 0.45 mm	7.16.102.006/0000

PCB KEY SWITCHES

RG 85 III - PUSHBUTTONS/KEYS



RG 85 III

Short-travel system

Vandal-proof input system, ideally suited for elevator controls, info terminals, vending machines, etc.

- Edge illumination and symbol illumination possible
- Connection: Each module individually with an 8-pin Micro-Match socket connector
- Modular fixing system with quick fasteners or single fixing
- Contact arrangement: 1 NO contact
- 35 V/250 mA max.
- Degree of protection IP65 (keylock switch IP40).
- Elevator standardm EN 81-70
- All products are RoHS compliant.

4

RG
85 III

PCB KEY SWITCHES

RG 85 III - PUSHBUTTONS/KEYS

Content

RG 85 III - Key switches	4 - 125
RG 85 III - Key switch, round design, without lens	4 - 126
RG 85 III - Key switch, square design, without lens	4 - 126
RG 85 III - Keylock switches	4 - 128
RG 85 III - Keylock switch, round design, without lens	4 - 129
RG 85 III - Keylock switch, square design, without lens	4 - 129
RG 85 III - Signal indicators, without lens	4 - 131
RG 85 III - Signal indicator, without lens	4 - 132
RG 85 III - Accessories	4 - 133
RG 85 III - Lens for key switches, round	4 - 133
RG 85 III - Lens for key switches, square	4 - 134
RG 85 III - Lens for key switches, round flush, elevator standard EN 81-70	4 - 135
RG 85 III - Lens for key switches, round protruding, elevator standard EN 81-70	4 - 136
RG 85 III - Lens for key switches, square flush, elevator standard EN 81-70	4 - 137
RG 85 III - Lens for key switches, square protruding, elevator standard EN 81-70	4 - 138
RG 85 III - Lens for keylock switches, round	4 - 139
RG 85 III - Lens for keylock switches, square	4 - 139
RG 85 III - Lens, round, for signal indicators	4 - 140
RG 85 III - Lens, square, for signal indicators	4 - 140
RG 85 III - Lens, triangular, for signal indicators	4 - 141
Cable, 8 wire, with socket connectors on both ends	4 - 141
Fixing rail, length 490 mm	4 - 142
Spacer	4 - 142
Fixing piece for mounting the elements with the rail fixing method	4 - 142

System Features

Perfectly suited for: elevator controls, info terminals, vending machines, etc.

- Vandal proof construction
- Modular fixing system with quick fasteners or single fixing method using thread studs
- Connection with keyed 8-pin micro-match connector
- Degree of protection: IP40/65

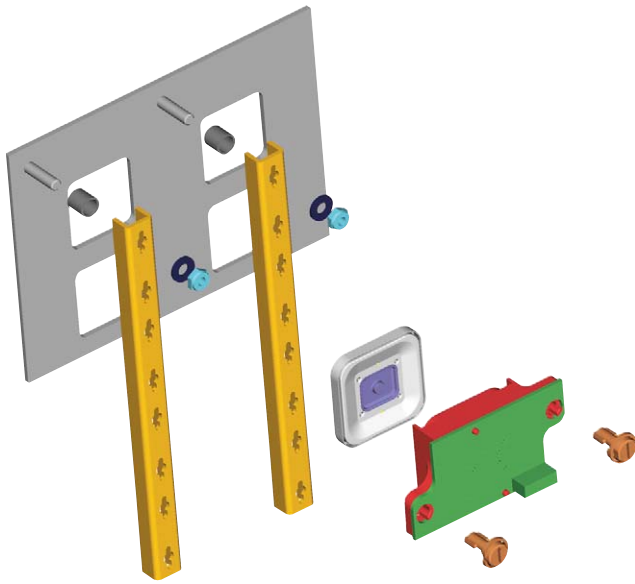

Keylock Switch Features

- Round or square design and lens shape
- Edge illumination in one or two colours with 4 LED for each colour
- Lens material: Aluminum or stainless steel with plastic inlays
- Contact arrangement: 1 NO
- Cylinder lock with pin tumblers
- Two switching positions: 0 and 90 degrees, key can be removed in any position
- Lock type 5201 – other lock types on request
- Included: 2 keys

Micro-Match Connector Pin Assignment

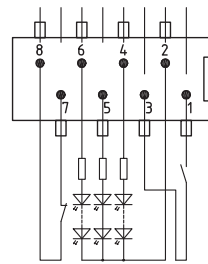

1/3 NO contact

2 OV – LED

4 Edge illuminat./signal indicator
1st colour + 24 V DC +/- 20%

5 Symbol illumination
+ 24 V DC±20%

6 Edge illuminat./signal indicator
2nd colour + 24 V DC +/- 20%

7/8 NC contact

Pushbutton Features

- Round or square design and lens shape
- Edge illumination in one or two colours with 4 LED for each colour
- Additional illumination of the symbol with 2 LED
- Lens material: Aluminum or stainless steel with plastic inlays
- Switching element: short-travel key switch RF 19
 - 1 NO contact, non-illuminated
 - 1 NO contact, fully illuminated

Signal Indicator Features

- Lens shape round, square or triangular (arrow shape)
- Lens material: Translucent plastic material
- Fully illuminated with 5 LED

PCB KEY SWITCHES

RG 85 III - PUSHBUTTONS/KEYS

Installation plan

Rail fixing method

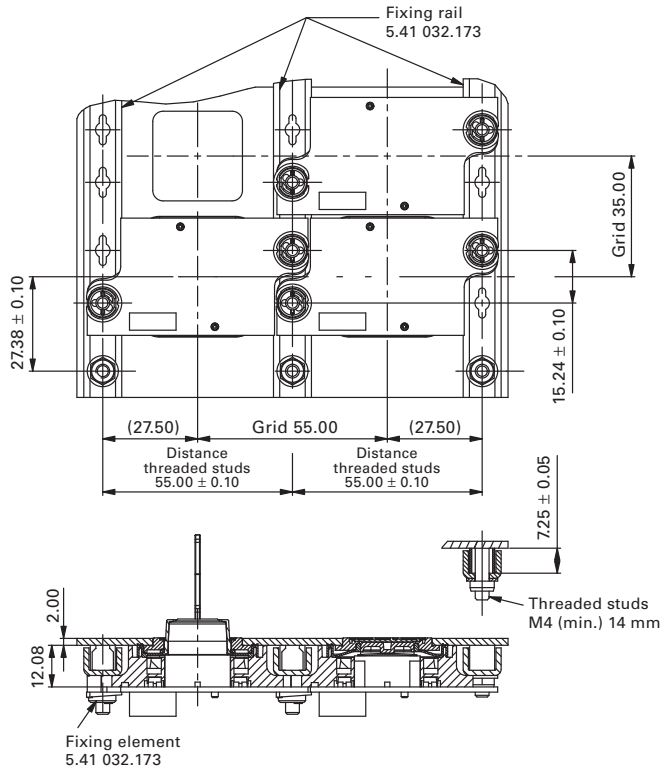

Single fixing method

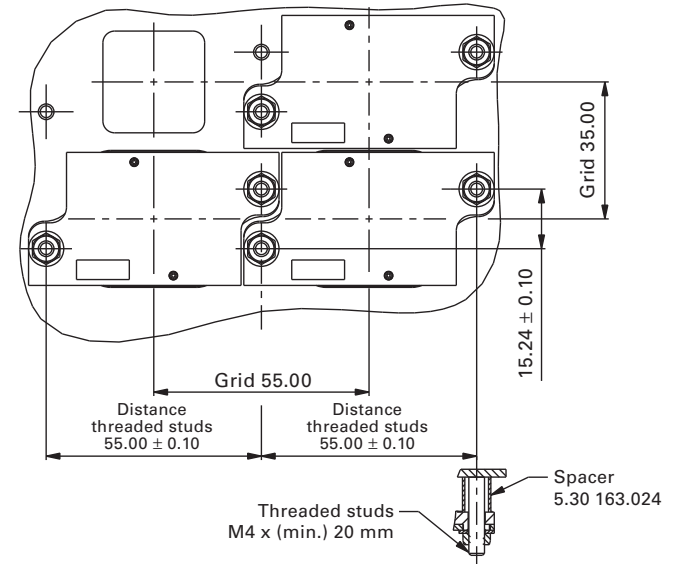

4

Front panel

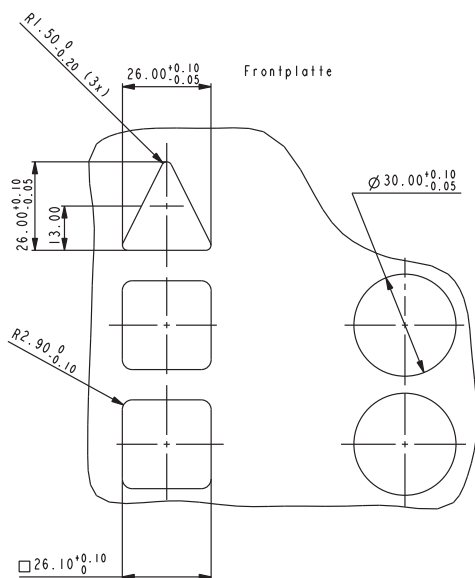

RG 85 III



RG 85 III Key switches

Technical Data

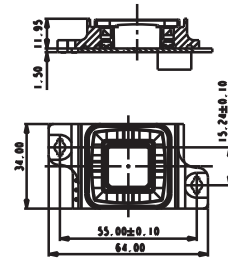
→ Dimensions	
Length	64 mm
Mounting grid min.	55 x 35 mm
Width	34 mm
→ Mechanical design	
Version	see order block
Mounting	on U-rails or single mounting
Terminals	8-pin Micro-Match® female connector
Contact system	snap-action contact
Contact arrangement	see order block
Contact materials	Ag
Symbol illumination	see order block
Edge illumination	see order block
→ Mechanical characteristics	
Operating force	3.5 N
Operating travel	1 mm
Switching travel NO	1 mm
Switching travel NC	0.6 mm
→ Electrical characteristics	
Rated voltage min.	3 V
Rated voltage max.	35 V
Rated current min.	0.1 mA
Rated current max.	250 mA
Rated power max.	12.5 W
Contact resistance when new max.	100 mΩ
Contact resistance acc. to life max.	3 Ω
Bouncing time max.	10 ms
Operating voltage for LED	24 ^{+20%} V
Input current LED	per color/LED row 9 - 16 mA
→ Other specifications	
Ambient temp. operating min.	-25 °C
Ambient temp. operating max.	+70 °C
Storage temperature min.	-40 °C
Storage temperature max.	+80 °C
Environmental resistance	acc. to IEC 60068-2-14, -30, -33 and -78
Operating life min. (operations)	1,000,000
Degree of protection rail mounting	IP40 (DIN EN 60529)
Degree of protection single mounting	IP65 (DIN EN 60529)
Flammability of materials	according to UL 94 HB
ROHS compliant	yes
REACH compliant	yes



Accessories RG 85 III - Key switch

Description	Photo	Order no.	Additional accessories see page
Cable, 8 wires, with socket connectors on both ends, length 1 m		5.03.772.261/0000	4 - 141
RG 85 III - Lenses for key switches, round, stainless steel		5.04.914.000/2000	4 - 133
RG 85 III - Lenses for key switches, square, aluminum		5.04.915.100/2000	4 - 134

PCB KEY SWITCHES

RG 85 III - PUSHBUTTONS/KEYS

– Table (continued) –
RG 85 III - Key switch, square design, without lens

→ Contact arrangement	Edge illumination	Symbol illumination	Version	Order no.
1 NO	4 LED green	2 LED green	square	3.99.400.112/5500
1 NO	4 LED blue	2 LED blue	square	3.99.400.112/6600
1 NO	4 LED white, 4 LED blue	2 LED blue	square	3.99.400.112/7600
1 NO	4 LED green, 4 LED red	2 LED red	square	3.99.400.112/8300

Please order lenses (square shape) separately.

PCB KEY SWITCHES

RG 85 III - KEYLOCK SWITCHES

RG 85 III Keylock switches

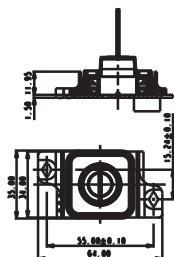

Technical Data

→ Dimensions

Length	64 mm
Mounting grid min.	55 x 35 mm
Width	34 mm (35 mm with sealing)

→ Mechanical design

Version	see order block
Mounting	on U-rails or single mounting
Terminals	8-pin Micro-Match® female connector
Contact system	cross contact
Contact arrangement	1 NO
Contact materials	Au alloy
Symbol illumination	none
Edge illumination	see order block
Lock	cylinder lock, lock type 5201
Key removal position	Pos. 0 + 1

→ Mechanical characteristics

Rotating angle	1 x 90°
Switching travel NO	1 mm

→ Electrical characteristics

Rated voltage min.	3 V
Rated voltage max.	35 V
Rated current min.	0.1 mA
Rated current max.	100 mA
Rated power max.	1 W
Contact resistance when new max.	100 mΩ
Contact resistance acc. to life max.	3 Ω
Bouncing time max.	10 ms
Operating voltage for LED	24 ^{+20%} V
Input current LED	per color/LED row 9 - 16 mA

→ Other specifications

Ambient temp. operating min.	-25 °C
Ambient temp. operating max.	+70 °C
Storage temperature min.	-40 °C
Storage temperature max.	+80 °C
Environmental resistance	acc. to IEC 60068-2-14, -30, -33 and -78
Operating life min. (operations)	50,000
Degree of protection rail mounting	IP40 (DIN EN 60529)
Degree of protection single mounting	IP65 (DIN EN 60529)
Flammability of materials	according to UL 94 HB
ROHS compliant	yes
REACH compliant	yes

4

Accessories RG 85 III - Keylock switch

→ Description	Photo	Order no.	Additional accessories see page
RG 85 III - Lenses for keylock switches, round, stainless steel		5.04.914.200/2000	4 - 139
RG 85 III - Lenses for keylock switches, square, aluminum		5.04.915.201/2000	4 - 139

RG
85 III

RG 85 III Keylock switch, round design, without lens

Technical data see page 4 - 128

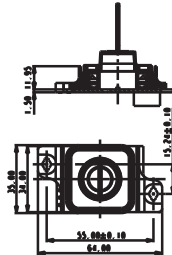

→ Contact arrangement	Edge illumination	Rotating angle	Version	Order no.
1 NO	4 LED white	1 x 90°	round	3.99.400.141/2000
1 NO	4 LED red	1 x 90°	round	3.99.400.141/3000
1 NO	4 LED green	1 x 90°	round	3.99.400.141/5000
1 NO	4 LED blue	1 x 90°	round	3.99.400.141/6000

Please order lenses (round shape) separately.

Accessoires:

RG 85 III - Lenses for keylock switches, round, stainless steel: 5.04.914.200/2000

RG 85 III Keylock switch, square design, without lens

Technical data see page 4 - 128

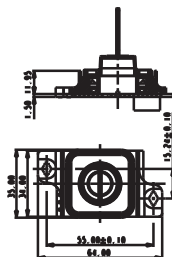

→ Contact arrangement	Edge illumination	Rotating angle	Version	Order no.
1 NO	4 LED white	1 x 90°	square	3.99.400.142/2000
1 NO	4 LED red	1 x 90°	square	3.99.400.142/3000
1 NO	4 LED green	1 x 90°	square	3.99.400.142/5000
1 NO	4 LED blue	1 x 90°	square	3.99.400.142/6000

PCB KEY SWITCHES

RG 85 III - KEYLOCK SWITCHES

– Table (continued) –

RG 85 III - Keylock switch, square design, without lens

Please order lenses (square shape) separately.

Accessoires:

RG 85 III - Lenses for keylock switches, square, stainless steel: 5.04.914.201/2000

RG 85 III Signal indicators, without lens

Technical Data

→ Dimensions	
Length	64 mm
Mounting grid min.	55 x 35 mm
Width	34 mm
→ Mechanical design	
Version	according to lens
Mounting	on U-rails or single mounting
Terminals	8-pin Micro-Match® female connector
Illumination	see order block
→ Electrical characteristics	
Operating voltage for LED	24 \pm 20% V
Input current LED	depending on LED color 20 - 30 mA
→ Other specifications	
Ambient temp. operating min.	-25 °C
Ambient temp. operating max.	+70 °C
Storage temperature min.	-40 °C
Storage temperature max.	+80 °C
Environmental resistance	acc. to IEC 60068-2-14, -30, -33 and -78
Degree of protection rail mounting	IP40 (DIN EN 60529)
Degree of protection single mounting	IP65 (DIN EN 60529)
Flammability of materials	according to UL 94 HB
ROHS compliant	yes
REACH compliant	yes

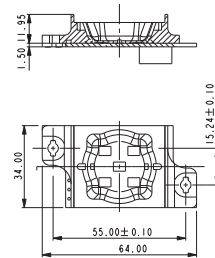

Accessories RG 85 III - Signal indicator, without lens

Description	Photo	Order no.	Additional accessories see page
Cable, 8 wires, with socket connectors on both ends, length 2 m		5.03.772.262/0000	4 - 141
RG 85 III - Lens, square, for signal indicators		5.04.903.009/0000	4 - 140
RG 85 III - Lens, round, for signal indicators		5.04.903.010/0000	4 - 140
RG 85 III - Lens, triangular, for signal indicators		5.04.903.011/0000	4 - 141

PCB KEY SWITCHES

RG 85 III - SIGNAL INDICATOR

RG 85 III Signal indicator, without lens



Technical data see page 4 - 131

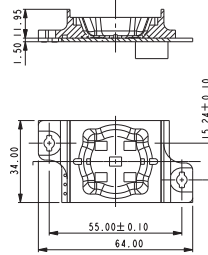

→ Illumination	Order no.
5 LED white	3.99.400.100/2000
5 LED red	3.99.400.100/3000
5 LED green	3.99.400.100/5000
5 LED green, 5 LED red	3.99.400.100/8000

Please order round, square or triangular lenses separately.

RG 85 III Accessories



RG 85 III Lens for key switches, round



→ Version	Form of lens	Legending color	Legending	Order no.
aluminum	round	-	-	5.04.915.000/2000
stainless steel	round	-	-	5.04.914.000/2000

The lenses without legending can not be engraved - other than the mentioned legends on request.

PCB KEY SWITCHES

RG 85 III - SPECIAL ACCESSORIES

RG 85 III Lens for key switches, square



→ Version	Form of lens	Legending color	Legending	Order no.
aluminum	square	-	-	5.04.915.100/2000
stainless steel	square	-	-	5.04.914.100/2000
stainless steel	square	opaque yellow	symbol „bell“	5.04.914.124/0400
stainless steel	square	opaque black	1	5.04.914.101/0100
stainless steel	square	opaque black	2	5.04.914.102/0100
stainless steel	square	opaque black	3	5.04.914.103/0100
stainless steel	square	opaque black	4	5.04.914.104/0100
stainless steel	square	opaque black	5	5.04.914.105/0100
stainless steel	square	opaque black	6	5.04.914.106/0100
stainless steel	square	opaque black	U	5.04.914.121/0100
stainless steel	square	opaque black	K	5.04.914.122/0100
stainless steel	square	opaque black	E	5.04.914.123/0100
stainless steel	square	opaque black	symbol „open door“	5.04.914.125/0100
stainless steel	square	opaque black	symbol „close door“	5.04.914.126/0100
stainless steel	square	opaque black	symbol „ventilator“	5.04.914.127/0100
stainless steel	square	opaque black	symbol „arrow“	5.04.914.128/0100
stainless steel	square	translucent white	1	5.04.914.101/2000
stainless steel	square	translucent white	2	5.04.914.102/2000
stainless steel	square	translucent white	3	5.04.914.103/2000
stainless steel	square	translucent white	4	5.04.914.104/2000
stainless steel	square	translucent white	5	5.04.914.105/2000
stainless steel	square	translucent white	6	5.04.914.106/2000
stainless steel	square	translucent white	U	5.04.914.121/2000
stainless steel	square	translucent white	K	5.04.914.122/2000
stainless steel	square	translucent white	E	5.04.914.123/2000
stainless steel	square	translucent white	symbol „open door“	5.04.914.125/2000
stainless steel	square	translucent white	symbol „close door“	5.04.914.126/2000
stainless steel	square	translucent white	symbol „ventilator“	5.04.914.127/2000
stainless steel	square	translucent white	symbol „arrow“	5.04.914.128/2000

4

RG
85 III

– Table (continued) –
RG 85 III - Lenses for key switches, square

The lenses without legending can not be engraved - other than the mentioned legends on request.

RG 85 III Lens for key switches, round flush, elevator standard EN 81-70



→ Version	Form of lens	Legending color	Legending	Order no.
stainless steel	round	-	-	5.04.916.000/2000
stainless steel	round	opaque yellow	symbol „bell“	5.04.916.024/1404
stainless steel	round	translucent white	1	5.04.916.001/2000
stainless steel	round	translucent white	2	5.04.916.002/2000
stainless steel	round	translucent white	3	5.04.916.003/2000
stainless steel	round	translucent white	4	5.04.916.004/2000
stainless steel	round	translucent white	5	5.04.916.005/2000
stainless steel	round	translucent white	6	5.04.916.006/2000
stainless steel	round	translucent white	U	5.04.916.021/2000
stainless steel	round	translucent white	K	5.04.916.022/2000
stainless steel	round	translucent white	E	5.04.916.023/2000
stainless steel	round	translucent white	symbol „open door“	5.04.916.025/2000
stainless steel	round	translucent white	symbol „close door“	5.04.916.026/2000
stainless steel	round	translucent white	symbol „arrow“	5.04.916.033/2000
stainless steel	round	translucent white	symbol „ventilator“	5.04.916.034/2000
stainless steel	round	translucent white	7	5.04.916.007/2000
stainless steel	round	translucent white	8	5.04.916.008/2000
stainless steel	round	translucent white	9	5.04.916.009/2000
stainless steel	round	translucent white	10	5.04.916.010/2000
stainless steel	round	translucent white	11	5.04.916.011/2000
stainless steel	round	translucent white	12	5.04.916.012/2000
stainless steel	round	translucent white	13	5.04.916.013/2000
stainless steel	round	translucent white	14	5.04.916.014/2000
stainless steel	round	translucent white	15	5.04.916.015/2000

PCB KEY SWITCHES

RG 85 III - SPECIAL ACCESSORIES

– Table (continued) –

RG 85 III - Lenses for key switches, round flush, elevator standard EN 81-70

→ Version	Form of lens	Legending color	Legending	Order no.
stainless steel	round	translucent white	16	5.04.916.016/2000
stainless steel	round	translucent white	17	5.04.916.017/2000
stainless steel	round	translucent white	18	5.04.916.018/2000
stainless steel	round	translucent white	19	5.04.916.019/2000
stainless steel	round	translucent white	20	5.04.916.020/2000
stainless steel	round	translucent white	0	5.04.916.027/2000
stainless steel	round	translucent white	-1	5.04.916.028/2000
stainless steel	round	translucent white	-2	5.04.916.029/2000
stainless steel	round	translucent white	-3	5.04.916.030/2000
stainless steel	round	translucent white	-4	5.04.916.031/2000
stainless steel	round	translucent white	-5	5.04.916.032/2000
stainless steel	round	transparent yellow	symbol „bell“	5.04.916.024/2214



RG 85 III Lens for key switches, round protruding, elevator standard EN 81-70

4

→ Version	Form of lens	Legending color	Legending	Order no.
stainless steel	round	opaque yellow	symbol „bell“	5.04.916.224/1404
stainless steel	round	opaque black	-	5.04.916.201/1501
stainless steel	round	opaque black	2	5.04.916.202/1501
stainless steel	round	opaque black	3	5.04.916.203/1501
stainless steel	round	opaque black	E	5.04.916.223/1501
stainless steel	round	opaque black	0	5.04.916.227/1501
stainless steel	round	opaque black	-1	5.04.916.228/1501
stainless steel	round	transparent yellow	symbol „bell“	5.04.916.224/2214

RG
85 III

RG 85 III Lens for key switches, square flush, elevator standard EN 81-70



→ Version	Form of lens	Legending color	Legending	Order no.
stainless steel	square	-	-	5.04.916.100/2000
stainless steel	square	opaque yellow	symbol „bell“	5.04.916.124/1404
stainless steel	square	translucent white	1	5.04.916.101/2000
stainless steel	square	translucent white	2	5.04.916.102/2000
stainless steel	square	translucent white	3	5.04.916.103/2000
stainless steel	square	translucent white	4	5.04.916.104/2000
stainless steel	square	translucent white	5	5.04.916.105/2000
stainless steel	square	translucent white	6	5.04.916.106/2000
stainless steel	square	translucent white	U	5.04.916.121/2000
stainless steel	square	translucent white	K	5.04.916.122/2000
stainless steel	square	translucent white	E	5.04.916.123/2000
stainless steel	square	translucent white	symbol „open door“	5.04.916.125/2000
stainless steel	square	translucent white	symbol „close door“	5.04.916.126/2000
stainless steel	square	translucent white	symbol „arrow“	5.04.916.133/2000
stainless steel	square	translucent white	symbol „ventilator“	5.04.916.134/2000
stainless steel	square	translucent white	7	5.04.916.107/2000
stainless steel	square	translucent white	8	5.04.916.108/2000
stainless steel	square	translucent white	9	5.04.916.109/2000
stainless steel	square	translucent white	10	5.04.916.110/2000
stainless steel	square	translucent white	11	5.04.916.111/2000
stainless steel	square	translucent white	12	5.04.916.112/2000
stainless steel	square	translucent white	13	5.04.916.113/2000
stainless steel	square	translucent white	14	5.04.916.114/2000
stainless steel	square	translucent white	15	5.04.916.115/2000
stainless steel	square	translucent white	16	5.04.916.116/2000
stainless steel	square	translucent white	17	5.04.916.117/2000
stainless steel	square	translucent white	18	5.04.916.118/2000
stainless steel	square	translucent white	19	5.04.916.119/2000
stainless steel	square	translucent white	20	5.04.916.120/2000

PCB KEY SWITCHES

RG 85 III - SPECIAL ACCESSORIES

– Table (continued) –

RG 85 III - Lenses for key switches, square flush, elevator standard EN 81-70

→ Version	Form of lens	Legending color	Legending	Order no.
stainless steel	square	translucent white	0	5.04.916.127/2000
stainless steel	square	translucent white	-1	5.04.916.128/2000
stainless steel	square	translucent white	-2	5.04.916.129/2000
stainless steel	square	translucent white	-3	5.04.916.130/2000
stainless steel	square	translucent white	-4	5.04.916.131/2000
stainless steel	square	translucent white	-5	5.04.916.132/2000
stainless steel	square	transparent yellow	symbol „bell“	5.04.916.124/2214



RG 85 III Lens for key switches, square protruding, elevator standard EN 81-70

4

→ Version	Form of lens	Legending color	Legending	Order no.
stainless steel	square	opaque yellow	symbol „bell“	5.04.916.254/1404
stainless steel	square	opaque black	1	5.04.916.231/1501
stainless steel	square	opaque black	2	5.04.916.232/1501
stainless steel	square	opaque black	3	5.04.916.233/1501
stainless steel	square	opaque black	E	5.04.916.253/1501
stainless steel	square	opaque black	0	5.04.916.257/1501
stainless steel	square	opaque black	-1	5.04.916.258/1501
stainless steel	square	transparent yellow	symbol „bell“	5.04.916.254/2214

RG
85 III

RG 85 III Lens for keylock switches, round



→ Version	Form of lens	Legending color	Legending	Order no.
aluminum	round	-	-	5.04.915.200/2000
stainless steel	round	-	-	5.04.914.200/2000

RG 85 III Lens for keylock switches, square



→ Version	Form of lens	Legending color	Legending	Order no.
aluminum	square	-	-	5.04.915.201/2000
stainless steel	square	-	-	5.04.914.201/2000

PCB KEY SWITCHES

RG 85 III - SPECIAL ACCESSORIES

RG 85 III Lens, round, for signal indicators



→ Version	Form of lens	Legending color	Legending	Order no.
plastic translucent	round	-	-	5.04.903.010/0000

RG 85 III Lens, square, for signal indicators



→ Version	Form of lens	Legending color	Legending	Order no.
plastic translucent	square	-	-	5.04.903.009/0000

4

RG
85 III

RG 85 III Lens, triangular, for signal indicators



→ Version	Form of lens	Legending color	Legending	Order no.
plastic translucent	triangular	-	-	5.04.903.011/0000

Cable, 8 wire, with socket connectors on both ends



→ Version	Order no.
length: 1 m	5.03.772.261/0000
length: 2 m	5.03.772.262/0000

PCB KEY SWITCHES

RG 85 III - SPECIAL ACCESSORIES

Fixing rail, length 490 mm



→ **Version**

Order no.

length: 490 mm

5.41.032.173/7500



Spacer

→ **Version**

Order no.

mounting on rails

5.30.163.021/6000

single mounting

5.30.163.024/6000



Fixing piece for mounting the elements with the rail fixing method

→ **Description**

Order no.

Fixing piece for mounting the elements with the rail fixing method

5.55.104.208/0459

4

RG
85 III

PCB KEY SWITCHES

RS 76 - FULL-TRAVEL KEY SWITCHES



RS 76

Full-travel key switches

The RS 76 full-travel key switches are designed for configuring keyboards. They offer very comfortable operation with an overall height of 15.5 / 15.9 mm and a key travel of 4 mm. The modular system with a grid of 3/4" = 19.05 mm enables you to design any key block you may want.

Mechanical contact system RS 76 M

A gold alloy is used as the contact material and provides high contact reliability, low contact resistance and short bouncing time.

Solid-state contact system RS 76 C

The solid-state switch in Hall-IC technology ensures bounce-free and wear-free switching and a long operating life. Function: When pressing the keys, a permanent magnet changes its position relative to the Hall-IC and thereby generates an output signal. Their use is especially recommended in hostile environments and for heavy duty applications.

- All products are RoHS compliant.

PCB KEY SWITCHES

RS 76 - FULL-TRAVEL KEY SWITCHES

Content

RS 76 M - Full-travel key switches, not illuminable	4 - 150
RS 76 M - Full-travel key switch, not illuminable	4 - 151
RS 76 M - Full-travel key switch, with diode, not illuminable	4 - 152
RS 76 M - Full-travel key switches, illuminable	4 - 153
RS 76 M - Full-travel key switch, illuminable, momentary	4 - 154
RS 76 M - Full-travel key switch, illuminable, latching	4 - 155
RS 76 MX - Full-travel key switch, fully illuminable	4 - 155
RS 76 C - Full-travel key switches, not illuminable	4 - 156
RS 76 C - Full-travel key switch, not illuminable	4 - 157
RS 76 C - Full-travel key switches, illuminable	4 - 158
RS 76 C - Full-travel key switch, illuminable, momentary	4 - 159
RS 76 C - Full-travel key switch, illuminable, latching	4 - 160
RS 76 - Keycaps, not illuminable	4 - 161
RS 76 C - Keycap, opaque	4 - 161
RS 76 C - Keycap, opaque, with nail protection	4 - 162
RS 76 C - Keycap with legend insert	4 - 162
RS 76 - Keycaps, illuminable	4 - 163
RS 76 - Keycap with light bar	4 - 163
RS 76 - Keycap, illuminable, with legend insert	4 - 164
RS 76 - Keycap, illuminable, with nail protection and legend insert	4 - 164
RS 76 - Keycap, illuminable, with legend insert	4 - 165
RS 76 MX - Keycap, fully illuminable	4 - 165
RS 76 - Keycaps, with legend, two-shot molded/keycap sets	4 - 166
RS 76 - Keycap set, symbols A-Z	4 - 166
RS 76 - Keycap set, symbols 0-9	4 - 167
RS 76 - Accessories	4 - 168
RS 76 - Cover IP40	4 - 168

The RAFI full-travel key switches RS 76 are modular systems for designing individual key blocks and keyboards in the 3/4 inch (= 19.05 mm) grid.

Definitions

Momentary key switches

Momentary key switches return to their initial position after being pressed (momentary action).

Latching key switches

Latching key switches lock when actuated and are returned to their initial position when pressed again (push-push action).

Keycap materials

Keycap without legend insert: ABS

Keycap with legend insert:

– Keycap body: ABS

– Lens: PC

Keycap, n-module

A 2-module keycap f. ex. has the twofold length of a 1-module keycap.

Contact principle

There are two contact principles:

– **Mechanical (M):** Cross contact (RS 76 M)
Bridge contact
(RS 76 M, illuminated)

– **Contactless (C):** Based on Hall-IC (RS 76 C)

Manual Soldering

The soldering temperature should not exceed 300 °C and the soldering time should be less than 5 seconds.

Legending of keycaps

Keycaps can be legended by different methods:

Two-shot moulding

Using this method the symbol is separately manufactured from a plastic and then the appropriate keycap form is moulded round it. Advantage: The character becomes an integrated part of the keycap, thus eliminating abrasion. All RAFI keycap sets with standard legending are manufactured by this method.

Customer specific two-shot moulded keycaps on request.

Printing

Keycaps can be printed with a two-component ink on request. The abrasion of this kind of legending is high. This method of legending is suitable for average volumes.

Engraving

In this labour intensive process the keycaps are engraved with the required symbol, then inlaid with ink. Only used for small volumes.

Laser-printing

This method of legending can be recommended when complete keyboards are required in different keyboard layouts for which RAFI will develop the respective software. The keyboards can then be legended within a short time. This method of legending is particularly recommended for average to large volumes.

Legend inserts

In the case of keycaps with replaceable legend inserts it is possible to print or engrave the legend inserts. As these inserts are protected by the lens, there can be no abrasion here either.

PCB KEY SWITCHES

RS 76 M/C - FULL-TRAVEL KEY SWITCHES

Design

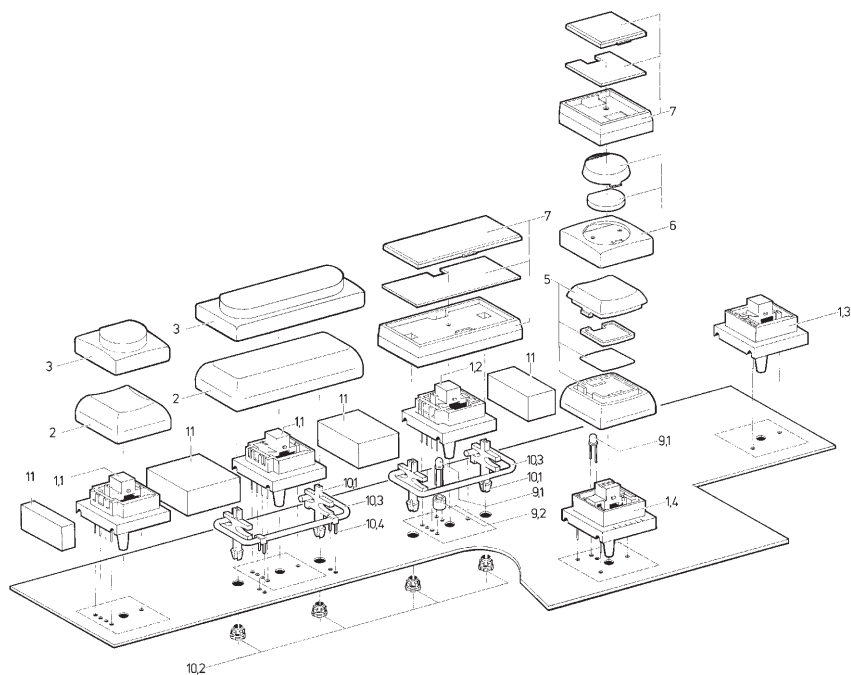

No. Description

- 1.1 Key switch RS 76 C
- 1.2 Key switch RS 76 C with LED
- 1.3 Key switch RS 76 M
- 1.4 Key switch R 76 M with LED
- 2 Keycap, 1- resp. multi-module
- 3 Keycap with nail protection, 1- resp. multi-module
- 5 Keycap, illuminated
- 6 Keycap, illuminated
- 7 Keycap, illuminated
- 9.1 LED

- 9.2 Spacer for LED (for RS 76 C only)
- 10.1 Plunger for multi-moduel keycaps*
- 10.2 Sleeve for multi-moduel keycaps*
- 10.3 Metal lever for multi-module keycaps*
- 10.4 Bearing bracket for multi-module keycaps*
- 11 Covers

* These parts are included as a complete packet in the delivery of keycaps \geq 2-module.

4

Hole pattern PCB RS 76 M/C

The hole patterns apply to the horizontal position of the keycaps only. Should they be in a vertical position,

the momentary key switch must be mounted accordingly, i. e. rotated by 90°.

For 1 – 13/4-module keycaps (view on component side)

Momentary key switch, non-illuminated

RS 76 M

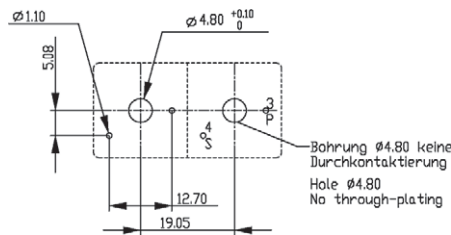

Momentary key switch, non-illuminated

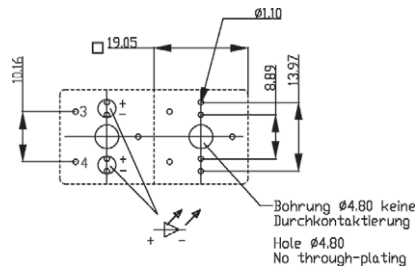

RS 76 C

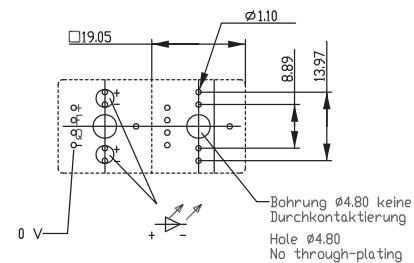
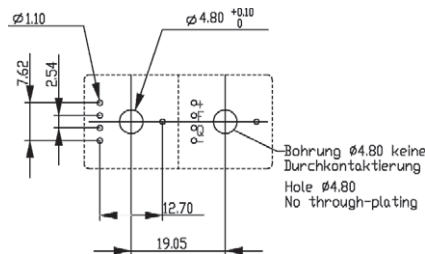

For 2-, 3- and 8-module keycaps (view on component side)

Momentary key switch, non-illuminated

RS 76 M/C

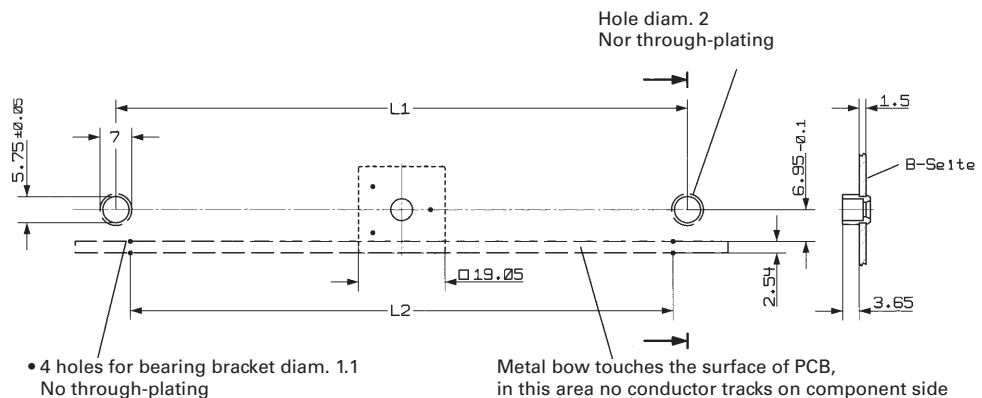

Keycap	L 1 mm	L 2 mm
2-module	25.40	22.86
3-module	30.48	24.13
5-module	68.58	68.58

Important note: In the case of 2-, 3- and 8-module keycaps, additional holes must be provided for the accessories. In the case of keycaps < 2-module, neither accessories nor holes are required.

PCB KEY SWITCHES

RS 76 M/C - FULL-TRAVEL KEY SWITCHES

Specific technical data RS 76 C

Output pulse diagram Dynamic characteristics (max.)		$T_w = 25\text{ }^\circ\text{C}$	$T_w = 50\text{ }^\circ\text{C}$	$T_w = 70\text{ }^\circ\text{C}$
Turn-on delay time	t_{PHL}	3 μs	7 μs	10 μs
Turn-off delay time	t_{PHL}	4 μs	5 μs	6 μs
Fall/rise time	t_{PHL}	2 μs	2,5 μs	3 μs
	t_{PHL}	1 μs	1,5 μs	2,5 μs

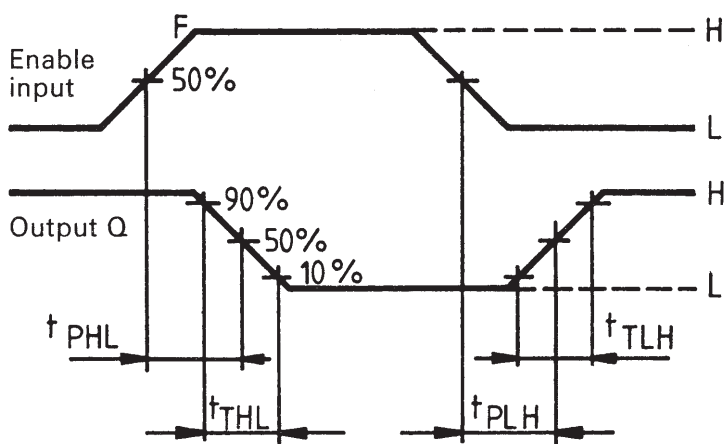

Block diagram
Hall IC

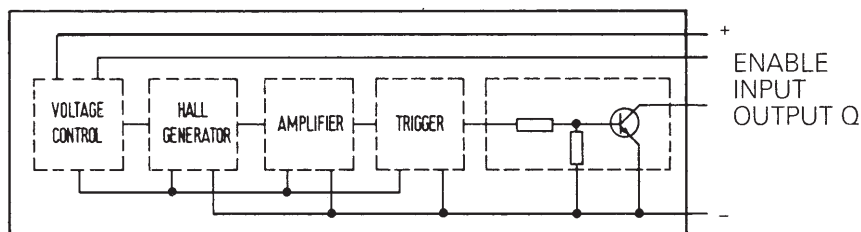

Static with Enable Input

Examples for application RS 76 C

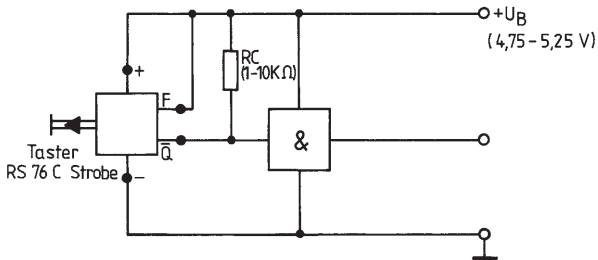

Driving of logic components

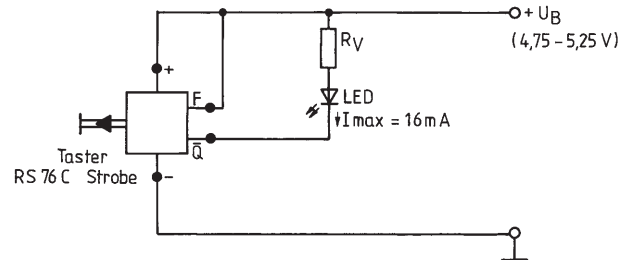

Indication of logical states

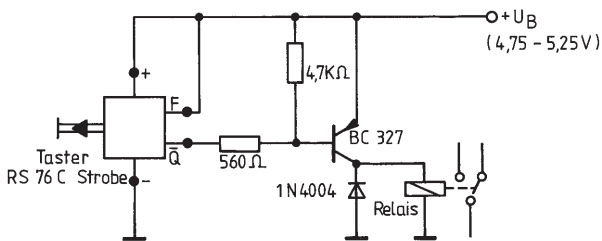

Driving of a PNP transistor

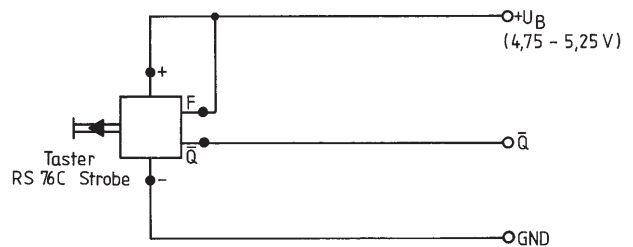

Use as static key with open collector output.
Output transistor (NPN) is conductive when actuated.

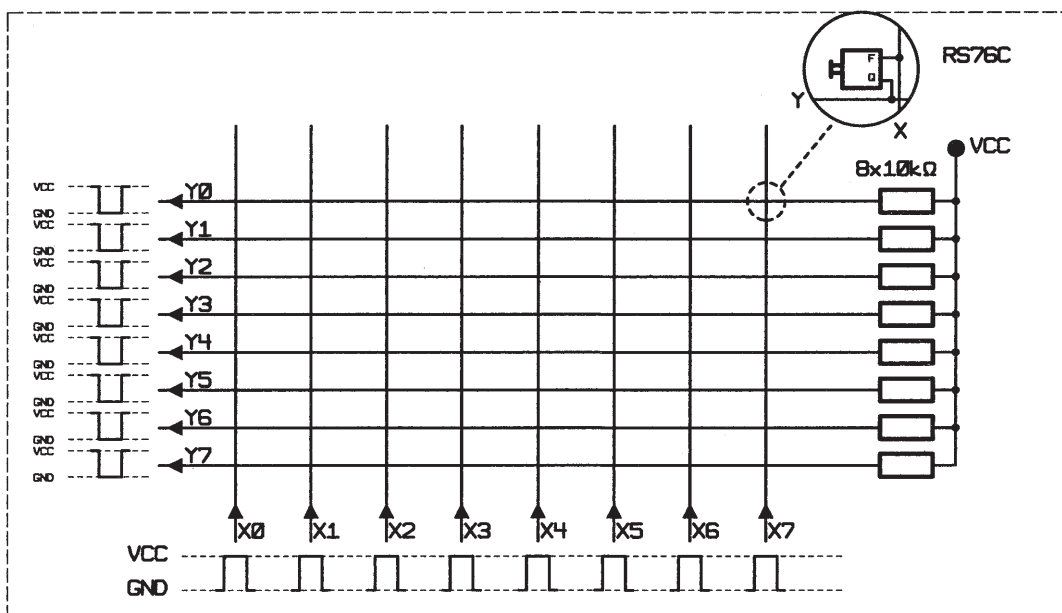

Use in keyboards

PCB KEY SWITCHES

RS 76 M - FULL-TRAVEL KEY SWITCHES, NON-ILLUMINATED

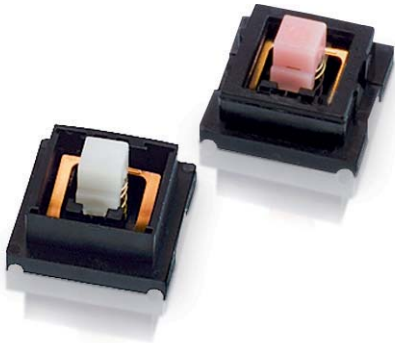

RS 76 M Full-travel key switches, not illuminable

Technical Data

→ General information	
Recommended key grid	19.05 mm
→ Mechanical design	
Contact function	momentary
Mounting	soldering
Terminals	solder terminals, tin-plated
Contact system	cross contact
Contact arrangement	1 NO
Contact materials	Au alloy
Illumination	no
→ Mechanical characteristics	
Operating force max.	see order block
Operating travel	4 mm
Switching travel	1.5 - 2.8 mm
Robustness max.	100 N
→ Electrical characteristics	
Rated voltage min.	2 V (with Diode 3 V)
Rated voltage max.	35 V
Rated current min.	0.01 mA
Rated current max.	100 mA
Rated power max.	1 W
Contact resistance when new max.	100 mΩ (ohne Diode)
Contact resistance acc. to life max.	3 Ω (without diode)
Insulation resistance	10 ⁹ Ω
ESD strength max.	8 kV
Bouncing time max.	5 ms
→ Other specifications	
Ambient temp. operating min.	-25 °C
Ambient temp. operating max.	+70 °C
Storage temperature min.	-40 °C
Storage temperature max. (product)	+80 °C
Storage temperature max. (rail)	+50 °C
Environmental resistance	acc. to IEC 60068-2-14, -30, -33 and -78
Operating life min. (operations)	10 ⁷
Degree of protection	IP40 (DIN EN 60529)
Flammability of materials	UL 94 HB
ROHS compliant	yes
REACH compliant	yes

Accessories RS 76 M - Full-travel key switch, not illuminable

→ Description	Photo	Order no.	Additional accessories see page
RS 76 C - Keycap with legend insert		-	4 - 162
RS 76 C - Keycap, opaque		-	4 - 161

PCB KEY SWITCHES

RS 76 M - FULL-TRAVEL KEY SWITCHES, NON-ILLUMINATED

– Table (continued) –
Accessories RS 76 M - Full-travel key switch, not illuminable

→ Description	Photo	Order no.	Additional accessories see page
RS 76 C - Keycap, opaque, with nail protection		-	4 - 162

RS 76 M Full-travel key switch, not illuminable



Technical data see page 4 - 150

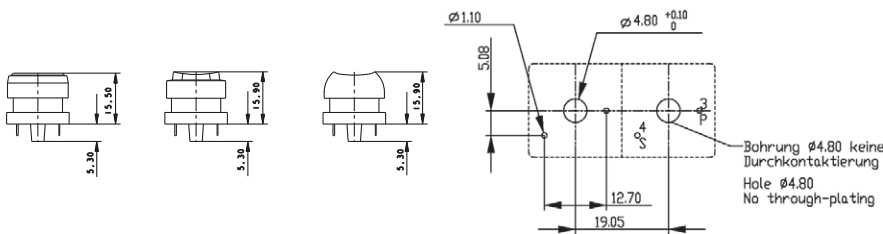

→ Contact function	Illumination	Contact arrangement	Contact materials	Operating travel	Operating force max.	Order no.
momentary	no	1 NO	Au alloy	4 mm	0.9 N	3.13.002.502/0000
momentary	no	1 NO	Au alloy	4 mm	1.4 N	3.13.002.512/0000

For accessories, refer to RS 76 special accessories.

For keycaps, see keycaps for RS 76.

PCB KEY SWITCHES

RS 76 M - FULL-TRAVEL KEY SWITCHES, NON-ILLUMINATED

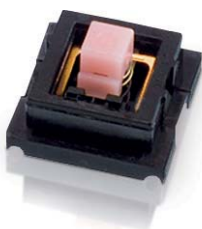

RS 76 M Full-travel key switch, with diode, not illuminable

Technical data see page 4 - 150

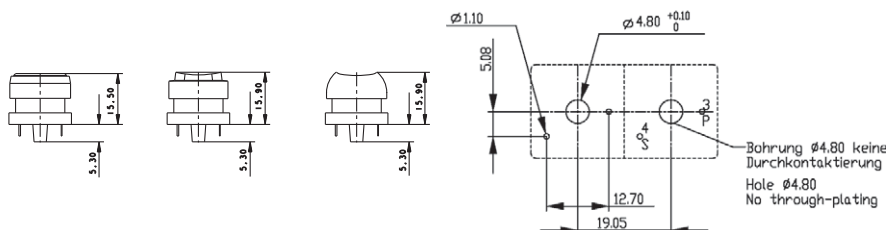

→ Contact function	Illumination	Contact arrangement	Contact materials	Operating travel	Operating force max.	Order no.
momentary	no	1 NO	Au alloy	4 mm	0.9 N	3.13.005.001/0000
momentary	no	1 NO	Au alloy	4 mm	1.4 N	3.13.005.011/0000

For accessories, refer to RS 76 special accessories.

For keycaps, see keycaps for RS 76.

RS 76 M Full-travel key switches, illuminable



RS 76MX, with illuminated keycaps

Technical Data

→ General information

Recommended key grid	19.05 mm
----------------------	----------

→ Mechanical design

Contact function	see order block
Mounting	soldering
Terminals	solder terminals, tin-plated
Contact system	bridge contact
Contact arrangement	1 NO
Contact materials	Au alloy
Illumination	see order block

→ Mechanical characteristics

Operating force max.	1 N
Operating travel	4 mm
Switching travel	1.5 - 2.8 mm
Robustness max.	100 N

→ Electrical characteristics

Rated voltage min.	2 V
Rated voltage max.	35 V
Rated current min.	0.01 mA
Rated current max.	100 mA
Rated power max.	1 W
Contact resistance when new max.	200 mΩ
Contact resistance acc. to life max.	3 Ω
Insulation resistance	10 ⁹ Ω
ESD strength max.	8 kV
Bouncing time max.	10 ms

→ Other specifications

Ambient temp. operating min.	-25 °C
Ambient temp. operating max.	+70 °C
Storage temperature min.	-40 °C
Storage temperature max. (product)	+80 °C
Storage temperature max. (rail)	+50 °C
Environmental resistance	acc. to IEC 60068-2-14, -30, -33 and -78
Operating life min. (operations)	10 ⁷ momentary, 10 ⁵ latching
Degree of protection	IP40 (DIN EN 60529)
Flammability of materials	UL 94 HB
ROHS compliant	yes
REACH compliant	yes

Accessories RS 76 M - Full-travel key switch, illuminable

→ Description	Photo	Order no.	Additional accessories see page
RS 76 - Cover IP40		-	4 - 168
RS 76 - Keycap with light bar		-	4 - 163
RS 76 - Keycap, illuminable, with legend insert		-	4 - 164

PCB KEY SWITCHES

RS 76 M - FULL-TRAVEL KEY SWITCHES, ILLUMINATED

– Table (continued) –

Accessories RS 76 M - Full-travel key switch, illuminable

→ Description	Photo	Order no.	Additional accessories see page
RS 76 - Keycap, illuminable, with nail protection and legend insert		-	4 - 164



RS 76 M Full-travel key switch, illuminable, momentary

Technical data see page 4 - 153

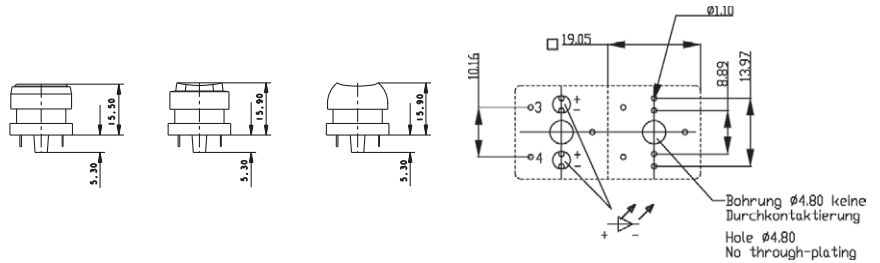

→ Contact function	Contact system	Illumination	Recommended key grid	Order no.
momentary	bridge contact	spot illumination possible with 3 LED	19.05 mm	3.13.002.102/0000

For accessories, refer to RS 76 special accessories.

For keycaps, see keycaps for RS 76.

Accessoires:

THT LED 3 mm, without base: see page 2 - 263, 5 - 8

4

RS
76

RS 76 M Full-travel key switch, illuminable, latching

Technical data see page 4 - 153

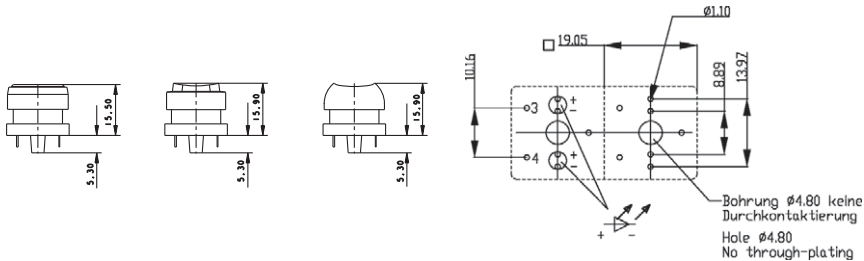

→ Contact function	Contact system	Illumination	Recommended key grid	Order no.
latching	bridge contact	spot illumination possible with 3 LED	19.05 mm	3.13.002.022/0000

For accessories, refer to RS 76 special accessories.

For keycaps, see keycaps for RS 76.

Accessoires:

THT LED 3 mm, without base: see page 2 - 263, 5 - 8

RS 76 MX Full-travel key switch, fully illuminable

Technical data see page 4 - 153

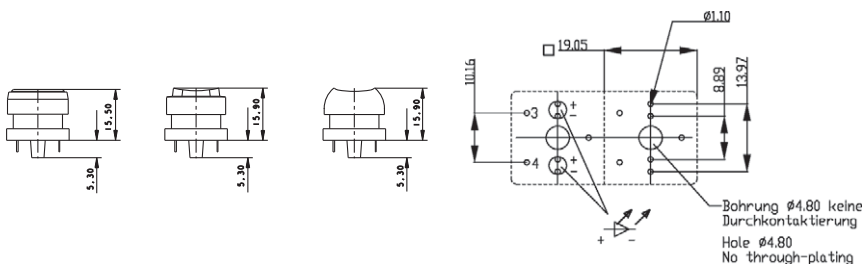

→ Contact function	Contact system	Illumination	Recommended key grid	Order no.
momentary	bridge contact	2 SMT LED needed	19.05 mm	3.13.002.922/0000

For accessories, refer to RS 76 special accessories.

For keycaps, see keycaps for RS 76.

The SMT LEDs are soldered on the back of the printed circuit board and shine through openings in the board and key switch housing.

Accessoires:

RS 76 MX - Keycap, fully illuminated: 5.05.511.168/0209

RS 76 MX - Keycap, fully illuminated: 5.05.511.168/0754

PCB KEY SWITCHES

RS 76 C - FULL-TRAVEL KEY SWITCHES, NON-ILLUMINATED



RS 76 C Full-travel key switches, not illuminable

Technical Data

→ General information

Recommended key grid	19.05 mm
----------------------	----------

→ Mechanical design

Contact function	momentary
Mounting	soldering
Terminals	solder terminals, tin-plated
Contact system	contactless with Hall-IC
Illumination	no

→ Mechanical characteristics

Switching travel off	0.8 ... 2.4 mm
Operating force max.	see order block
Operating travel	4 mm
Switching travel on	1.5 - 2.8 mm
Robustness max.	100 N

→ Electrical characteristics

Operating voltage DC	4.75 ... 5.25 V
Supply current max. at $U_{IL} = 0 V$	0.5 mA
Supply current max. at $U_{IH} = 5 V$	5 mA
Input voltage (F) at $U_{IL} = 0 V$	0.4 V
Input voltage (F) at $U_{IH} = 2.4 V$	5.25 V
Output load current (Q) max.	16 mA
Output residual current (Q) max.	10 μA
Output saturation voltage (Q) max. bei 16 mA	0.4 V
ESD strength max.	8 kV
Output switching times (Q) at 25 °C, t_{PHL}	3 μs
Output switching times (Q) at 25 °C, t_{PLH}	4 μs
Output switching times (Q) at 25 °C, t_{THL}	1 μs
Output switching times (Q) at 25 °C, t_{TLH}	2 μs

→ Other specifications

Reliability of Hall-IC at 25 °C	$\lambda = 2.5 \times 10^{-7} h^{-1}$
Ambient temp. operating min.	0 °C
Ambient temp. operating max.	+70 °C
Storage temperature min.	-40 °C
Storage temperature max. (product)	+80 °C
Storage temperature max. (rail)	+50 °C
Environmental resistance	acc. to IEC 60068-2-14, -30, -33 and -78
Operating life min. (operations)	see order block
Degree of protection	IP40 (DIN EN 60529)
Flammability of materials	UL 94 HB
ROHS compliant	yes
REACH compliant	yes

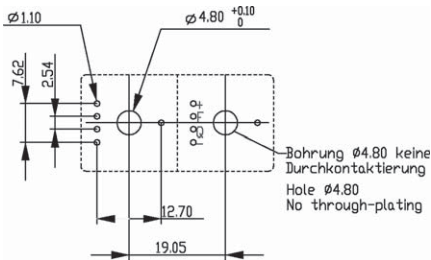
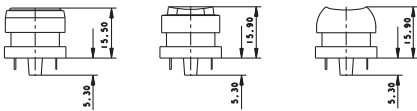



4

PCB KEY SWITCHES

RS 76 C - FULL-TRAVEL KEY SWITCHES, NON-ILLUMINATED

Accessories RS 76 C - Full-travel key switch, not illuminable

→ Description	Photo	Order no.	Additional accessories see page
RS 76 C - Keycap with legend insert		-	4 - 162
RS 76 C - Keycap, opaque		-	4 - 161
RS 76 C - Keycap, opaque, with nail protection		-	4 - 162

RS 76 C Full-travel key switch, not illuminable

Technical data see page 4 - 156

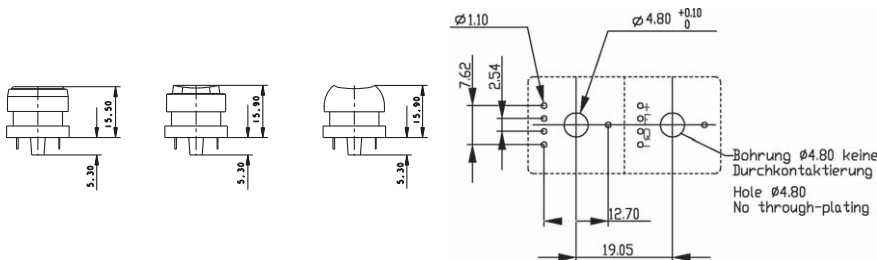

→ Contact function	Operating life min. (operations)	Illumination	Operating force max.	Operating travel	Order no.
momentary	10^8	no	0.7 N	4 mm	3.13.001.010/0000
momentary	10^8	no	1 N	4 mm	3.13.001.210/0000

For accessories and keycaps, refer to RS 76. For applications, refer to the general description of RS 76.

PCB KEY SWITCHES

RS 76 C - FULL-TRAVEL KEY SWITCHES, ILLUMINATED

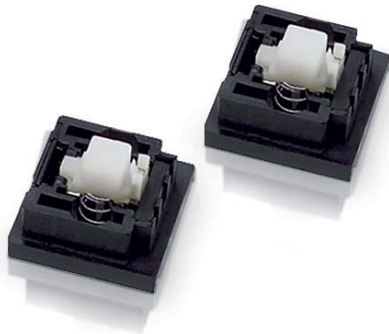

RS 76 C Full-travel key switches, illuminable

Technical Data

→ General information

Recommended key grid 19.05 mm

→ Mechanical design

Contact function see order block
Mounting soldering
Terminals solder terminals, tin-plated
Contact system contactless with Hall-IC
Illumination with LED
LED color see order block

→ Mechanical characteristics

Switching travel on 1.5 - 2.8 mm
Switching travel off 0.8 ... 2.4 mm
Operating force max. 0.7 N
Operating travel 4 mm
Robustness max. 100 N

→ Electrical characteristics

Number of LED see order block
Operating voltage DC 4.75 ... 5.25 V
Supply current max. at $U_{IL} = 0 V$ 0.5 mA
Supply current max. at $U_{IH} = 5 V$ 5 mA
Input voltage (F) at $U_{IL} = 0 V$ 0.4 V
Input voltage (F) at $U_{IH} = 2.4 V$ 5.25 V
Output load current (Q) max. 16 mA
Output residual current (Q) max. 10 μA
Output saturation voltage (Q) max. 0.4 V
bei 16 mA
ESD strength max. 8 kV
Output switching times (Q) at 25 °C, t_{PHL} 3 μs
Output switching times (Q) at 25 °C, t_{PLH} 4 μs
Output switching times (Q) at 25 °C, t_{THL} 1 μs
Output switching times (Q) at 25 °C, t_{TLH} 2 μs

→ Other specifications

Reliability of Hall-IC at 25 °C $\lambda = 2.5 \times 10^{-7} h^{-1}$
Ambient temp. operating min. 0 °C
Ambient temp. operating max. +70 °C
Storage temperature min. -40 °C
Storage temperature max. (product) +80 °C
Storage temperature max. (rail) +50 °C
Environmental resistance acc. to IEC 60068-2-14, -30, -33 and -78
Operating life min. (operations) see order block
Degree of protection IP40 (DIN EN 60529)
Flammability of materials UL 94 HB
ROHS compliant yes
REACH compliant yes

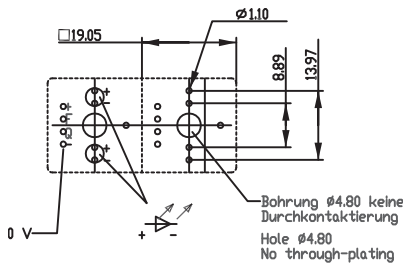
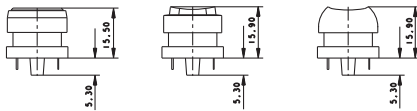

4

Accessories RS 76 C - Full-travel key switch, illuminable

→ Description

Photo

Order no.

Additional accessories see page

RS 76 - Cover IP40





-

4 - 168

PCB KEY SWITCHES

RS 76 C - FULL-TRAVEL KEY SWITCHES, ILLUMINATED

– Table (continued) –
Accessories RS 76 C - Full-travel key switch, illuminable

→ Description	Photo	Order no.	Additional accessories see page
RS 76 - Keycap with light bar		-	4 - 163
RS 76 - Keycap, illuminable, with legend insert		-	4 - 164
RS 76 - Keycap, illuminable, with nail protection and legend insert		-	4 - 164

RS 76 C Full-travel key switch, illuminable, momentary

Technical data see page 4 - 158

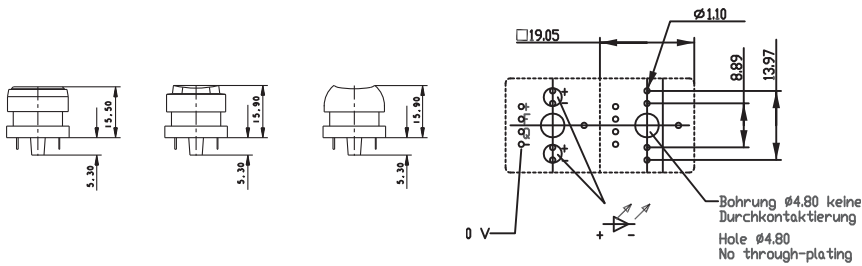

→ Contact function	Operating life min. (operations)	Illumination	Operating force max.	Operating travel	Order no.
momentary	10 ⁸	with LED	0.7 N	4 mm	3.13.001.110/0000

PCB KEY SWITCHES

RS 76 C - FULL-TRAVEL KEY SWITCHES, ILLUMINATED



RS 76 C Full-travel key switch, illuminable, latching

Technical data see page 4 - 158

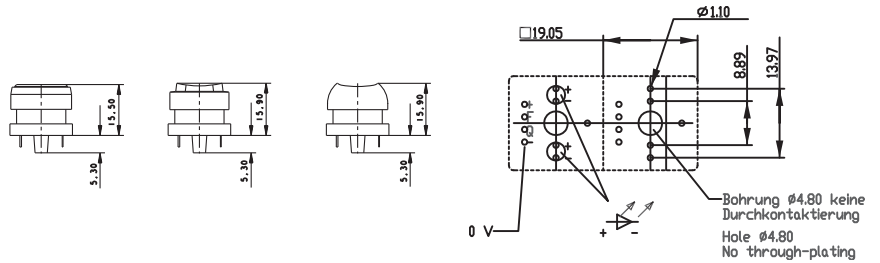

→ Contact function	Operating life min. (operations)	Illumination	Operating force max.	Operating travel	Order no.
latching	10 ⁵	with LED	0.7 N	4 mm	3.13.001.130/0000

RS 76 Keycaps, not illuminable



Technical Data

→ **General information**

Form of lens	see order block
Color of keycap / legending	see order block
Color of lens / legend insert	see order block
Illumination	see order block
Degree of protection	see order block
Size of keycap	see order block

→ **Other specifications**

ROHS compliant	yes
REACH compliant	yes

RS 76 C Keycap, opaque

Technical data see page 4 - 161



Keycap, light grey



→ Size of keycap	Illumination	Color of keycap / legending	Color of lens / legend insert	Order no.
1-module	no	charcoal grey/-	-	5.82.000.000/0152
1-module	no	light grey/-	-	5.82.000.000/0242

Keycap sets available in two-shot molded design.

Other keycap sizes, e.g. 1.25-, 1.5-, 1.75-, 2-, 3-, 5- and 8-module versions available on request.

PCB KEY SWITCHES

RS 76 - KEYCAPS, NON-ILLUMINATED

RS 76 C Keycap, opaque, with nail protection



Technical data see page 4 - 161

opaque with nail protection charcoal grey / white

→ Size of keycap	Illumination	Color of keycap / legending	Color of lens / legend insert	Order no.
1-module	no	charcoal grey/-	-	5.80.000.000/0152
1-module	no	light grey/-	-	5.80.000.000/0242

Keycap sets available in two-shot molded design.

Other keycap sizes, e.g. 1.25-, 1.5-, 1.75-, 2-, 3- and 8-module versions available on request.

RS 76 C Keycap with legend insert



Technical data see page 4 - 161

→ Size of keycap	Illumination	Color of keycap / legending	Color of lens / legend insert	Order no.
1-module	no	charcoal grey/-	colorless/white	5.04.665.221/5520
1-module	no	light grey/-	colorless/white	5.04.665.230/5520

Supplied as single parts: Mat lens, legend insert, keycap body.

Other colors on request.

4

RS
76

RS 76 Keycaps, illuminable

Technical Data

→ **General information**

Form of lens	see order block
Color of keycap / legending	see order block
Color of lens / legend insert	see order block
Illumination	see order block
Degree of protection	see order block
Size of keycap	see order block

→ **Other specifications**

ROHS compliant	yes
REACH compliant	yes



RS 76 Keycap with light bar

Technical data see page 4 - 163



→ Size of keycap	Illumination	Color of keycap / legending	Color of lens / legend insert	Order no.
1-module	yes	light grey/-	-	5.82.110.000/0242
1-module	yes	charcoal grey/-	-	5.82.110.000/0152

Other colors on request.

PCB KEY SWITCHES

RS 76 - KEYCAPS, ILLUMINATED



RS 76 Keycap, illuminable, with legend insert

Technical data see page 4 - 163

→ Size of keycap	Illumination	Color of keycap / legending	Color of lens / legend insert	Order no.
1-module	yes	charcoal grey/-	colorless/white	5.04.665.521/5520
1-module	yes	light grey/-	colorless/white	5.04.665.530/5520

Supplied as single parts: Mat lens, legend insert, diffuser foil, keycap body.
Other colors on request.



RS 76 Keycap, illuminable, with nail protection and legend insert

Technical data see page 4 - 163

→ Size of keycap	Illumination	Color of keycap / legending	Color of lens / legend insert	Order no.
1-module	yes	charcoal grey/-	colorless/white	5.04.665.911/5520
1-module	yes	light grey/-	colorless/white	5.04.665.920/5520

Supplied as single parts: Mat lens, legend insert, keycap body.
Other colors on request.

4

RS
76

RS 76 Keycap, illuminable, with legend insert

Technical data see page 4 - 163



→ Size of keycap	Illumination	Color of keycap / legending	Color of lens / legend insert	Order no.
1-module	yes	charcoal grey/-	colorless/white	5.04.665.161/5520
1-module	yes	light grey/-	colorless/white	5.04.665.170/5520

Supplied as single parts: Mat lens, legend insert, diffuser foil, keycap body.
Other colors on request.

RS 76 MX Keycap, fully illuminable

Technical data see page 4 - 163



RS 76MX, with illuminated keycaps

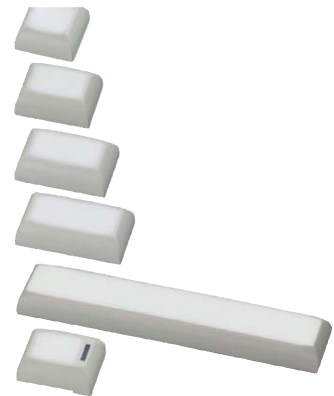

→ Size of keycap	Illumination	Color of keycap / legending	Color of lens / legend insert	Order no.
1-module	yes	white/-	white translucent/-	5.05.511.168/0209
1-module	yes	light grey/-	white translucent/-	5.05.511.168/0754
1¼-module	yes	white/-	white translucent/-	5.05.511.169/0209
1½-module	yes	white/-	white translucent/-	5.05.511.170/0209
1¾-module	yes	white/-	white translucent/-	5.05.511.171/0209
1¼-module with light conductor	yes	white/-	white translucent/-	5.05.511.173/0209

Laser-printed versions available on request.

PCB KEY SWITCHES

RS 76 - KEYCAPS, WITH LEGEND, TWO-SHOT MOLDED/KEYCAP SETS



RS 76 Keycaps, with legend, two-shot molded/ keycap sets



Mouse button, 2 x PS/2 connector

Technical Data

→ General information

Form of lens	see order block
Color of keycap / legending	see order block
Symbol	see order block
Illumination	see order block
Degree of protection	see order block
Size of keycap	see order block

→ Other specifications

ROHS compliant	yes
REACH compliant	yes

4



RS 76 Keycap set, symbols A-Z

Technical data see page 4 - 166

A	B	C	D	E	F	G	H	I	J	K	L	M
N	O	P	Q	R	S	T	U	V	W	X	Y	Z



light beige

→ Size of keycap	Form of lens	Color of keycap / legending	Symbol	Order no.
1-module	keycap opaque with nail protection	charcoal grey/white	A-Z	5.00.999.500/0000
1-module	keycap opaque with nail protection	light grey/black	A-Z	5.00.999.824/0000
1-module	keycap opaque	charcoal grey/white	A-Z	5.00.999.525/0000
1-module	keycap opaque	light grey/black	A-Z	5.00.999.825/0000

Other symbols and colors on request.

RS
76

PCB KEY SWITCHES

RS 76 - KEYCAPS, WITH LEGEND, TWO-SHOT MOLDED/KEYCAP SETS

RS 76 Keycap set, symbols 0-9

Technical data see page 4 - 166

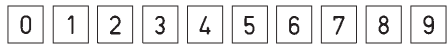

opaque with nail protection charcoal grey / white

→ Size of keycap	Form of lens	Color of keycap / legending	Symbol	Order no.
1-module	keycap opaque with nail protection	charcoal grey/white	0-9	5.00.999.504/0000
1-module	keycap opaque with nail protection	light grey/black	0-9	5.00.999.826/0000
1-module	keycap opaque	charcoal grey/white	0-9	5.00.999.529/0000
1-module	keycap opaque	light grey/black	0-9	5.00.999.827/0000

Other symbols and colors on request.

PCB KEY SWITCHES

RS 76 - SPECIAL ACCESSORIES



RS 76 Accessories

Technical Data

→ **General information**

Color	see order block
Size	see order block

→ **Other specifications**

ROHS compliant	yes
REACH compliant	yes

RS 76 Cover IP40

Technical data see page 4 - 168

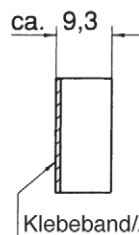
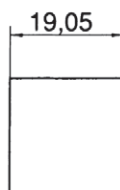

Klebeband/Adhesive Tape

4

→ Color	Size	Order no.
charcoal grey	¼-module	5.04.520.171/0152
light grey	¼-module	5.04.520.171/0242
light beige	¼-module	5.04.520.171/0710
dark grey	¼-module	5.04.520.171/0801
charcoal grey	½-module	5.04.520.172/0152
light grey	½-module	5.04.520.172/0242
light beige	½-module	5.04.520.172/0710
dark grey	½-module	5.04.520.172/0801
charcoal grey	¾-module	5.04.520.173/0152
light grey	¾-module	5.04.520.173/0242
light beige	¾-module	5.04.520.173/0710
dark grey	¾-module	5.04.520.173/0801
charcoal grey	1-module	5.04.520.174/0152

RS
76

PCB KEY SWITCHES

RS 76 - SPECIAL ACCESSORIES

– Table (continued) –
RS 76 - Cover IP40

→ Color	Size	Order no.
light grey	1-module	5.04.520.174/0242
light beige	1-module	5.04.520.174/0710
dark grey	1-module	5.04.520.174/0801

Other colors on request.



Keylock / rotary switches

for PCB

Keylock switches for PCB mounting. Matching with the RS 76 full-travel key switches and the RF 15 and RF 19 tactile switches.

- All products are RoHS compliant.

PCB KEY SWITCHES

MICROMECC - KEYLOCK SWITCHES

Content

MICROMECC - Keylock switches, IP54

4 - 173

MICROMECC - Keylock switch IP54

4 - 176

EUROLOCKS - Keylock switches, IP54

4 - 177

EUROLOCKS - Keylock switch IP54

4 - 178

Priority keylock switches, IP54

4 - 179

Priority keylock switch IP54

4 - 180

Rotary switches, IP40

4 - 181

Rotary switch IP40

4 - 182

MICROMECC Keylock switches, IP54

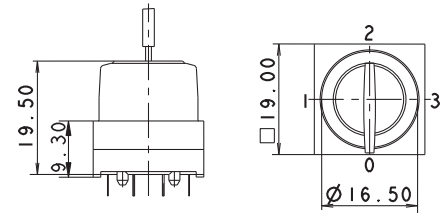

Technical Data

→ General information	
Color	see order block
Form of collar	square
→ Dimensions	
Length of collar	19 mm
Width of collar	19 mm
Overall height	19.5 mm
→ Mechanical design	
Mounting	soldering
Terminals	tin-plated
Contact system	cross contact self cleaning
Contact function	see order block
Contact materials	Au alloy
Illuminability	no
Lock	Micromec
Wafers	5
Lock type	001
Number of locking positions	500
Main key	on request
Key removal position	see order block
→ Mechanical characteristics	
Switching torque	0.04 ... 0.10 Nm
Robustness max.	2 Nm
Dielectric strength AC min.	500 V
Rated power max.	1 W
→ Electrical characteristics	
Rated voltage	2 ... 35 V
Rated current max.	100 mA
Contact resistance when new max.	100 mΩ
Contact resistance acc. to life max.	200 mΩ
Insulation resistance	10 ⁹ Ω
ESD strength max.	8 kV
→ Other specifications	
Rotating angle	see order block
Operating life	10,000
Degree of protection from front side	IP54
Ambient temp. operating min.	-25 °C
Ambient temp. operating max.	+70 °C
Storage temperature min.	-40 °C
Storage temperature max.	+80 °C
Environmental resistance	acc. to IEC 60068-2-14, -30, -33 and -78
Flammability of materials	UL 94 HB
ROHS compliant	yes
REACH compliant	yes





Accessories MICROMECC - Keylock switch IP54

→ Description	Photo	Order no.	Additional accessories see page
O-ring for keylock switch		5.30.120.015/0100	5 - 31

PCB KEY SWITCHES

MICROMECC - KEYLOCK SWITCHES IP 54

– Table (continued) –
Accessories MICROMECC - Keylock switch IP54

→ Description	Photo	Order no.	Additional accessories see page
Spare key, (delivery content 1 key)		5.58.007.001/0000	-
Spare key, for double action, e.g. 2 x 90° (delivery content 1 key)		5.58.008.001/0000	-
Spare key for 3 angles, f.ex. 3 x 90° degree (content 1 key)		5.58.009.001/0100	-
Spare key for 4 angles, f.ex. 4 x 90 degrees, (content 1 key)		5.58.010.001/0100	-

PCB KEY SWITCHES

MICROMECC - KEYLOCK SWITCHES IP 54

Dimensional drawing



Circuit diagram

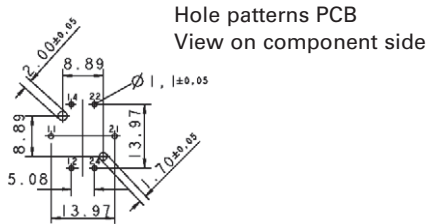

Switching position	Contact function
0	
1	
2	
3	

PCB KEY SWITCHES

MICROMECC - KEYLOCK SWITCHES IP 54



MICROMECC Keylock switch IP54

Technical data see page 4 - 173

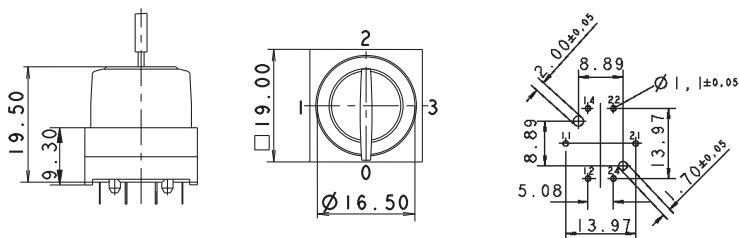

PCB hole pattern, component side

→ Contact function	Color	Rotating angle	Key removal position	Order no.
momentary	charcoal grey	1 x 40°	0	3.13.026.041/0000
momentary	light grey	1 x 40°	0	3.13.026.541/0000
latching	charcoal grey	1 x 90°	0	3.13.026.001/0000
latching	light grey	1 x 90°	0	3.13.026.501/0000
latching	charcoal grey	1 x 90°	0+1	3.13.026.006/0000
latching	light grey	1 x 90°	0+1	3.13.026.506/0000
latching	charcoal grey	3 x 90°	0	3.13.026.021/0000
latching	light grey	3 x 90°	0	3.13.026.521/0000
latching	charcoal grey	3 x 90°	0+1+2+3	3.13.026.026/0000
latching	light grey	3 x 90°	0+1+2+3	3.13.026.526/0000
latching	charcoal grey	4 x 90° without stop	0	3.13.026.031/0000
latching	light grey	4 x 90° without stop	0	3.13.026.531/0000
latching	charcoal grey	4 x 90° without stop	0+1+2+3	3.13.026.036/0000
latching	light grey	4 x 90° without stop	0+1+2+3	3.13.026.536/0000
latching	charcoal grey	2 x 90°	0	3.13.026.011/0000
latching	light grey	2 x 90°	0	3.13.026.511/0000
latching	charcoal grey	2 x 90°	0+1+2	3.13.026.016/0000
latching	light grey	2 x 90°	0+1+2	3.13.026.516/0000
latching	charcoal grey	2 x 90°	0	3.13.026.601/0000
latching	light grey	2 x 90°	0	3.13.026.851/0000
latching	charcoal grey	2 x 90°	0+1+3	3.13.026.606/0000
latching	light grey	2 x 90°	0+1+3	3.13.026.856/0000

2 keys included.

Other lock variants available on request.

EUROLOCKS

Keylock switches, IP54

Technical Data

→ General information

Color	see order block
Form of collar	square

→ Dimensions

Length of collar	19 mm
Width of collar	19 mm
Overall height	19.5 mm

→ Mechanical design

Mounting	soldering
Terminals	tin-plated
Contact system	cross contact self cleaning
Contact function	latching
Contact materials	Au alloy
Illuminability	no
Lock	Eurolocks
Wafers	5
Lock type	801
Number of locking positions	50
Main key	no
Symmetric key	yes
Key removal position	see order block

→ Mechanical characteristics

Switching torque	0.04 ... 0.10 Nm
Robustness max.	2 Nm
Dielectric strength AC min.	500 V
Rated power max.	1 W

→ Electrical characteristics

Rated voltage	2 ... 35 V
Rated current max.	100 mA
Contact resistance when new max.	100 mΩ
Contact resistance acc. to life max.	200 mΩ
Insulation resistance	10 ⁹ Ω
ESD strength max.	8 kV

→ Other specifications

Rotating angle	see order block
Operating life	10,000
Degree of protection from front side	IP54
Ambient temp. operating min.	-25 °C
Ambient temp. operating max.	+70 °C
Storage temperature min.	-40 °C
Storage temperature max.	+80 °C
Environmental resistance	acc. to IEC 60068-2-14, -30, -33 and -78
Flammability of materials	UL 94 HB
ROHS compliant	yes
REACH compliant	yes

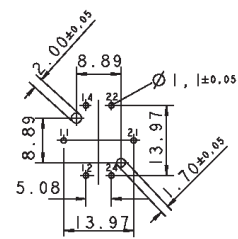
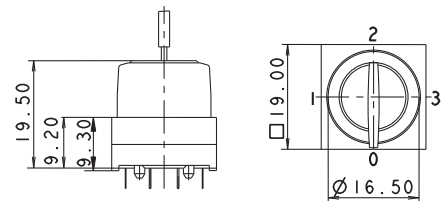

PCB hole pattern, component side

Accessories EUROLOCKS - Keylock switch IP54

→ Description	Photo	Order no.	Additional accessories see page
O-ring for keylock switch		5.30.120.015/0100	5 - 31

PCB KEY SWITCHES

EUROLOCKS - KEYLOCK SWITCHES IP 54

– Table (continued) –
Accessories EUROLOCKS - Keylock switch IP54

→ Description	Photo	Order no.	Additional accessories see page
Spare key (delivery content 1 key)		5.58.006.801/0000	-



EUROLOCKS Keylock switch IP54

Technical data see page 4 - 177

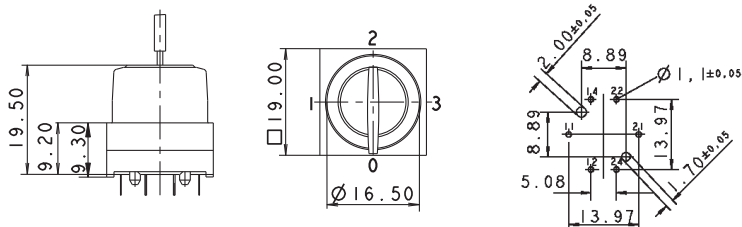

PCB hole pattern, component side

→ Contact function	Color	Rotating angle	Key removal position	Order no.
latching	charcoal grey	1 x 90°	0	3.13.009.001/0000
latching	light grey	1 x 90°	0	3.13.009.006/0000
latching	charcoal grey	1 x 90°	0+1	3.13.009.031/0000
latching	light grey	1 x 90°	0+1	3.13.009.036/0000

4

2 keys included.

Other lock variants available on request.

For the switching arrangement, refer to Micromec keylock switch IP54.

PRIORITY KEYLOCK SWITCHES, IP54

→ Either 2 or 3 different keys are required, depending on the angle between positions. Key 1 can switch to position 1, key 2 can switch to position 1 and 2, etc.



Technical Data

→ General information

Color	see order block
Form of collar	square

→ Dimensions

Length of collar	19 mm
Width of collar	19 mm
Overall height	19.5 mm

→ Mechanical design

Mounting	soldering
Terminals	tin-plated
Contact system	cross contact self cleaning
Contact function	see order block
Contact materials	Au alloy
Illuminability	no
Lock	Micromec
Wafers	5
Lock type	001
Number of locking positions	500
Main key	on request
Key removal position	see order block

→ Mechanical characteristics

Switching torque	0.04 ... 0.10 Nm
Robustness max.	2 Nm
Dielectric strength AC min.	500 V
Rated power max.	1 W

→ Electrical characteristics

Rated voltage	2 ... 35 V
Rated current max.	100 mA
Contact resistance when new max.	100 mΩ
Contact resistance acc. to life max.	200 mΩ
Insulation resistance	10 ⁹ Ω
ESD strength max.	8 kV

→ Other specifications

Rotating angle	see order block
Operating life	10,000
Degree of protection from front side	IP54
Ambient temp. operating min.	-25 °C
Ambient temp. operating max.	+70 °C
Storage temperature min.	-40 °C
Storage temperature max.	+80 °C
Environmental resistance	acc. to IEC 60068-2-14, -30, -33 and -78
Flammability of materials	UL 94 HB
ROHS compliant	yes
REACH compliant	yes

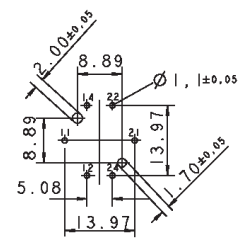
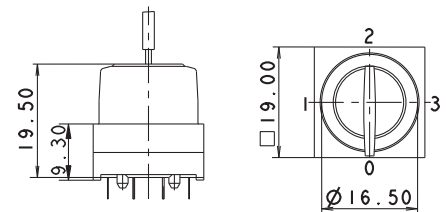



PCB hole pattern, component side

PCB KEY SWITCHES

PRIORITY KEYLOCK SWITCHES IP 54

Accessories Priority keylock switch IP54

→ Description	Photo	Order no.	Additional accessories see page
O-ring for keylock switch		5.30.120.015/0100	5 - 31
Set of keys for 2 x 90° type (2 keys)		5.58.099.012/0000	-
Set of keys for 3 x 90° type (3 keys)		5.58.099.013/0000	-



Priority keylock switch IP54

Technical data see page 4 - 179

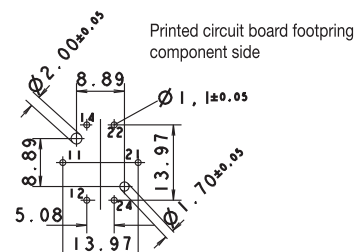
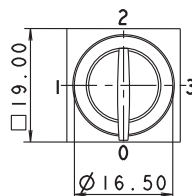
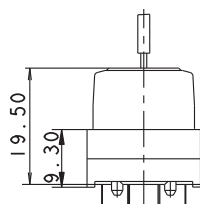

PCB hole pattern, component side

→ Contact function	Color	Rotating angle	Key removal position	Order no.
latching	charcoal grey	3 x 90°	0	3.13.027.011/0000
latching	light grey	3 x 90°	0	3.13.027.511/0000
latching	charcoal grey	3 x 90°	0+1+2+3	3.13.027.016/0000
latching	light grey	3 x 90°	0+1+2+3	3.13.027.516/0000
latching	charcoal grey	2 x 90°	0	3.13.027.001/0000
latching	light grey	2 x 90°	0	3.13.027.501/0000
latching	charcoal grey	2 x 90°	0+1+2	3.13.027.006/0000
latching	light grey	2 x 90°	0+1+2	3.13.027.506/0000

2 sets of keys included.

Other lock variants available on request.

For the switching arrangement, see IP54 Micromec keylock switch.

Either 2 or 3 different keys are required, depending on the angle between positions. Key 1 can switch to position 1, key 2 can switch to position 1 and 2, etc.

ROTARY SWITCHES, IP40

Technical Data

→ General information

Color	see order block
Form of collar	square

→ Dimensions

Length of collar	19 mm
Width of collar	19 mm
Overall height	24 mm

→ Mechanical design

Mounting	soldering
Terminals	tin-plated
Contact system	cross contact self cleaning
Contact function	see order block
Contact materials	Au alloy
Illuminability	no

→ Mechanical characteristics

Torque against stop min.	0.45 Nm
Dielectric strength AC min.	see order block
Rated power max.	1 W

→ Electrical characteristics

Rated voltage max.	35 V
Rated current max.	100 mA
Contact resistance when new max.	100 mΩ
Contact resistance acc. to life max.	200 mΩ
Insulation resistance	10 ⁹ Ω
ESD strength max.	8 kV

→ Other specifications

Rotating angle	see order block
Operating life	50,000
Degree of protection from front side	IP40 (DIN EN 60529)
Ambient temp. operating min.	-25 °C
Ambient temp. operating max.	+70 °C
Storage temperature min.	-40 °C
Storage temperature max.	+80 °C
Environmental resistance	acc. to IEC 60068-2-14, -30, -33 and -78
Flammability of materials	UL 94 HB
ROHS compliant	yes
REACH compliant	yes

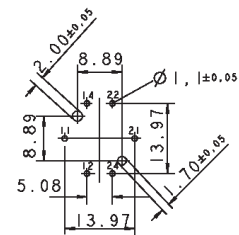
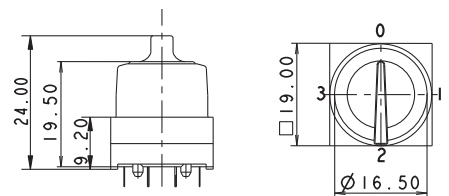

PCB hole pattern, component side

PCB KEY SWITCHES

ROTARY SWITCHES IP40



Rotary switch IP40

Technical data see page 4 - 181

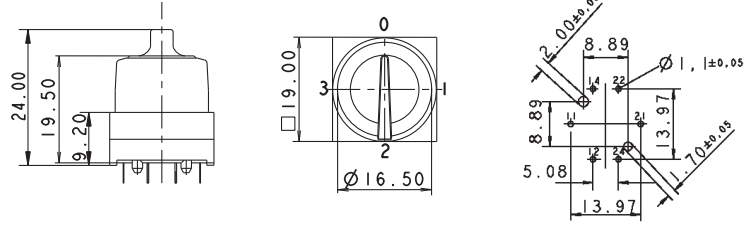

PCB hole pattern, component side

→ Contact function	Color	Rotating angle	Order no.
latching	charcoal grey	1 x 90°	3.13.007.001/0152
latching	charcoal grey	3 x 90°	3.13.007.021/0152
latching	charcoal grey	4 x 90°	3.13.007.031/0152
latching	charcoal grey	2 x 90°	3.13.007.011/0152

Other color variants available on request

5

ACCESSORIES

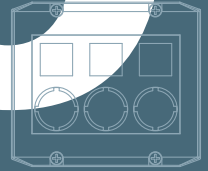

Accessories Luminous elements

LED

Filament/neon lamps

5 - 3

5 - 5

5 - 9

Other accessories

Housing

Emergency stop labels

Blanking caps

Tools

Connection

Protection & Sealing

Spacers

5 - 17

5 - 19

5 - 21

5 - 22

5 - 25

5 - 28

5 - 30

5 - 32

LUMINOUS ELEMENTS

GENERAL INFORMATION / CE-CONFORMITY

General information

When selecting lamps, the button/lens color of the device should be taken into account.

transparent colors	Suitable for		
	Filament lamps	Neon lamps	LED
colorless	limited	good	good
red	good	good	good
yellow	good	good	good
green	good	limited	limited
blue	limited	limited	good

transparent = clear, grooved on inside for better light diffusion

translucent = translucent but not clear

Operating life specifications of lamps refer to AC operation. For DC operation, these values are reduced by approximately 40%. (Operating life specifications: when not mounted).

Neon lamps: rated current tolerance +/- 30%

We recommend to combine colored lenses with the corresponding LED colors in order to achieve a really intensive color.

On the other hand, when combining e. g. a white LED with a colored lens, this will produce a dim color.

LED Protective Diode

LED may be damaged when anode and cathode are connected in a wrong way. An integrated protective diode protects the LED against wrong polarization.

LED brightness classes

LEDs are subject to production-related variations in brightness over which we have no control with the manufacturers. It is therefore not possible to arrange a delivery in a specific brightness class, and deviations accordingly do not constitute grounds for complaint regarding our products.

The majority of the LEDs we use are delivered from our suppliers in selected brightness classes. In this case, the brightness class is shown on a label on the switch's rack packaging.

Where the lighting is required to have a uniform brightness – for aesthetic reasons, for example – this can be achieved in the system by means of the circuitry (with a series resistance, for example).

CE-Conformity

Illumination like lamps and LED displays are exchangeable, overall available as merchandise and not steadily connected with the network – thus, the Low-voltage Directive 73/23/EWG does not apply.

EMC

The components of this catalogue are within the meaning of the law concerning the electromagnetic conformity (= EMC) "basic components as f. ex. switches, signal lamps or like" and, therefore, do not all within the scope of the EMC.

Declarations of Conformity

Declarations of conformity for lamps are not available.



Accessories

Luminous elements

Luminous elements

ACCESSORIES

ACCESSORIES - LUMINOUS ELEMENTS

Content

LED

Socket W 2 x 4.6d, LED superbright	5 - 5
Socket Bi-Pin T 1, LED	5 - 6
Socket Bi-Pin T 1, LED superbright	5 - 6
Socket T 4.5, LED	5 - 7
Socket T 4.5, LED superbright	5 - 7
Socket BA 9s (MBC/MCC), LED superbright	5 - 8
THT LED 3 mm, without base	5 - 8

Filament/ neon lamps

Wedge base W 2 x 4.6d, filament lamp, DIN 49846	5 - 9
Bi-Pin T 1 base, filament lamp	5 - 10
Bi-Pin T ¼ base, filament lamp	5 - 10
T 4.5 base, filament lamp	5 - 10
T 4.6 base, filament lamp	5 - 11
BA 9s base (MBC/MCC), filament lamp, shape G, DIN 72601	5 - 11
BA 9s base (MBC/MCC), filament lamp, shape A, DIN 49851	5 - 11
BA 9s base (MBC/MCC), neon lamp	5 - 12
BA 9s base (MBC/MCC), neon lamp, DIN 49850	5 - 12
BA 15d base, filament lamp, DIN 49850	5 - 12
BA 15d base, filament lamp, DIN 49852	5 - 13
BA 15d base, filament lamp	5 - 13
E 10 (MES) base, filament lamp	5 - 13
E 10 (MES) base, neon lamp	5 - 14
E 14 base, shape B, filament lamp, DIN 49850	5 - 14
E 14 base, filament lamp shape A, DIN 49852	5 - 14
E 14 base, filament lamp	5 - 15
E 14 base, neon lamp, shape B	5 - 15
Tubular lamp, S 8.5 base, filament lamp, shape L, DIN 72601	5 - 15
Tubular lamp, S 8.5 base, filament lamp, shape K, DIN 72601	5 - 16

LED



Socket W 2 x 4.6d, LED superbright



→ Socket	Color	Forward voltage typ. U_F at I_F	Max. current, I_F	Light intensity	Order no.
W 2 x 4.6d	red	24	12 mA	70 mcd	1.90.690.361/0000
W 2 x 4.6d	yellow	24	12 mA	80 mcd	1.90.690.363/0000
W 2 x 4.6d	green	24	12 mA	600 mcd	1.90.690.362/0000
W 2 x 4.6d	blue	24	12 mA	300 mcd	1.90.690.364/0000
W 2 x 4.6d	white	24	12 mA	400 mcd	1.90.690.365/0000

All LEDs are provided with a protective diode. Operating temperature - 30 °C ... + 65 °C.

For more intensive colors, please combine colored lenses with suitable LED colors.

Accessoires:

Lamp extractor for lamp diameter 5 mm: 1.90.900.003/0000

ACCESSORIES

LED



Socket Bi-Pin T 1, LED

→ Socket	Color	Forward voltage typ. U_F at I_F	Max. current, I_F	Light intensity	Order no.
Bi-Pin T 1	red	2	10 mA	26-52 mcd	1.90.691.026/0000
Bi-Pin T 1	yellow	2	10 mA	26-52 mcd	1.90.691.028/0000
Bi-Pin T 1	green	2	10 mA	9-33 mcd	1.90.691.027/0000

Voltage U_B : External resistor: $R_V = (U_B - U_F) / I_F$

A suitable series resistor must be fitted externally.

Recommended resistor ratings:

- for 5 - 7 V = 270 Ω 0.25 W

- for 12 - 14 V = 680 Ω 0.50 W

- for 24 - 28 V = 1500 Ω 1.00 W

Forward voltage U_F : 2 V (3 V max.)

Reverse voltage U_R : 5 V

Reverse current I_R : 100 μ A.

Forward current: 10 mA

Operating temperature: -20°C ... +60°C

Storage temperature: -30°C ... +80°C

Operating life: 100,000 h at $T_U = 25^\circ\text{C}$

Accessoires:

Lamp extractor for lamp diameter 4 mm: 1.90.900.001/0000



Socket Bi-Pin T 1, LED superbright

→ Socket	Color	Forward voltage typ. U_F at I_F	Max. current, I_F	Light intensity	Order no.
Bi-Pin T 1	red	24	11 mA	70 mcd	1.90.690.351/0000
Bi-Pin T 1	yellow	24	11 mA	80 mcd	1.90.690.353/0000
Bi-Pin T 1	green	24	11 mA	600 mcd	1.90.690.352/0000
Bi-Pin T 1	blue	24	11 mA	300 mcd	1.90.690.354/0000
Bi-Pin T 1	white	24	11 mA	400 mcd	1.90.690.355/0000

All LEDs are provided with a protective diode. Operating temperature - 30 °C ... + 65 °C.

For more intensive colors, please combine colored lenses with suitable LED colors.

Accessoires:

Lamp extractor for lamp diameter 4 mm: 1.90.900.001/0000

5

Lamps

Socket T 4.5, LED



→ Socket	Color	Forward voltage typ. U_F at I_F	Max. current, I_F	Light intensity	Order no.
T 4.5	red	2 - 3 V	10 mA	26-52 mcd	1.90.692.001/0000
T 4.5	yellow	2 - 3 V	10 mA	26-52 mcd	1.90.692.003/0000
T 4.5	green	2 - 3 V	10 mA	9-33 mcd	1.90.692.002/0000

Voltage U_B : External resistor: $R_V = (U_B - U_F) : I_F$

A suitable series resistor must be fitted externally.

Recommended resistor ratings:

- for 5 - 7 V = 270 Ω 0.25 W

- for 12 - 14 V = 680 Ω 0.50 W

- for 24 - 28 V = 1500 Ω 1.00 W

Forward voltage U_F : 2 V (3 V max.)

Reverse voltage U_R : 5 V

Reverse current I_R : 100 μ A.

Forward current: 10 mA

Operating temperature: -20°C ... +60°C

Storage temperature: -30°C ... +80°C

Operating life: 100,000 h at $T_U = 25^\circ\text{C}$

Socket T 4.5, LED superbright



→ Socket	Color	Forward voltage typ. U_F at I_F	Max. current, I_F	Light intensity	Order no.
T 4.5	red	24	13 mA	90 mcd	1.90.690.331/0000
T 4.5	yellow	24	13 mA	100 mcd	1.90.690.333/0000
T 4.5	green	24	13 mA	700 mcd	1.90.690.332/0000
T 4.5	blue	24	13 mA	380 mcd	1.90.690.334/0000
T 4.5	white	24	13 mA	500 mcd	1.90.690.335/0000

All LEDs are provided with a protective diode. Operating temperature - 30 °C ... + 65 °C.

For more intensive colors, please combine colored lenses with suitable LED colors.

Accessoires:

Lamp extractor for lamp diameter 5-6 mm: 1.90.900.004/0000

ACCESSORIES

LED



Socket BA 9s (MBC/MCC), LED superbright

→ Socket	Color	Forward voltage typ. U_F at I_F	Max. current, I_F	Light intensity	Order no.
BA 9 s	red	24	15 mA	250 mcd	1.90.690.341/0000
BA 9 s	yellow	24	15 mA	250 mcd	1.90.690.343/0000
BA 9 s	green	24	15 mA	1000 mcd	1.90.690.342/0000
BA 9 s	blue	24	15 mA	450 mcd	1.90.690.344/0000
BA 9 s	white	24	15 mA	600 mcd	1.90.690.345/0000

All LEDs are provided with a protective diode. Operating temperature - 30 °C ... + 65 °C.

For more intensive colors, please combine colored lenses with suitable LED colors.

Accessoires:

Lamp extractor for lamp diameter 11 mm: 1.90.900.007/0000



THT LED 3 mm, without base

→ Color	Forward voltage typ. U_F at I_F	Max. current, I_F	Order no.
red	1.6 V / 1 mA	30 mA	1.90.690.228/0000
red	1.9 V / 20 mA	50 mA	1.90.690.269/0000
yellow	1.9 V / 20 mA	50 mA	1.90.690.267/0000
green	3.2 V / 20 mA	35 mA	1.90.690.684/0000
blue	3.6 V / 20 mA	30 mA	1.90.690.282/0000
white	3.6 V / 20 mA	30 mA	1.90.690.295/0000

FILAMENT/ NEON LAMPS



Wedge base W 2 x 4.6d, filament lamp, DIN 49846



→ Rated voltage	Rated current	Rated power	Diameter max.	Length	Medium operating life AC	Order no.
12 V	0.08 A	1.2 W	5 mm	20 mm	15,000 h	1.90.120.012/0000
24 - 30 V	0.04 A	1 W	5 mm	20 mm	1000 h	1.90.120.005/0000
24 V	0.04 A	1.2 W	5 mm	20 mm	7000 h	1.90.120.011/0000
48 V	0.025 A	1.2 W	5 mm	19 mm	2500 h	1.90.120.010/0000
60 V	0.02 A	1.2 W	5 mm	19 mm	3300 h	1.90.120.009/0000

Ratings and operating life specifications generally refer to the lower rated voltage value. Operating life specifications of lamps refer to AC operation. With DC operation, these are reduced by about 40%.

The lamps up to 30 V are provided with glass sockets, the other ones with plastic sockets.

Accessoires:

Lamp extractor for lamp diameter 5 mm: 1.90.900.003/0000

ACCESSORIES

FILAMENT/NEON LAMPS



Bi-Pin T 1 base, filament lamp

→ Rated voltage	Rated current	Rated power	Diameter max.	Length	Medium operating life AC	Order no.
24 - 28 V	0.016 A	0.4 - 0.56 W	-	-	5000 h	1.90.180.473/0000

Ratings and operating life specifications generally refer to the lower rated voltage value. Operating life specifications of lamps refer to AC operation. With DC operation, these are reduced by about 40%.

Accessoires:

Lamp extractor for lamp diameter 4 mm: 1.90.900.001/0000



Bi-Pin T 1/4 base, filament lamp

→ Rated voltage	Rated current	Rated power	Diameter max.	Length	Medium operating life AC	Order no.
12 V	0.06 A	0.72 W	4.3 mm	10.5 mm	10,000 h	1.90.180.474/0000
28 V	0.03 A	0.84 W	4.3 mm	10.5 mm	5000 h	1.90.180.475/0000

Ratings and operating life specifications generally refer to the lower rated voltage value. Operating life specifications of lamps refer to AC operation. With DC operation, these are reduced by about 40%.

Accessoires:

Lamp extractor for lamp diameter 4 mm: 1.90.900.002/0000



T 4.5 base, filament lamp

→ Rated voltage	Rated current	Rated power	Diameter max.	Length	Medium operating life AC	Order no.
12 V	0.04 A	0.48 W	4.2 mm	16.5 mm	10,000 h	1.90.100.022/0000

Ratings and operating life specifications generally refer to the lower rated voltage value. Operating life specifications of lamps refer to AC operation. With DC operation, these are reduced by about 40%.

Accessoires:

Lamp extractor for lamp diameter 4 mm: 1.90.900.002/0000

T 4.6 base, filament lamp



→ Rated voltage	Rated current	Rated power	Diameter max.	Length	Medium operating life AC	Order no.
12 V	0.04 A	0.3 W	4 mm	22 mm	5000 h	1.90.100.012/0000
24 V	0.02 A	0.5 W	4 mm	22 mm	5000 h	1.90.100.013/0000

Ratings and operating life specifications generally refer to the lower rated voltage value. Operating life specifications of lamps refer to AC operation. With DC operation, these are reduced by about 40%.

Accessoires:

Lamp extractor for lamp diameter 4 mm: 1.90.900.002/0000

BA 9s base (MBC/MCC), filament lamp, shape G, DIN 72601



→ Rated voltage	Rated current	Rated power	Diameter max.	Length	Medium operating life AC	Order no.
12 - 15 V	0.12 A	1.2 W	9 mm	24 mm	10,000 h	1.90.060.003/0000
24 - 30 V	0.04 A	1.2 W	9 mm	24 mm	7000 h	1.90.060.014/0000

Ratings and operating life specifications generally refer to the lower rated voltage value. Operating life specifications of lamps refer to AC operation. With DC operation, these are reduced by about 40%.

Accessoires:

Lamp extractor for lamp diameter 10.4 mm: 1.90.900.006/0000

BA 9s base (MBC/MCC), filament lamp, shape A, DIN 49851



→ Rated voltage	Rated current	Rated power	Diameter max.	Length	Medium operating life AC	Order no.
12 - 15 V	0.166 A	2 W	11 mm	29 mm	10,000 h	1.90.060.132/0000
24 - 30 V	0.083 A	2 W	11 mm	29 mm	10,000 h	1.90.060.133/0000
110 - 130 V	0.018 A	2 W	11 mm	30 mm	25,000 h	1.90.060.137/0000

Ratings and operating life specifications generally refer to the lower rated voltage value. Operating life specifications of lamps refer to AC operation. With DC operation, these are reduced by about 40%.

Accessoires:

Lamp extractor for lamp diameter 11 mm: 1.90.900.007/0000

ACCESSORIES

FILAMENT/NEON LAMPS



BA 9s base (MBC/MCC), neon lamp

→ Rated voltage	Rated current	Rated power	Diameter max.	Length	Medium operating life AC	Order no.
220 AC V	0.0015 - 0.0018 A	-	10 mm	24 mm	1500 h	1.90.560.002/0000

Ratings and operating life specifications generally refer to the lower rated voltage value. Operating life specifications of lamps refer to AC operation. With DC operation, these are reduced by about 40%.

Accessoires:

Lamp extractor for lamp diameter 11 mm: 1.90.900.007/0000



BA 9s base (MBC/MCC), neon lamp, DIN 49850

→ Rated voltage	Rated current	Rated power	Diameter max.	Length	Medium operating life AC	Order no.
AC 220 V	0.0015 - 0.0018 A	-	10 mm	28 mm	-	1.90.560.102/0000

Ratings and operating life specifications generally refer to the lower rated voltage value. Operating life specifications of lamps refer to AC operation. With DC operation, these are reduced by about 40%.

Accessoires:

Lamp extractor for lamp diameter 11 mm: 1.90.900.007/0000



BA 15d base, filament lamp, DIN 49850

→ Rated voltage	Rated current	Rated power	Diameter max.	Length	Medium operating life AC	Order no.
12 - 15 V	0.12 A	2 W	15.2/12.5 mm	31 mm	1000 h	1.90.070.003/0000
24 - 30 V	0.08 A	2 W	15.2/12.5 mm	31 mm	1000 h	1.90.070.004/0000

Ratings and operating life specifications generally refer to the lower rated voltage value. Operating life specifications of lamps refer to AC operation. With DC operation, these are reduced by about 40%.

Accessoires:

Lamp extractor for lamp diameter 14 mm: 1.90.900.008/0000

BA 15d base, filament lamp, DIN 49852



→ Rated voltage	Rated current	Rated power	Diameter max.	Length	Medium operating life AC	Order no.
24 - 30 V	0.165 A	4 W	17 mm	57 mm	2000 h	1.90.070.105/0000

Ratings and operating life specifications generally refer to the lower rated voltage value. Operating life specifications of lamps refer to AC operation. With DC operation, these are reduced by about 40%.

Accessoires:

Lamp extractor for lamp diameter 16-17 mm: 1.90.900.009/0000

BA 15d base, filament lamp



→ Rated voltage	Rated current	Rated power	Diameter max.	Length	Medium operating life AC	Order no.
24 V	0.2 A	5 W	16 mm	36 mm	2000 h	1.90.070.053/0000

Ratings and operating life specifications generally refer to the lower rated voltage value. Operating life specifications of lamps refer to AC operation. With DC operation, these are reduced by about 40%.

Accessoires:

Lamp extractor for lamp diameter 16-17 mm: 1.90.900.009/0000

E 10 (MES) base, filament lamp



→ Rated voltage	Rated current	Rated power	Diameter max.	Length	Medium operating life AC	Order no.
24 - 30 V	0.083 A	2 W	11 mm	29 mm	1000 h	1.90.010.033/0000
110 - 130 V	0.018 A	2 W	11 mm	30 mm	1000 h	1.90.010.037/0000

Ratings and operating life specifications generally refer to the lower rated voltage value. Operating life specifications of lamps refer to AC operation. With DC operation, these are reduced by about 40%.

Accessoires:

Lamp extractor for lamp diameter 11 mm: 1.90.900.007/0000

ACCESSORIES

FILAMENT/NEON LAMPS



E 10 (MES) base, neon lamp

→ Rated voltage	Rated current	Rated power	Diameter max.	Length	Medium operating life AC	Order no.
220 AC V	0.0015 - 0.0018 A	-	10.4 mm	28 mm	-	1.90.510.012/0000

Ratings and operating life specifications generally refer to the lower rated voltage value. Operating life specifications of lamps refer to AC operation. With DC operation, these are reduced by about 40%.

Accessoires:

Lamp extractor for lamp diameter 10.4 mm: 1.90.900.006/0000



E 14 base, shape B, filament lamp, DIN 49850

→ Rated voltage	Rated current	Rated power	Diameter max.	Length	Medium operating life AC	Order no.
24 - 30 V	0.083 A	2 W	14/12.5 mm	31 mm	1000 h	1.90.020.033/0000

Ratings and operating life specifications generally refer to the lower rated voltage value. Operating life specifications of lamps refer to AC operation. With DC operation, these are reduced by about 40%.

Accessoires:

Lamp extractor for lamp diameter 14 mm: 1.90.900.008/0000



E 14 base, filament lamp shape A, DIN 49852

→ Rated voltage	Rated current	Rated power	Diameter max.	Length	Medium operating life AC	Order no.
24 - 30 V	0.165 A	4 W	17 mm	57 mm	1000 h	1.90.020.105/0000
220 - 260 V	0.023 A	5 W	17 mm	57 mm	1000 h	1.90.020.115/0000

Ratings and operating life specifications generally refer to the lower rated voltage value. Operating life specifications of lamps refer to AC operation. With DC operation, these are reduced by about 40%.

Accessoires:

Lamp extractor for lamp diameter 16-17 mm: 1.90.900.009/0000

E 14 base, filament lamp



→ Rated voltage	Rated current	Rated power	Diameter max.	Length	Medium operating life AC	Order no.
220 - 260 V	0.02 - 0.03 A	5 - 7 W	16 mm	36 mm	1000 h	1.90.020.061/0000

Ratings and operating life specifications generally refer to the lower rated voltage value. Operating life specifications of lamps refer to AC operation. With DC operation, these are reduced by about 40%.

Accessoires:

Lamp extractor for lamp diameter 16-17 mm: 1.90.900.009/0000

E 14 base, neon lamp, shape B



→ Rated voltage	Rated current	Rated power	Diameter max.	Length	Medium operating life AC	Order no.
220 AC V	0.0014 - 0.0026 A	-	14.1/11.5 mm	31 mm	-	1.90.520.002/0000

Ratings and operating life specifications generally refer to the lower rated voltage value. Operating life specifications of lamps refer to AC operation. With DC operation, these are reduced by about 40%.

Accessoires:

Lamp extractor for lamp diameter 14 mm: 1.90.900.008/0000

Tubular lamp, S 8.5 base, filament lamp, shape L, DIN 72601

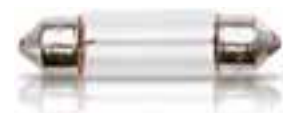

→ Rated voltage	Rated current	Rated power	Diameter max.	Length	Medium operating life AC	Order no.
24 V	-	3 W	11.5 mm	39 mm	200 h	1.90.111.003/0000

Ratings and operating life specifications generally refer to the lower rated voltage value. Operating life specifications of lamps refer to AC operation. With DC operation, these are reduced by about 40%.

ACCESSORIES

FILAMENT/NEON LAMPS



Tubular lamp, S 8.5 base, filament lamp, shape K, DIN 72601

→	Rated voltage	Rated current	Rated power	Diameter max.	Length	Medium operating life AC	Order no.
	24 V	-	5 W	15.5 mm	44 mm	200 h	1.90.111.103/0000

Ratings and operating life specifications generally refer to the lower rated voltage value. Operating life specifications of lamps refer to AC operation. With DC operation, these are reduced by about 40%.



Other accessories

Other accessories

ACCESSORIES

OTHER ACCESSORIES

Content

Accessories	5 - 19
RAFIX Insulating housing, Ø 16.2 mm	5 - 19
RAFIX Insulating housing IP65, Ø 22.3 mm	5 - 20
Emergency stop label, PVC adhesive, Ø 16.3 mm	5 - 21
Emergency stop label, Ø 22.3 mm	5 - 21
LUMOTAST 75 IP40/65 Blanking cap, black, Ø 16.2 mm	5 - 22
RAFIX 16 Blanking cap with sealing and threaded ring, Ø 16.2 mm	5 - 23
RAFIX 16 F Blanking cap	5 - 23
RAFIX 22 QR Blanking cap, Ø 22.3 mm	5 - 24
RAFIX 22 FS Blanking cap, Ø 22.3 mm	5 - 24
Fixing spanner	5 - 25
Fixing spanner for ring nut and front ring	5 - 25
Fixing spanner for hexagon nut	5 - 26
Lamp extractor	5 - 26
Disassembly tool	5 - 27
Female quick-connect terminal DIN 46340-B 2.8-1-MS	5 - 27
Plug distributor	5 - 27
LUMOTAST FK/25 Flat ribbon cable, 4-wire, length 1 m	5 - 28
LUMOTAST FK/25 Plug-in socket for PCB	5 - 28
LUMOTAST FK/25 Socket connector, 4-pin	5 - 28
LUMOTAST FK/25 Flat ribbon cable, 10 cm, with socket connector and AMP 4-pin male quick connector	5 - 29
LUMOTAST 75 IP40 Protective cap	5 - 29
LUMOTAST 75 IP40 Sealing cap for protection class IP 65	5 - 30
Signal lamp Ø 22.3 mm Sealing ring for IP 65	5 - 30
O-ring	5 - 31
Pushbuttons 16.2 mm Protection against contact	5 - 31
Signal lamps Protection against contact	5 - 31
Spacers, round	5 - 32
Spacers, triangular	5 - 33
RK 90 Spacer M 4	5 - 34

ACCESSORIES



RAFIX Insulating housing, Ø 16.2 mm

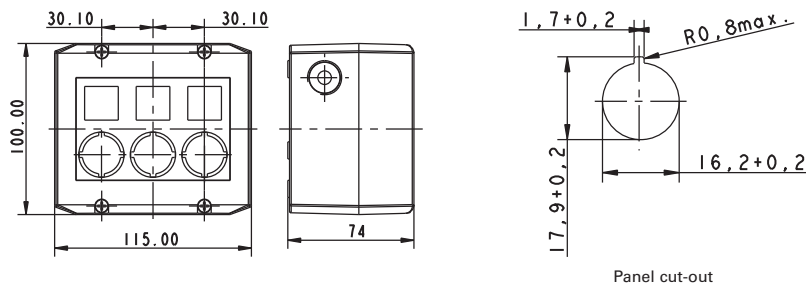

Panel cut-out

→ Description	Number of cut-outs	Ø	Dimensions	Order no.
RAFIX - Insulating housing, Ø 16.2 mm, IP65, 1-module, light grey/dark grey	1	16,2 mm	100x55x74 mm	1.20.810.001/0000
RAFIX - Insulating housing, Ø 16.2 mm, IP65, 1-module, yellow/yellow	1	16,2 mm	100x55x74 mm	1.20.810.002/0000
RAFIX - Insulating housing, Ø 16.2 mm, IP65, 2-module, light grey/dark grey	2	16,2 mm	100x115x74 mm	1.20.820.001/0000
RAFIX - Insulating housing, Ø 16.2 mm, IP65, 3-module, light grey/dark grey	3	16,2 mm	100x115x74 mm	1.20.830.001/0000
RAFIX - Insulating housing, Ø 16.2 mm, IP65, 4-module, light grey/dark grey	4	16,2 mm	100x145x74 mm	1.20.840.001/0000

- Attractive plastic housing to accommodate up to 4 control components
- 2 cable entries prepared: 1-,2-,3-part: M20x1.5, 4-part: M25x1.5
- Degree of protection IP65 to DIN EN 60529
- All grey housings with overlay, legending possible with legend inserts
- Wall mounting with 2 screws through housing bottom prepared
- Dimensions (feature 1) x 100 mm x 74 mm
- Accessories: 50 pre-perforated legend inserts on a DIN A4 sheet
- Housings with other features, e.g. RAFX 16F, on request.

ACCESSORIES

HOUSING

– Table (continued) –
RAFIX - Insulating housing, Ø 16.2 mm

Accessoires:

Label sheet for housing (50 foil legend inserts): 5.40.451.283/0000



RAFIX Insulating housing IP65, Ø 22.3 mm

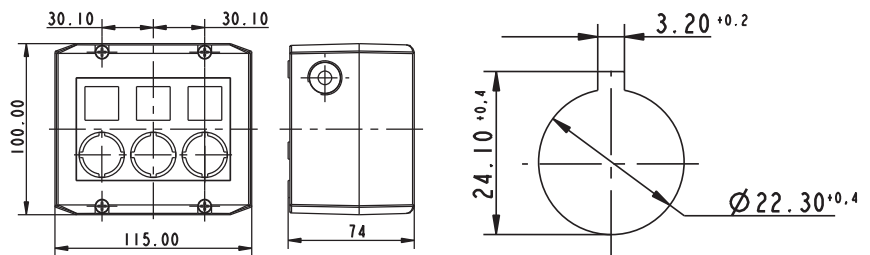

Panel cut-out to IEC 60947-5-1

→ Description	Number of cut-outs	Ø	Dimensions	Order no.
RAFIX - Insulating housing, Ø 22.3 mm, IP65, 1-module, light grey/dark grey	1	22,3 mm	100x55x74 mm	1.20.810.201/0000
RAFIX - Insulating housing, Ø 22.3 mm, IP65, 1-module, yellow/yellow	1	22,3 mm	100x55x74 mm	1.20.810.202/0000
RAFIX - Insulating housing, Ø 22.3 mm, IP65, 2-module, light grey/dark grey	2	22,3 mm	100x115x74 mm	1.20.820.201/0000
RAFIX - Insulating housing, Ø 22.3 mm, IP65, 3-module, light grey/dark grey	3	22,3 mm	100x115x74 mm	1.20.830.201/0000
RAFIX - Insulating housing, Ø 22.3 mm, IP65, 4-module, light grey/dark grey	4	22,3 mm	100x145x74 mm	1.20.840.201/0000

- Plastic housing to accommodate up to 4 control components
- 2 cable entries prepared: 1-,2-,3-part: M20x1.5, 4-part: M25x1.5
- Degree of protection IP65 to DIN EN 60529
- All grey housings with overlay, legending possible with legend inserts
- Wall mounting with 2 screws through housing bottom prepared
- Dimensions: (feature 1) x 100 mm x 74 mm
- Accessories: 50 pre-perforated legend inserts on a DIN A4 sheet

Accessoires:

Label sheet for housing (50 foil legend inserts): 5.40.451.283/0000

5

Others

Emergency stop label, PVC adhesive, Ø 16.3 mm



→ Dimensions	inside Ø	Label	Order no.
Ø 40 mm	16.3 mm	„NOT-HALT, EMERGENCY STOP, ARRET D'URGENCE, EMERGENZA“	5.76.204.114/0400
Ø 40 mm	16.3 mm	4 x „NOT-HALT“	5.76.204.116/0400
Ø 40 mm	16.3 mm	4 x „NOT-AUS“	5.76.204.118/0400
Ø 40 mm	16.3 mm	4 x „EMERGENCY STOP“	5.76.204.120/0400
Ø 60 mm	16.3 mm	-	5.76.204.400/0400
Ø 60 mm	16.3 mm	1 x „NOT-AUS“	5.76.204.401/0400
Ø 60 mm	16.3 mm	1 x „EMERGENCY STOP“	5.76.204.403/0400
Ø 60 mm	16.3 mm	„NOT-HALT, EMERGENCY STOP, ARRET D'URGENCE, EMERGENZA“	5.76.204.106/0400
Ø 60 mm	16.3 mm	4 x „NOT-HALT“	5.76.204.108/0400
Ø 60 mm	16.3 mm	4 x „NOT-AUS“	5.76.204.110/0400
Ø 60 mm	16.3 mm	4 x „EMERGENCY STOP“	5.76.204.112/0400

Emergency stop label, Ø 22.3 mm

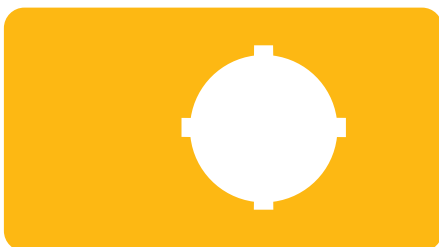

→ Dimensions	inside Ø	Label	Order no.
36 x 64 mm	22.3 mm	-	5.76.205.011/0400
Ø 40 mm	22.3 mm	„NOT-HALT, EMERGENCY STOP, ARRET D'URGENCE, EMERGENZA“	5.76.204.115/0400
Ø 40 mm	22.3 mm	4 x „NOT-HALT“	5.76.204.117/0400

ACCESSORIES

EMERGENCY STOP LABELS / BLANKING CAPS

– Table (continued) –
Emergency stop label, Ø 22.3 mm

→ Dimensions	inside Ø	Label	Order no.
Ø 40 mm	22.3 mm	4 x „NOT-AUS“	5.76.204.119/0400
Ø 40 mm	22.3 mm	4 x „EMERGENCY STOP“	5.76.204.121/0400
Ø 60 mm	22.3 mm	1 x „NOT-AUS“	5.76.207.001/0400
Ø 60 mm	22.3 mm	„EMERGENCY-STOP / ARRET D'URGENCE“	5.76.207.002/0400
Ø 60 mm	22.3 mm	1 x „NOT-AUS“	5.76.204.101/0400
Ø 60 mm	22.3 mm	1 x „ARRET D'URGENCE“	5.76.204.102/0400
Ø 60 mm	22.3 mm	1 x „EMERGENCY STOP“	5.76.204.103/0400
Ø 60 mm	22.3 mm	„NOT-HALT, EMERGENCY STOP, ARRET D'URGENCE, EMERGENZA“	5.76.204.107/0400
Ø 60 mm	22.3 mm	4 x „NOT-HALT“	5.76.204.109/0400
Ø 60 mm	22.3 mm	4 x „NOT-AUS“	5.76.204.111/0400
Ø 60 mm	22.3 mm	4 x „EMERGENCY STOP“	5.76.204.113/0400



LUMOTAST 75 IP40/65 Blanking cap, black, Ø 16.2 mm



→ Installation dimensions	Dimenions	Color	Order no.
Ø 16,2 mm	18 x 18	black	5.52.006.020/0103
Ø 16,2 mm	18 x 24	black	5.52.006.021/0100
Ø 16,2 mm	Ø 18	black	5.52.006.022/0100

5

Others

RAFIX 16 Blanking cap with sealing and threaded ring, Ø 16.2 mm



→ Description	Order no.
Blanking cap complete with sealing disc and ring nut, square	5.05.800.049/0100
Blanking cap complete with sealing disc and ring nut, round	5.05.800.050/0100
Blanking cap complete with sealing disc and ring nut, square, alignable without gaps	5.05.800.051/0100

RAFIX 16 F Blanking cap

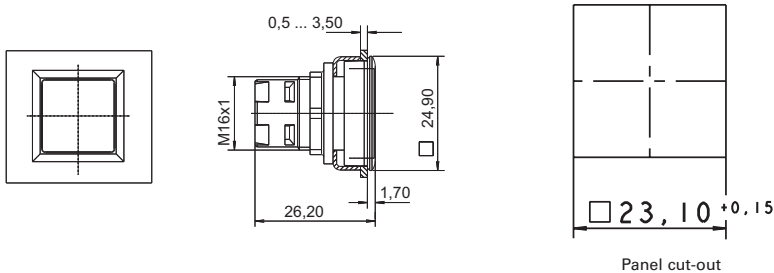

→ Installation dimensions	Dimenions	Color	Order no.
23,1 x 23,1 mm	24,9 x 24,9	black	5.05.800.063/0000

ACCESSORIES

BLANKING CAPS



RAFIX 22 QR Blanking cap, Ø 22.3 mm



round blanking cap

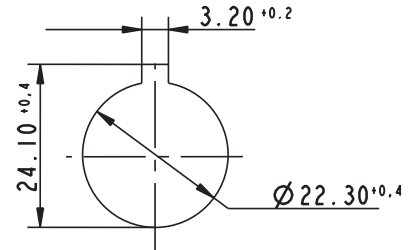

Panel cut-out to IEC 60947-5-1

→ Description	Order no.
Blanking cap IP65, ring nut, square, slate grey	5.05.800.065/0000
Blanking cap IP65, ring nut, round, slate grey	5.05.800.064/0000

Protection acc. to DIN EN 60529

RAFIX 22 FS Blanking cap, Ø 22.3 mm

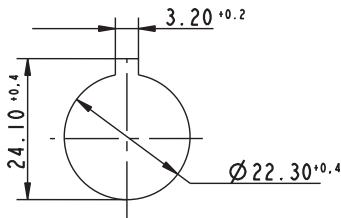

Panel cut-out to IEC 60947-5-1



round, high version



square blanking cap

→ Description	Form	Overall height	Order no.
Blanking cap IP65, ring nut, round, slate gery, flat	round	flush	5.05.800.067/0000
Blanking cap IP65, ring nut, round, high version, can be used for covering mounted PCB contact blocks.	round	high	5.05.200.025/0000
Blanking cap IP65, ring nut, square, slate grey, flat	square	flush	5.05.800.068/0000
Blanking cap IP65, ring nut, square, high version, can be used for covering mounted PCB contact blocks.	square	high	5.05.200.026/0000

Fixing spanner



→ Fitting for	Order no.
M 8	5.58.002.027/7705
M 9, M 10	5.58.002.025/0105
M 11, M 13	5.58.002.026/0105
M 15, M 16	5.58.002.019/0105
M 18, M 19	5.58.002.017/0105
M 20, M 22	5.58.002.018/0105
M 25, M 30	5.58.002.020/0105

Fixing spanner for ring nut and front ring



→ Description	Fitting for	Order no.
Fixing spanner for ring nut	RAFIX 22 QR/FS	5.05.800.062/0000

Fixing spanner for hexagon nut



→ Fitting for	Order no.
RAFIX 16	5.58.002.034/0000

Lamp extractor



→ Lamp diameter	Order no.
4 mm	1.90.900.001/0000
4 mm	1.90.900.002/0000
5 mm	1.90.900.003/0000
5 - 6 mm	1.90.900.004/0000
7 mm	1.90.900.005/0000
10.4 mm	1.90.900.006/0000
11 mm	1.90.900.007/0000
14 mm	1.90.900.008/0000
16-17 mm	1.90.900.009/0000

Disassembly tool

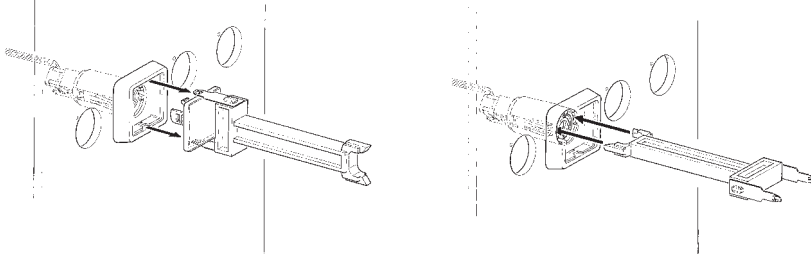

→ Fitting for	Order no.
LUMOTAST FK	5.05.800.041/0000
LUMOTAST 25, RAFIX 16	5.05.800.042/0000

Female quick-connect terminal DIN 46340-B 2.8-1-MS



→ Description	Order no.
Female quick-connect terminal DIN 46340-B 2.8-1-MS	5.37.540.024/8622

With latching detent for mating with a multipole connector.

Plug distributor



→ Description	Order no.
Plug distributor	5.37.540.029/6000

For mounting on the quick-connect terminals of contact blocks. The double number of contacts facilitates loop-through.



LUMOTAST FK/25

Flat ribbon cable, 4-wire, length 1 m

→ Description	Order no.
Flat ribbon cable, 4-wire, 1 m long	5.37700.124/0000



LUMOTAST FK/25

Plug-in socket for PCB

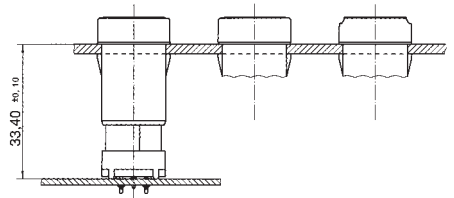
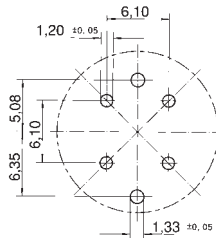

with plug-in socket for PCB

→ Description	Order no.
Plug-in socket for PCB	5.00.645.036/0000



LUMOTAST FK/25

Socket connector, 4-pin

→ Description	Order no.
Socket connector, 4-pin	5.92.025.368/0000

LUMOTAST FK/25

Flat ribbon cable, 10 cm, with socket connector and AMP 4-pin male quick connector



→ Description	Order no.
Cable (flat ribbon cable 10 cm with socket connector and male quick connector, AMP 4-pin)	5.03.771.306/0000

LUMOTAST 75 IP40

Protective cap



→ Description	Order no.
LUMOTAST 75 IP40 - Protective cap for 18 x 24 collar	5.05.800.027/0000
LUMOTAST 75 IP40 - Protective cap for 18 x 18 collar	5.05.800.030/0000



LUMOTAST 75 IP40 Sealing cap for protection class IP 65



→ Description	Order no.
LUMOTAST 75 IP40 - Sealing cap for protection class IP65, for 18 x 24 collar	5.05.200.008/0000
LUMOTAST 75 IP40 - Sealing cap for protection class IP 65, for 18 x 18 collar	5.05.200.009/0000



Signal lamp Ø 22.3 mm Sealing ring for IP 65

→ Description	Order no.
Sealing ring for IP65	5.30.075.010/0100

O-ring



→ Description	Order no.
O-ring, black, for blocking the operating stroke	5.30.120.009/0100
O-ring for keylock switch	5.30.120.015/0100
O-ring, black, 17.0 x 1.5, for blocking RF 19H keys	5.30.125.003/0100
O-ring, black, 16.0 x 1, for blocking RF 19H keys	5.30.125.007/0100

Pushbuttons 16.2 mm Protection against contact



→ Description	Order no.
Protection against contact to VBG 4	5.55.101.715/0200

Signal lamps Protection against contact



→ Description	Order no.
Protection against contact to VBG 4	5.50.240.063/0209
Protection against contact to VBG 5	5.50.240.065/0200

ACCESSORIES

SPACERS



Spacers, round

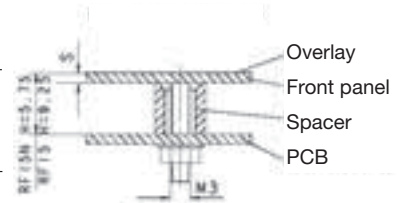
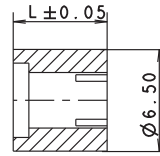
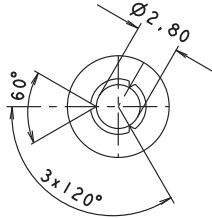

→ Length L	Color	Order no.
3.50 mm	blue transparent	5.30.759.023/0000
4.75 mm	blue transparent	5.30.759.028/0000
5.25 mm	yellow orange transparent	5.30.759.030/0000
4.50 mm	red	5.30.759.027/0000
5.50 mm	yellow	5.30.759.031/0000
4 mm	green	5.30.759.025/0000
5.75 mm	green	5.30.759.032/0000
6.2 mm	blue	5.30.759.251/0000
4.25 mm	blue	5.30.759.026/0000
6 mm	blue	5.30.759.033/0000
5 mm	black	5.30.759.029/0000
10.00 mm	black	5.30.759.043/0104
6.25 mm	red	5.30.759.034/0000
6.50 mm	blue transparent	5.30.759.035/0000
6.75 mm	black	5.30.759.036/0000
7 mm	yellow orange transparent	5.30.759.037/0000
7.25 mm	yellow	5.30.759.038/0000
7.50 mm	green	5.30.759.039/0000
7.75 mm	blue	5.30.759.040/0000
8 mm	red	5.30.759.041/0000
8.25 mm	blue transparent	5.30.759.042/0000

Required spacer length

For keyboards: Overall height of key - front panel thickness - 0.5 mm (area embossing).

For RAFIX 22 FS: 9.25 mm - front panel thickness - thickness of overlay, if existing

Spacers, triangular

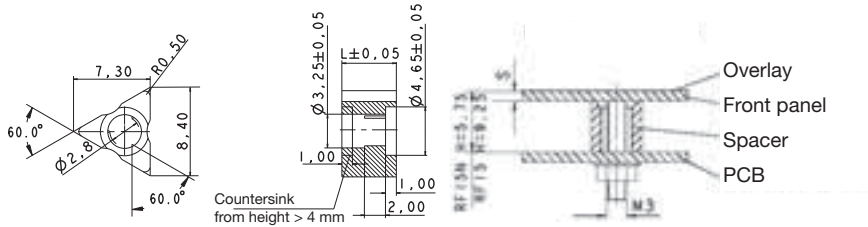

triangular version

→ Length L	Order no.
2.50 mm	5.30.759.094/0000
2.75 mm	5.30.759.095/0000
3 mm	5.30.759.096/0000
3.25 mm	5.30.759.097/0000
3.50 mm	5.30.759.098/0000
3.75 mm	5.30.759.099/0000
4 mm	5.30.759.100/0000
4.25 mm	5.30.759.101/0000
4.50 mm	5.30.759.102/0000
4.75 mm	5.30.759.103/0000
5 mm	5.30.759.104/0000
5.25 mm	5.30.759.105/0000
5.50 mm	5.30.759.106/0000
5.75 mm	5.30.759.107/0000
6 mm	5.30.759.108/0000
6.2 mm	5.30.759.253/0000
10.00 mm	5.30.759.124/0000
10.25 mm	5.30.759.125/0000
6.25 mm	5.30.759.109/0000
6.50 mm	5.30.759.110/0000
6.75 mm	5.30.759.111/0000
7 mm	5.30.759.112/0000
7.25 mm	5.30.759.113/0000
7.50 mm	5.30.759.114/0000
7.75 mm	5.30.759.115/0000
8 mm	5.30.759.116/0000
8.25 mm	5.30.759.117/0000
9 mm	5.30.759.254/0000

ACCESSORIES

SPACERS

– Table (continued) – Spacers, triangular

Required spacer length = Overall height of key - front panel thickness - 0.5 mm (area embossing).



RK 90 Spacer M 4

→ Length L	Color	Order no.
12.5 mm overall height for RF 15 mm	-	5.30.764.040/0000
9.25 mm overall height, for RF 15 mm	-	5.30.764.027/0000
5.5 mm overall height, for RF15 N mm	-	5.30.764.010/0000
7.5 mm overall height for RACON 8/12 mm	-	5.30.764.018/0000
4.25 mm overall height, for RACON 8/12 mm	-	5.30.764.005/0000

Mounting from front (1 pc. per stud)

6

APPENDIX

Glossary

6 - 1

Reference number guide

6 - 20

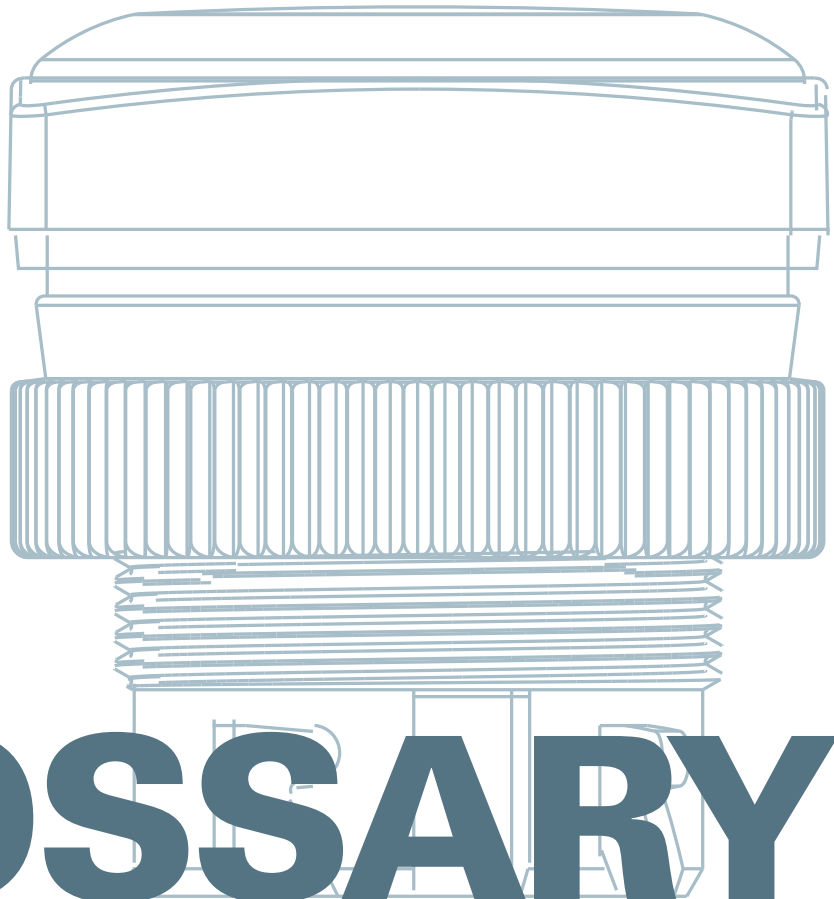

GET IN TOUCH GLOSSARY

1	16.2 mm	Mounting hole acc. to IEC 60947-5-1
2	22.3 mm	Mounting hole acc. to IEC 60947-5-1
	2-Shot molding	Using this procedure the symbol is separately molded. Then the appropriate keycap form is molded around it. Advantage: The character becomes an integrated part of the keycap, thus eliminating abrasion.
3	30.5 mm	Mounting hole acc. to IEC 60947-5-1
9	9.2 mm	A RAFI-specific mounting dimension. With a mounting depth of 9.2 mm behind the front panel surface, the printed circuit board can be installed and carry RAFI components such as MICON 5, RACON 8, RACON 12, KN 19, RF 15, RF 19 and RAFIX 22 FS contact blocks.
	9.7 mm	Overall height (with plunger if applicable) for RAFI short-travel keyswitches MICON 5, RACON 8, RACON 12, KN 19, RF 15, RF 19 for use under an overlay.
A	Actuator	The component which is pressed by the operator. Actuators are always located on the surface of a machine.
	Ambient temperature	Minimum and maximum permissible temperature (°C) in the environment of the component.
	Assembly without tools	An assembly process performed without any auxiliary items.
	AWG – American Wire Gauge	A unit of measurement for thickness and diameter of solid and stranded wires.
B	Barred area	The area around a PCB component where no other components are allowed.
	Blanking cap	Used to cover mounting holes without function.
	Blister reel	A deep-drawn endless packaging type with a transparent cover strip used for automatic feeding of components to automatic SMT assembly machines.
	Breakdown voltage	The voltage (V, kV) that is necessary to cause current to flow through an insulator.
	Buzzers	A signalling unit generating an acoustic signal (piezo type).
C	Cage clamp terminal	A static contact for connecting a wire (by a self-locking spring) to integrate components into circuits.
	CCC	The China Compulsory Certificate (CCC) is required in China for various product groups, especially for electrical products. Products that are subject to certification may not be imported into China and sold there without the CCC mark.
	CE marking	A quality mark for devices complying with the European Low-Voltage Directive. The CE mark means that the device marked complies with all relevant requirements and standards. See also the glossary table on pages 6-12.
	Change-over contact	Mechanically interconnected normally-open (NO) contact and normally-closed (NC) contact with a common potential.
	Click fixing method	For mounting pushbuttons from the front (LUMOTAST FK, LUMOTAST 25).
	Collar	The housing of an actuator.
	Collar shape	May exist in different designs; common collar shapes are round or square.
	Color coding to IEC/ EN 60073, IEC 60204 (VDE 0113, Part 1)	Red – Emergency (Warning of a potential hazard -> Immediate intervention required) Yellow – Abnormal condition (critical condition) Green – Normal condition (indicates safe operating conditions) Blue – Mandatory (action required) White – No special meaning Grey – No special meaning Black – No special meaning (see also table on pages 6-10ff.)
	Contact block	Contact element for opening or closing a circuit. Contact blocks may contain several different potential-free contact chambers.

GLOSSARY

ELECTROMECHANICAL COMPONENTS

C	Contact block product marketing	See table in glossary on pages 6-13.
	Contact chamber	The enclosed space around a switching contact.
	Contact resistance	The resistance between closed contacts (constriction resistance, surface contamination resistance, etc.).
	Contacts	Contacts are distinguished according to static and separable contacts. Static contacts include temporary or permanent connections (screw connections, solder connections, etc.). Separable contacts are referred to as switching contacts in circuits.
	Control component	Components designed to input commands on a machine. Control components have a modular design. They are made from actuators and contact blocks, and therefore offer maximum flexibility with regard to the selection of the suitable input components.
	Conventional thermal current Ith EN IEC 60947-5-1	The maximum current (A) that a switching device can conduct without thermal overload for at least 8 hours.
	Creepage distance EN IEC 60947-1, IEC EN 61058	Describes the shortest distance (mm) between two conductive parts on the surface of an insulating material.
	CSA	Canadian Standards Association
	CSA "NRTL/C"	Approval label for Canada and the U.S.A., tested by CSA acc. to CSA C 22.2 14-M91 and UL 508.
CURus	Approval label for the U.S.A. and Canada, tested by UL acc. to UL 508 and CSA C22.2 14-M91.	
D	Declaration of conformity	Declarations of conformity are available upon request for all products. Please specify the accurate order numbers of the specific products in your inquiry.
	Degree of contamination DIN EN 60947-1	A measure for the quantity of conductive or hygroscopic dust, gas or salt and the relative humidity which may cause a reduction of the dielectric strength of a switching device. The degree of contamination is described with four different levels for the definition of the ambient conditions. Degree of contamination 2: Domestic appliances, Degree of contamination 3: Industry, Degree of contamination 4: Outdoor use
	Degree of protection	See table in glossary on pages 6-14.
	Diffuser lens	A lens diffusing a light signal into many directions. Diffusers are used with signal lamps for visual indication from a distance and are not suitable for legending.
	Double gap	A contact type with two switching contact breaking points.
E	Dupe-proof	A feature of emergency stop switches according to EN 60947-5-5. Dupe-proof means that the initiation of a component cannot be cancelled as soon as a certain point is reached when operated by an accumulated force.
	Electric arc	A self-sustaining discharge phenomenon between two electrodes.
	Electrical operating life	The number of operations of a component at a defined electrical load.
	EMC	EMC = Electromagnetic compatibility The components listed in this catalogue are "elementary components such as switches, signal lamps, etc." according to the electromagnetic compatibility (EMC) legislation and are therefore not subject to the EMC legislation.
	Emergency stop	Emergency stop switches (EN 60947-5-5) are safety-relevant actuators with a mechanical latching function. Emergency stop switches can be used for the emergency stop function of a machine or device to IEC EN 13850 and operate according to different stop categories (depending on the safety application). The following criteria apply according to the EC Machinery Directive: - An emergency stop switch must be ready to use at any time. - One actuation must result in immediate disconnection (shutdown). - Resetting an emergency stop switch must not initiate restarting. - The switching device must latch when pressed. - There must be unambiguous identification (red/yellow). The original operating instructions can be found on pages 6-16f.

E	ENEC approval	European approval mark for device switches according to IEC 61058-1. This European approval replaces all national approval marks in Europe, such as VDE, SEV, ÖVE, DEMKO, SEMKO, NEMKO, FEMKO and KEMA. Many RAFI products have already obtained approval according to the new approval procedure while others are under preparation. Explanation of the ENEC ratings – Example: 25T85 (70) means: - Lower temperature: - 25°C – Upper temperature: + 85°C (without lamp) – Upper temperature: + 70°C (with lamp).
	Engraving	This labour-intensive procedure involves engraving the desired symbol into the keycap and coloring it. Suitable only for small quantities.
	ESD strength	The dielectric strength (kV) of a component with static charge.
	Extension plunger	An accessory for short-travel keyswitches used for adapting the actuating area to obtain different widths and heights.
F	Filament lamp	A lamp the light of which is generated by a hot filament wire. The wire is enclosed in a vacuum in order to prevent it from burning.
	Fixing nut	Used for fixing the device in the front panel.
	Fixing spanner	Assembly tool for optimum component assembly.
	Flammability class	Specifies the flammability of a product. For details, see table in glossary on pages 6-12.
	Front ring	Design element of RAFIX 22 FS+ and RAFIX 22 QR control components.
	Full-travel keyswitch	An electromechanical keyswitch with a travel from 1 to 5 mm optimised for quick data input.
G	Glow wire test to IEC 60695-2	The test temperature of 850°C means that these products can be used in devices designed for unattended continuous operation.
	Gold contact	Contacts used for switching low currents and voltages (signal level).
	Grid spacing	Defines the distance to the next adjacent component of the same type.
	Gullwing terminals	Solder terminals bent towards the outside, used for SMT components.
H	Hall technology	The Hall effect occurs in a current-carrying conductor located within a magnetic field, where an electrical field builds up which is perpendicular to the direction of current and to the magnetic field and which compensates the Lorentz force acting on the electrons. The Hall effect can be utilised for switching and positioning purposes. The switching method of the RS 76C is based on this technology.
	Handle	The part of a selector switch used for turning and operating the switch.
	Hot stamping	Often referred to as foil stamping, transmits preprint pictures by pressure and heat to be decorated plastic.
	Housings alignable without gaps	Control components with a housing collar suitable for aligning without gaps make it possible to design an operating panel without gaps between the components. There is no clearance between the housings of the various actuators. This prevents accumulation of dirt.
I	IEC 60947-5-1	Low-voltage switchgear and controlgear. Part 5-1: Control circuit devices and switching elements, electromechanical control circuit devices, DIN EN 60947-5-1, VDE 0660, Part 200.
	IEC 60947-5-5	Low-voltage switchgear and controlgear. Part 5-5: Control circuit devices and switching elements, electrical emergency stop device with mechanical latching function, DIN EN 60947-5-5, VDE 0660, Part 210.
	IEC 60204-1	Electrical equipment of machines. Part 1: General requirements: DIN EN 60204-1, VDE 0113, Part 1.
	IEC 60529	Degrees of protection by housings: DIN EN 60529, VDE 0470, Part 1.
	IEC 61058-1	Device switches. Part 1: General requirements: DIN EN 61058-1, VDE 0630, Part 1.
	Illuminated pushbutton	A pushbutton which can be illuminated for visual signal indication.
	Illumination	Used for visual signal indication with illuminated pushbuttons, indicator lights, signal lamps, pushbuttons, etc. The illumination can be implemented with various luminous elements mounted either in sockets or permanently.

GLOSSARY

ELECTROMECHANICAL COMPONENTS

I	Indicator light	A signal lamp indicating a status by lighting up or going out.
	Indicators	Components designed for giving a signal to the operator.
	Insulation resistance IEC 60093	The resistance (k Ω , M Ω) between different poles of an electromechanical contact and live parts.
J	J-lead	Solder terminals bent towards the inside, used for SMT components.
	JEDEC	Abbreviation of Joint Electron Device Engineering Council. The JEDEC Solid State Technology Association (in short, JEDEC) is a US organisation for the standardisation of semiconductors. One of its fields of activity is the definition of binding standards for soldering (example: JEDEC 20D soldering standard with RoHS conformity).
K	Keycap	Visible actuating area of a key which is removable, legendable, opaque, translucent or transparent.
	Keylock switch	A switching element provided with a priority function, where the key is used as the actuator. For its keylock switches, RAFI only uses key cylinders from reputed keylock system manufacturers. Keylock switches are open mechanical systems that can require operator maintenance depending on the ambient conditions. Refer to the supplier instructions for details on their care.
	Keypad	A signal-generating switching unit closing (or opening) a circuit when operated. The circuit opens (or closes, respectively) again after operation.
	KN 19	Short-travel main switch for low-profile data entry systems, overall height of RAFI KN 19: 9.2 mm
L	Label holder	Legend label modules which can be mounted separately for control components of the RAFIX 16 and RAFIX 22 QR series.
	Lamp	A luminous element with artificial light used for illumination.
	Lamp socket	An element which can accommodate a standard luminous element with a specific base.
	Laser engraving	A recommended legending technique for use when complete keyboards are needed with different layouts, for example. RAFI has various legends available for this purpose. The keyboards can then be prepared as required on a short-term basis. This type of legending is also suitable for medium to large quantities.
	Latching	The contact remains in the switching position when operated once.
	Latching function	The contact remains in the switching position when operated once.
	LED	A light emitting diode used, for example, for indicating a signal status. LEDs can be operated either with direct current (DC) or with alternating current (AC).
	LED clip	A special LED-type luminous element for RAFIX 22 FS control components that can be used with contact blocks with quick-connect terminals.
	Legending	Required to identify the effects of the specific input or output signal. Legending technologies used by RAFI: <ul style="list-style-type: none"> - Engraving - Hot stamping - Pad printing - 2-Shot moulding - Laser engraving - etc.
	Legend insert	When using keycaps with an exchangeable legend insert (e.g. RAFIX 22 FLEX-LAB), it is possible to print or engrave the legend insert. Since the inserts have a cover to protect them, they do not wear off.
	Lens	The part of a pushbutton which an operator touches directly. Lenses are provided with different colors to identify the effect of pressing the pushbutton.
	Locating pip	A projection provided for locating an actuator. Panel cut-outs complying with IEC 60 947-5-1 are provided with the matching groove, or indent.
	Luminous element	A term designating electric components emitting light.
LUMOTAST	A brand name for RAFI pushbutton series that have been offered as mono-elements for more than 35 years. The current LUMOTAST series include: LUMOTAST FK, LUMOTAST 22, LUMOTAST 25, LUMOTAST 75	

L	LUMOTAST FK	An illuminated pushbutton and signal lamp product series suitable for mounting from the front and provided with a flat ribbon cable connection.
	LUMOTAST 22	An emergency stop device suitable for mounting from the front.
	LUMOTAST 25	An illuminated pushbutton and signal lamp product series suitable for mounting from the front, with a collar size of 25 x 25 mm and provided with a flat ribbon cable connection.
	LUMOTAST 75	An illuminated pushbutton and signal lamp product series suitable for mounting from the front for applications up to 250 V.
M	Make/break arc	An arc caused when making and breaking a contact, having a detrimental effect on the electrical operating life.
	Make current	The current flowing immediately after initial power-on and which may be a multiple of the rated current flowing later.
	Marking	Marking is made in accordance with the Low-Voltage Directive 72/33/EEC or the CE Marking Directive 93/68/EEC in the shipping documents, on the packaging or on the product itself.
	Materials	See "Plastic materials".
	Mechanical operating life	Number of mechanical operations of a component.
	Momentary contact function	Signal transfer only when actuated – Circuit is closed or open as long as the actuation persists.
	Mono-element	Complete element consisting of actuator and contact block.
	Mounting depth	The space required for RAFI components behind the front panel. The mounting depth always includes the front panel thickness, which may vary.
	Mounting hole	A round or square cut-out in the front panel used for installing RAFI components. Mounting holes may be standardised, e.g. according to EN 60 947-5-1.
	Mushroom head	The actuating area of a mushroom pushbutton.
	Mushroom pushbutton	A pushbutton with an enlarged actuating area.
N	Neon lamp	A lamp the light of which is generated by electrical discharge effects in thinned gas. Such lamps offer the advantages of low heat loss, a long operating life and excellent shock resistance.
	Normally-closed contact (NC)	A contact breaking (opening) a circuit when operated (normally closed).
	Normally-open contact (NO)	A contact closing a circuit when actuated (normally open).
O	Opaque	Non-transparent material structure used, for example, with colored lenses of pushbuttons (see also "Transparent" and "Translucent").
	Operating force	The force (N) which must be exerted on an actuator in order to be able to initiate the intended function.
	Operating point	The position in the switching process where the contact closes or opens.
	Operating temperature	Admissible ambient temperature range during operation.
	Operating torque	The force to be applied to input a command with a selector switch or keylock switch.
	Operating travel	The travel of a pushbutton, mushroom pushbutton, emergency stop button, etc. required for command input.
	Operations according to EN IEC 61058-1	Refers to the complete cycle of a logical change of state until back in the initial position.

GLOSSARY

ELECTROMECHANICAL COMPONENTS

	Pad printing	Keycaps can be printed using two-component ink on special request. This type of legending is not very wear-resistant. The technique is suitable for medium quantities.
	Panel mounting sockets	Sockets for accommodating filament lamps and LEDs provided with a base.
	Plastic material	Housings, keycaps and lenses are exclusively made of thermoplastic or thermosetting plastic materials with excellent electrical characteristics, high impact resistance and high temperature resistance. We do not use any cadmium for surface protection of contact and connection elements and we only use cadmium-free plastic materials and asbestos-free filling materials. Cadmium-containing and cadmium-free plastics have the same technical characteristics, and equivalent quality is confirmed by the manufacturers. One limitation of plastic is the consistency of hue, where in some cases it can be noticed by visual inspection. However, in general the difference can only be detected by measuring equipment.
P	Positive opening operation according to EN IEC 60947-5-1, Annex K	Describes the mechanical movement of a normally-closed contact which guarantees that the contact opens when the actuator is in the corresponding open position.
	Potentiometer drive	An actuator of control components used for operating a potentiometer.
	Previous products	In this catalogue, we present the current RAFI product range. Many articles from previous product ranges are still available. Please contact your usual RAFI distribution partners.
	Priority keylock switch	Offers various functions/switching positions with different keys.
	Protection class IEC 61058-1	Protection class 1: With protective ground terminal, Protection class 2: With protective insulation (double-insulated), Protection class 3: Protective extra low voltage
	Pushbutton	Pushbuttons are actuators operated by pressing. Pushbuttons may have a momentary or latching switch function.
Q	Quick-connect terminals	A static contact for connecting a wire (with a quick-connect blade terminal for cable lugs) to integrate components into circuits.
R	RACON 8	RAFI short-travel keyswitch in square design with an edge length of 8 mm and sealed gold contact system.
	RACON 12	RAFI short-travel keyswitch in square design with an edge length of 12 mm and sealed gold contact system.
	RAFIX	The brand name of the RAFI control component series. The RAFIX brand is more than 40 years old. The current RAFIX generation includes the following series: RAFIX 16, RAFIX 16 F, RAFIX 22 FS+, RAFIX 22 QR, RAFIX 30 FS, RAFIX FSR
	RAFIX 16	A complete control component series designed for a mounting hole diameter of 16.2mm.
	RAFIX 16 F	A design-oriented control component series with a very low profile.
	RAFIX 22 FS+	A control component series designed for a mounting hole diameter of 22.3 mm. Special characteristics of this series are: – Low mounting depth – Easy assembly – Compatibility with short-travel keyswitches
	RAFIX FSR	A control component series for rugged applications, based on RAFIX FS technology.
	RAFIX 22 QR	A complete control component series designed for a mounting hole diameter of 22.2mm.
	RAFIX 30 FS+	A control component series for flat mounting with a mounting hole diameter of 30 mm and based on RAFIX FS technology.
	Rated operating voltage (U _e) IEC 60947-1	The voltage that together with the rated operating current determines how the device can be used.
	Rated operating current (I _e) IEC 60947-1	The amperage (A) a switching device may conduct, taking the rated operating voltage, the operating time, the usage category and the ambient temperature into account.

R	Rated uninterrupted current (Ithe) IEC 60947-1	The amperage (A) a device may conduct in continuous duty (for weeks, months, years).
	Rated insulation voltage (Ui) IEC 60947-1	The voltage (V, kV) to which insulation tests and creepage distances refer. The maximum rated operating voltage must not be higher than the rated insulation voltage.
	Rated impulse withstand voltage (Ui) IEC 60947-1	A measure for the strength of the interior of a switching device to withstand rated impulse surge voltages (kV).
	REACH – Registration, Evaluation, Authorisation and Restriction of Chemicals	An EU regulation for the registration, evaluation, authorisation and restriction of chemicals.
	Recommended color coding to EN 60 204-1	See table in glossary on pages 6-10ff.
	Reflow soldering	Reflow soldering is a soldering process for SMT components. A solder paste placed onto the printed circuit board or conductive film is molten by heat (infrared, vapour phase, laser or radiant heater) and subsequently hardened by cooling down to form a rigid connection with the component.
	Resistance to climatic conditions	Maximum admissible temperature and humidity range.
	RF 15	RAFI short-travel keyswitch series of square design with an edge length of 15 mm provided with gold or silver contacts and many different integrated illumination options.
	RF 19	RAFI short-travel keyswitch series of square design with an edge length of 19 mm provided with gold or silver contacts and many different integrated illumination options.
	RG 85 III	A modular short-travel system for elevator control, info terminals, vending machines, etc. The RG 85 III product series comprises pushbuttons, signal indicators and keylock switches.
	RK90	Standard keycap system for use with RAFI short-travel keyswitches.
	RoHS – Restriction of Hazardous Substances	An EU regulation for the restriction of the use of certain materials in electrical and electronic devices.
	Rotary switch	A rotary switch is a special panel mounting pushbutton used for setting logical states by mechanical rotation. Different logical states are realized with specific rotating angles assigned.
	RS 74	RAFI full-travel keyswitch series with an operating travel of 2.5 mm.
RS 76	RAFI full-travel keyswitch series with an operating travel of 4 mm.	
S	Screw terminal	A static contact for connecting a wire (with a screw) to integrate components into circuits.
	Selector switch	Actuators used for selecting a certain condition. Selector switches are operated by turning and offer an unambiguous switching position indication.
	Selector switch with long handle	A selector switch with a larger handle which is used, for example, if operation is necessary wearing gloves.
	Short-travel keyswitch	An electromechanical keyswitch with a maximum travel of 1 mm providing a distinct tactile feedback for the complete operating behaviour.
	Shock resistance	Describes the ability of a switching device to withstand pulse-like impact movements without effect on the operating status and without suffering mechanical damage.
	Signal indicator	Colored indicating element for visual indication of machine states on control components.
	Signal lamps	Components indicating process states on machines by means of a visual signal.

GLOSSARY

ELECTROMECHANICAL COMPONENTS

	Silver contacts (Ag contacts)	Silver or silver/nickel alloy contacts are usually used for switching power levels ≥ 1 W and voltages ≥ 12 V.
	Single-handed assembly	The actuator inserted at assembly is kept in the panel cut-out by the cast-on seal. This makes it possible to pre-install all actuators from the front, even if minor vibrations occur. Subsequently you can complete mounting by tightening the ring nut without having to hold the components with your hand.
	SMT (Surface Mounted Technology)	SMT devices are provided with a soldering contact pad. They are soldered directly onto the surface of a printed circuit board.
	Solder heat resistance	Definition of the maximum admissible soldering time and temperature when soldering components with solder terminals. THT: IEC 600 68-2-2; SMT: IEC 600 68-2-58
	Solder terminals (etc.) IEC 61058-1	Contact points on a component used for connection to a printed circuit board by soldering.
	Spacer	Used to obtain a defined distance between the front panel and the printed circuit board (e.g. 9.2 mm – Front panel thickness = Spacer height).
S	Spark distance EN IEC 60947-1, EN IEC 61058-1	The shortest distance (mm) in air between two conductive parts.
	Special sealing	A special wear-resistant seal used in some pushbuttons.
	Standard	A rule with a generally accepted binding nature.
	Storage temperature	Admissible temperature range (°C) for storing a device.
	Switch	This term is often used as a generic term for electrical switching components. In contrast with pushbuttons, switches latch when operated once. To unlatch them, they must be operated again.
	Switching capacity	A parameter specifying the rated operating currents (I_e) as a function of the rated operating voltage (U_e).
	Switching contact	The purpose of switching contacts is to switch on circuits, conduct currents, switch off circuits and ensure insulation when circuits are open.
	Switching device	General term used for single components for opening or closing circuits.
		Tactility
	Terminals	Specifies the way a switch is connected to a circuit or device to switch. Available types are screw terminals, solder terminals, PCB mounting pins, stranded wires, wire-wrap terminals, and a large selection of male and female connectors. Terminals are static contacts for connecting RAFI components with wires, conductor tracks, etc. Static contacts can be designed as removable contacts (screw, quick-connect, cage clamp terminals, etc.) or permanent contacts (solder, welding contacts, etc.).
	Tightening torque (Nm)	A measure for the torsional effect of a force (N) acting on a rotary object.
	Toggle switch	Actuator indicating the switching status by the lever position.
T	Tool	An auxiliary item used for assembly.
	Tolerances	Our specifications sometimes contain information on tolerances. Any tolerances that are not specified are in conformance with DIN ISO 2768 m-k.
	THT (Through Hole Technology)	Through hole technology involves inserting the components through the PCB holes and joining them with special THT soldering processes (wave soldering, manual soldering).
	Torque (Nm)	A measure for the force (N) acting on a rotary object.
	Translucent	Light-permeable material structure for diffuse (sometimes colored) illumination of a large area.
	Transparent	Light-permeable material structure, sometimes with color mixed in, used for example in lenses.
		Twin pushbutton

U	UL	Underwriters Laboratories (US approval organisation).
	Units of measurement	All dimensions in this catalogue are given in mm. For conversion tables for various units of measurement, see glossary on pages 6-13.
	Usage categories to IEC 60947-5-1 [120 – 230 V]:	<p>Alternating current [AC]:</p> <p>AC-12 Control of resistive loads and solid-state loads with isolation by optocouplers</p> <p>AC-13 Control of solid-state loads with transformer isolation</p> <p>AC-14 Control of small electromagnetic loads (< 72 VA)</p> <p>AC-15 Control of electromagnetic loads (> 72 VA)</p> <p>Direct current [DC]:</p> <p>DC-12 Control of resistive loads and solid-state loads with isolation by optocouplers</p> <p>DC-13 Control of electromagnetic loads</p> <p>DC-14 Control of electromagnetic loads having economy resistors in circuit</p>
V	VDE	Verband Deutscher Elektrotechniker (VDE) – Association for Electrical, Electronic and Information Technologies (German approval organisation).
W	Wave soldering	Process for lead-free and lead-involving soldering standardised in E DIN EN 60068-2-20.

GLOSSARY

ELECTROMECHANICAL COMPONENTS

Recommended color coding acc. to EN 60 204-1 (see also IEC 600 73 color coding)

1. Colors

Pushbutton actuators must be marked with colors in accordance with table 1.

Colors for START/ON actuators should be WHITE, GREY or BLACK, preferably WHITE. GREEN is also permitted. RED must not be used.

RED must be used for actuators provided for stopping in an emergency situation and for switching off in an emergency situation. Colors for STOP/OFF actuators should be BLACK, GREY or WHITE, preferably BLACK. GREEN must not be used. RED is also permitted, however, it is recommended to avoid RED in the vicinity of components provided for emergency actions.

WHITE, GREY or BLACK are the preferred colors for pushbutton actuators with alternating START/ON and STOP/OFF function. RED, YELLOW or GREEN must not be used.

WHITE, GREY or BLACK are the preferred colors for pushbutton actuators initiating a function while being pressed and stopping the function when released (e.g. inching operations). RED, YELLOW or GREEN must not be used.

Resetting pushbuttons must be BLUE, WHITE, GREY or BLACK. In those cases where they also perform a STOP/OFF function, the preferred colors are WHITE, GREY or BLACK, with BLACK being the first choice. GREEN must not be used.

Table 1: Colors for pushbutton actuators and their meanings

COLOR	MEANING	DESCRIPTION	EXAMPLES OF APPLICATION
RED	Emergency situation	Actuate in a dangerous or emergency situation	Emergency stop. Initiate emergency functions
YELLOW	Abnormal condition	Actuate if an abnormal condition occurs	Intervention to suppress an abnormal condition. Intervention to resume an interrupted automatic sequence
GREEN	Normal condition	Actuate to initiate normal conditions	START/ON
BLUE	Mandatory action	Actuate in a situation which requires a mandatory action	Resetting function
WHITE	No special meaning defined	General initiation of functions except emergency stop (see note below)	START/ON (preferred) STOP/OFF
GREY			START/ON STOP/OFF
BLACK			START/ON STOP/OFF (preferred)

NOTE: If an additional coding feature (e.g. shape, position, surface finish) is used for marking pushbutton actuators, the same colors – WHITE, GREY or BLACK – may also be used to identify different functions (e.g. WHITE for START/ON and STOP/OFF actuators).

Recommended color coding acc. to EN 60 204-1

2. Symbolic marking

It is recommended to mark pushbuttons with the following symbols near the actuator or – preferably –

directly on the actuator in addition to the functional identification described:

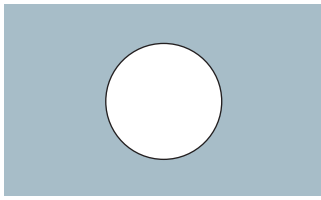
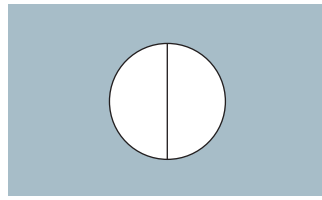
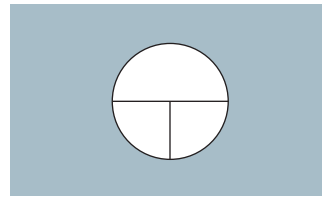
START or ON	STOP or OFF	Pushbuttons with alternating START/STOP and ON/OFF function	Pushbuttons with START or ON function while being pressed and with STOP or OFF function when being released (i.e. inching).
60417-IEC-5007	60417-IEC-5008	60417-IEC-5010	60417-IEC-5011
			

3. Indicator lights and indicators

Applications

Indicator lights and indicators are used to provide the following information:

- Indication: To draw the operator's attention to a specific circumstance or to indicate that a specific action should be performed. The usual colors used for this type of application are RED, YELLOW, GREEN or BLUE.
- Confirmation: To confirm a command or condition, or to confirm the end of a change operation or transition time. Usually, BLUE and WHITE are used for this type of application; GREEN is permitted in some cases.

Colors

Indicator lights must have the color coding according to table 3 unless otherwise agreed between the supplier and the purchaser. Other meanings deviating therefrom (refer to IEC 60073) may be assigned based on one of the following criteria:

- Safety of persons and environment
- Condition of the electrical equipment

Table 2: Colors of indicator lights and their meanings relating to the machine status

COLOR	MEANING	DESCRIPTION	OPERATOR ACTION
RED	Emergency situation	Dangerous condition	Immediate action to respond to a dangerous condition (e.g. by pressing emergency stop)
YELLOW	Abnormal condition	Abnormal condition; anticipated critical condition	Monitoring and/or intervention (e.g. by restoring the intended function)
GREEN	Normal condition	Normal condition	Optional
BLUE	Mandatory action	Indication of a condition requiring operator intervention	Mandatory action
WHITE	Neutral	Other conditions; may be used if there is uncertainty about the appropriateness of RED, YELLOW, GREEN or BLUE	Monitor

GLOSSARY

ELECTROMECHANICAL COMPONENTS

CE conformity

The CE conformity information for the individual products is specified in the general information section of each chapter. With regard to CE conformity, the products listed in this catalogue can be subdivided into the following groups based on the Low-Voltage Directive 73/23/EEC:

Emergency stop components with an operating voltage > 50V

For example, RAFIX 16, 22 QR. These products are subject to the Low-Voltage Directive 73/23/EEC and the Machinery Directive 89/392/EEC.

Emergency stop components with an operating voltage < 50V

For example, LUMOTAST 25 and RAFIX 16 with gold contacts. These products are subject to the Machinery Directive 89/392/EEC.

All other products with an operating voltage > 50V

For example, LUMOTAST 75 pushbuttons, signal lamps. These products are subject to the Low-Voltage Directive 73/23/EEC.

All other products with an operating voltage < 50V

For example, RACON, LUMOTAST 25, signal lamps with LED. These products are not subject to any European directive.

Single parts, accessories and luminous elements

These products are not subject to any European directive.

Flammability rating to UL 94

Flammability

The flammability class specifications refer only to insulating materials which are in direct contact with

electrically conductive parts. The flammability of the material with the lowest rating is specified.

Flammability class acc. to		Self-extinguishing after . . . seconds in vertical burning test	Possibility of dripping material igniting other objects	Maximum smoldering time
UL	IEC/VDE			
V 0	FV 0	Less than 5 seconds	No	30 seconds
V 1	FV 1	Less than 25 seconds	No	30 seconds
V 2	FV 2	Less than 25 seconds	Possible	60 seconds
HB	FH	Burn rate (horizontal burning test with the following values): Wall thickness up to 3 mm = 3 inches/minute, max.; wall thickness over 3 mm = 1.5 inches/minute, max.		

Units of measurement

All the dimensions in the dimensional drawings in this catalogue are given in mm. All temperature values are given in degrees Celsius. A conversion table for the most common units of measurement is provided below for your convenience:

Conversion table:

mm	x 0.0394	= inches
grams	x 0.0353	= ounces
Newton	x 0.224	= pounds
Newton	x 3.59	= ounces
°Celsius	x 1.8 + 32	= °Fahrenheit

Contact block identification data

Example: RAFIX 22 QR 1.20.124.xxx/5.00.100.1xx

Rated values to IEC 61058-1

10/100(6)[3.6] 250 ~ 7,5 (4) 400 ~ 5E4 25T70

Explanation of data from left to right, current-related data first

10 or 7,5

10 A ohmic load at 250 V, 7,5 A ohmic load at 400 V

100

100 A capacitive peak input current (tested at 250 V)
(descending E-function to rated current)

(6) or (4)

6 A motor rated current at 250 V, 4 A motor rated current at 400 V. The test specimen makes 6 times the motor rated current, 36 A or 24 A, $\cos \phi = 0.6$, $\triangleq 9000$ or 9600 VA throughout the full durability test.

[3.6]

3.6 A filament lamp rated current = 36 A peak input current (tested at 250 V)

250 AC or 400 AC

Rated voltages and mains type, \cong AC

5E4

50,000 operations (no. of test cycles) $\triangleq 5 \times 10^4$

25T70

-25°C lower operating temperature and +70°C upper operating temperature

The first 25,000 operations were tested at +70°C, the remaining 25,000 operations at -25°C in all of the tests.

Rated values to IEC 60947-5-1

U 400 V AC12 10 A, AC 15 6 A/250 V
DC13 Q 300

U 400 V

Rated insulation voltage for use in devices designed for continuous duty and degree of contamination 3

AC12 10 A

10 A ohmic load and semiconductor load

AC15 6 A/250 V

Controlling electromagnetic loads

Max. 60 A $\cos \phi = 0.3$ at 250 V AC make,
6 A $\cos \phi = 0.3$ at 250 V AC break

DC13 Q 300

Controlling solenoids (DC)

Maximum thermal continuous current 2.5 A

Max. 0.55 A at 120 V – make and break

Max. 0.27 A at 250 V – make and break

CURus ratings

A 600, 10 A/250 Vac

A 600

Thermal continuous test current 10 A

Max. permitted load in VA:

Max. 7,200 VA make, 720 VA break

Max. make values:

60 A/120 V

30 A/240 V

15 A/480 V

12 A/600 V

Max. break values:

6 A/120 V

3 A/240 V

1.5 A/480 V

1.2 A/600 V

10 A/250 Vac

Ohmic AC load

GLOSSARY

ELECTROMECHANICAL COMPONENTS

International Protection (IP) degrees of protection

Three different standards are used to classify protection against contact and impermeability of products in industrial applications.

In addition to the American NEMA Code, the degree of protection for products and devices is indicated worldwide using the IP Code (as defined in ISO 20653 or DIN EN 60529). The IP Code is also accepted in the countries of North America and has prevailed worldwide over the NEMA standard despite the lack of correlation.

In the IP Code, the specified degree of protection refers to the part of the device located on the front panel (of a housing). In RAFI components, the electrical terminals are located behind







the front panel and are thus not subject to any special protection requirements unless they are provided with special protection means such as cable sleeves, insulating sleeves or similar elements during assembly.

ISO 20653, "Road vehicles; degrees of protection (IP Code); protection against ingress of foreign objects, water and contact"; and DIN EN 60529, "Degrees of protection provided by enclosures (IP Code)", are both applicable and differ only slightly.

The IP Code consists of two digits.

The 1st digit relates to protection against contact and ingress of foreign objects.

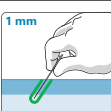
1st digit

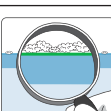
ISO 20653 Digit	DIN EN 60529 Digit		Protection against contact	Protection against ingress of foreign objects
0	0		No protection	No protection
1	1		Protected against contact with the back of the hand	Protected against solid foreign objects (diameter 50 mm and greater)
2	2		Protected against contact with a finger	Protected against solid foreign objects (diameter 12.0 mm and greater)
3	3		Protected against contact with a tool	Protected against solid foreign objects (diameter 2.5 mm and greater)
4	4		Protected against contact with a wire	Protected against solid foreign objects (diameter 1.0 mm and greater)
5K	5		Protected against contact with a wire	Dust-protected
6K	6		Protected against contact with a wire	Dust-proof

The 2nd digit relates to protection against ingress of water.

The values increase sequentially in the range from IPx0 to IPx6. In other words, during a qualification test, the lower code values for a given degree of protection are also deemed to have passed. (Example: IPx4 tested: IPx3, IPx2, IPx1, IPx0 also passed.)
For the IPx7, IPx8 and IPx9K degree of protection definitions,



fundamentally different conditions apply so that these values can only be specified in a restricted manner as supplementary values.

During a test of the degree of protection, only new parts are checked according to the standard definition without simulating other influences typical for the application. For testing of the second digit, only the medium of water without any additives is applicable.

Other media encountered in the various applications such as oils, bases and water with additives might need to be tested separately in some cases. According to ISO 20653, the test is deemed to be passed if adequate separation from hazardous parts is maintained during testing with an access probe (digit 1) or if any water that might have penetrated does not damage the functioning and insulation of the product (digit 2).

In addition to selective determination of the mechanical and electrical characteristics of products under diverse environmental conditions, the RAFI test laboratory can also perform complete qualification testing. Thanks to the company's many years of experience and its expertise, RAFI can thus provide verified characteristics for the performance of its products.

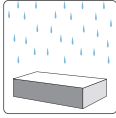
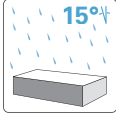
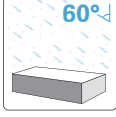
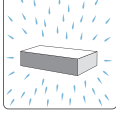
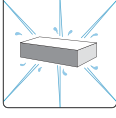
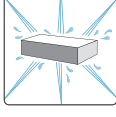
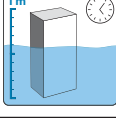
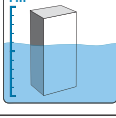
2nd digit

ISO 20653	DIN EN 60529		Logic	Protection against ingress of water
Digit	Digit			
0	0		Increasing	No protection
1	1		Increasing	Protection against dripping water, vertical
2	2		Increasing	Protection against dripping water if housing is inclined by up to 15°
3	3		Increasing	Protection against spray water up to 60° relative to vertical line
4	4		Increasing	Protection against splashing water from all sides
5	5		Increasing	Protection against water jets from any angle
6	6		Increasing	Protection against powerful water jets
7	7		Supplementary	Protection against temporary submersion
8	8		Supplementary	Protection against continuous submersion
9K			Supplementary	Protection against ingress of water during high-pressure/steam-jet cleaning, specifically for road vehicles

LUMOTAST, RAFIX 16, RAFIX 22 FS⁺, RAFIX 22 QR

Betriebsanleitung Not-Halt-Befehlsgeräte (Original)

Operating Instructions EMERGENCY STOP Control Units (Translation of the source text)

Mode d'emploi auxiliaires de commande d'ARRÊT D'URGENCE (Traduction original)

D 1. Sicherheitshinweise

- ▲ - Vor Inbetriebnahme bitte Betriebsanleitung sorgfältig lesen.
- ▲ - Not-Halt-Befehlsgeräte erfüllen eine Personenschutzfunktion. Unsachgemäßer Einbau, sachwidrige Anwendung oder Manipulationen können zu schweren Verletzungen von Personen führen!
- ▲ - Not-Halt-Befehlsgeräte dürfen nicht umgangen, entfernt oder auf andere Weise unwirksam gemacht werden!
- ▲ - Vor Beginn der Installation Anlage und Gerät spannungsfrei schalten!
- ▲ - Vor Erstinbetriebnahme der Maschine oder Anlage Not-Halt-Befehlsgerät durch Testbetätigung auf korrekte Montage und Funktion überprüfen.
- ▲ - Not-Halt-Befehlsgeräte mit sichtbaren Beschädigungen sind unverzüglich auszutauschen.
- ▲ - Not-Halt-Funktion darf nicht als Ersatz für Schutzmaßnahmen oder andere Sicherheitsfunktionen verwendet werden.
- ▲ - Not-Halt-Funktion darf die Wirksamkeit von Schutzeinrichtungen oder von Einrichtungen mit anderen Sicherheitsfunktionen nicht beeinträchtigen.

GB 1. Safety instructions

- Please read the operating instructions carefully prior to use.
- EMERGENCY STOP control units are designed to protect persons. Inappropriate installation, improper use or inadmissible manipulation may result in severe injuries!
- EMERGENCY STOP control units must never be bypassed, removed or disabled in any other way!
- Disconnect the power supply to the machinery and device prior to installation!
- Operate the EMERGENCY STOP control unit to test and verify proper installation and function prior to initial start-up of the machine or line.
- An EMERGENCY STOP control unit with an obvious defect must be replaced immediately.

F 1. Consignes de sécurité

- Il faut soigneusement lire le mode d'emploi avant la mise en service.
- Les auxiliaires de commande d'ARRÊT D'URGENCE remplissent une fonction de protection personnelle. Un montage inapproprié, une application contre-indiquée ou une manipulation peuvent causer des blessures corporelles graves !
- Il est interdit de ponter, d'enlever ou de rendre inopérants les auxiliaires de commande d'ARRÊT D'URGENCE !
- Avant d'entamer l'installation il faut mettre l'installation et l'appareil hors tension !
- Avant la première mise en service de la machine ou de l'installation, contrôler l'auxiliaire de commande d'ARRÊT D'URGENCE quant au montage et à un fonctionnement corrects.
- Les auxiliaires de commande d'ARRÊT D'URGENCE présentant des dommages visibles sont à remplacer sans tarder.

D 2. Allgemeine Beschreibung und bestimmungsgemäße Verwendung

Not-Halt-Befehlsgeräte sind elektromechanische Schaltgeräte zum Schutz von Personen. Sie dienen der schnellen Abschaltung um Maschinen, Fahrzeuge und Anlagen in einen sicheren Zustand zu bringen, um Gefahren und Schäden für Mensch und Maschine zu vermeiden oder zu verringern.

Für die Inbetriebnahme, den Einsatz und technischen Überprüfungen gelten im speziellen folgende Vorschriften:

- Die Maschinenrichtlinie 2006/42/EG
- Die Sicherheitsvorschriften sowie
- Die Unfallverhütungsvorschriften/Sicherheitsregeln

Hersteller und Benutzer von Maschinen, an denen Not-Halt-Befehlsgeräte eingesetzt werden, tragen die Verantwortung für die Beachtung der Betriebsanleitung, wie auch für die Einhaltung der für sie geltenden Sicherheitsvorschriften und -regeln.

Für den Einbau und Betrieb von Not-Halt-Befehlsgeräten müssen zur bestimmungsgemäßen Verwendung folgende Anforderungen beachtet werden:

- EN 60947-5-1:2010 - EN ISO 13849-2:2008
- EN 60947-5-5:2010 - EN ISO 13850:2008
- EN ISO 13849-1:2008

GB 2. General description and intended use

EMERGENCY STOP control units are electromechanical switching devices designed to protect persons. They are used for instant disconnection to achieve a safe status of machines, vehicles or other equipment in order to avoid or reduce risks or damage to man and machine. The following standards and regulations apply to their start-up, use and technical inspections, without limitation:

- Machinery Directive 2006/42/EC
- Safety standards
- Accident prevention regulations / rules for safety

Manufacturers and users of machines provided with EMERGENCY STOP control units are responsible for ensuring that the operating instructions are observed and the applicable safety standards and rules complied with.

The following standards govern installation and operation of EMERGENCY STOP control units in accordance with their intended use:

- EN 60947-5-1:2010
- EN 60947-5-5:2010 - EN ISO 13849-2:2008
- EN ISO 13849-1:2008 - EN ISO 13850:2008

F 2. Description générale et application conforme aux prescriptions

Les auxiliaires de commande d'ARRÊT D'URGENCE sont des appareils de commutation électromécaniques pour protéger des personnes. Ils servent à couper rapidement les machines, les véhicules et les installations, à les amener dans un état de sécurité fiable pour éviter ou diminuer les risques de dommages corporels et de dégâts matériels.

Pour la mise en service, l'utilisation et les contrôles techniques, il faut respecter les prescriptions suivantes:

- La directive sur les machines selon la norme 2006/42/EG
 - Les règlements de sécurité ainsi que
 - Les instructions sur la prévention des accidents / règlements de sécurité
- C'est aux fabricants et utilisateurs de machines où des auxiliaires de commande d'ARRÊT D'URGENCE sont utilisés, qu'incombe la responsabilité du respect du mode d'emploi ainsi que des prescriptions et règlements de sécurité en vigueur.
- Pour le montage et l'exploitation des auxiliaires de commande d'ARRÊT D'URGENCE, il faut respecter les exigences suivantes pour garantir une utilisation conforme aux dispositions :
- EN 60947-5-1:2010 - EN ISO 13849-2:2008
 - EN 60947-5-5:2010 - EN ISO 13850:2008
 - EN ISO 13849-1:2008

D 3. Produktbeschreibung

Aufbau: Die Not-Halt-Befehlsgeräte bestehen aus einer Kombination von Betätigern mit einem oder mehreren Schaltelementen. Die Not-Halt-Befehlsgeräte gibt es als Einbauversion oder in einem Gehäuse verbaut.

Die Betätigung erfolgt durch Drücken, die Entriegelung erfolgt je nach Variante entweder durch:

- Drehbewegung in beide Richtungen nach links oder nach rechts
- Ziehen entgegen der Betätigungsrichtung

GB 3. Product description

Design: An EMERGENCY STOP button is an assembly of actuator combined with one or more contact blocks. EMERGENCY STOP buttons are available either as a panel mounting version or installed in a separate housing.

They are operated by pressing. Unlatching is done by one of two methods:

- Turning in either direction
- Pulling against the direction of operation

F 3. Description de produit

Structure: Les boutons-poussoirs d'ARRÊT D'URGENCE sont composés d'une combinaison d'actionneurs ou de plusieurs éléments de commutation. Les boutons-poussoirs d'ARRÊT D'URGENCE sont disponibles en version intégrable ou installés dans un boîtier.

L'actionnement s'effectue par appui sur ces derniers. Selon la variante, le déverrouillage s'effectue soit par:

- Un mouvement de rotation dans les deux directions, soit vers la gauche, soit à droite
- Soit en tirant dans la direction opposée de la direction d'actionnement

Produkt Product Produit	Einbau Ø mm Mounting Ø mm Montage Ø mm	Betätiger Actuator Actionneur	Schaltelement Contact block Élément de commutation
LUMOTAST 22	Ø 22,3	1.15.105.001/0000 1.15.105.011/0000 1.15.105.021/0000 1.15.105.031/0000	integriert / incl.
LUMOTAST 25	Ø 16,2	1.15.154.006/0301 1.15.154.016/0301	integriert / incl.
RAFIX 16	Ø 16,2	1.30.074.821/0000 1.30.074.281/0300 1.30.074.501/0304 1.30.074.101/0301 1.30.074.521/0304 1.30.074.121/0301	1.20.123.xxx 1.20.130.0xx
RAFIX 16 F	□23,1 Ø 22,3	1.30.094.001/0300 1.30.094.011/0300	
RAFIX 22 QR	Ø 22,3	1.30.243.501/0300 1.30.243.601/0300 1.30.243.701/0300 1.30.243.702/0300 1.30.243.703/0300 1.30.243.001/0300 1.30.243.901/0300	5.00.100.xxx 1.20.124.xxx 1.20.125.xxx 1.20.128.xxx 1.20.129.0xx
RAFIX 22 FS ⁺	Ø 22,3	1.30.273.001/0000 1.30.273.001/2200 1.30.273.001/2300 1.30.273.101/0000 1.30.273.101/2200 1.30.273.101/2300 1.30.273.501/0300 1.30.273.502/0300 1.30.273.601/0300 1.30.273.602/0300	1.20.126.4xx 1.20.126.5xx 1.20.126.6xx 1.20.126.7xx
E-Box	Ø 22,3	1.20.810.306/0000 1.20.810.350/0000 1.20.810.390/0000	integriert / incl.

D **Tabelle 3.1** Weitere technische Daten sind dem Katalog zu entnehmen.

GB **Table 3.1** For additional technical data, please refer to the catalogue.

F **Tableau 3.1** Pour les autres caractéristiques techniques, voir catalogue.

4. **D** Montage **GB** Assembly **F** Montage

**LUMOTAST 25/
LUMOTAST 22**



RAFIX 16 / RAFIX 16 F

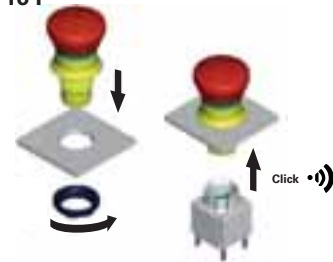

RAFIX 22 FS+ / E-Box

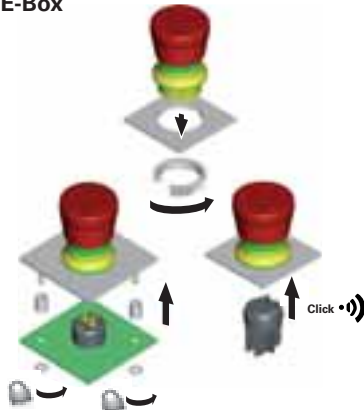

RAFIX 22 QR

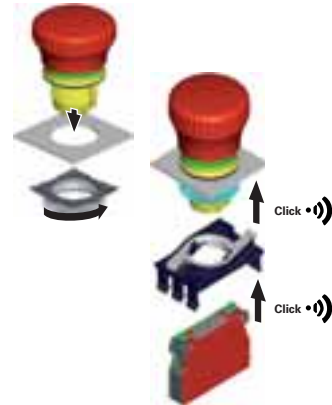

5. **D** Betrieb **GB** Operation **F** Mise en service



D 6. **Wartung und Instandsetzung**

Es wird empfohlen, das Not-Halt-Befehlsgerät regelmäßig, mindestens aber ein Mal pro Jahr von einer autorisierten Person zu Testzwecken auszulösen und auf ordnungsgemäße Funktion zu überprüfen, regelmäßig auf sichtbare Beschädigungen zu untersuchen und gegebenenfalls sofort auszutauschen.

GB 6. **Maintenance and repair**

It is recommended to have the EMERGENCY STOP control unit tripped for testing and verified for proper function by an authorised person on a regular basis, however, at least once a year. Inspect it regularly for obvious damage and replace it immediately if necessary.

F 6. **Entretien et réparation**

Il est recommandé d'enclencher de temps en temps l'auxiliaire de commande d'ARRÊT D'URGENCE pour le tester et de le faire contrôler régulièrement, au moins une fois par an, par une personne autorisée. Il faut contrôler régulièrement s'il n'y a pas d'endommagements visibles et si nécessaire les remplacer tout de suite.

D **EG-Konformitätserklärung**

Aussteller Name/Anschrift: RAFI GmbH & Co. KG, 88276 Berg, Ravensburger Str. 128-134
 Bevollmächteter: T. Beil, RAFI GmbH, 88276 Berg, Ravensburger Str. 128-134
 Produktbezeichnung: Not-Halt-Befehlsgerät
 Typbezeichnung: siehe Tab. 3.1
 Die bezeichneten Geräte erfüllen folgende Richtlinien:

GB **EC Statement of Conformity**

Issuer name/address: RAFI GmbH & Co. KG, D-88276 Berg, Ravensburger Str. 128-134
 Authorized person: T. Beil, RAFI GmbH, D-88276 Berg, Ravensburger Str. 128-134
 Product designation: EMERGENCY STOP control unit
 Type designation: see table 3.1

The devices referred to comply with the following Directives:

F **Déclarations de conformité CE**

Nom/adresse du délivreur: RAFI GmbH & Co. KG, D-88276 Berg, Ravensburger Str. 128-134
 Mandataire: T. Beil, RAFI GmbH, D-88276 Berg, Ravensburger Str. 128-134
 Désignation du produit: Auxiliaire de commande ARRÊT D'URGENCE
 Désignation du type: voir tab. 3.1
 Les appareils désignés répondent aux exigences des directives suivantes:

Richtlinie Directive Directive	vom dated du	angewandte Norm standard applied norme harmonisée	für valid for pour
2006/95/EG	12.12.2006	DIN EN 60947-5-1:2010 DIN EN 60947-5-5:2005	Schaltelemente, Betätiger Contact blocks, actuators Éléments de commutation, actionneurs
2006/42/EG	17.05.2006	DIN EN 60947-5-5:2005 DIN ISO 13850:2008	Schaltelement, Betätiger Contact blocks, actuators Éléments de commutation, actionneurs

Berg, 03.12.2010

RAFI GmbH & Co. KG

Ravensburger Str. 128-134, D-88276 Berg/Ravensburg
 Phone: +49 751 89-0, Fax: +49 751 89-13 00
 www.rafi.de, info@rafi.de

APPENDIX

REFERENCE NUMBER GUIDE

Order number	Page	Order number	Page	Order number	Page	Order number	Page
1.01.102.001/0104	1 - 84	1.14.001.916/0000	4 - 44	1.15.108.632/0100	1 - 44	1.20.122.163/0000	2 - 69
1.01.102.001/0301	1 - 84	1.14.001.920/0000	4 - 44	1.15.108.661/0100	1 - 44	1.20.122.171/0000	2 - 64
1.01.102.001/0507	1 - 84	1.14.002.001/0000	4 - 8	1.15.108.851/0000	1 - 43	1.20.122.172/0000	2 - 64
1.01.102.011/0104	1 - 84	1.14.002.003/0000	4 - 8	1.15.108.852/0000	1 - 44	1.20.122.173/0000	2 - 64
1.01.102.011/0205	1 - 84	1.14.002.006/0000	4 - 9	1.15.108.911/0000	1 - 44	1.20.123.001/0000	2 - 70
1.01.102.011/0301	1 - 84	1.14.002.011/0000	4 - 8	1.15.108.912/0000	1 - 44	1.20.123.003/0000	2 - 70
1.01.102.011/0507	1 - 84	1.14.002.016/0000	4 - 9	1.15.108.941/0000	1 - 43	1.20.123.004/0000	2 - 70
1.02.157.201/1000	3 - 12	1.14.002.101/0000	4 - 8	1.15.108.976/0000	1 - 54	1.20.123.005/0000	2 - 70
1.02.157.201/1300	3 - 12	1.14.002.103/0000	4 - 8	1.15.108.977/0000	1 - 54	1.20.123.011/0000	2 - 65
1.02.157.201/1400	3 - 12	1.14.002.106/0000	4 - 9	1.15.108.981/0000	1 - 53	1.20.123.013/0000	2 - 65
1.02.157.201/1500	3 - 12	1.14.002.111/0000	4 - 8	1.15.108.982/0000	1 - 53	1.20.123.014/0000	2 - 65
1.02.157.211/1000	3 - 12	1.14.002.113/0000	4 - 9	1.15.112.101/0000	1 - 86	1.20.123.015/0000	2 - 65
1.02.157.211/1300	3 - 12	1.14.002.116/0000	4 - 9	1.15.112.121/0000	1 - 86	1.20.123.021/0000	2 - 70
1.02.157.211/1400	3 - 12	1.14.002.201/0000	4 - 8	1.15.114.906/0000	1 - 9	1.20.123.022/0000	2 - 70
1.02.157.211/1500	3 - 12	1.14.100.501/0000	4 - 37	1.15.114.936/0000	1 - 8	1.20.123.023/0000	2 - 70
1.02.614.502/1002	3 - 41	1.14.100.502/0000	4 - 37	1.15.114.966/0000	1 - 10	1.20.123.024/0000	2 - 70
1.02.614.502/1301	3 - 41	1.14.100.503/0000	4 - 38	1.15.150.506/0000	1 - 21	1.20.123.025/0000	2 - 70
1.02.614.502/1402	3 - 41	1.14.100.603/0000	4 - 38	1.15.150.556/0000	1 - 21	1.20.123.031/0000	2 - 65
1.02.614.503/1502	3 - 41	1.14.100.803/0000	4 - 38	1.15.150.606/0000	1 - 22	1.20.123.032/0000	2 - 65
1.10.001.001/0104	1 - 80	1.15.105.001/0000	1 - 88	1.15.150.656/0000	1 - 23	1.20.123.033/0000	2 - 65
1.10.001.001/0205	1 - 80	1.15.105.011/0000	1 - 88	1.15.153.106/0100	1 - 25	1.20.123.034/0000	2 - 65
1.10.001.001/0301	1 - 80	1.15.105.021/0000	1 - 88	1.15.154.006/0301	1 - 31	1.20.123.035/0000	2 - 65
1.10.001.001/0507	1 - 80	1.15.106.301/0104	1 - 78	1.15.154.016/0301	1 - 31	1.20.123.101/0000	2 - 72
1.10.001.011/0104	1 - 80	1.15.106.301/0214	1 - 78	1.15.156.001/0000	1 - 28	1.20.123.102/0000	2 - 72
1.10.001.011/0205	1 - 80	1.15.106.301/0313	1 - 78	1.15.156.011/0000	1 - 28	1.20.123.103/0000	2 - 71
1.10.001.011/0301	1 - 80	1.15.106.301/0410	1 - 78	1.20.122.001/0000	2 - 68	1.20.123.104/0000	2 - 72
1.10.001.011/0507	1 - 80	1.15.106.301/0518	1 - 78	1.20.122.002/0000	2 - 68	1.20.123.105/0000	2 - 72
1.10.001.151/0104	1 - 80	1.15.106.501/1300	1 - 78	1.20.122.003/0000	2 - 68	1.20.123.111/0000	2 - 66
1.10.001.151/0301	1 - 80	1.15.106.502/1500	1 - 78	1.20.122.011/0000	2 - 63	1.20.123.112/0000	2 - 66
1.10.001.161/0104	1 - 80	1.15.106.503/1400	1 - 78	1.20.122.012/0000	2 - 63	1.20.123.113/0000	2 - 66
1.10.001.161/0301	1 - 80	1.15.106.504/1600	1 - 78	1.20.122.013/0000	2 - 63	1.20.123.114/0000	2 - 66
1.10.102.001/0104	1 - 82	1.15.106.505/1000	1 - 78	1.20.122.021/0000	2 - 30	1.20.123.115/0000	2 - 66
1.10.102.001/0205	1 - 82	1.15.108.051/0000	1 - 41	1.20.122.021/0000	2 - 68	1.20.123.121/0000	2 - 72
1.10.102.001/0301	1 - 82	1.15.108.052/0000	1 - 41	1.20.122.022/0000	2 - 68	1.20.123.122/0000	2 - 72
1.10.102.001/0507	1 - 82	1.15.108.076/0000	1 - 55	1.20.122.023/0000	2 - 68	1.20.123.123/0000	2 - 72
1.10.102.011/0104	1 - 82	1.15.108.077/0000	1 - 56	1.20.122.031/0000	2 - 30	1.20.123.124/0000	2 - 72
1.10.102.011/0301	1 - 82	1.15.108.151/0000	1 - 41	1.20.122.031/0000	2 - 63	1.20.123.125/0000	2 - 72
1.10.107.011/0104	1 - 76	1.15.108.152/0000	1 - 41	1.20.122.032/0000	2 - 63	1.20.123.131/0000	2 - 66
1.10.107.011/0205	1 - 76	1.15.108.176/0000	1 - 56	1.20.122.033/0000	2 - 63	1.20.123.132/0000	2 - 66
1.10.107.011/0301	1 - 76	1.15.108.177/0000	1 - 56	1.20.122.041/0000	2 - 68	1.20.123.133/0000	2 - 66
1.10.107.011/0404	1 - 76	1.15.108.251/0000	1 - 39	1.20.122.042/0000	2 - 68	1.20.123.134/0000	2 - 66
1.10.107.011/0507	1 - 76	1.15.108.252/0000	1 - 40	1.20.122.051/0000	2 - 63	1.20.123.135/0000	2 - 66
1.10.118.212/0000	1 - 67	1.15.108.256/0000	1 - 40	1.20.122.052/0000	2 - 63	1.20.123.921/0000	2 - 71
1.10.118.313/0000	1 - 67	1.15.108.257/0000	1 - 40	1.20.122.061/0000	2 - 68	1.20.124.001/0000	2 - 137
1.10.118.414/0000	1 - 67	1.15.108.276/0000	1 - 54	1.20.122.062/0000	2 - 68	1.20.124.002/0000	2 - 137
1.10.118.513/0000	1 - 66	1.15.108.277/0000	1 - 54	1.20.122.101/0000	2 - 69	1.20.124.003/0000	2 - 137
1.10.118.612/0000	1 - 66	1.15.108.281/0000	1 - 55	1.20.122.102/0000	2 - 69	1.20.124.004/0000	2 - 137
1.10.118.713/0000	1 - 66	1.15.108.282/0000	1 - 55	1.20.122.103/0000	2 - 69	1.20.124.005/0000	2 - 137
1.10.118.814/0000	1 - 66	1.15.108.351/0000	1 - 39	1.20.122.111/0000	2 - 64	1.20.124.017/0000	2 - 137
1.10.119.111/0000	1 - 70	1.15.108.352/0000	1 - 40	1.20.122.112/0000	2 - 64	1.20.124.018/0000	2 - 137
1.10.119.117/0000	1 - 70	1.15.108.356/0000	1 - 40	1.20.122.113/0000	2 - 64	1.20.124.019/0000	2 - 137
1.10.119.467/0000	1 - 70	1.15.108.357/0000	1 - 40	1.20.122.121/0000	2 - 30	1.20.124.020/0000	2 - 137
1.10.119.611/0000	1 - 70	1.15.108.376/0000	1 - 54	1.20.122.121/0000	2 - 69	1.20.124.025/0000	2 - 125
1.10.119.617/0000	1 - 69	1.15.108.377/0000	1 - 54	1.20.122.122/0000	2 - 69	1.20.124.101/0000	2 - 140
1.10.119.967/0000	1 - 69	1.15.108.381/0000	1 - 55	1.20.122.123/0000	2 - 69	1.20.124.102/0000	2 - 140
1.12.000.001/0000	4 - 104	1.15.108.382/0000	1 - 55	1.20.122.131/0000	2 - 30	1.20.124.103/0000	2 - 140
1.12.000.501/0000	4 - 104	1.15.108.451/0000	1 - 39	1.20.122.131/0000	2 - 64	1.20.124.104/0000	2 - 140
1.14.001.501/0000	4 - 43	1.15.108.452/0000	1 - 39	1.20.122.132/0000	2 - 64	1.20.124.105/0000	2 - 140
1.14.001.502/0000	4 - 43	1.15.108.476/0000	1 - 53	1.20.122.133/0000	2 - 64	1.20.124.117/0000	2 - 123
1.14.001.503/0000	4 - 44	1.15.108.477/0000	1 - 54	1.20.122.141/0000	2 - 69	1.20.124.117/0000	2 - 140
1.14.001.505/0000	4 - 46	1.15.108.481/0000	1 - 53	1.20.122.142/0000	2 - 69	1.20.124.118/0000	2 - 140
1.14.001.551/0000	4 - 48	1.15.108.482/0000	1 - 53	1.20.122.143/0000	2 - 69	1.20.124.119/0000	2 - 140
1.14.001.552/0000	4 - 48	1.15.108.551/0000	1 - 39	1.20.122.151/0000	2 - 64	1.20.124.120/0000	2 - 140
1.14.001.553/0000	4 - 48	1.15.108.552/0000	1 - 39	1.20.122.152/0000	2 - 64	1.20.125.001/0000	2 - 137
1.14.001.554/0000	4 - 48	1.15.108.571/0100	1 - 44	1.20.122.153/0000	2 - 64	1.20.125.002/0000	2 - 137
1.14.001.603/0000	4 - 44	1.15.108.572/0100	1 - 44	1.20.122.161/0000	2 - 69	1.20.125.003/0000	2 - 137
1.14.001.803/0000	4 - 44	1.15.108.631/0100	1 - 44	1.20.122.162/0000	2 - 69	1.20.125.004/0000	2 - 137

Order number	Page	Order number	Page	Order number	Page	Order number	Page
1.20.125.005/0000	2 - 137	1.20.126.701/9000	2 - 257	1.30.070.201/1306	2 - 16	1.30.074.821/0000	2 - 28
1.20.125.101/0000	2 - 140	1.20.126.702/9000	2 - 257	1.30.070.201/1403	2 - 16	1.30.075.001/0104	2 - 31
1.20.125.102/0000	2 - 123	1.20.126.703/9000	2 - 257	1.30.070.201/1505	2 - 16	1.30.075.021/0104	2 - 31
1.20.125.102/0000	2 - 140	1.20.126.704/9000	2 - 257	1.30.070.201/1607	2 - 16	1.30.075.041/0104	2 - 32
1.20.125.103/0000	2 - 140	1.20.126.705/9000	2 - 257	1.30.070.251/0100	2 - 10	1.30.076.001/0000	2 - 22
1.20.125.104/0000	2 - 140	1.20.810.001/0000	2 - 78	1.30.070.251/0200	2 - 10	1.30.076.021/0000	2 - 23
1.20.125.105/0000	2 - 140	1.20.810.001/0000	5 - 19	1.30.070.251/0300	2 - 10	1.30.076.041/0000	2 - 24
1.20.125.125/0000	2 - 125	1.20.810.002/0000	2 - 78	1.30.070.251/0400	2 - 10	1.30.076.051/0000	2 - 22
1.20.126.001/0000	2 - 243	1.20.810.002/0000	5 - 19	1.30.070.251/0500	2 - 10	1.30.076.071/0000	2 - 23
1.20.126.001/9000	2 - 242	1.20.810.201/0000	2 - 79	1.30.070.251/0600	2 - 10	1.30.076.091/0000	2 - 24
1.20.126.002/0000	2 - 243	1.20.810.201/0000	2 - 148	1.30.070.271/0100	2 - 13	1.30.076.101/0000	2 - 22
1.20.126.002/9000	2 - 242	1.20.810.201/0000	5 - 20	1.30.070.271/0200	2 - 13	1.30.076.121/0000	2 - 23
1.20.126.003/0000	2 - 243	1.20.810.202/0000	2 - 79	1.30.070.271/0300	2 - 13	1.30.076.141/0000	2 - 24
1.20.126.003/9000	2 - 242	1.20.810.202/0000	2 - 119	1.30.070.271/0400	2 - 13	1.30.076.151/0000	2 - 22
1.20.126.004/0000	2 - 243	1.20.810.202/0000	2 - 148	1.30.070.271/0500	2 - 13	1.30.076.171/0000	2 - 23
1.20.126.004/9000	2 - 242	1.20.810.202/0000	5 - 20	1.30.070.271/0600	2 - 13	1.30.076.191/0000	2 - 24
1.20.126.005/0000	2 - 243	1.20.820.001/0000	2 - 78	1.30.070.301/0100	2 - 11	1.30.076.301/0000	2 - 22
1.20.126.005/9000	2 - 242	1.20.820.001/0000	5 - 19	1.30.070.301/0300	2 - 11	1.30.076.321/0000	2 - 23
1.20.126.101/9000	2 - 253	1.20.820.201/0000	2 - 79	1.30.070.321/0100	2 - 14	1.30.076.341/0000	2 - 24
1.20.126.102/9000	2 - 253	1.20.820.201/0000	2 - 148	1.30.070.321/0300	2 - 14	1.30.076.401/0000	2 - 22
1.20.126.103/9000	2 - 253	1.20.820.201/0000	5 - 20	1.30.070.451/0100	2 - 16	1.30.076.421/0000	2 - 23
1.20.126.104/9000	2 - 253	1.20.830.001/0000	2 - 78	1.30.070.451/0200	2 - 16	1.30.076.441/0000	2 - 24
1.20.126.105/9000	2 - 253	1.20.830.001/0000	5 - 19	1.30.070.451/0300	2 - 16	1.30.076.501/0000	2 - 22
1.20.126.201/0000	2 - 248	1.20.830.201/0000	2 - 79	1.30.070.451/0400	2 - 16	1.30.076.521/0000	2 - 23
1.20.126.201/9000	2 - 247	1.20.830.201/0000	2 - 148	1.30.070.451/0500	2 - 16	1.30.076.541/0000	2 - 24
1.20.126.202/0000	2 - 248	1.20.830.201/0000	5 - 20	1.30.070.451/0600	2 - 16	1.30.076.701/0000	2 - 22
1.20.126.202/9000	2 - 247	1.20.840.001/0000	2 - 78	1.30.070.501/0000	2 - 10	1.30.076.721/0000	2 - 23
1.20.126.203/0000	2 - 248	1.20.840.001/0000	5 - 19	1.30.070.521/0000	2 - 13	1.30.076.741/0000	2 - 24
1.20.126.203/9000	2 - 247	1.20.840.201/0000	2 - 79	1.30.070.551/0000	2 - 11	1.30.077.001/0000	2 - 34
1.20.126.204/0000	2 - 248	1.20.840.201/0000	2 - 148	1.30.070.571/0000	2 - 14	1.30.077.021/0000	2 - 34
1.20.126.204/9000	2 - 247	1.20.840.201/0000	5 - 20	1.30.070.601/0000	2 - 12	1.30.077.041/0000	2 - 35
1.20.126.205/0000	2 - 248	1.30.070.001/1002	2 - 10	1.30.070.621/0000	2 - 15	1.30.078.001/0100	2 - 37
1.20.126.205/9000	2 - 247	1.30.070.001/1306	2 - 10	1.30.070.701/0000	2 - 16	1.30.078.021/0100	2 - 37
1.20.126.301/9000	2 - 256	1.30.070.001/1403	2 - 10	1.30.070.801/0000	2 - 11	1.30.078.041/0100	2 - 38
1.20.126.302/9000	2 - 256	1.30.070.001/1505	2 - 10	1.30.071.021/0100	2 - 26	1.30.090.001/1000	2 - 44
1.20.126.303/9000	2 - 256	1.30.070.001/1607	2 - 10	1.30.071.021/0300	2 - 26	1.30.090.001/1300	2 - 44
1.20.126.304/9000	2 - 256	1.30.070.021/1002	2 - 13	1.30.073.500/0200	2 - 18	1.30.090.001/1400	2 - 44
1.20.126.305/9000	2 - 256	1.30.070.021/1306	2 - 13	1.30.073.501/2000	2 - 18	1.30.090.001/1500	2 - 44
1.20.126.401/0000	2 - 244	1.30.070.021/1403	2 - 13	1.30.073.501/0200	2 - 19	1.30.090.001/1600	2 - 44
1.20.126.401/9000	2 - 243	1.30.070.021/1505	2 - 13	1.30.073.521/2000	2 - 19	1.30.090.011/1000	2 - 45
1.20.126.402/0000	2 - 244	1.30.070.021/1607	2 - 13	1.30.073.540/0200	2 - 20	1.30.090.011/1300	2 - 45
1.20.126.402/9000	2 - 243	1.30.070.026/1002	2 - 13	1.30.073.541/2000	2 - 20	1.30.090.011/1400	2 - 45
1.20.126.403/0000	2 - 244	1.30.070.026/1306	2 - 13	1.30.073.550/0200	2 - 18	1.30.090.011/1500	2 - 45
1.20.126.403/9000	2 - 243	1.30.070.026/1403	2 - 13	1.30.073.551/2000	2 - 18	1.30.090.011/1600	2 - 45
1.20.126.404/0000	2 - 244	1.30.070.026/1505	2 - 13	1.30.073.570/0200	2 - 19	1.30.090.012/1000	2 - 46
1.20.126.404/9000	2 - 243	1.30.070.026/1607	2 - 13	1.30.073.571/2000	2 - 19	1.30.090.012/1300	2 - 46
1.20.126.405/0000	2 - 244	1.30.070.051/1002	2 - 11	1.30.073.590/0200	2 - 20	1.30.090.012/1400	2 - 46
1.20.126.405/9000	2 - 243	1.30.070.051/1306	2 - 11	1.30.073.591/2000	2 - 20	1.30.090.012/1500	2 - 46
1.20.126.414/0000	2 - 190	1.30.070.051/1403	2 - 11	1.30.073.600/0200	2 - 18	1.30.090.012/1600	2 - 46
1.20.126.414/0000	2 - 244	1.30.070.051/1505	2 - 11	1.30.073.601/2000	2 - 18	1.30.090.081/0000	2 - 45
1.20.126.501/9000	2 - 253	1.30.070.051/1607	2 - 11	1.30.073.620/0200	2 - 19	1.30.090.082/0000	2 - 46
1.20.126.502/9000	2 - 253	1.30.070.071/1002	2 - 14	1.30.073.621/2000	2 - 19	1.30.090.251/0100	2 - 44
1.20.126.503/9000	2 - 253	1.30.070.071/1306	2 - 14	1.30.073.640/0200	2 - 20	1.30.090.251/0200	2 - 44
1.20.126.504/9000	2 - 253	1.30.070.071/1403	2 - 14	1.30.073.641/2000	2 - 20	1.30.090.251/0300	2 - 44
1.20.126.505/9000	2 - 253	1.30.070.071/1505	2 - 14	1.30.073.650/0200	2 - 18	1.30.090.251/0400	2 - 44
1.20.126.514/0000	2 - 190	1.30.070.071/1607	2 - 14	1.30.073.651/2000	2 - 18	1.30.090.251/0500	2 - 44
1.20.126.514/0000	2 - 254	1.30.070.101/1002	2 - 12	1.30.073.670/0200	2 - 19	1.30.090.251/0600	2 - 44
1.20.126.601/0000	2 - 249	1.30.070.101/1306	2 - 12	1.30.073.671/2000	2 - 19	1.30.090.261/0100	2 - 45
1.20.126.601/9000	2 - 248	1.30.070.101/1403	2 - 12	1.30.073.690/0200	2 - 20	1.30.090.261/0200	2 - 45
1.20.126.602/0000	2 - 249	1.30.070.101/1505	2 - 12	1.30.073.691/2000	2 - 20	1.30.090.261/0300	2 - 45
1.20.126.602/9000	2 - 248	1.30.070.101/1607	2 - 12	1.30.073.700/0200	2 - 18	1.30.090.261/0400	2 - 45
1.20.126.603/0000	2 - 249	1.30.070.121/1002	2 - 15	1.30.073.701/2000	2 - 18	1.30.090.261/0500	2 - 45
1.20.126.603/9000	2 - 248	1.30.070.121/1306	2 - 15	1.30.073.720/0200	2 - 19	1.30.090.261/0600	2 - 45
1.20.126.604/0000	2 - 249	1.30.070.121/1403	2 - 15	1.30.073.721/2000	2 - 19	1.30.090.262/0100	2 - 46
1.20.126.604/9000	2 - 248	1.30.070.121/1505	2 - 15	1.30.073.740/0200	2 - 20	1.30.090.262/0200	2 - 46
1.20.126.605/0000	2 - 249	1.30.070.121/1607	2 - 15	1.30.073.741/2000	2 - 20	1.30.090.262/0300	2 - 46
1.20.126.605/9000	2 - 248	1.30.070.201/1002	2 - 16	1.30.074.281/0300	2 - 29	1.30.090.262/0400	2 - 46

APPENDIX

REFERENCE NUMBER GUIDE

Order number	Page	Order number	Page	Order number	Page	Order number	Page
1.30.090.262/0500	2 - 46	1.30.240.001/1601	2 - 92	1.30.240.055/1501	2 - 100	1.30.240.105/0508	2 - 99
1.30.090.262/0600	2 - 46	1.30.240.001/1607	2 - 92	1.30.240.055/1508	2 - 100	1.30.240.105/0601	2 - 99
1.30.090.501/0000	2 - 44	1.30.240.001/1608	2 - 92	1.30.240.055/1601	2 - 100	1.30.240.105/0608	2 - 99
1.30.090.511/0000	2 - 45	1.30.240.005/1001	2 - 99	1.30.240.055/1608	2 - 100	1.30.240.105/0701	2 - 99
1.30.093.500/0200	2 - 48	1.30.240.005/1008	2 - 99	1.30.240.061/1001	2 - 95	1.30.240.105/0708	2 - 99
1.30.093.501/2000	2 - 48	1.30.240.005/1301	2 - 99	1.30.240.061/1003	2 - 95	1.30.240.111/0101	2 - 92
1.30.093.510/0200	2 - 49	1.30.240.005/1308	2 - 99	1.30.240.061/1004	2 - 95	1.30.240.111/0107	2 - 92
1.30.093.511/2000	2 - 49	1.30.240.005/1401	2 - 99	1.30.240.061/1005	2 - 95	1.30.240.111/0108	2 - 92
1.30.093.520/0200	2 - 50	1.30.240.005/1408	2 - 99	1.30.240.061/1006	2 - 95	1.30.240.111/0201	2 - 92
1.30.093.521/2000	2 - 50	1.30.240.005/1501	2 - 99	1.30.240.061/1007	2 - 95	1.30.240.111/0203	2 - 92
1.30.093.550/0200	2 - 48	1.30.240.005/1508	2 - 99	1.30.240.061/1008	2 - 95	1.30.240.111/0204	2 - 92
1.30.093.551/2000	2 - 48	1.30.240.005/1601	2 - 99	1.30.240.061/1301	2 - 95	1.30.240.111/0205	2 - 92
1.30.093.560/0200	2 - 49	1.30.240.005/1608	2 - 99	1.30.240.061/1307	2 - 95	1.30.240.111/0206	2 - 92
1.30.093.561/2000	2 - 49	1.30.240.011/1001	2 - 92	1.30.240.061/1308	2 - 95	1.30.240.111/0207	2 - 92
1.30.093.570/0200	2 - 50	1.30.240.011/1003	2 - 92	1.30.240.061/1401	2 - 95	1.30.240.111/0208	2 - 92
1.30.093.571/2000	2 - 50	1.30.240.011/1004	2 - 92	1.30.240.061/1407	2 - 95	1.30.240.111/0301	2 - 92
1.30.093.600/0200	2 - 48	1.30.240.011/1005	2 - 92	1.30.240.061/1408	2 - 95	1.30.240.111/0307	2 - 92
1.30.093.601/2000	2 - 48	1.30.240.011/1006	2 - 92	1.30.240.061/1501	2 - 95	1.30.240.111/0308	2 - 92
1.30.093.610/0200	2 - 49	1.30.240.011/1007	2 - 92	1.30.240.061/1507	2 - 95	1.30.240.111/0401	2 - 92
1.30.093.611/2000	2 - 49	1.30.240.011/1008	2 - 92	1.30.240.061/1508	2 - 95	1.30.240.111/0407	2 - 92
1.30.093.620/0200	2 - 50	1.30.240.011/1301	2 - 92	1.30.240.061/1601	2 - 95	1.30.240.111/0408	2 - 92
1.30.093.621/2000	2 - 50	1.30.240.011/1307	2 - 92	1.30.240.061/1607	2 - 95	1.30.240.111/0501	2 - 92
1.30.093.650/0200	2 - 48	1.30.240.011/1308	2 - 92	1.30.240.061/1608	2 - 95	1.30.240.111/0507	2 - 92
1.30.093.651/2000	2 - 48	1.30.240.011/1401	2 - 92	1.30.240.071/1000	2 - 95	1.30.240.111/0508	2 - 92
1.30.093.660/0200	2 - 49	1.30.240.011/1407	2 - 92	1.30.240.071/1300	2 - 95	1.30.240.111/0601	2 - 92
1.30.093.661/2000	2 - 49	1.30.240.011/1408	2 - 92	1.30.240.071/1400	2 - 95	1.30.240.111/0607	2 - 92
1.30.093.670/0200	2 - 50	1.30.240.011/1501	2 - 92	1.30.240.071/1500	2 - 95	1.30.240.111/0608	2 - 92
1.30.093.671/2000	2 - 50	1.30.240.011/1507	2 - 92	1.30.240.071/1600	2 - 95	1.30.240.111/0701	2 - 92
1.30.093.700/0200	2 - 49	1.30.240.011/1508	2 - 92	1.30.240.081/1000	2 - 95	1.30.240.111/0707	2 - 92
1.30.093.701/2000	2 - 48	1.30.240.011/1601	2 - 92	1.30.240.081/1300	2 - 95	1.30.240.111/0708	2 - 92
1.30.093.710/0200	2 - 50	1.30.240.011/1607	2 - 92	1.30.240.081/1400	2 - 95	1.30.240.121/0100	2 - 92
1.30.093.711/2000	2 - 49	1.30.240.011/1608	2 - 92	1.30.240.081/1500	2 - 95	1.30.240.121/0200	2 - 92
1.30.093.720/0200	2 - 51	1.30.240.021/1000	2 - 92	1.30.240.081/1600	2 - 95	1.30.240.121/0300	2 - 92
1.30.093.721/2000	2 - 50	1.30.240.021/1300	2 - 92	1.30.240.101/0101	2 - 92	1.30.240.121/0400	2 - 92
1.30.094.001/0300	2 - 57	1.30.240.021/1400	2 - 92	1.30.240.101/0107	2 - 92	1.30.240.121/0500	2 - 92
1.30.094.011/0300	2 - 58	1.30.240.021/1500	2 - 92	1.30.240.101/0108	2 - 92	1.30.240.121/0600	2 - 92
1.30.096.051/0000	2 - 53	1.30.240.021/1600	2 - 92	1.30.240.101/0201	2 - 92	1.30.240.121/0700	2 - 92
1.30.096.061/0000	2 - 54	1.30.240.031/1000	2 - 92	1.30.240.101/0203	2 - 92	1.30.240.131/0100	2 - 92
1.30.096.071/0000	2 - 55	1.30.240.031/1300	2 - 92	1.30.240.101/0204	2 - 92	1.30.240.131/0200	2 - 92
1.30.096.151/0000	2 - 53	1.30.240.031/1400	2 - 92	1.30.240.101/0205	2 - 92	1.30.240.131/0300	2 - 92
1.30.096.161/0000	2 - 54	1.30.240.031/1500	2 - 92	1.30.240.101/0206	2 - 92	1.30.240.131/0400	2 - 92
1.30.096.171/0000	2 - 55	1.30.240.031/1600	2 - 92	1.30.240.101/0207	2 - 92	1.30.240.131/0500	2 - 92
1.30.096.401/0000	2 - 53	1.30.240.051/1001	2 - 95	1.30.240.101/0208	2 - 92	1.30.240.131/0600	2 - 92
1.30.096.411/0000	2 - 54	1.30.240.051/1003	2 - 95	1.30.240.101/0301	2 - 92	1.30.240.131/0700	2 - 92
1.30.096.421/0000	2 - 55	1.30.240.051/1004	2 - 95	1.30.240.101/0307	2 - 92	1.30.240.151/0101	2 - 95
1.30.096.501/0000	2 - 53	1.30.240.051/1005	2 - 95	1.30.240.101/0308	2 - 92	1.30.240.151/0107	2 - 95
1.30.096.511/0000	2 - 54	1.30.240.051/1006	2 - 95	1.30.240.101/0401	2 - 92	1.30.240.151/0108	2 - 95
1.30.096.521/0000	2 - 55	1.30.240.051/1007	2 - 95	1.30.240.101/0407	2 - 92	1.30.240.151/0201	2 - 95
1.30.096.701/0000	2 - 53	1.30.240.051/1008	2 - 95	1.30.240.101/0408	2 - 92	1.30.240.151/0203	2 - 95
1.30.096.711/0000	2 - 54	1.30.240.051/1301	2 - 95	1.30.240.101/0501	2 - 92	1.30.240.151/0204	2 - 95
1.30.096.721/0000	2 - 55	1.30.240.051/1307	2 - 95	1.30.240.101/0507	2 - 92	1.30.240.151/0205	2 - 95
1.30.240.001/1001	2 - 92	1.30.240.051/1308	2 - 95	1.30.240.101/0508	2 - 92	1.30.240.151/0206	2 - 95
1.30.240.001/1003	2 - 92	1.30.240.051/1401	2 - 95	1.30.240.101/0601	2 - 92	1.30.240.151/0207	2 - 95
1.30.240.001/1004	2 - 92	1.30.240.051/1407	2 - 95	1.30.240.101/0607	2 - 92	1.30.240.151/0208	2 - 95
1.30.240.001/1005	2 - 92	1.30.240.051/1408	2 - 95	1.30.240.101/0608	2 - 92	1.30.240.151/0301	2 - 95
1.30.240.001/1006	2 - 92	1.30.240.051/1501	2 - 95	1.30.240.101/0701	2 - 92	1.30.240.151/0307	2 - 95
1.30.240.001/1007	2 - 92	1.30.240.051/1507	2 - 95	1.30.240.101/0707	2 - 92	1.30.240.151/0308	2 - 95
1.30.240.001/1008	2 - 92	1.30.240.051/1508	2 - 95	1.30.240.101/0708	2 - 92	1.30.240.151/0401	2 - 95
1.30.240.001/1301	2 - 92	1.30.240.051/1601	2 - 95	1.30.240.105/0101	2 - 99	1.30.240.151/0407	2 - 95
1.30.240.001/1307	2 - 92	1.30.240.051/1607	2 - 95	1.30.240.105/0108	2 - 99	1.30.240.151/0408	2 - 95
1.30.240.001/1308	2 - 92	1.30.240.051/1608	2 - 95	1.30.240.105/0201	2 - 99	1.30.240.151/0501	2 - 95
1.30.240.001/1401	2 - 92	1.30.240.055/1001	2 - 100	1.30.240.105/0208	2 - 99	1.30.240.151/0507	2 - 95
1.30.240.001/1407	2 - 92	1.30.240.055/1008	2 - 100	1.30.240.105/0301	2 - 99	1.30.240.151/0508	2 - 95
1.30.240.001/1408	2 - 92	1.30.240.055/1301	2 - 100	1.30.240.105/0308	2 - 99	1.30.240.151/0601	2 - 95
1.30.240.001/1501	2 - 92	1.30.240.055/1308	2 - 100	1.30.240.105/0401	2 - 99	1.30.240.151/0607	2 - 95
1.30.240.001/1507	2 - 92	1.30.240.055/1401	2 - 100	1.30.240.105/0408	2 - 99	1.30.240.151/0608	2 - 95
1.30.240.001/1508	2 - 92	1.30.240.055/1408	2 - 100	1.30.240.105/0501	2 - 99	1.30.240.151/0701	2 - 95

APPENDIX

REFERENCE NUMBER GUIDE

Order number	Page	Order number	Page	Order number	Page	Order number	Page
1.30.240.371/0400	2 - 96	1.30.240.501/0607	2 - 94	1.30.242.062/2200	2 - 106	1.30.242.351/2208	2 - 105
1.30.240.371/0500	2 - 96	1.30.240.501/0608	2 - 94	1.30.242.076/2201	2 - 105	1.30.242.352/2200	2 - 105
1.30.240.371/0600	2 - 96	1.30.240.501/0701	2 - 94	1.30.242.076/2207	2 - 105	1.30.242.361/2201	2 - 106
1.30.240.371/0700	2 - 96	1.30.240.501/0707	2 - 94	1.30.242.076/2208	2 - 105	1.30.242.361/2207	2 - 106
1.30.240.381/0100	2 - 96	1.30.240.501/0708	2 - 94	1.30.242.077/2200	2 - 105	1.30.242.361/2208	2 - 106
1.30.240.381/0200	2 - 96	1.30.240.521/0100	2 - 94	1.30.242.086/2201	2 - 106	1.30.242.362/2200	2 - 106
1.30.240.381/0300	2 - 96	1.30.240.521/0200	2 - 94	1.30.242.086/2207	2 - 106	1.30.242.426/2201	2 - 102
1.30.240.381/0400	2 - 96	1.30.240.521/0300	2 - 94	1.30.242.086/2208	2 - 106	1.30.242.426/2207	2 - 102
1.30.240.381/0500	2 - 96	1.30.240.521/0400	2 - 94	1.30.242.087/2200	2 - 106	1.30.242.426/2208	2 - 102
1.30.240.381/0600	2 - 96	1.30.240.521/0500	2 - 94	1.30.242.101/2201	2 - 102	1.30.242.427/2200	2 - 102
1.30.240.381/0700	2 - 96	1.30.240.521/0600	2 - 94	1.30.242.101/2207	2 - 102	1.30.242.436/2201	2 - 104
1.30.240.401/1001	2 - 94	1.30.240.521/0700	2 - 94	1.30.242.101/2208	2 - 102	1.30.242.436/2207	2 - 104
1.30.240.401/1007	2 - 94	1.30.240.551/0101	2 - 97	1.30.242.102/2200	2 - 102	1.30.242.436/2208	2 - 104
1.30.240.401/1008	2 - 94	1.30.240.551/0107	2 - 97	1.30.242.111/2201	2 - 104	1.30.242.437/0200	2 - 104
1.30.240.401/1301	2 - 94	1.30.240.551/0108	2 - 97	1.30.242.111/2207	2 - 104	1.30.242.437/2200	2 - 104
1.30.240.401/1307	2 - 94	1.30.240.551/0201	2 - 97	1.30.242.111/2208	2 - 104	1.30.242.476/2201	2 - 105
1.30.240.401/1308	2 - 94	1.30.240.551/0207	2 - 97	1.30.242.112/2200	2 - 104	1.30.242.476/2207	2 - 105
1.30.240.401/1401	2 - 94	1.30.240.551/0208	2 - 97	1.30.242.126/2201	2 - 102	1.30.242.476/2208	2 - 105
1.30.240.401/1407	2 - 94	1.30.240.551/0301	2 - 97	1.30.242.126/2207	2 - 102	1.30.242.477/0200	2 - 105
1.30.240.401/1408	2 - 94	1.30.240.551/0307	2 - 97	1.30.242.126/2208	2 - 102	1.30.242.477/2200	2 - 105
1.30.240.401/1501	2 - 94	1.30.240.551/0308	2 - 97	1.30.242.127/2200	2 - 102	1.30.242.486/2201	2 - 106
1.30.240.401/1507	2 - 94	1.30.240.551/0401	2 - 97	1.30.242.136/2201	2 - 104	1.30.242.486/2207	2 - 106
1.30.240.401/1508	2 - 94	1.30.240.551/0407	2 - 97	1.30.242.136/2207	2 - 104	1.30.242.486/2208	2 - 106
1.30.240.401/1601	2 - 94	1.30.240.551/0408	2 - 97	1.30.242.136/2208	2 - 104	1.30.242.487/0200	2 - 106
1.30.240.401/1607	2 - 94	1.30.240.551/0501	2 - 97	1.30.242.137/2200	2 - 104	1.30.242.487/2200	2 - 106
1.30.240.401/1608	2 - 94	1.30.240.551/0507	2 - 97	1.30.242.151/2201	2 - 105	1.30.242.501/0201	2 - 102
1.30.240.421/1000	2 - 94	1.30.240.551/0508	2 - 97	1.30.242.151/2207	2 - 105	1.30.242.501/0207	2 - 102
1.30.240.421/1300	2 - 94	1.30.240.551/0601	2 - 97	1.30.242.151/2208	2 - 105	1.30.242.501/0208	2 - 102
1.30.240.421/1400	2 - 94	1.30.240.551/0607	2 - 97	1.30.242.152/2200	2 - 105	1.30.242.502/0200	2 - 102
1.30.240.421/1500	2 - 94	1.30.240.551/0608	2 - 97	1.30.242.161/2201	2 - 106	1.30.242.511/0201	2 - 104
1.30.240.421/1600	2 - 94	1.30.240.551/0701	2 - 97	1.30.242.161/2207	2 - 106	1.30.242.511/0207	2 - 104
1.30.240.451/1001	2 - 97	1.30.240.551/0707	2 - 97	1.30.242.161/2208	2 - 106	1.30.242.511/0208	2 - 104
1.30.240.451/1007	2 - 97	1.30.240.551/0708	2 - 97	1.30.242.162/2200	2 - 106	1.30.242.512/0200	2 - 104
1.30.240.451/1008	2 - 97	1.30.240.571/0100	2 - 97	1.30.242.176/2201	2 - 105	1.30.242.526/0201	2 - 103
1.30.240.451/1301	2 - 97	1.30.240.571/0200	2 - 97	1.30.242.176/2207	2 - 105	1.30.242.526/0207	2 - 103
1.30.240.451/1307	2 - 97	1.30.240.571/0300	2 - 97	1.30.242.176/2208	2 - 105	1.30.242.526/0208	2 - 103
1.30.240.451/1308	2 - 97	1.30.240.571/0400	2 - 97	1.30.242.177/2200	2 - 105	1.30.242.527/0200	2 - 103
1.30.240.451/1401	2 - 97	1.30.240.571/0500	2 - 97	1.30.242.186/2201	2 - 106	1.30.242.536/0201	2 - 104
1.30.240.451/1407	2 - 97	1.30.240.571/0600	2 - 97	1.30.242.186/2207	2 - 106	1.30.242.536/0207	2 - 104
1.30.240.451/1408	2 - 97	1.30.240.571/0700	2 - 97	1.30.242.186/2208	2 - 106	1.30.242.536/0208	2 - 104
1.30.240.451/1501	2 - 97	1.30.241.001/2207	2 - 126	1.30.242.187/2200	2 - 106	1.30.242.537/0200	2 - 104
1.30.240.451/1507	2 - 97	1.30.241.002/2207	2 - 126	1.30.242.201/2201	2 - 102	1.30.242.551/0201	2 - 105
1.30.240.451/1508	2 - 97	1.30.241.051/2207	2 - 126	1.30.242.201/2207	2 - 102	1.30.242.551/0207	2 - 105
1.30.240.451/1601	2 - 97	1.30.241.052/2207	2 - 126	1.30.242.201/2208	2 - 102	1.30.242.551/0208	2 - 105
1.30.240.451/1607	2 - 97	1.30.242.001/2201	2 - 102	1.30.242.202/2200	2 - 102	1.30.242.552/0200	2 - 105
1.30.240.451/1608	2 - 97	1.30.242.001/2207	2 - 102	1.30.242.211/2201	2 - 104	1.30.242.561/0201	2 - 106
1.30.240.471/1000	2 - 97	1.30.242.001/2208	2 - 102	1.30.242.211/2207	2 - 104	1.30.242.561/0207	2 - 106
1.30.240.471/1300	2 - 97	1.30.242.002/2200	2 - 102	1.30.242.211/2208	2 - 104	1.30.242.561/0208	2 - 106
1.30.240.471/1400	2 - 97	1.30.242.011/2201	2 - 103	1.30.242.212/2200	2 - 104	1.30.242.562/0200	2 - 106
1.30.240.471/1500	2 - 97	1.30.242.011/2207	2 - 103	1.30.242.251/2201	2 - 105	1.30.242.576/0201	2 - 105
1.30.240.471/1600	2 - 97	1.30.242.011/2208	2 - 103	1.30.242.251/2207	2 - 105	1.30.242.576/0207	2 - 105
1.30.240.501/0101	2 - 94	1.30.242.012/2200	2 - 103	1.30.242.251/2208	2 - 105	1.30.242.576/0208	2 - 105
1.30.240.501/0107	2 - 94	1.30.242.026/2201	2 - 102	1.30.242.252/2200	2 - 105	1.30.242.577/0200	2 - 105
1.30.240.501/0108	2 - 94	1.30.242.026/2207	2 - 102	1.30.242.261/2201	2 - 106	1.30.242.586/0201	2 - 106
1.30.240.501/0201	2 - 94	1.30.242.026/2208	2 - 102	1.30.242.261/2207	2 - 106	1.30.242.586/0207	2 - 106
1.30.240.501/0207	2 - 94	1.30.242.027/2200	2 - 102	1.30.242.261/2208	2 - 106	1.30.242.586/0208	2 - 106
1.30.240.501/0208	2 - 94	1.30.242.036/2201	2 - 103	1.30.242.262/2200	2 - 106	1.30.242.587/0200	2 - 106
1.30.240.501/0301	2 - 94	1.30.242.036/2207	2 - 103	1.30.242.301/2201	2 - 102	1.30.242.601/0201	2 - 103
1.30.240.501/0307	2 - 94	1.30.242.036/2208	2 - 103	1.30.242.301/2207	2 - 102	1.30.242.601/0207	2 - 103
1.30.240.501/0308	2 - 94	1.30.242.037/2200	2 - 103	1.30.242.301/2208	2 - 102	1.30.242.601/0208	2 - 103
1.30.240.501/0401	2 - 94	1.30.242.051/2201	2 - 105	1.30.242.302/2200	2 - 102	1.30.242.602/0200	2 - 103
1.30.240.501/0407	2 - 94	1.30.242.051/2207	2 - 105	1.30.242.311/2201	2 - 104	1.30.242.611/0201	2 - 104
1.30.240.501/0408	2 - 94	1.30.242.051/2208	2 - 105	1.30.242.311/2207	2 - 104	1.30.242.611/0207	2 - 104
1.30.240.501/0501	2 - 94	1.30.242.052/2200	2 - 105	1.30.242.311/2208	2 - 104	1.30.242.611/0208	2 - 104
1.30.240.501/0507	2 - 94	1.30.242.061/2201	2 - 106	1.30.242.312/2200	2 - 104	1.30.242.612/0200	2 - 104
1.30.240.501/0508	2 - 94	1.30.242.061/2207	2 - 106	1.30.242.351/2201	2 - 105	1.30.242.626/0201	2 - 103
1.30.240.501/0601	2 - 94	1.30.242.061/2208	2 - 106	1.30.242.351/2207	2 - 105	1.30.242.626/0207	2 - 103

Order number	Page	Order number	Page	Order number	Page	Order number	Page
1.30.272.201/2203	2 - 174	1.30.275.102/0000	2 - 180	1.30.290.031/2400	2 - 222	1.63.521.006/1300	3 - 29
1.30.272.201/2204	2 - 174	1.30.275.151/0100	2 - 181	1.30.290.031/2500	2 - 222	1.63.521.006/1400	3 - 29
1.30.272.201/2205	2 - 174	1.30.275.151/0700	2 - 181	1.30.290.031/2600	2 - 222	1.63.521.006/1500	3 - 29
1.30.272.201/2206	2 - 174	1.30.275.151/0800	2 - 181	1.30.290.921/0000	2 - 225	1.63.521.007/1000	3 - 29
1.30.272.201/2207	2 - 174	1.30.275.152/0000	2 - 181	1.30.290.931/0000	2 - 225	1.63.521.007/1300	3 - 29
1.30.272.201/2208	2 - 174	1.30.275.221/0100	2 - 180	1.30.292.002/2200	2 - 227	1.63.521.007/1400	3 - 29
1.30.272.202/2200	2 - 174	1.30.275.221/0700	2 - 180	1.30.292.027/2200	2 - 227	1.63.521.007/1500	3 - 29
1.30.272.251/2201	2 - 175	1.30.275.221/0800	2 - 180	1.30.292.102/2200	2 - 227	1.63.521.012/1000	3 - 30
1.30.272.251/2203	2 - 175	1.30.275.222/0000	2 - 180	1.30.292.202/2200	2 - 227	1.63.521.012/1300	3 - 30
1.30.272.251/2204	2 - 175	1.30.275.271/0100	2 - 181	1.30.292.302/2200	2 - 227	1.63.521.012/1400	3 - 30
1.30.272.251/2205	2 - 175	1.30.275.271/0700	2 - 181	1.30.292.427/2200	2 - 227	1.63.521.012/1500	3 - 30
1.30.272.251/2206	2 - 175	1.30.275.271/0800	2 - 181	1.30.295.002/0000	2 - 229	1.63.521.013/1000	3 - 30
1.30.272.251/2207	2 - 175	1.30.275.272/0000	2 - 181	1.30.295.102/0000	2 - 229	1.63.521.013/1300	3 - 30
1.30.272.251/2208	2 - 175	1.30.275.321/0100	2 - 180	1.30.295.222/0000	2 - 229	1.63.521.013/1400	3 - 30
1.30.272.252/2200	2 - 175	1.30.275.321/0700	2 - 180	1.30.295.322/0000	2 - 229	1.63.521.013/1500	3 - 30
1.30.272.301/2201	2 - 174	1.30.275.321/0800	2 - 180	1.30.299.021/0700	2 - 233	1.63.521.014/1000	3 - 30
1.30.272.301/2203	2 - 174	1.30.275.322/0000	2 - 180	1.60.502.151/1000	3 - 22	1.63.521.014/1300	3 - 30
1.30.272.301/2204	2 - 174	1.30.275.371/0100	2 - 181	1.60.502.151/1300	3 - 22	1.63.521.014/1400	3 - 30
1.30.272.301/2205	2 - 174	1.30.275.371/0700	2 - 181	1.60.502.151/1400	3 - 22	1.63.521.014/1500	3 - 30
1.30.272.301/2206	2 - 174	1.30.275.371/0800	2 - 181	1.60.502.151/1500	3 - 22	1.63.521.024/1000	3 - 28
1.30.272.301/2207	2 - 174	1.30.275.372/0000	2 - 181	1.60.502.151/1600	3 - 22	1.63.521.024/1300	3 - 28
1.30.272.301/2208	2 - 174	1.30.275.501/0100	2 - 180	1.60.502.152/1000	3 - 21	1.63.521.024/1400	3 - 28
1.30.272.302/2200	2 - 174	1.30.275.501/0700	2 - 180	1.60.502.152/1300	3 - 21	1.63.521.024/1500	3 - 28
1.30.272.351/2201	2 - 175	1.30.275.501/0800	2 - 180	1.60.502.152/1400	3 - 21	1.65.111.051/0000	1 - 48
1.30.272.351/2203	2 - 175	1.30.275.502/0000	2 - 180	1.60.502.152/1500	3 - 21	1.65.111.056/0000	1 - 59
1.30.272.351/2204	2 - 175	1.30.275.551/0100	2 - 181	1.60.502.152/1600	3 - 21	1.65.111.061/0000	1 - 47
1.30.272.351/2205	2 - 175	1.30.275.551/0700	2 - 181	1.60.502.162/1000	3 - 21	1.65.111.066/0000	1 - 61
1.30.272.351/2206	2 - 175	1.30.275.551/0800	2 - 181	1.60.502.162/1300	3 - 21	1.65.111.071/0000	1 - 46
1.30.272.351/2207	2 - 175	1.30.275.552/0000	2 - 181	1.60.502.162/1400	3 - 21	1.65.111.076/0000	1 - 59
1.30.272.351/2208	2 - 175	1.30.276.001/2200	2 - 183	1.60.502.162/1500	3 - 21	1.65.111.081/0000	1 - 47
1.30.272.352/2200	2 - 175	1.30.276.101/2200	2 - 183	1.60.502.162/1600	3 - 21	1.65.111.086/0000	1 - 60
1.30.272.426/2201	2 - 174	1.30.276.201/2200	2 - 183	1.61.012.015/1000	3 - 26	1.65.111.096/0000	1 - 58
1.30.272.426/2203	2 - 174	1.30.276.501/0000	2 - 183	1.61.012.015/1300	3 - 26	1.65.121.906/0000	1 - 13
1.30.272.426/2204	2 - 174	1.30.276.601/0000	2 - 183	1.61.012.015/1400	3 - 26	1.65.121.936/0000	1 - 12
1.30.272.426/2205	2 - 174	1.30.276.701/0000	2 - 183	1.61.012.015/1500	3 - 26	1.65.121.966/0000	1 - 13
1.30.272.426/2206	2 - 174	1.30.279.001/0707	2 - 199	1.61.012.062/1000	3 - 26	1.65.122.906/0000	1 - 33
1.30.272.426/2207	2 - 174	1.30.279.021/0700	2 - 199	1.61.012.062/1300	3 - 26	1.65.122.956/0000	1 - 34
1.30.272.426/2208	2 - 174	1.30.279.051/0707	2 - 199	1.61.012.062/1400	3 - 26	1.65.124.001/1002	2 - 40
1.30.272.427/2200	2 - 174	1.30.279.071/0700	2 - 199	1.61.012.062/1500	3 - 26	1.65.124.001/1306	2 - 40
1.30.272.476/2201	2 - 175	1.30.280.001/0101	2 - 207	1.63.004.011/1000	3 - 19	1.65.124.001/1403	2 - 40
1.30.272.476/2203	2 - 175	1.30.280.001/2201	2 - 207	1.63.004.011/1300	3 - 19	1.65.124.001/1505	2 - 40
1.30.272.476/2204	2 - 175	1.30.280.001/2301	2 - 207	1.63.004.011/1400	3 - 19	1.65.124.001/1607	2 - 40
1.30.272.476/2205	2 - 175	1.30.280.001/2401	2 - 207	1.63.004.011/1500	3 - 19	1.65.124.021/1002	2 - 41
1.30.272.476/2206	2 - 175	1.30.280.001/2501	2 - 207	1.63.004.011/1600	3 - 19	1.65.124.021/1306	2 - 41
1.30.272.476/2207	2 - 175	1.30.280.001/2601	2 - 207	1.63.004.020/1000	3 - 19	1.65.124.021/1403	2 - 41
1.30.272.476/2208	2 - 175	1.30.282.001/2201	2 - 209	1.63.004.020/1300	3 - 19	1.65.124.021/1505	2 - 41
1.30.272.477/2200	2 - 175	1.30.282.026/2201	2 - 209	1.63.004.020/1400	3 - 19	1.65.124.101/0000	2 - 40
1.30.273.001/2200	2 - 185	1.30.282.101/2201	2 - 209	1.63.004.020/1500	3 - 19	1.65.124.101/0000	2 - 41
1.30.273.001/2300	2 - 185	1.30.282.201/2201	2 - 209	1.63.004.020/1600	3 - 19	1.65.124.301/1002	2 - 40
1.30.273.101/2200	2 - 186	1.30.282.301/2201	2 - 209	1.63.018.011/1000	3 - 24	1.65.124.301/1306	2 - 40
1.30.273.101/2300	2 - 186	1.30.283.101/2200	2 - 214	1.63.018.011/1300	3 - 24	1.65.124.301/1403	2 - 40
1.30.273.301/2200	2 - 188	1.30.283.111/2300	2 - 213	1.63.018.011/1400	3 - 24	1.65.124.301/1505	2 - 40
1.30.273.501/0300	2 - 185	1.30.283.601/0300	2 - 214	1.63.018.011/1500	3 - 24	1.65.124.301/1607	2 - 40
1.30.273.502/0300	2 - 190	1.30.283.611/0300	2 - 213	1.63.018.011/1600	3 - 24	1.65.124.401/0000	2 - 40
1.30.273.601/0300	2 - 186	1.30.285.001/0100	2 - 211	1.63.521.002/1000	3 - 28	1.65.126.001/1000	2 - 61
1.30.273.602/0300	2 - 191	1.30.285.101/0100	2 - 211	1.63.521.002/1300	3 - 28	1.65.126.001/1300	2 - 60
1.30.275.001/0100	2 - 180	1.30.285.221/0100	2 - 211	1.63.521.002/1400	3 - 28	1.65.126.001/1400	2 - 60
1.30.275.001/0700	2 - 180	1.30.285.321/0100	2 - 211	1.63.521.002/1500	3 - 28	1.65.126.001/1500	2 - 60
1.30.275.001/0800	2 - 180	1.30.290.021/0100	2 - 222	1.63.521.003/1000	3 - 28	1.65.126.001/1600	2 - 61
1.30.275.002/0000	2 - 180	1.30.290.021/2200	2 - 222	1.63.521.003/1300	3 - 28	1.65.126.011/1000	2 - 61
1.30.275.051/0100	2 - 181	1.30.290.021/2300	2 - 222	1.63.521.003/1400	3 - 28	1.65.126.011/1300	2 - 61
1.30.275.051/0700	2 - 181	1.30.290.021/2400	2 - 222	1.63.521.003/1500	3 - 28	1.65.126.011/1400	2 - 61
1.30.275.051/0800	2 - 181	1.30.290.021/2500	2 - 222	1.63.521.005/1000	3 - 29	1.65.126.011/1500	2 - 61
1.30.275.052/0000	2 - 181	1.30.290.021/2600	2 - 222	1.63.521.005/1300	3 - 29	1.65.126.011/1600	2 - 61
1.30.275.101/0100	2 - 180	1.30.290.031/0100	2 - 222	1.63.521.005/1400	3 - 29	1.65.126.101/0000	2 - 60
1.30.275.101/0700	2 - 180	1.30.290.031/2200	2 - 222	1.63.521.005/1500	3 - 29	1.65.126.101/0000	2 - 61
1.30.275.101/0800	2 - 180	1.30.290.031/2300	2 - 222	1.63.521.006/1000	3 - 29	1.65.126.301/1000	2 - 60

APPENDIX

REFERENCE NUMBER GUIDE

Order number	Page	Order number	Page	Order number	Page	Order number	Page
1.65.126.301/1300	2 - 60	1.69.525.265/1400	3 - 15	1.90.060.003/0000	5 - 11	1.90.692.001/0000	5 - 7
1.65.126.301/1400	2 - 60	1.69.525.266/1600	3 - 15	1.90.060.014/0000	5 - 11	1.90.692.002/0000	5 - 7
1.65.126.301/1500	2 - 60	1.69.525.271/1000	3 - 15	1.90.060.132/0000	5 - 11	1.90.692.003/0000	5 - 7
1.65.126.301/1600	2 - 60	1.69.527.104/1002	3 - 36	1.90.060.133/0000	5 - 11	1.90.900.001/0000	5 - 6
1.65.126.401/0000	2 - 60	1.69.527.104/1301	3 - 36	1.90.060.137/0000	5 - 11	1.90.900.001/0000	5 - 10
1.66.003.081/1000	3 - 17	1.69.527.104/1402	3 - 36	1.90.070.003/0000	5 - 12	1.90.900.001/0000	5 - 26
1.66.003.081/1300	3 - 17	1.71.212.001/0000	2 - 74	1.90.070.004/0000	5 - 12	1.90.900.002/0000	1 - 38
1.66.003.081/1400	3 - 17	1.71.212.011/0000	2 - 74	1.90.070.053/0000	5 - 13	1.90.900.002/0000	1 - 52
1.66.003.081/1500	3 - 17	1.71.213.001/0000	2 - 142	1.90.070.061/0000	5 - 13	1.90.900.002/0000	1 - 57
1.66.003.081/1600	3 - 17	1.71.213.004/0000	2 - 142	1.90.070.105/0000	5 - 13	1.90.900.002/0000	5 - 10
1.69.507.117/1002	3 - 38	1.71.214.001/0000	2 - 142	1.90.100.012/0000	5 - 11	1.90.900.002/0000	5 - 11
1.69.507.117/1301	3 - 38	1.74.505.501/1000	2 - 132	1.90.100.013/0000	5 - 11	1.90.900.002/0000	5 - 26
1.69.507.117/1402	3 - 38	1.74.505.501/1300	2 - 132	1.90.100.022/0000	5 - 10	1.90.900.003/0000	5 - 5
1.69.507.118/1502	3 - 38	1.74.505.501/1400	2 - 132	1.90.111.003/0000	5 - 15	1.90.900.003/0000	5 - 9
1.69.507.137/1002	3 - 38	1.74.505.501/1500	2 - 132	1.90.111.103/0000	5 - 16	1.90.900.003/0000	5 - 26
1.69.507.137/1301	3 - 38	1.74.505.501/1600	2 - 132	1.90.120.005/0000	5 - 9	1.90.900.004/0000	1 - 38
1.69.507.137/1402	3 - 38	1.74.505.511/1000	2 - 133	1.90.120.009/0000	5 - 9	1.90.900.004/0000	1 - 52
1.69.507.138/1502	3 - 38	1.74.505.511/1300	2 - 133	1.90.120.010/0000	5 - 9	1.90.900.004/0000	1 - 58
1.69.507.157/1002	3 - 39	1.74.505.511/1400	2 - 133	1.90.120.011/0000	5 - 9	1.90.900.004/0000	5 - 7
1.69.507.157/1301	3 - 39	1.74.505.511/1500	2 - 133	1.90.120.012/0000	5 - 9	1.90.900.004/0000	5 - 26
1.69.507.157/1402	3 - 39	1.74.505.511/1600	2 - 133	1.90.180.473/0000	5 - 10	1.90.900.005/0000	5 - 26
1.69.507.158/1502	3 - 39	1.74.505.551/1000	2 - 133	1.90.180.474/0000	5 - 10	1.90.900.006/0000	5 - 11
1.69.508.804/0000	3 - 6	1.74.505.551/1300	2 - 133	1.90.180.475/0000	5 - 10	1.90.900.006/0000	5 - 14
1.69.508.810/0000	3 - 6	1.74.505.551/1400	2 - 133	1.90.510.012/0000	5 - 14	1.90.900.006/0000	5 - 26
1.69.508.816/0000	3 - 6	1.74.505.551/1500	2 - 133	1.90.520.002/0000	5 - 15	1.90.900.007/0000	5 - 8
1.69.508.834/1301	3 - 6	1.74.505.551/1600	2 - 133	1.90.560.002/0000	5 - 12	1.90.900.007/0000	5 - 11
1.69.508.835/1300	3 - 6	1.74.505.561/1000	2 - 134	1.90.560.102/0000	5 - 12	1.90.900.007/0000	5 - 12
1.69.508.840/1503	3 - 6	1.74.505.561/1300	2 - 134	1.90.690.228/0000	2 - 263	1.90.900.007/0000	5 - 13
1.69.508.846/1402	3 - 6	1.74.505.561/1400	2 - 134	1.90.690.228/0000	5 - 8	1.90.900.007/0000	5 - 26
1.69.508.847/1400	3 - 6	1.74.505.561/1500	2 - 134	1.90.690.267/0000	2 - 263	1.90.900.008/0000	5 - 12
1.69.508.864/1301	3 - 7	1.74.505.561/1600	2 - 134	1.90.690.267/0000	5 - 8	1.90.900.008/0000	5 - 14
1.69.508.865/1300	3 - 7	1.74.508.001/2200	2 - 195	1.90.690.269/0000	2 - 263	1.90.900.008/0000	5 - 15
1.69.508.870/1503	3 - 7	1.74.508.001/2300	2 - 195	1.90.690.269/0000	5 - 8	1.90.900.008/0000	5 - 26
1.69.508.876/1402	3 - 7	1.74.508.001/2400	2 - 195	1.90.690.282/0000	2 - 263	1.90.900.009/0000	5 - 13
1.69.508.877/1400	3 - 7	1.74.508.001/2500	2 - 195	1.90.690.282/0000	5 - 8	1.90.900.009/0000	5 - 14
1.69.508.934/1301	3 - 7	1.74.508.001/2600	2 - 195	1.90.690.295/0000	2 - 263	1.90.900.009/0000	5 - 15
1.69.508.935/1300	3 - 7	1.74.508.011/2200	2 - 195	1.90.690.295/0000	5 - 8	1.90.900.009/0000	5 - 26
1.69.508.940/1503	3 - 7	1.74.508.011/2300	2 - 195	1.90.690.331/0000	5 - 7	3.13.001.010/0000	4 - 157
1.69.508.946/1402	3 - 7	1.74.508.011/2400	2 - 195	1.90.690.332/0000	5 - 7	3.13.001.110/0000	4 - 159
1.69.508.947/1400	3 - 7	1.74.508.011/2500	2 - 195	1.90.690.333/0000	5 - 7	3.13.001.130/0000	4 - 160
1.69.511.059/1002	3 - 34	1.74.508.011/2600	2 - 195	1.90.690.334/0000	5 - 7	3.13.001.210/0000	4 - 157
1.69.511.059/1301	3 - 34	1.74.508.051/2200	2 - 196	1.90.690.335/0000	5 - 7	3.13.002.022/0000	4 - 155
1.69.511.059/1402	3 - 34	1.74.508.051/2300	2 - 196	1.90.690.341/0000	1 - 86	3.13.002.102/0000	4 - 154
1.69.511.101/1000	3 - 10	1.74.508.051/2400	2 - 196	1.90.690.341/0000	5 - 8	3.13.002.502/0000	4 - 151
1.69.511.102/1300	3 - 10	1.74.508.051/2500	2 - 196	1.90.690.342/0000	1 - 86	3.13.002.512/0000	4 - 151
1.69.511.103/1400	3 - 10	1.74.508.051/2600	2 - 196	1.90.690.342/0000	5 - 8	3.13.002.922/0000	4 - 155
1.69.511.104/1500	3 - 10	1.74.508.061/2200	2 - 196	1.90.690.343/0000	1 - 86	3.13.005.001/0000	4 - 152
1.69.511.105/1600	3 - 10	1.74.508.061/2300	2 - 196	1.90.690.343/0000	5 - 8	3.13.005.011/0000	4 - 152
1.69.525.001/0000	3 - 14	1.74.508.061/2400	2 - 196	1.90.690.344/0000	1 - 86	3.13.007.001/0152	4 - 182
1.69.525.004/0000	3 - 14	1.74.508.061/2500	2 - 196	1.90.690.344/0000	5 - 8	3.13.007.011/0152	4 - 182
1.69.525.006/0000	3 - 14	1.74.508.061/2600	2 - 196	1.90.690.345/0000	1 - 86	3.13.007.021/0152	4 - 182
1.69.525.009/0000	3 - 14	1.74.509.011/2200	2 - 216	1.90.690.345/0000	5 - 8	3.13.007.031/0152	4 - 182
1.69.525.011/0000	3 - 14	1.74.509.011/2300	2 - 216	1.90.690.351/0000	5 - 6	3.13.009.001/0000	4 - 178
1.69.525.014/0000	3 - 14	1.74.509.011/2400	2 - 216	1.90.690.352/0000	5 - 6	3.13.009.006/0000	4 - 178
1.69.525.051/0000	3 - 14	1.74.509.011/2500	2 - 216	1.90.690.353/0000	5 - 6	3.13.009.031/0000	4 - 178
1.69.525.054/0000	3 - 14	1.74.509.011/2600	2 - 216	1.90.690.354/0000	5 - 6	3.13.009.036/0000	4 - 178
1.69.525.056/0000	3 - 14	1.74.510.011/2200	2 - 231	1.90.690.355/0000	5 - 6	3.13.026.001/0000	4 - 176
1.69.525.059/0000	3 - 14	1.74.510.011/2300	2 - 231	1.90.690.361/0000	5 - 5	3.13.026.006/0000	4 - 176
1.69.525.061/0000	3 - 14	1.74.510.011/2400	2 - 231	1.90.690.362/0000	5 - 5	3.13.026.011/0000	4 - 176
1.69.525.064/0000	3 - 14	1.74.510.011/2500	2 - 231	1.90.690.363/0000	5 - 5	3.13.026.016/0000	4 - 176
1.69.525.205/1300	3 - 15	1.74.510.011/2600	2 - 231	1.90.690.364/0000	5 - 5	3.13.026.021/0000	4 - 176
1.69.525.210/1500	3 - 15	1.90.010.033/0000	5 - 13	1.90.690.365/0000	5 - 5	3.13.026.026/0000	4 - 176
1.69.525.215/1400	3 - 15	1.90.010.037/0000	5 - 13	1.90.690.684/0000	2 - 263	3.13.026.031/0000	4 - 176
1.69.525.216/1600	3 - 15	1.90.020.033/0000	5 - 14	1.90.690.684/0000	5 - 8	3.13.026.036/0000	4 - 176
1.69.525.221/1000	3 - 15	1.90.020.061/0000	5 - 15	1.90.691.026/0000	5 - 6	3.13.026.041/0000	4 - 176
1.69.525.255/1300	3 - 15	1.90.020.105/0000	5 - 14	1.90.691.027/0000	5 - 6	3.13.026.501/0000	4 - 176
1.69.525.260/1500	3 - 15	1.90.020.115/0000	5 - 14	1.90.691.028/0000	5 - 6	3.13.026.506/0000	4 - 176

Order number	Page	Order number	Page	Order number	Page	Order number	Page
3.13.026.511/0000	4 - 176	3.14.002.684/0000	4 - 89	3.99.400.100/3000	4 - 132	5.00.645.036/0000	1 - 11
3.13.026.516/0000	4 - 176	3.14.002.688/0000	4 - 90	3.99.400.100/5000	4 - 132	5.00.645.036/0000	1 - 20
3.13.026.521/0000	4 - 176	3.14.002.689/0000	4 - 90	3.99.400.100/8000	4 - 132	5.00.645.036/0000	1 - 25
3.13.026.526/0000	4 - 176	3.14.002.901/0000	4 - 84	3.99.400.111/2400	4 - 126	5.00.645.036/0000	1 - 27
3.13.026.531/0000	4 - 176	3.14.002.908/0000	4 - 93	3.99.400.111/3300	4 - 126	5.00.645.036/0000	1 - 30
3.13.026.536/0000	4 - 176	3.14.002.909/0000	4 - 93	3.99.400.111/4500	4 - 126	5.00.645.036/0000	1 - 32
3.13.026.541/0000	4 - 176	3.14.002.910/0000	4 - 93	3.99.400.111/5500	4 - 126	5.00.645.036/0000	5 - 28
3.13.026.601/0000	4 - 176	3.14.002.911/0000	4 - 93	3.99.400.111/6600	4 - 126	5.00.999.500/0000	4 - 166
3.13.026.606/0000	4 - 176	3.14.002.944/0000	4 - 85	3.99.400.111/7600	4 - 126	5.00.999.504/0000	4 - 167
3.13.026.851/0000	4 - 176	3.14.100.001/0000	4 - 60	3.99.400.111/8300	4 - 126	5.00.999.525/0000	4 - 166
3.13.026.856/0000	4 - 176	3.14.100.006/0000	4 - 60	3.99.400.112/2400	4 - 126	5.00.999.529/0000	4 - 167
3.13.027.001/0000	4 - 180	3.14.100.030/0000	4 - 61	3.99.400.112/3300	4 - 126	5.00.999.824/0000	4 - 166
3.13.027.006/0000	4 - 180	3.14.100.031/0000	4 - 61	3.99.400.112/4500	4 - 126	5.00.999.825/0000	4 - 166
3.13.027.011/0000	4 - 180	3.14.100.032/0000	4 - 61	3.99.400.112/5500	4 - 127	5.00.999.826/0000	4 - 167
3.13.027.016/0000	4 - 180	3.14.100.033/0000	4 - 61	3.99.400.112/6600	4 - 127	5.00.999.827/0000	4 - 167
3.13.027.501/0000	4 - 180	3.14.100.040/0000	4 - 61	3.99.400.112/7600	4 - 127	5.03.771.306/0000	1 - 8
3.13.027.506/0000	4 - 180	3.14.100.041/0000	4 - 61	3.99.400.112/8300	4 - 127	5.03.771.306/0000	1 - 12
3.13.027.511/0000	4 - 180	3.14.100.042/0000	4 - 61	3.99.400.141/2000	4 - 129	5.03.771.306/0000	1 - 20
3.13.027.516/0000	4 - 180	3.14.100.043/0000	4 - 61	3.99.400.141/3000	4 - 129	5.03.771.306/0000	1 - 25
3.14.001.001/0000	4 - 84	3.14.100.501/0000	4 - 70	3.99.400.141/5000	4 - 129	5.03.771.306/0000	1 - 27
3.14.001.006/0000	4 - 84	3.14.100.506/0000	4 - 70	3.99.400.141/6000	4 - 129	5.03.771.306/0000	1 - 30
3.14.001.030/0000	4 - 85	3.14.100.531/0000	4 - 71	3.99.400.142/2000	4 - 129	5.03.771.306/0000	1 - 33
3.14.001.031/0000	4 - 85	3.14.100.532/0000	4 - 71	3.99.400.142/3000	4 - 129	5.03.771.306/0000	5 - 29
3.14.001.032/0000	4 - 85	3.14.100.533/0000	4 - 71	3.99.400.142/5000	4 - 129	5.03.772.261/0000	4 - 125
3.14.001.033/0000	4 - 85	3.14.100.541/0000	4 - 71	3.99.400.142/6000	4 - 129	5.03.772.261/0000	4 - 141
3.14.001.040/0000	4 - 85	3.14.100.542/0000	4 - 71	5.00.070.078/0000	2 - 142	5.03.772.262/0000	4 - 131
3.14.001.041/0000	4 - 85	3.14.100.543/0000	4 - 71	5.00.070.080/0000	2 - 142	5.03.772.262/0000	4 - 141
3.14.001.042/0000	4 - 85	3.14.100.601/0000	4 - 66	5.00.070.083/0200	2 - 144	5.04.520.171/0152	4 - 168
3.14.001.043/0000	4 - 85	3.14.100.606/0000	4 - 66	5.00.070.083/0300	2 - 144	5.04.520.171/0242	4 - 168
3.14.001.501/0000	4 - 89	3.14.100.702/0000	4 - 76	5.00.070.083/0400	2 - 144	5.04.520.171/0710	4 - 168
3.14.001.506/0000	4 - 89	3.14.100.707/0000	4 - 76	5.00.070.083/0500	2 - 144	5.04.520.171/0801	4 - 168
3.14.001.659/0000	4 - 94	3.14.100.801/0000	4 - 70	5.00.070.083/0600	2 - 144	5.04.520.172/0152	4 - 168
3.14.002.011/0000	4 - 84	3.14.100.806/0000	4 - 70	5.00.070.085/0200	2 - 144	5.04.520.172/0242	4 - 168
3.14.002.012/0000	4 - 84	3.14.100.830/0000	4 - 72	5.00.070.085/0300	2 - 144	5.04.520.172/0710	4 - 168
3.14.002.013/0000	4 - 84	3.14.100.831/0000	4 - 71	5.00.070.085/0400	2 - 144	5.04.520.172/0801	4 - 168
3.14.002.014/0000	4 - 84	3.14.100.832/0000	4 - 71	5.00.070.085/0500	2 - 144	5.04.520.173/0152	4 - 168
3.14.002.015/0000	4 - 84	3.14.100.833/0000	4 - 71	5.00.070.085/0600	2 - 144	5.04.520.173/0242	4 - 168
3.14.002.021/0000	4 - 84	3.14.200.011/0000	4 - 60	5.00.070.086/0200	2 - 144	5.04.520.173/0710	4 - 168
3.14.002.022/0000	4 - 84	3.14.200.012/0000	4 - 60	5.00.070.086/0300	2 - 144	5.04.520.173/0801	4 - 168
3.14.002.023/0000	4 - 84	3.14.200.013/0000	4 - 60	5.00.070.086/0400	2 - 144	5.04.520.174/0152	4 - 168
3.14.002.024/0000	4 - 84	3.14.200.014/0000	4 - 60	5.00.070.086/0500	2 - 144	5.04.520.174/0242	4 - 169
3.14.002.025/0000	4 - 85	3.14.200.015/0000	4 - 60	5.00.070.086/0600	2 - 144	5.04.520.174/0710	4 - 169
3.14.002.026/0000	4 - 85	3.14.200.021/0000	4 - 60	5.00.070.087/0000	2 - 142	5.04.520.174/0801	4 - 169
3.14.002.027/0000	4 - 85	3.14.200.022/0000	4 - 61	5.00.100.139/0000	2 - 136	5.04.665.161/5520	4 - 165
3.14.002.051/0000	4 - 94	3.14.200.023/0000	4 - 60	5.00.100.140/0000	2 - 136	5.04.665.170/5520	4 - 165
3.14.002.052/0000	4 - 94	3.14.200.024/0000	4 - 60	5.00.100.141/0000	2 - 136	5.04.665.221/5520	4 - 162
3.14.002.053/0000	4 - 94	3.14.200.025/0000	4 - 61	5.00.100.142/0000	2 - 136	5.04.665.230/5520	4 - 162
3.14.002.054/0000	4 - 94	3.14.200.051/0000	4 - 80	5.00.100.143/0000	2 - 136	5.04.665.521/5520	4 - 164
3.14.002.061/0000	4 - 93	3.14.200.052/0000	4 - 80	5.00.100.144/0000	2 - 136	5.04.665.530/5520	4 - 164
3.14.002.062/0000	4 - 93	3.14.200.053/0000	4 - 80	5.00.100.145/0000	2 - 136	5.04.665.911/5520	4 - 164
3.14.002.063/0000	4 - 93	3.14.200.054/0000	4 - 80	5.00.100.159/0000	2 - 139	5.04.665.920/5520	4 - 164
3.14.002.064/0000	4 - 93	3.14.200.055/0000	4 - 80	5.00.100.160/0000	2 - 139	5.04.903.009/0000	4 - 131
3.14.002.071/0000	4 - 94	3.14.200.731/0000	4 - 76	5.00.100.161/0000	2 - 139	5.04.903.009/0000	4 - 140
3.14.002.072/0000	4 - 94	3.14.200.732/0000	4 - 76	5.00.100.162/0000	2 - 139	5.04.903.010/0000	4 - 131
3.14.002.073/0000	4 - 94	3.14.200.733/0000	4 - 76	5.00.100.163/0000	2 - 139	5.04.903.010/0000	4 - 140
3.14.002.074/0000	4 - 94	3.14.200.735/0000	4 - 76	5.00.100.164/0000	2 - 139	5.04.903.011/0000	4 - 131
3.14.002.613/0000	4 - 89	3.14.200.736/0000	4 - 76	5.00.100.165/0000	2 - 139	5.04.903.011/0000	4 - 141
3.14.002.623/0000	4 - 89	3.14.200.738/0000	4 - 76	5.00.100.193/0000	2 - 139	5.04.914.000/2000	4 - 125
3.14.002.632/0000	4 - 89	3.14.200.739/0000	4 - 76	5.00.100.194/0000	2 - 136	5.04.914.000/2000	4 - 133
3.14.002.633/0000	4 - 89	3.14.200.741/0000	4 - 76	5.00.100.195/0000	2 - 139	5.04.914.100/2000	4 - 134
3.14.002.642/0000	4 - 90	3.14.200.742/0000	4 - 77	5.00.100.196/0000	2 - 136	5.04.914.101/0100	4 - 134
3.14.002.643/0000	4 - 89	3.14.200.743/0000	4 - 76	5.00.456.001/0000	2 - 185	5.04.914.101/2000	4 - 134
3.14.002.653/0000	4 - 89	3.14.200.745/0000	4 - 77	5.00.456.001/0000	2 - 265	5.04.914.102/0100	4 - 134
3.14.002.663/0000	4 - 89	3.14.200.746/0000	4 - 76	5.00.456.002/0000	2 - 150	5.04.914.102/2000	4 - 134
3.14.002.673/0000	4 - 89	3.14.200.748/0000	4 - 76	5.00.456.002/0000	2 - 213	5.04.914.103/0100	4 - 134
3.14.002.678/0000	4 - 89	3.14.200.749/0000	4 - 77	5.00.456.002/0000	2 - 266	5.04.914.103/2000	4 - 134
3.14.002.683/0000	4 - 89	3.99.400.100/2000	4 - 132	5.00.645.036/0000	1 - 8	5.04.914.104/0100	4 - 134

APPENDIX

REFERENCE NUMBER GUIDE

Order number	Page	Order number	Page	Order number	Page	Order number	Page
5.04.914.104/2000	4 - 134	5.04.916.100/2000	4 - 137	5.05.200.025/0000	5 - 24	5.05.511.747/0500	2 - 262
5.04.914.105/0100	4 - 134	5.04.916.101/2000	4 - 137	5.05.200.026/0000	2 - 267	5.05.511.747/0600	2 - 262
5.04.914.105/2000	4 - 134	5.04.916.102/2000	4 - 137	5.05.200.026/0000	5 - 24	5.05.511.747/1200	2 - 262
5.04.914.106/0100	4 - 134	5.04.916.103/2000	4 - 137	5.05.510.298/0000	1 - 66	5.05.511.747/1300	2 - 262
5.04.914.106/2000	4 - 134	5.04.916.104/2000	4 - 137	5.05.510.298/0000	1 - 69	5.05.511.747/1400	2 - 262
5.04.914.121/0100	4 - 134	5.04.916.105/2000	4 - 137	5.05.510.298/0000	1 - 71	5.05.511.747/1500	2 - 262
5.04.914.121/2000	4 - 134	5.04.916.106/2000	4 - 137	5.05.510.421/0000	2 - 76	5.05.511.747/1600	2 - 262
5.04.914.122/0100	4 - 134	5.04.916.107/2000	4 - 137	5.05.510.644/0000	2 - 75	5.05.511.855/9000	2 - 261
5.04.914.122/2000	4 - 134	5.04.916.108/2000	4 - 137	5.05.510.645/0000	2 - 75	5.05.511.917/0000	2 - 258
5.04.914.123/0100	4 - 134	5.04.916.109/2000	4 - 137	5.05.510.646/0000	2 - 75	5.05.800.027/0000	1 - 41
5.04.914.123/2000	4 - 134	5.04.916.110/2000	4 - 137	5.05.510.647/0000	2 - 75	5.05.800.027/0000	5 - 29
5.04.914.124/0400	4 - 134	5.04.916.111/2000	4 - 137	5.05.510.648/0000	2 - 75	5.05.800.030/0000	1 - 40
5.04.914.125/0100	4 - 134	5.04.916.112/2000	4 - 137	5.05.510.649/0000	2 - 75	5.05.800.030/0000	5 - 29
5.04.914.125/2000	4 - 134	5.04.916.113/2000	4 - 137	5.05.510.935/0000	2 - 146	5.05.800.041/0000	1 - 8
5.04.914.126/0100	4 - 134	5.04.916.114/2000	4 - 137	5.05.510.936/0000	2 - 146	5.05.800.041/0000	1 - 12
5.04.914.126/2000	4 - 134	5.04.916.115/2000	4 - 137	5.05.511.171/0209	4 - 155	5.05.800.041/0000	5 - 27
5.04.914.127/0100	4 - 134	5.04.916.116/2000	4 - 137	5.05.511.168/0209	4 - 165	5.05.800.042/0000	1 - 20
5.04.914.127/2000	4 - 134	5.04.916.117/2000	4 - 137	5.05.511.168/0754	4 - 155	5.05.800.042/0000	1 - 33
5.04.914.128/0100	4 - 134	5.04.916.118/2000	4 - 137	5.05.511.168/0754	4 - 165	5.05.800.042/0000	2 - 10
5.04.914.128/2000	4 - 134	5.04.916.119/2000	4 - 137	5.05.511.169/0209	4 - 165	5.05.800.042/0000	2 - 43
5.04.914.200/2000	4 - 128	5.04.916.120/2000	4 - 137	5.05.511.170/0209	4 - 165	5.05.800.042/0000	5 - 27
5.04.914.200/2000	4 - 129	5.04.916.121/2000	4 - 137	5.05.511.171/0209	4 - 165	5.05.800.049/0100	1 - 20
5.04.914.200/2000	4 - 139	5.04.916.122/2000	4 - 137	5.05.511.173/0209	4 - 165	5.05.800.049/0100	1 - 25
5.04.914.201/2000	4 - 130	5.04.916.123/2000	4 - 137	5.05.511.194/0000	2 - 147	5.05.800.049/0100	1 - 27
5.04.914.201/2000	4 - 139	5.04.916.124/1404	4 - 137	5.05.511.195/0000	2 - 147	5.05.800.049/0100	1 - 30
5.04.915.000/2000	4 - 133	5.04.916.124/2214	4 - 138	5.05.511.470/2200	4 - 19	5.05.800.049/0100	1 - 33
5.04.915.100/2000	4 - 125	5.04.916.125/2000	4 - 137	5.05.511.470/2300	4 - 19	5.05.800.049/0100	2 - 83
5.04.915.100/2000	4 - 134	5.04.916.126/2000	4 - 137	5.05.511.470/2400	4 - 19	5.05.800.049/0100	5 - 23
5.04.915.200/2000	4 - 139	5.04.916.127/2000	4 - 138	5.05.511.470/2500	4 - 19	5.05.800.050/0100	2 - 83
5.04.915.201/2000	4 - 128	5.04.916.128/2000	4 - 138	5.05.511.470/2600	4 - 19	5.05.800.050/0100	5 - 23
5.04.915.201/2000	4 - 139	5.04.916.129/2000	4 - 138	5.05.511.471/2200	4 - 19	5.05.800.051/0100	2 - 83
5.04.916.000/2000	4 - 135	5.04.916.130/2000	4 - 138	5.05.511.471/2300	4 - 19	5.05.800.051/0100	5 - 23
5.04.916.001/2000	4 - 135	5.04.916.131/2000	4 - 138	5.05.511.471/2400	4 - 19	5.05.800.055/0000	2 - 16
5.04.916.002/2000	4 - 135	5.04.916.132/2000	4 - 138	5.05.511.471/2500	4 - 19	5.05.800.055/0000	2 - 77
5.04.916.003/2000	4 - 135	5.04.916.133/2000	4 - 137	5.05.511.471/2600	4 - 19	5.05.800.062/0000	1 - 88
5.04.916.004/2000	4 - 135	5.04.916.134/2000	4 - 137	5.05.511.475/2200	4 - 20	5.05.800.062/0000	2 - 92
5.04.916.005/2000	4 - 135	5.04.916.201/1501	4 - 136	5.05.511.475/2300	4 - 20	5.05.800.062/0000	2 - 99
5.04.916.006/2000	4 - 135	5.04.916.202/1501	4 - 136	5.05.511.475/2400	4 - 20	5.05.800.062/0000	2 - 102
5.04.916.007/2000	4 - 135	5.04.916.203/1501	4 - 136	5.05.511.475/2500	4 - 20	5.05.800.062/0000	2 - 109
5.04.916.008/2000	4 - 135	5.04.916.223/1501	4 - 136	5.05.511.475/2600	4 - 20	5.05.800.062/0000	2 - 115
5.04.916.009/2000	4 - 135	5.04.916.224/1404	4 - 136	5.05.511.476/2200	4 - 20	5.05.800.062/0000	2 - 119
5.04.916.010/2000	4 - 135	5.04.916.224/2214	4 - 136	5.05.511.476/2300	4 - 20	5.05.800.062/0000	2 - 123
5.04.916.011/2000	4 - 135	5.04.916.227/1501	4 - 136	5.05.511.476/2400	4 - 20	5.05.800.062/0000	2 - 127
5.04.916.012/2000	4 - 135	5.04.916.228/1501	4 - 136	5.05.511.476/2500	4 - 20	5.05.800.062/0000	2 - 129
5.04.916.013/2000	4 - 135	5.04.916.231/1501	4 - 138	5.05.511.476/2600	4 - 20	5.05.800.062/0000	2 - 132
5.04.916.014/2000	4 - 135	5.04.916.232/1501	4 - 138	5.05.511.480/2200	4 - 20	5.05.800.062/0000	2 - 145
5.04.916.015/2000	4 - 135	5.04.916.233/1501	4 - 138	5.05.511.480/2300	4 - 20	5.05.800.062/0000	2 - 159
5.04.916.016/2000	4 - 136	5.04.916.253/1501	4 - 138	5.05.511.480/2400	4 - 20	5.05.800.062/0000	2 - 167
5.04.916.017/2000	4 - 136	5.04.916.254/1404	4 - 138	5.05.511.480/2500	4 - 20	5.05.800.062/0000	2 - 171
5.04.916.018/2000	4 - 136	5.04.916.254/2214	4 - 138	5.05.511.480/2600	4 - 20	5.05.800.062/0000	2 - 174
5.04.916.019/2000	4 - 136	5.04.916.257/1501	4 - 138	5.05.511.481/2200	4 - 20	5.05.800.062/0000	2 - 177
5.04.916.020/2000	4 - 136	5.04.916.258/1501	4 - 138	5.05.511.481/2300	4 - 20	5.05.800.062/0000	2 - 180
5.04.916.021/2000	4 - 135	5.05.004.901/0000	4 - 53	5.05.511.481/2400	4 - 20	5.05.800.062/0000	2 - 182
5.04.916.022/2000	4 - 135	5.05.004.902/0000	4 - 53	5.05.511.481/2500	4 - 20	5.05.800.062/0000	2 - 185
5.04.916.023/2000	4 - 135	5.05.004.903/0000	4 - 53	5.05.511.481/2600	4 - 20	5.05.800.062/0000	2 - 188
5.04.916.024/1404	4 - 135	5.05.005.175/2200	4 - 28	5.05.511.639/0000	4 - 16	5.05.800.062/0000	2 - 190
5.04.916.024/2214	4 - 136	5.05.005.176/2200	4 - 28	5.05.511.640/0000	4 - 16	5.05.800.062/0000	2 - 192
5.04.916.025/2000	4 - 135	5.05.005.177/2200	4 - 28	5.05.511.641/0000	4 - 16	5.05.800.062/0000	2 - 194
5.04.916.026/2000	4 - 135	5.05.005.178/2200	4 - 28	5.05.511.649/2200	4 - 24	5.05.800.062/0000	2 - 198
5.04.916.027/2000	4 - 136	5.05.005.182/2200	4 - 28	5.05.511.650/2200	4 - 24	5.05.800.062/0000	2 - 207
5.04.916.028/2000	4 - 136	5.05.200.008/0000	1 - 41	5.05.511.651/2200	4 - 24	5.05.800.062/0000	2 - 209
5.04.916.029/2000	4 - 136	5.05.200.008/0000	1 - 48	5.05.511.658/2200	4 - 24	5.05.800.062/0000	2 - 211
5.04.916.030/2000	4 - 136	5.05.200.008/0000	5 - 30	5.05.511.659/2200	4 - 24	5.05.800.062/0000	2 - 213
5.04.916.031/2000	4 - 136	5.05.200.009/0000	1 - 40	5.05.511.660/2200	4 - 24	5.05.800.062/0000	2 - 215
5.04.916.032/2000	4 - 136	5.05.200.009/0000	1 - 48	5.05.511.747/0200	2 - 262	5.05.800.062/0000	2 - 222
5.04.916.033/2000	4 - 135	5.05.200.009/0000	5 - 30	5.05.511.747/0300	2 - 262	5.05.800.062/0000	2 - 224
5.04.916.034/2000	4 - 135	5.05.200.025/0000	2 - 267	5.05.511.747/0400	2 - 262	5.05.800.062/0000	2 - 227

Order number	Page	Order number	Page	Order number	Page	Order number	Page
5.05.800.062/0000	2 - 229	5.30.759.028/0000	5 - 32	5.30.759.106/0000	5 - 33	5.46.001.057/0209	4 - 40
5.05.800.062/0000	2 - 230	5.30.759.029/0000	4 - 97	5.30.759.107/0000	4 - 98	5.46.001.057/0209	4 - 51
5.05.800.062/0000	2 - 232	5.30.759.029/0000	5 - 32	5.30.759.107/0000	5 - 33	5.46.001.058/0209	4 - 51
5.05.800.062/0000	2 - 261	5.30.759.030/0000	4 - 97	5.30.759.108/0000	4 - 98	5.46.001.059/0209	4 - 51
5.05.800.062/0000	5 - 25	5.30.759.030/0000	5 - 32	5.30.759.108/0000	5 - 33	5.46.001.060/0209	4 - 51
5.05.800.063/0000	2 - 83	5.30.759.031/0000	4 - 97	5.30.759.109/0000	4 - 98	5.46.001.063/0209	4 - 51
5.05.800.063/0000	5 - 23	5.30.759.031/0000	5 - 32	5.30.759.109/0000	5 - 33	5.46.001.064/0209	4 - 51
5.05.800.064/0000	2 - 147	5.30.759.032/0000	4 - 97	5.30.759.110/0000	4 - 98	5.46.001.103/0200	4 - 12
5.05.800.064/0000	5 - 24	5.30.759.032/0000	5 - 32	5.30.759.110/0000	5 - 33	5.46.001.104/0200	4 - 12
5.05.800.065/0000	2 - 147	5.30.759.033/0000	4 - 97	5.30.759.111/0000	4 - 98	5.46.001.105/0200	4 - 12
5.05.800.065/0000	5 - 24	5.30.759.033/0000	5 - 32	5.30.759.111/0000	5 - 33	5.46.001.106/0200	4 - 12
5.05.800.067/0000	2 - 267	5.30.759.034/0000	2 - 265	5.30.759.112/0000	4 - 98	5.46.001.107/0200	4 - 12
5.05.800.067/0000	5 - 24	5.30.759.034/0000	4 - 34	5.30.759.112/0000	5 - 33	5.46.001.108/0200	4 - 12
5.05.800.068/0000	2 - 267	5.30.759.034/0000	4 - 40	5.30.759.113/0000	4 - 98	5.46.001.121/0200	4 - 12
5.05.800.068/0000	5 - 24	5.30.759.034/0000	4 - 97	5.30.759.113/0000	5 - 33	5.46.001.122/0200	4 - 12
5.07.620.004/0000	1 - 20	5.30.759.034/0000	5 - 32	5.30.759.114/0000	4 - 98	5.46.001.123/0200	4 - 12
5.07.620.004/0000	1 - 25	5.30.759.035/0000	2 - 265	5.30.759.114/0000	5 - 33	5.46.001.124/0200	4 - 12
5.07.620.004/0000	1 - 27	5.30.759.035/0000	4 - 97	5.30.759.115/0000	4 - 98	5.46.001.125/0200	4 - 12
5.07.620.004/0000	1 - 30	5.30.759.035/0000	5 - 32	5.30.759.115/0000	5 - 33	5.46.001.126/0200	4 - 12
5.07.620.004/0000	1 - 33	5.30.759.036/0000	2 - 265	5.30.759.116/0000	4 - 98	5.46.001.127/0200	4 - 12
5.07.620.004/0000	2 - 30	5.30.759.036/0000	4 - 97	5.30.759.116/0000	5 - 33	5.46.001.128/0200	4 - 12
5.07.620.004/0000	2 - 80	5.30.759.036/0000	5 - 32	5.30.759.117/0000	4 - 98	5.46.001.141/0200	4 - 12
5.07.620.006/0000	2 - 80	5.30.759.037/0000	2 - 265	5.30.759.117/0000	5 - 33	5.46.001.142/0200	4 - 12
5.07.620.007/0000	2 - 81	5.30.759.037/0000	4 - 97	5.30.759.124/0000	4 - 98	5.46.001.143/0200	4 - 12
5.07.620.010/0000	2 - 92	5.30.759.037/0000	5 - 32	5.30.759.124/0000	5 - 33	5.46.001.144/0200	4 - 12
5.07.620.010/0000	2 - 93	5.30.759.038/0000	2 - 265	5.30.759.125/0000	4 - 98	5.46.001.145/0200	4 - 12
5.07.620.010/0000	2 - 94	5.30.759.038/0000	4 - 97	5.30.759.125/0000	5 - 33	5.46.001.146/0200	4 - 12
5.07.620.010/0000	2 - 100	5.30.759.038/0000	5 - 32	5.30.759.251/0000	4 - 97	5.46.001.147/0200	4 - 12
5.07.620.010/0000	2 - 103	5.30.759.039/0000	2 - 265	5.30.759.251/0000	5 - 32	5.46.001.148/0200	4 - 12
5.07.620.010/0000	2 - 104	5.30.759.039/0000	4 - 97	5.30.759.253/0000	4 - 98	5.46.001.163/0200	4 - 12
5.07.620.010/0000	2 - 111	5.30.759.039/0000	5 - 32	5.30.759.253/0000	5 - 33	5.46.001.164/0200	4 - 12
5.07.620.010/0000	2 - 145	5.30.759.040/0000	2 - 265	5.30.759.254/0000	4 - 98	5.46.001.165/0200	4 - 12
5.07.620.011/0000	2 - 95	5.30.759.040/0000	4 - 97	5.30.759.254/0000	5 - 33	5.46.001.166/0200	4 - 12
5.07.620.011/0000	2 - 96	5.30.759.040/0000	5 - 32	5.30.764.005/0000	4 - 119	5.46.001.167/0200	4 - 12
5.07.620.011/0000	2 - 97	5.30.759.041/0000	2 - 265	5.30.764.005/0000	5 - 34	5.46.001.168/0200	4 - 12
5.07.620.011/0000	2 - 100	5.30.759.041/0000	4 - 97	5.30.764.010/0000	4 - 119	5.46.001.183/0200	4 - 12
5.07.620.011/0000	2 - 106	5.30.759.041/0000	5 - 32	5.30.764.010/0000	5 - 34	5.46.001.184/0200	4 - 13
5.07.620.011/0000	2 - 107	5.30.759.042/0000	2 - 265	5.30.764.018/0000	4 - 119	5.46.001.185/0200	4 - 13
5.07.620.011/0000	2 - 113	5.30.759.042/0000	4 - 97	5.30.764.018/0000	5 - 34	5.46.001.186/0200	4 - 13
5.07.620.011/0000	2 - 145	5.30.759.042/0000	5 - 32	5.30.764.027/0000	4 - 119	5.46.001.187/0200	4 - 13
5.30.075.010/0100	3 - 25	5.30.759.043/0104	4 - 97	5.30.764.027/0000	5 - 34	5.46.001.188/0200	4 - 13
5.30.075.010/0100	5 - 30	5.30.759.043/0104	5 - 32	5.30.764.040/0000	4 - 119	5.46.011.028/0710	4 - 63
5.30.109.010/0756	4 - 63	5.30.759.094/0000	4 - 98	5.30.764.040/0000	5 - 34	5.46.011.028/0710	4 - 95
5.30.109.010/0756	4 - 99	5.30.759.094/0000	5 - 33	5.37.540.024/8622	2 - 76	5.46.011.030/0710	4 - 95
5.30.109.019/0105	4 - 99	5.30.759.095/0000	4 - 98	5.37.540.024/8622	2 - 262	5.46.011.036/0710	4 - 95
5.30.109.020/0756	2 - 263	5.30.759.095/0000	5 - 33	5.37.540.024/8622	5 - 27	5.46.011.037/0710	4 - 95
5.30.120.009/0100	5 - 31	5.30.759.096/0000	4 - 98	5.37.540.029/6000	2 - 76	5.46.011.038/0710	4 - 95
5.30.120.015/0100	4 - 173	5.30.759.096/0000	5 - 33	5.37.540.029/6000	5 - 27	5.46.017.028/0710	4 - 63
5.30.120.015/0100	4 - 177	5.30.759.097/0000	4 - 98	5.37.700.124/0000	1 - 8	5.46.017.028/0710	4 - 96
5.30.120.015/0100	4 - 180	5.30.759.097/0000	5 - 33	5.37.700.124/0000	1 - 12	5.46.017.029/0710	4 - 63
5.30.120.015/0100	5 - 31	5.30.759.098/0000	4 - 98	5.37.700.124/0000	1 - 20	5.46.017.030/0710	4 - 96
5.30.125.003/0100	5 - 31	5.30.759.098/0000	5 - 33	5.37.700.124/0000	1 - 25	5.46.017.036/0710	4 - 96
5.30.125.007/0100	4 - 74	5.30.759.099/0000	4 - 98	5.37.700.124/0000	1 - 27	5.46.017.037/0710	4 - 96
5.30.125.007/0100	4 - 87	5.30.759.099/0000	5 - 33	5.37.700.124/0000	1 - 30	5.46.017.038/0710	4 - 96
5.30.125.007/0100	5 - 31	5.30.759.100/0000	4 - 98	5.37.700.124/0000	1 - 33	5.46.167.043/0209	4 - 50
5.30.163.021/6000	4 - 142	5.30.759.100/0000	5 - 33	5.37.700.124/0000	5 - 28	5.46.167.047/0209	4 - 50
5.30.163.024/6000	4 - 142	5.30.759.101/0000	4 - 98	5.40.451.283/0000	2 - 79	5.46.167.050/0209	4 - 50
5.30.729.009/0000	4 - 104	5.30.759.101/0000	5 - 33	5.40.451.283/0000	2 - 148	5.46.167.058/0209	4 - 50
5.30.759.023/0000	4 - 97	5.30.759.102/0000	4 - 98	5.40.451.283/0000	5 - 20	5.46.167.059/0209	4 - 50
5.30.759.023/0000	5 - 32	5.30.759.102/0000	5 - 33	5.41.032.173/7500	4 - 142	5.46.167.060/0209	4 - 50
5.30.759.025/0000	4 - 97	5.30.759.103/0000	4 - 98	5.45.201.556/0700	2 - 222	5.46.167.061/0209	4 - 50
5.30.759.025/0000	5 - 32	5.30.759.103/0000	5 - 33	5.45.201.556/0700	2 - 224	5.46.167.064/0209	4 - 50
5.30.759.026/0000	4 - 97	5.30.759.104/0000	4 - 98	5.45.201.556/0700	2 - 227	5.46.167.067/0209	4 - 50
5.30.759.026/0000	5 - 32	5.30.759.104/0000	5 - 33	5.45.201.556/0700	2 - 229	5.46.167.090/0209	4 - 49
5.30.759.027/0000	4 - 97	5.30.759.105/0000	4 - 98	5.45.201.556/0700	2 - 231	5.46.167.091/0209	4 - 49
5.30.759.027/0000	5 - 32	5.30.759.105/0000	5 - 33	5.45.201.556/0700	2 - 232	5.46.167.092/0209	4 - 49
5.30.759.028/0000	4 - 97	5.30.759.106/0000	4 - 98	5.45.201.556/0700	2 - 267	5.46.167.094/0209	4 - 49

APPENDIX

REFERENCE NUMBER GUIDE

Order number	Page	Order number	Page	Order number	Page	Order number	Page
5.46.167.096/0209	4 - 49	5.46.681.004/0514	4 - 114	5.49.077.011/1002	2 - 60	5.49.257.011/1402	1 - 46
5.46.167.099/0209	4 - 49	5.46.681.004/0611	4 - 114	5.49.077.011/1306	1 - 21	5.49.257.011/1503	1 - 39
5.46.167.101/0209	4 - 49	5.46.681.004/0700	4 - 114	5.49.077.011/1306	1 - 22	5.49.257.011/1503	1 - 46
5.46.167.102/0209	4 - 49	5.46.681.021/1002	4 - 112	5.49.077.011/1306	2 - 10	5.49.259.013/1002	1 - 53
5.46.167.106/0209	4 - 49	5.46.681.021/1307	4 - 112	5.49.077.011/1306	2 - 12	5.49.259.013/1002	1 - 54
5.46.167.107/0209	4 - 49	5.46.681.021/1403	4 - 112	5.49.077.011/1306	2 - 16	5.49.259.013/1002	1 - 58
5.46.167.227/0209	4 - 50	5.46.681.021/1510	4 - 112	5.49.077.011/1306	2 - 40	5.49.259.013/1002	1 - 59
5.46.167.301/0209	4 - 49	5.46.681.022/1002	4 - 113	5.49.077.011/1306	2 - 44	5.49.259.013/1301	1 - 53
5.46.167.311/0209	4 - 34	5.46.681.022/1307	4 - 113	5.49.077.011/1306	2 - 60	5.49.259.013/1301	1 - 54
5.46.167.311/0209	4 - 49	5.46.681.022/1403	4 - 113	5.49.077.011/1403	1 - 21	5.49.259.013/1301	1 - 58
5.46.168.043/0209	4 - 50	5.46.681.022/1510	4 - 113	5.49.077.011/1403	1 - 22	5.49.259.013/1301	1 - 59
5.46.168.044/0209	4 - 50	5.46.681.023/1002	4 - 113	5.49.077.011/1403	2 - 10	5.49.259.013/1402	1 - 53
5.46.168.047/0209	4 - 50	5.46.681.023/1307	4 - 113	5.49.077.011/1403	2 - 12	5.49.259.013/1402	1 - 54
5.46.168.050/0209	4 - 40	5.46.681.023/1403	4 - 113	5.49.077.011/1403	2 - 16	5.49.259.013/1402	1 - 58
5.46.168.050/0209	4 - 50	5.46.681.023/1510	4 - 113	5.49.077.011/1403	2 - 40	5.49.259.013/1402	1 - 59
5.46.168.058/0209	4 - 50	5.46.681.024/1002	4 - 114	5.49.077.011/1403	2 - 44	5.49.259.013/1503	1 - 53
5.46.168.059/0209	4 - 50	5.46.681.024/1307	4 - 114	5.49.077.011/1403	2 - 60	5.49.259.013/1503	1 - 54
5.46.168.060/0209	4 - 50	5.46.681.024/1403	4 - 114	5.49.077.011/1505	1 - 21	5.49.259.013/1503	1 - 58
5.46.168.061/0209	4 - 50	5.46.681.024/1510	4 - 114	5.49.077.011/1505	1 - 22	5.49.259.013/1503	1 - 59
5.46.168.064/0209	4 - 50	5.49.075.015/1002	1 - 9	5.49.077.011/1505	2 - 10	5.49.259.017/0104	2 - 13
5.46.168.067/0209	4 - 50	5.49.075.015/1002	1 - 13	5.49.077.011/1505	2 - 12	5.49.259.017/0200	2 - 13
5.46.168.227/0209	4 - 50	5.49.075.015/1306	1 - 9	5.49.077.011/1505	2 - 16	5.49.259.017/0313	2 - 13
5.46.169.047/0209	4 - 50	5.49.075.015/1306	1 - 13	5.49.077.011/1505	2 - 40	5.49.259.017/0410	2 - 13
5.46.169.050/0209	4 - 50	5.49.075.015/1403	1 - 9	5.49.077.011/1505	2 - 44	5.49.259.017/0500	2 - 13
5.46.169.058/0209	4 - 50	5.49.075.015/1403	1 - 13	5.49.077.011/1505	2 - 60	5.49.259.017/0612	2 - 13
5.46.169.059/0209	4 - 50	5.49.075.015/1505	1 - 9	5.49.077.011/1607	1 - 21	5.49.259.017/1002	2 - 13
5.46.169.060/0209	4 - 50	5.49.075.015/1505	1 - 13	5.49.077.011/1607	1 - 22	5.49.259.017/1002	2 - 15
5.46.169.061/0209	4 - 50	5.49.075.015/1607	1 - 9	5.49.077.011/1607	2 - 10	5.49.259.017/1002	2 - 45
5.46.169.064/0209	4 - 50	5.49.075.015/1607	1 - 13	5.49.077.011/1607	2 - 12	5.49.259.017/1002	2 - 61
5.46.169.067/0209	4 - 50	5.49.075.016/1002	1 - 9	5.49.077.011/1607	2 - 16	5.49.259.017/1306	2 - 13
5.46.500.001/4010	4 - 116	5.49.075.016/1002	1 - 12	5.49.077.011/1607	2 - 40	5.49.259.017/1306	2 - 15
5.46.500.003/4010	4 - 116	5.49.075.016/1306	1 - 9	5.49.077.011/1607	2 - 44	5.49.259.017/1306	2 - 45
5.46.500.004/4010	4 - 117	5.49.075.016/1306	1 - 12	5.49.077.011/1607	2 - 60	5.49.259.017/1306	2 - 60
5.46.651.015/0309	4 - 110	5.49.075.016/1403	1 - 9	5.49.077.012/1002	1 - 22	5.49.259.017/1403	2 - 13
5.46.651.015/0409	4 - 110	5.49.075.016/1403	1 - 12	5.49.077.012/1002	1 - 23	5.49.259.017/1403	2 - 15
5.46.651.015/0514	4 - 110	5.49.075.016/1505	1 - 9	5.49.077.012/1002	2 - 11	5.49.259.017/1403	2 - 45
5.46.651.015/0611	4 - 110	5.49.075.016/1505	1 - 12	5.49.077.012/1306	1 - 22	5.49.259.017/1403	2 - 60
5.46.651.015/0700	4 - 110	5.49.075.016/1607	1 - 9	5.49.077.012/1306	1 - 23	5.49.259.017/1505	2 - 13
5.46.651.019/1002	4 - 110	5.49.075.016/1607	1 - 12	5.49.077.012/1306	2 - 11	5.49.259.017/1505	2 - 15
5.46.651.019/1307	4 - 110	5.49.075.017/1002	1 - 10	5.49.077.012/1403	1 - 22	5.49.259.017/1505	2 - 45
5.46.651.019/1403	4 - 110	5.49.075.017/1002	1 - 13	5.49.077.012/1403	1 - 23	5.49.259.017/1505	2 - 60
5.46.651.019/1510	4 - 110	5.49.075.017/1306	1 - 10	5.49.077.012/1403	2 - 11	5.49.259.017/1607	2 - 13
5.46.654.059/0227	4 - 96	5.49.075.017/1306	1 - 14	5.49.077.012/1505	1 - 22	5.49.259.017/1607	2 - 15
5.46.654.192/0200	4 - 53	5.49.075.017/1403	1 - 10	5.49.077.012/1505	1 - 23	5.49.259.017/1607	2 - 45
5.46.654.192/0300	4 - 53	5.49.075.017/1403	1 - 14	5.49.077.012/1505	2 - 11	5.49.259.017/1607	2 - 61
5.46.654.192/0400	4 - 53	5.49.075.017/1505	1 - 10	5.49.077.012/1607	1 - 22	5.49.259.018/1002	2 - 14
5.46.654.192/0500	4 - 53	5.49.075.017/1505	1 - 14	5.49.077.012/1607	1 - 23	5.49.259.018/1306	2 - 14
5.46.654.192/0600	4 - 53	5.49.075.017/1607	1 - 10	5.49.077.012/1607	2 - 11	5.49.259.018/1403	2 - 14
5.46.654.192/0700	4 - 53	5.49.075.017/1607	1 - 14	5.49.077.014/1002	1 - 33	5.49.259.018/1505	2 - 14
5.46.654.192/6032	4 - 53	5.49.077.011/0104	2 - 10	5.49.077.014/1002	1 - 34	5.49.259.018/1607	2 - 14
5.46.654.192/6033	4 - 53	5.49.077.011/0104	2 - 16	5.49.077.014/1306	1 - 33	5.49.263.006/1002	2 - 40
5.46.657.442/0100	2 - 11	5.49.077.011/0200	2 - 10	5.49.077.014/1306	1 - 34	5.49.263.006/1306	2 - 40
5.46.657.442/0300	2 - 11	5.49.077.011/0200	2 - 16	5.49.077.014/1403	1 - 33	5.49.263.006/1403	2 - 40
5.46.681.001/0309	4 - 112	5.49.077.011/0313	2 - 10	5.49.077.014/1403	1 - 34	5.49.263.006/1505	2 - 40
5.46.681.001/0409	4 - 112	5.49.077.011/0313	2 - 16	5.49.077.014/1505	1 - 33	5.49.263.006/1607	2 - 40
5.46.681.001/0514	4 - 112	5.49.077.011/0410	2 - 10	5.49.077.014/1505	1 - 34	5.49.263.007/1002	2 - 41
5.46.681.001/0611	4 - 112	5.49.077.011/0410	2 - 16	5.49.077.014/1607	1 - 33	5.49.263.007/1306	2 - 41
5.46.681.001/0700	4 - 112	5.49.077.011/0518	2 - 10	5.49.077.014/1607	1 - 34	5.49.263.007/1403	2 - 41
5.46.681.002/0309	4 - 112	5.49.077.011/0518	2 - 16	5.49.205.008/1002	1 - 86	5.49.263.007/1505	2 - 41
5.46.681.002/0700	4 - 113	5.49.077.011/0612	2 - 10	5.49.205.008/1303	1 - 86	5.49.263.062/1000	2 - 168
5.46.681.003/0309	4 - 113	5.49.077.011/0612	2 - 16	5.49.205.008/1402	1 - 86	5.49.263.062/1000	2 - 225
5.46.681.003/0409	4 - 113	5.49.077.011/1002	1 - 21	5.49.205.008/1502	1 - 86	5.49.263.062/1300	2 - 168
5.46.681.003/0514	4 - 113	5.49.077.011/1002	2 - 10	5.49.257.011/1002	1 - 39	5.49.263.062/1300	2 - 169
5.46.681.003/0611	4 - 113	5.49.077.011/1002	2 - 12	5.49.257.011/1002	1 - 46	5.49.263.062/1300	2 - 225
5.46.681.003/0700	4 - 113	5.49.077.011/1002	2 - 16	5.49.257.011/1301	1 - 39	5.49.263.062/1400	2 - 168
5.46.681.004/0309	4 - 114	5.49.077.011/1002	2 - 40	5.49.257.011/1301	1 - 46	5.49.263.062/1400	2 - 169
5.46.681.004/0409	4 - 114	5.49.077.011/1002	2 - 44	5.49.257.011/1402	1 - 39	5.49.263.062/1400	2 - 225

Order number	Page	Order number	Page	Order number	Page	Order number	Page
5.49.263.062/1500	2 - 168	5.52.008.065/0000	1 - 84	5.58.002.034/0000	2 - 48	5.73.013.000/0214	1 - 48
5.49.263.062/1500	2 - 169	5.52.008.065/0000	1 - 86	5.58.002.034/0000	2 - 53	5.73.110.000/0000	2 - 146
5.49.263.062/1500	2 - 225	5.52.008.101/0100	1 - 81	5.58.002.034/0000	2 - 57	5.73.110.004/0000	2 - 146
5.49.263.062/1600	2 - 168	5.52.008.101/0300	1 - 82	5.58.002.034/0000	2 - 59	5.73.110.005/0000	2 - 146
5.49.263.062/1600	2 - 169	5.52.008.115/0000	1 - 80	5.58.002.034/0000	2 - 78	5.73.110.021/0000	2 - 146
5.49.263.062/1600	2 - 225	5.52.011.026/0100	1 - 82	5.58.002.034/0000	5 - 26	5.73.110.022/0000	2 - 146
5.49.275.032/1002	1 - 41	5.52.011.027/0100	3 - 23	5.58.004.721/0000	1 - 43	5.73.110.023/0000	2 - 146
5.49.275.032/1002	1 - 48	5.52.011.028/0100	1 - 84	5.58.006.801/0000	4 - 178	5.73.110.026/0000	2 - 146
5.49.275.032/1301	1 - 41	5.52.011.029/0100	3 - 25	5.58.007.001/0000	2 - 22	5.73.110.027/0000	2 - 146
5.49.275.032/1301	1 - 48	5.52.011.030/0100	1 - 86	5.58.007.001/0000	2 - 53	5.73.110.028/0000	2 - 146
5.49.275.032/1402	1 - 41	5.55.101.715/0200	1 - 82	5.58.007.001/0000	2 - 177	5.73.110.029/0000	2 - 146
5.49.275.032/1402	1 - 48	5.55.101.715/0200	5 - 31	5.58.007.001/0000	4 - 174	5.73.111.000/0000	1 - 20
5.49.275.032/1503	1 - 41	5.55.103.030/1013	4 - 40	5.58.008.001/0000	2 - 22	5.73.111.000/0000	1 - 27
5.49.275.032/1503	1 - 48	5.55.103.030/1013	4 - 112	5.58.008.001/0000	2 - 53	5.73.111.000/0000	1 - 30
5.49.275.036/1002	1 - 40	5.55.103.031/1013	4 - 112	5.58.008.001/0000	2 - 177	5.73.111.000/0000	1 - 33
5.49.275.036/1002	1 - 47	5.55.103.032/1013	4 - 113	5.58.008.001/0000	4 - 174	5.73.111.000/0000	2 - 80
5.49.275.036/1301	1 - 40	5.55.103.077/1013	4 - 114	5.58.009.001/0100	4 - 174	5.73.112.000/0000	2 - 81
5.49.275.036/1301	1 - 47	5.55.103.079/0152	4 - 118	5.58.010.001/0100	4 - 174	5.76.204.101/0400	2 - 82
5.49.275.036/1402	1 - 40	5.55.103.079/0700	4 - 118	5.58.011.001/0000	1 - 66	5.76.204.101/0400	2 - 149
5.49.275.036/1402	1 - 47	5.55.103.105/0100	2 - 77	5.58.015.201/0000	1 - 27	5.76.204.101/0400	2 - 264
5.49.275.036/1503	1 - 40	5.55.103.265/1013	4 - 34	5.58.017.001/0000	2 - 109	5.76.204.101/0400	5 - 22
5.49.275.036/1503	1 - 47	5.55.103.265/1013	4 - 110	5.58.017.001/0000	2 - 121	5.76.204.102/0400	2 - 82
5.49.277.052/1002	1 - 54	5.55.104.208/0459	4 - 142	5.58.017.403/0000	2 - 109	5.76.204.102/0400	2 - 149
5.49.277.052/1002	1 - 55	5.55.105.454/0111	2 - 180	5.58.017.403/0000	2 - 121	5.76.204.102/0400	2 - 264
5.49.277.052/1002	1 - 60	5.55.105.454/0111	2 - 229	5.58.017.421/0000	2 - 109	5.76.204.102/0400	5 - 22
5.49.277.052/1002	1 - 61	5.55.105.454/0111	2 - 267	5.58.017.421/0000	2 - 121	5.76.204.103/0400	2 - 82
5.49.277.052/1301	1 - 54	5.58.002.017/0105	1 - 84	5.58.018.001/0000	2 - 180	5.76.204.103/0400	2 - 149
5.49.277.052/1301	1 - 55	5.58.002.017/0105	5 - 25	5.58.099.010/0000	1 - 69	5.76.204.103/0400	2 - 264
5.49.277.052/1301	1 - 60	5.58.002.018/0105	1 - 86	5.58.099.011/0000	1 - 69	5.76.204.103/0400	5 - 22
5.49.277.052/1301	1 - 61	5.58.002.018/0105	3 - 25	5.58.099.012/0000	4 - 180	5.76.204.106/0400	2 - 81
5.49.277.052/1402	1 - 54	5.58.002.018/0105	5 - 25	5.58.099.013/0000	4 - 180	5.76.204.106/0400	5 - 21
5.49.277.052/1402	1 - 55	5.58.002.019/0105	1 - 20	5.70.059.000/2000	1 - 53	5.76.204.107/0400	2 - 82
5.49.277.052/1402	1 - 60	5.58.002.019/0105	1 - 25	5.70.059.000/2000	1 - 54	5.76.204.107/0400	2 - 149
5.49.277.052/1402	1 - 61	5.58.002.019/0105	1 - 27	5.70.059.000/2000	1 - 58	5.76.204.107/0400	2 - 264
5.49.277.052/1503	1 - 54	5.58.002.019/0105	1 - 30	5.70.059.000/2000	1 - 59	5.76.204.107/0400	5 - 22
5.49.277.052/1503	1 - 55	5.58.002.019/0105	1 - 33	5.70.629.000/2000	1 - 54	5.76.204.108/0400	2 - 81
5.49.277.052/1503	1 - 60	5.58.002.019/0105	1 - 38	5.70.629.000/2000	1 - 55	5.76.204.108/0400	5 - 21
5.49.277.052/1503	1 - 61	5.58.002.019/0105	1 - 43	5.70.629.000/2000	1 - 60	5.76.204.109/0400	2 - 82
5.49.277.058/1002	1 - 56	5.58.002.019/0105	1 - 46	5.70.629.000/2000	1 - 61	5.76.204.109/0400	2 - 149
5.49.277.058/1002	1 - 60	5.58.002.019/0105	1 - 52	5.70.630.000/2000	1 - 56	5.76.204.109/0400	2 - 264
5.49.277.058/1301	1 - 56	5.58.002.019/0105	1 - 58	5.70.630.000/2000	1 - 60	5.76.204.109/0400	5 - 22
5.49.277.058/1301	1 - 60	5.58.002.019/0105	1 - 66	5.70.635.000/2000	1 - 20	5.76.204.110/0400	2 - 82
5.49.277.058/1402	1 - 56	5.58.002.019/0105	1 - 69	5.70.635.000/2000	1 - 33	5.76.204.110/0400	5 - 21
5.49.277.058/1402	1 - 60	5.58.002.019/0105	1 - 80	5.70.635.000/2000	2 - 10	5.76.204.111/0400	2 - 82
5.49.277.058/1503	1 - 56	5.58.002.019/0105	1 - 82	5.70.635.000/2000	2 - 11	5.76.204.111/0400	2 - 149
5.49.277.058/1503	1 - 60	5.58.002.019/0105	3 - 18	5.70.635.000/2000	2 - 12	5.76.204.111/0400	2 - 264
5.50.240.063/0209	3 - 25	5.58.002.019/0105	3 - 20	5.70.635.000/2000	2 - 16	5.76.204.111/0400	5 - 22
5.50.240.063/0209	5 - 31	5.58.002.019/0105	5 - 25	5.70.635.000/2000	2 - 41	5.76.204.112/0400	2 - 82
5.50.240.065/0200	5 - 31	5.58.002.020/0105	3 - 27	5.70.635.000/2000	2 - 44	5.76.204.112/0400	5 - 21
5.52.006.020/0103	1 - 38	5.58.002.020/0105	5 - 25	5.70.635.000/2000	2 - 59	5.76.204.113/0400	2 - 82
5.52.006.020/0103	1 - 46	5.58.002.025/0105	1 - 76	5.70.635.000/2000	2 - 60	5.76.204.113/0400	2 - 149
5.52.006.020/0103	1 - 52	5.58.002.025/0105	1 - 78	5.70.637.000/2000	2 - 13	5.76.204.113/0400	2 - 264
5.52.006.020/0103	1 - 58	5.58.002.025/0105	3 - 11	5.70.637.000/2000	2 - 14	5.76.204.113/0400	5 - 22
5.52.006.020/0103	5 - 22	5.58.002.025/0105	5 - 25	5.70.637.000/2000	2 - 15	5.76.204.114/0400	2 - 81
5.52.006.021/0100	1 - 38	5.58.002.026/0105	3 - 16	5.70.637.000/2000	2 - 45	5.76.204.114/0400	5 - 21
5.52.006.021/0100	1 - 43	5.58.002.026/0105	5 - 25	5.70.637.000/2000	2 - 46	5.76.204.115/0400	2 - 82
5.52.006.021/0100	1 - 46	5.58.002.027/7705	5 - 25	5.70.800.200/0000	2 - 168	5.76.204.115/0400	2 - 149
5.52.006.021/0100	1 - 52	5.58.002.030/0000	1 - 43	5.70.800.200/0000	2 - 169	5.76.204.115/0400	2 - 264
5.52.006.021/0100	1 - 58	5.58.002.034/0000	2 - 10	5.70.800.200/0000	2 - 225	5.76.204.115/0400	5 - 21
5.52.006.021/0100	5 - 22	5.58.002.034/0000	2 - 17	5.70.803.000/2000	2 - 132	5.76.204.116/0400	2 - 81
5.52.006.022/0100	1 - 38	5.58.002.034/0000	2 - 25	5.70.803.000/2000	2 - 134	5.76.204.116/0400	5 - 21
5.52.006.022/0100	1 - 43	5.58.002.034/0000	2 - 28	5.72.050.000/0214	1 - 39	5.76.204.117/0400	2 - 82
5.52.006.022/0100	1 - 46	5.58.002.034/0000	2 - 30	5.72.050.000/0214	1 - 46	5.76.204.117/0400	2 - 149
5.52.006.022/0100	1 - 52	5.58.002.034/0000	2 - 33	5.73.012.000/0214	1 - 41	5.76.204.117/0400	2 - 264
5.52.006.022/0100	1 - 58	5.58.002.034/0000	2 - 36	5.73.012.000/0214	1 - 48	5.76.204.117/0400	5 - 21
5.52.006.022/0100	5 - 22	5.58.002.034/0000	2 - 39	5.73.013.000/0214	1 - 40	5.76.204.118/0400	2 - 81
5.52.008.061/0100	1 - 83	5.58.002.034/0000	2 - 44	5.73.013.000/0214	1 - 47	5.76.204.118/0400	5 - 21

APPENDIX

REFERENCE NUMBER GUIDE

Order number	Page
5.76.204.119/0400	2 - 82
5.76.204.119/0400	2 - 149
5.76.204.119/0400	2 - 264
5.76.204.119/0400	5 - 22
5.76.204.120/0400	2 - 81
5.76.204.120/0400	5 - 21
5.76.204.121/0400	2 - 82
5.76.204.121/0400	2 - 149
5.76.204.121/0400	2 - 264
5.76.204.121/0400	5 - 22
5.76.204.400/0400	2 - 81
5.76.204.400/0400	5 - 21
5.76.204.401/0400	2 - 81
5.76.204.401/0400	5 - 21
5.76.204.403/0400	2 - 81
5.76.204.403/0400	5 - 21
5.76.204.425/0400	1 - 30
5.76.204.426/0400	1 - 30
5.76.204.427/0400	1 - 30
5.76.204.428/0400	1 - 30
5.76.204.429/0400	1 - 30
5.76.205.011/0400	2 - 82
5.76.205.011/0400	2 - 149
5.76.205.011/0400	2 - 264
5.76.205.011/0400	5 - 21
5.76.207.001/0400	2 - 82
5.76.207.001/0400	2 - 149
5.76.207.001/0400	2 - 264
5.76.207.001/0400	5 - 22
5.76.207.002/0400	2 - 82
5.76.207.002/0400	2 - 149
5.76.207.002/0400	2 - 264
5.76.207.002/0400	5 - 22
5.80.000.000/0152	4 - 162
5.80.000.000/0242	4 - 162
5.82.000.000/0152	4 - 161
5.82.000.000/0242	4 - 161
5.82.110.000/0152	4 - 163
5.82.110.000/0242	4 - 163
5.92.025.368/0000	1 - 8
5.92.025.368/0000	1 - 12
5.92.025.368/0000	1 - 20
5.92.025.368/0000	1 - 25
5.92.025.368/0000	1 - 27
5.92.025.368/0000	1 - 30
5.92.025.368/0000	1 - 33
5.92.025.368/0000	5 - 28
7.16.102.006/0000	4 - 119

X-ON Electronics

Largest Supplier of Electrical and Electronic Components

Click to view similar products for [Keylock Switches](#) category:

Click to view products by [C&K](#) manufacturer:

Other Similar products are found below :

[89496-09](#) [58J1007](#) [58J8A45-01B05N](#) [719-0201-000](#) [719-0202-000](#) [719-0702-000](#) [719-5504-000](#) [84800-04](#) [GKNC33L](#) [GKNC3L](#)
[PVA2OAH5](#) [HA1K-2C2VA-2](#) [14-235.022K](#) [AS6H-2K2A](#) [AS6M-2K1B](#) [AS6Q-2K2A](#) [AS6Q-3K2A](#) [1571487-1](#) [KEY-AS6](#) [KH3C-20C](#)
[8928K493](#) [2SWK131AL102](#) [AS6M-2K1A](#) [AS6Q-2K1PB](#) [51-401.036D](#) [51-414.036D](#) [HW1K-31BF20](#) [HW1K-3HF20](#) [Y1112-2027CLFT](#)
[51-378.AD](#) [51-404.036D](#) [51-405.036D](#) [1-1437597-8](#) [58J8A36-01B04N](#) [58M1422](#) [86945-05](#) [719-0204-000](#) [719-0205-000](#) [719-0801-000](#)
[719-0804-000](#) [719-0805-000](#) [88422-18](#) [58J8A90-01B02N](#) [58J8A90-01C02N](#) [58J9P36-01B09N](#) [58J8A36-01C03N](#) [GKRA3K1A2-F03-C](#)
[GKBB14L6](#) [14-236.025K1020](#) [GKFE16LXA2](#)