

# 3401-031 Microminiature MTB1

## Features/Benefits

- **Non-magnetic**
- **Non-outgassing**
- **High performance Micropin™ contact system (“twist pin” spring male contact and tubular socket contact)**
- **Single-in-line strip Insulator (no metal shell): 2 to 81 cavities**
- **Shell Size described by the total number of insulator cavities**
- **Contact centers: 1,27 (.050)**
- **Suitable for Board-to Board, Board-to Cable, or Cable-to Cable applications**
- **Non removable crimp type contacts**
- **The Connectors are supplied with the Terminations or Cables installed in factory**



## Typical Applications

- **Payloads Board to board connexion**
- **Antenna connexions and harnesses**

High performance Microminiature connectors, ESA qualified, for space applications.

Space/High reliability MTB1 connectors meet stringent tests for outgassing and residual magnetism and are suitable for use in space, medical, and high performance military/aerospace applications.

MTB1 connectors meet the performance of the ESCC 3401 Generic Specification and the dimensional requirements of the ESCC 3401/031 Detail Specification.

## Materials and Finishes

Insulators	Diallylphthalate thermoset material, UL 94-V0, glass filled, dark green color
Female contacts	Copper alloy / Finish: 1,27 $\mu\text{m}$ (50 $\mu\text{in}$ ) min. Gold over Copper underlay
Male contacts	Copper alloy / Finish: 1,27 $\mu\text{m}$ (50 $\mu\text{in}$ ) min. Gold over Copper underlay
Guide posts and polarization keys	Stainless Steel type 303, passivated
Female latches	Stainless Steel type 303, passivated
Male latches	Stainless Steel type 303, passivated
Encapsulant	Epoxy
Uninsulated rigid Wire	Copper / Finish: 1,27 $\mu\text{m}$ (50 $\mu\text{in}$ ) min. Gold over 2,54 (100 $\mu\text{in}$ ) min. Silver underlay
ESCC 3901/013 Cables	Copper alloy / Finish 2,00 $\mu\text{m}$ (79 $\mu\text{in}$ ) min. Silver / Extruded PTFE Insulation
MIL-W-16878/4 Cables	Copper alloy / Finish Silver coating / Extruded PTFE Insulation



Dimensions are shown in mm (inch)  
Dimensions subject to change

# 3401-031 Microminiature MTB1

## Quality Levels

### ESA/ESCC Quality Level.

The Dole plant (France) is qualified by ESA for the supply of Microminiature connectors Type MTB1, according to the ESCC Generic Specification N° 3401, and to the applicable ESCC Detail Specification n° 3401/031.

First qualification obtained in 1986 (renewed every 2 years).  
Qualification certificate: 141 (MTB1).

Applications: Flight equipments, satellites, launchers (ESA requirements).

### FR022 Quality Level.

“Commercial Space Grade”.

C&K Connector Specification CS FR022, amendment to the ESCC Generic Specification n° 3401, for low cost products manufactured:

- in the same ESA qualified site
- through the same manufacturing and control processes
- with the same piece parts
- with lighter controls, documentation and traceability

Applications: Engineering models, ground equipments, testing, some flight equipments (no need for high requirements).

The connectors and accessories, supplied according to these 2 quality levels, are totally compatible, interchangeable, and intermateable, as they are manufactured with the same piece parts (except the cables), in the same ESA qualified site.

## Connector Styles

Description of the 3 Connector Styles proposed for the Space applications (Combinations of Configurations and Quality Levels).

Connector Style	Configuration	Quality Level
Space ESA	ESA	ESA
Space FR022	ESA	FR022
Standard FR022	Standard	FR022

Configuration characteristics.

Accessories	Configuration ESA	Configuration Space FR022	Configuration Standard FR022
Cavity filled with epoxy	1 & N (mandatory)	1 & N (mandatory)	N.A
Guide Posts	2 & N-1 (mandatory)	2 & N-1 (mandatory)	1 & N (option)
Polarization key	3 to N-2 (option)	3 to N-2 (option)	1 to N (option)
Latching (even number of cavities)	N/2 (option)	N/2 (option)	N/2 (option)
Latching (odd number of cavities)	N/2 – 1 (option)	N/2 – 1 (option)	N/2 – 1 (option)
Quality level	ESA	FR022	FR022



*Dimensions are shown in mm (inch)  
Dimensions subject to change*

# 3401-031 Microminiature MTB

## Performance Specifications

Operating Temperature range	-55°C / +125°C (-67°F / +257°F)			
Storage Temperature range	-55°C / +125°C (-67°F / +257°F)			
Working Voltage (between contacts and contact and shell)	<u>Sea level</u> 150 Vrms	<u>33000 m (108240 feet) altitude</u> 100 Vrms		
Rated Current	<u>Solid uninsulated Wire</u> 2,5 A max.	<u>AWG 26 Wire</u> 2,5 A max.	<u>AWG 28 Wire</u> 1,5 A max.	
Insulation Resistance (500 V DC)	5000 MΩ min.			
Voltage Proof	600 Vrms / 2.0 mA max. leakage current			
Contact Retention in insert	22,25 N max. / No contact axial displacement allowed			
Engagement / Separation Forces (Male Contacts)	<u>Gauge Fixture</u>	<u>Inner diameter</u> min. / max.	<u>Separation Force (N min.)</u>	<u>Engagement Force (N max.)</u>
	Max.	0,559 (.0220) / 0,564 (.0222)		1,667
	Min.	0,582 (.0229) / 0,587 (.0231)	0,137	
Mating / Unmating Forces (per contact)	Mating: 2.2 N max. Unmating: 0.14 N min. / 2.2 N max.			
Mechanical Endurance	500 cycles mating/unmating			
Contact Resistance	Low level current (10 mA / 20 mV DC): 6.0 mΩ max. Rated current: 5.0 mΩ max.			
Maximum Rated Current	<u>Nb of Contacts per Connector</u>	<u>Solid uninsulated Wire</u>	<u>AWG 26 Wire</u>	<u>AWG 28 Wire</u>
	2 to 4	2,0 A max.	2,0 A max.	1,4 A max.
	5 to 14	1,8 A max.	1,8 A max.	1,2 A max.
	15 and over	1,4 A max.	1,4 A max.	0,9 A max.
Maximum Weight	Male Contact	0.020 g		
	Female contact	0.020 g		
	Plug Insulator	0.021 g / cavity		
	Receptacle Insulator	0.006 g / cavity		
	Guide Posts (pair)	0.035 g		
	Latching Plug part	0.030 g		
	Latching Receptacle part	0.040 g		
	Solid Uninsulated Wire	1.60 g / m		
	Insulated Cable AWG26 (ESCC 390101302B)	2.30 g / m		
	Insulated Cable AWG28 (ESCC 390101301B)	1.80 g / m		
Residual Magnetism Level	20000 Gamma max. (NM)			



Dimensions are shown in mm (inch)  
Dimensions subject to change

# 3401-031 Microminiature MTB1

## How to order – Connector Style “Space ESA”

Description (example): 340103102B 12PFR116D1-4

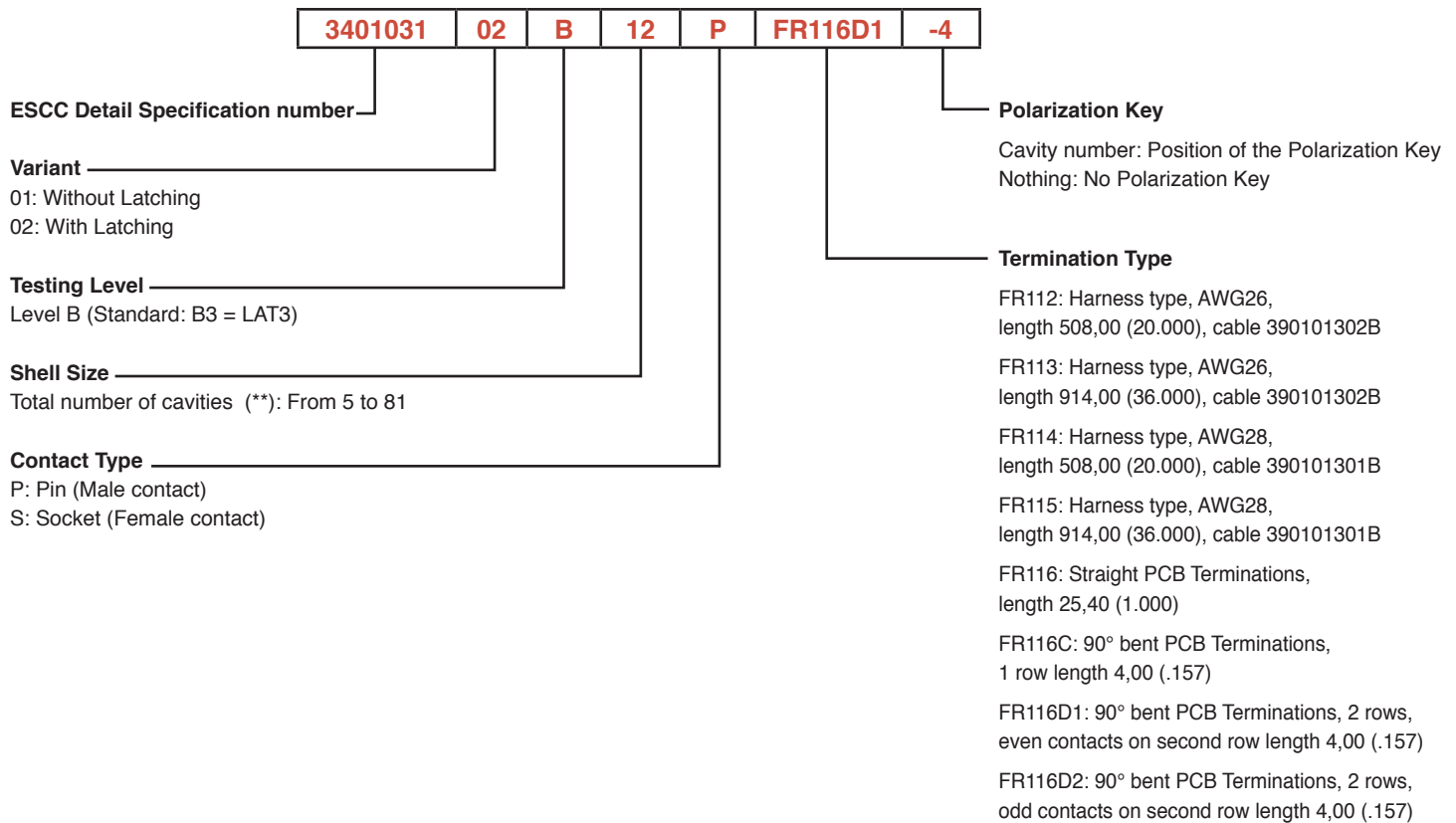

Other configurations available on request, consult factory.  
 CDRI (\*), with description MTB1-115288-xxxx

Note (\*\*): Connectors are described by the total number of cavities (N), including:

- Number of cavities for Epoxy: 0 (Not applicable)
- Number of cavities for Guide Posts: 2 (option) (Position 1 & N)
- Number of cavities for Polarization Key: 1 (option) (Position 1 to N)
- Number of cavities for Latching: 1 (option) (Position N/2 for even numbers, N/2 + 0.5 for odd numbers)
- Number of cavities for Contacts: N max. (Position 1 to N)

(\*): CDRI, see special section



Dimensions are shown in mm (inch)  
 Dimensions subject to change

# 3401-031 Microminiature MTB1

## How to order – Connector Style “Space FR022”

Description (example): MTB1-12PAL57D1-L-10-4-FR022

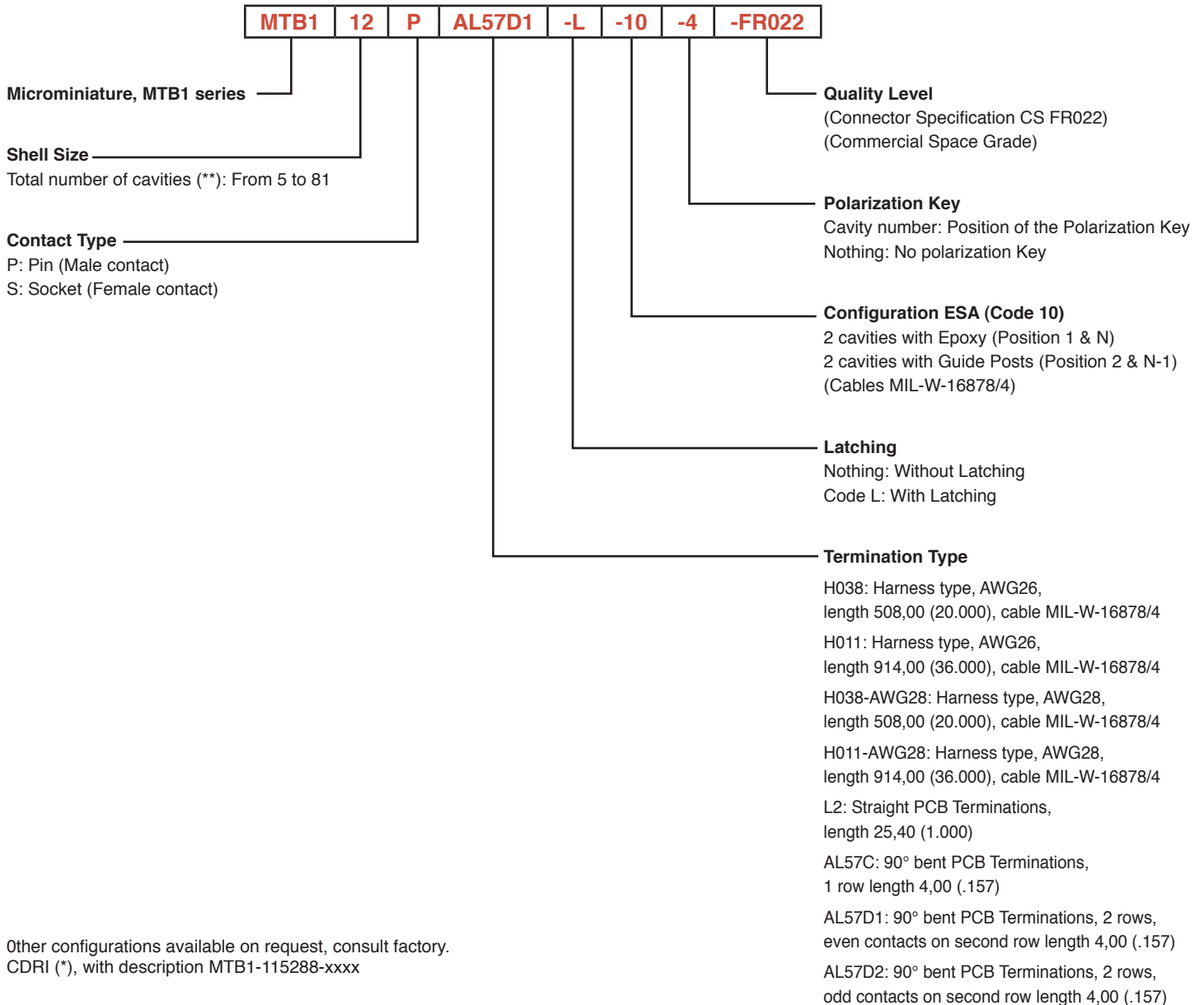

Note (\*\*): Connectors are described by the total number of cavities (N), including:

- Number of cavities for Epoxy: 2 (Position 1 & N)
- Number of cavities for Guide Posts: 2 (Position 2 & N-1)
- Number of cavities for Polarization Key: 1 (option) (Position 3 to N-2)
- Number of cavities for Latching: 1 (option) (Position N/2 for even numbers, N/2 + 0.5 for odd numbers)
- Number of cavities for Contacts: N-4 max. (Position 3 to N-2)

(\*): CDRI, see special section



Dimensions are shown in mm (inch)  
Dimensions subject to change

# 3401-031 Microminiature MTB1

## How to order – Connector Style “Standard FR022”

Description (example): MTB1-12PAL57-L-01-4-FR022

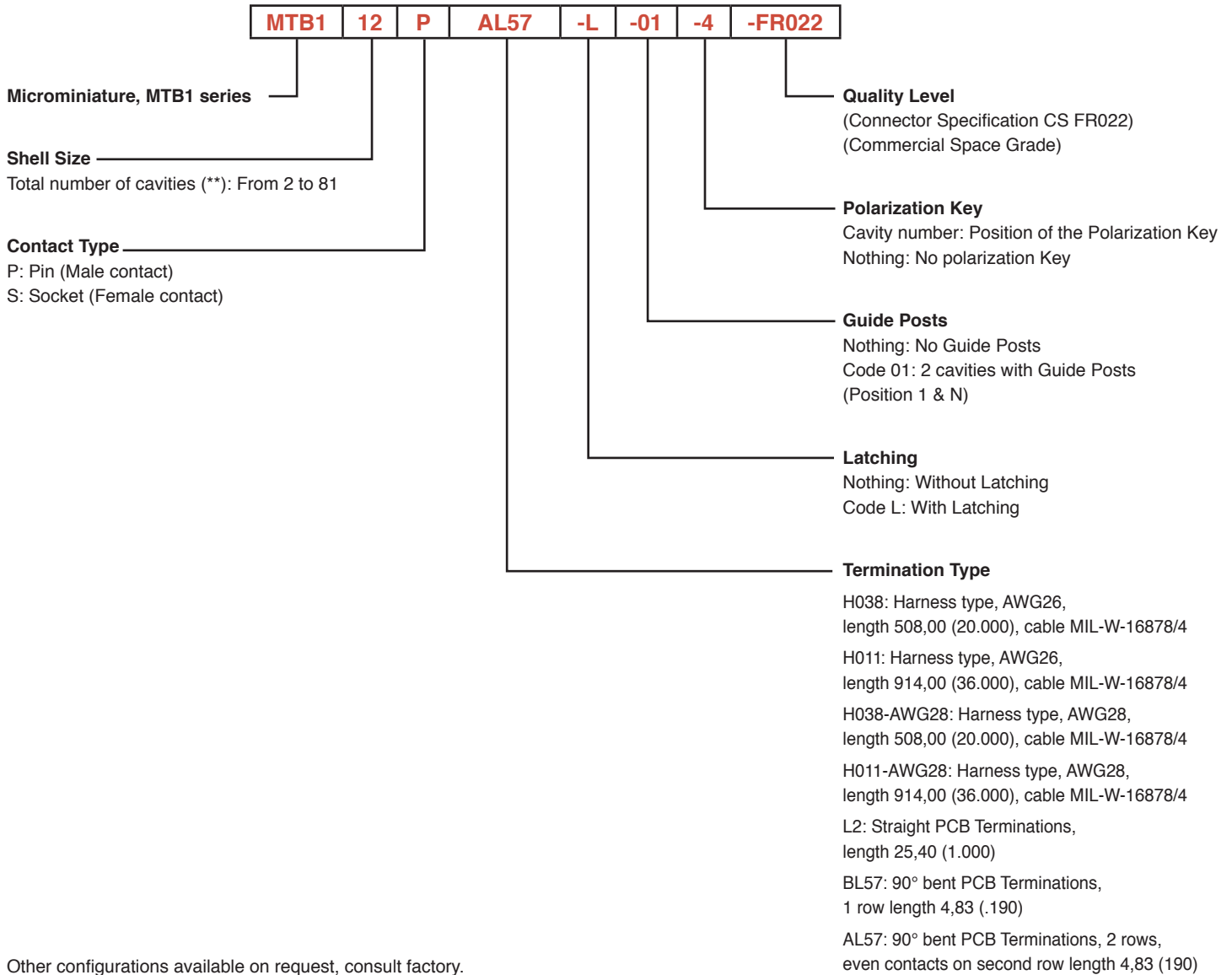

Note (\*\*): Connectors are described by the total number of cavities (N), including:

- Number of cavities for Epoxy: 0 (Not applicable)
- Number of cavities for Guide Posts: 2 (option) (Position 1 & N)
- Number of cavities for Polarization Key: 1 (option) (Position 1 to N)
- Number of cavities for Latching: 1 (option) (Position N/2 for even numbers, N/2 + 0.5 for odd numbers)
- Number of cavities for Contacts: N max. (Position 1 to N)

(\*): CDRI, see special section



Dimensions are shown in mm (inch)  
Dimensions subject to change

## Contact Design

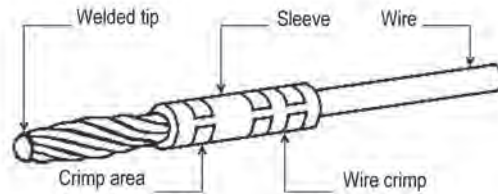

The high-performance and reliable contact characteristics are obtained by the Micropin™ contact system. The flexible “twist-pin” spring contact consists of 7 strands of 0,127 (.005) diameter beryllium copper wire helically wound around a core of 3 strands 0,09 (.0035) diameter soft copper wire. This wire bundle is crimped into a sleeve at one end. The other end is terminated with a hemispherically shaped weld. The wire bundle is compressed to create a bulge with a diameter slightly larger than the socket inside diameter. The pin elongates and twists when it enters the socket. Electrical contact is maintained along 7 spiral lines. The socket is a precision-made tube with a chamfered lead-in.



Twist-pin contacts will mate even under severe misalignment.

The flexible twist-pin is recessed into the insulator and the rigid socket is exposed, reversing the traditional positions of pin and socket. During mating, the socket is guided into the pin insulator by the lead-in chamfer. The pin is kept from flexing beyond the socket capture radius by the walls of the cavity. The hemispherical weld of controlled radius at the tip of the pin combines with the lead-in chamfers of the socket contact and the pin insulator to cam the pin into alignment. By controlling the welding process and the dimensions of the socket contact and the insulators, it is impossible for the recessed pin to escape the socket capture radius.

# 3401-031 Microminiature MTB1

## Terminations

Harness type insulated cables: AWG 26 to AWG 28, 7 strand, single-core cables.

AWG26, length 508,00 (20.000):			
- Cable ESCC 390101302B	Code FR112	(Space ESA)	
- Cable MIL-W-16878/4	Code H038	(Space and Standard FR022)	
AWG26, length 914,00 (36.000):			
- Cable ESCC 390101302B	Code FR113	(Space ESA)	
- Cable MIL-W-16878/4	Code H011	(Space and Standard FR022)	
AWG28, length 508,00 (20.000):			
- Cable ESCC 390101301B	Code FR114	(Space ESA)	
- Cable MIL-W-16878/4	Code H038-AWG28	(Space and Standard FR022)	
AWG28, length 914,00 (36.000):			
- Cable ESCC 390101301B	Code FR115	(Space ESA)	
- Cable MIL-W-16878/4	Code H011-AWG28	(Space and Standard FR022)	

Solid uninsulated wires (pigtailed): 0,45 (.018) diameter, AWG 25 Copper wire, Gold finish.

Straight terminations:			
- Length 25,40 (1.000)	Code FR116	(Space ESA)	
- Length 25,40 (1.000)	Code L2	(Space and Standard FR022)	

PCB terminations: 0,45 (.018) diameter, AWG 25 Copper wire, Gold finish.

90° bent PCB terminations, 1 row:			
- Length 4,00 (.157)	Code FR116C or AL57C	(Space ESA)	
- Length 4,83 (.190)	Code BL57	(Standard FR022)	
90° bent PCB terminations, 2 rows, even numbered contacts on second row:			
- Length 4,00 (.157)	Code FR116D1 or AL57D1	(Space ESA)	
- Length 4,83 (.190)	Code AL57	(Standard FR022)	
90° bent PCB terminations, 2 rows, odd numbered contacts on second row:			
- Length 4,00 (.157)	Code FR116D1 or AL57D2	(Space ESA)	
- Length 4,83 (.190)	Code not available: CDRI	(Standard FR022)	

Other termination types available on request: CDRI - Customer Design Request Information.

Termination Type		“Space ESA“ Style	“Space FR022“ Style	“Standard FR022“ Style
AWG26, L 508,00 (20.000)		FR112	H038	H038
AWG26, L 914,00 (36.000)		FR113	H011	H011
AWG28, L 508,00 (20.000)		FR114	H038-AWG28	H038-AWG28
AWG28, L 914,00 (36.000)		FR115	H011-AWG28	H011-AWG28
Straight PCB, L 25,40 (1.000)		FR116	L2	L2
90° bent PCB, 1 row	L 4,00 (.157)	FR116C	AL57C	N.A.
	L 4,83 (.190)	N.A.	N.A.	BL57
90° bent PCB, 2 rows, even numbered contacts on second row	L 4,00 (.157)	FR116D1	AL57D1	N.A.
	L 4,83 (.190)	N.A.	N.A.	AL57
90° bent PCB, 2 rows, odd numbered contacts on second row	L 4,00 (.157)	FR116D2	AL57D2	N.A.
	L 4,83 (.190)	N.A.	N.A.	N.A.: CDRI

N.A.: Not Applicable



Dimensions are shown in mm (inch)  
Dimensions subject to change



# 3401-031 Microminiature MTB1

## Dimensions

Shell Size

Described by the total number of insulator cavities.

<b>B</b>	2,03 ± 0,13 (.080 ± .005)
<b>C1</b>	2,54 ± 0,13 (.100 ± .005)
<b>C2</b>	7,19 ± 0,13 (.283 ± .005)
<b>D</b>	3,18 max. (.125 max.)
<b>E</b>	1,27 Typ. (.050 Typ.)

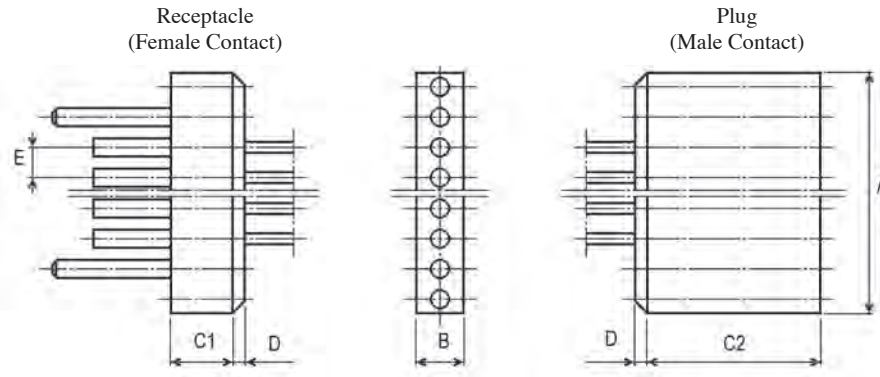

Rear potting (epoxy): Extension dimension D at the rear of the insulator.

Shell Size	A ± 0,38 (.015)	Shell Size	A ± 0,38 (.015)	Shell Size	A ± 0,38 (.015)	Shell Size	A ± 0,38 (.015)
2	3,05 (.120)	22	28,45 (1.120)	42	53,85 (2.120)	62	79,25 (3.120)
3	4,32 (.170)	23	29,72 (1.170)	43	55,12 (2.170)	63	80,52 (3.170)
4	5,59 (.220)	24	30,99 (1.220)	44	56,39 (2.220)	64	81,79 (3.220)
5	6,85 (.270)	25	32,26 (1.270)	45	57,66 (2.270)	65	83,06 (3.270)
6	8,13 (.320)	26	33,53 (1.320)	46	58,93 (2.320)	66	84,33 (3.320)
7	9,40 (.370)	27	34,80 (1.370)	47	60,20 (2.370)	67	85,60 (3.370)
8	10,67 (.420)	28	36,07 (1.420)	48	61,47 (2.420)	68	86,87 (3.420)
9	11,94 (.470)	29	37,34 (1.470)	49	62,74 (2.470)	69	88,14 (3.470)
10	13,20 (.520)	30	38,61 (1.520)	50	64,01 (2.520)	70	89,41 (3.520)
11	14,48 (.570)	31	39,88 (1.570)	51	65,28 (2.570)	71	90,68 (3.570)
12	15,75 (.620)	32	41,15 (1.620)	52	66,55 (2.620)	72	91,95 (3.620)
13	17,02 (.670)	33	42,42 (1.670)	53	67,82 (2.670)	73	93,22 (3.670)
14	18,29 (.720)	34	43,69 (1.720)	54	69,09 (2.720)	74	94,49 (3.720)
15	19,56 (.770)	35	44,96 (1.770)	55	70,36 (2.770)	75	95,76 (3.770)
16	20,83 (.820)	36	46,23 (1.820)	56	71,63 (2.820)	76	97,03 (3.820)
17	22,10 (.870)	37	47,50 (1.870)	57	72,90 (2.870)	77	98,30 (3.870)
18	23,37 (.920)	38	48,77 (1.920)	58	74,17 (2.920)	78	99,57 (3.920)
19	24,64 (.970)	39	50,04 (1.970)	59	75,44 (2.970)	79	100,84 (3.970)
20	25,91 (1.020)	40	51,31 (2.020)	60	76,71 (3.020)	80	102,11 (4.020)
21	27,18 (1.070)	41	52,58 (2.070)	61	77,98 (3.070)	81	103,38 (4.070)



Dimensions are shown in mm (inch)  
Dimensions subject to change

# 3401-031 Microminiature MTB1

## Contacts

Plug (Male Contact)

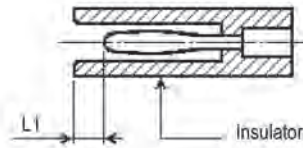

Receptacle (Female Contact)

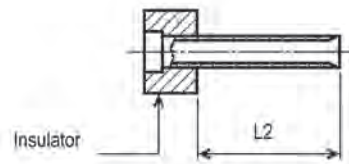

	Min.	Max.
<b>L1</b>	0,25 (.010)	0,91 (.036)
<b>L2</b>	3,07 (.121)	3,33 (.131)

Position of the Contacts:

- Cavities 3 to N-2 for the Space ESA (\*) and Space FR022
- Cavities 1 to N for the Standard FR022 (\*)

Note (\*): Optional accessories (Polarisation Key or Latching) placed in contact cavities, the remaining contact position numbers being unchanged.

## Guide Post / Polarization Key

- Purpose
- Guide Post: Pre-positioning of the contacts before mating.
  - Polarisation Key: Prevention against reversed position mating or mixing of similar variants.

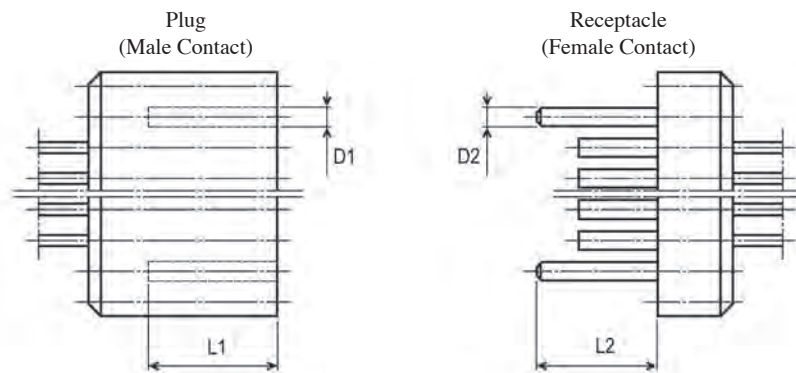

<b>D1</b>	0,90 ± 0,05 (.034 ± .002)
<b>D2</b>	0,81 ± 0,03 (.032 ± .001)
<b>L1</b>	5,40 min. (.213 min.)
<b>L2</b>	5,08 ± 0,25 (.200 ± .010)

# 3401-031 Microminiature MTB1

## Latching

Purpose: Optional locking mechanism of the mated connectors.

PLUG CONNECTOR: IS EQUIPPED WITH A RECEPTACLE LATCH

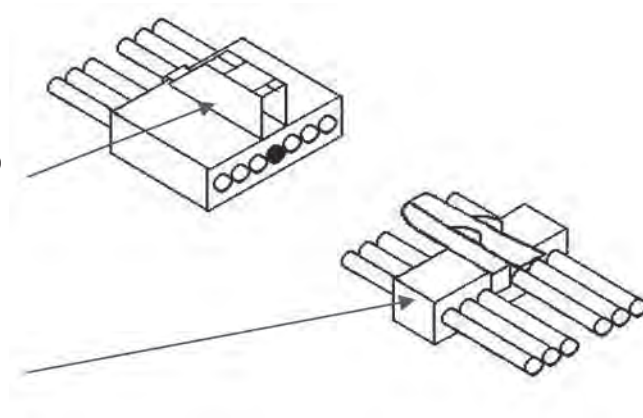

RECEPTACLE CONNECTOR IS EQUIPPED WITH THE PLUG LATCH

LOCKING CONDITIONS  
(RECEPTACLE LATCH)

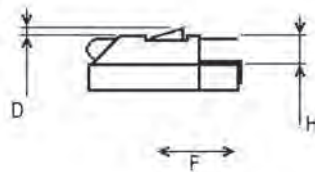

<b>H</b>	2,80 max. (.110 max.)
<b>D</b>	0,05 min. (.002 min.)

Latching force F: 10 N max.

UNLOCKING CONDITIONS  
(PLUG LATCH)

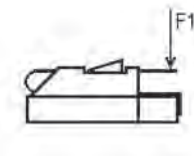

Unlocking force F1: 3 N min.

# 3401-031 Microminiature MTB1

## Straight PCB Terminations

(View from mating side)

### Space ESA and Space FR022 / Plug

(Male contacts)

Termination code: FR116

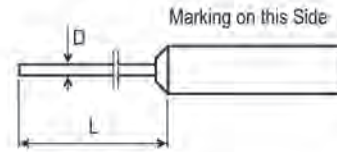
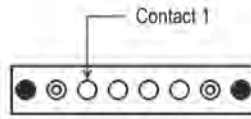

### Space ESA and Space FR022 / Receptacle

(Female contacts)

Termination code: FR116

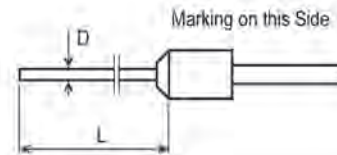
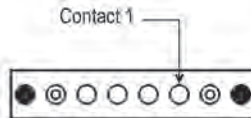

### Standard FR022 / Plug

(Male contacts)

Termination code: L2

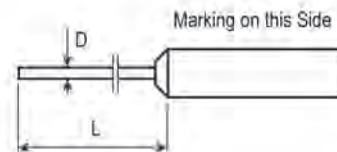
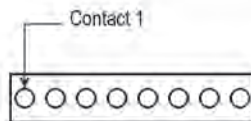

### Standard FR022 / Receptacle

(Female contacts)

Termination code: L2

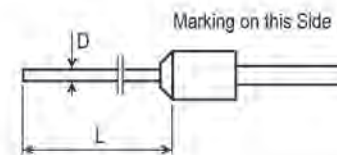
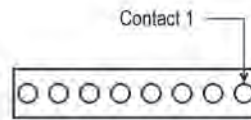

<b>D</b>	0,455 ± 0,055 (.018 ± .002)
----------	-----------------------------

<b>L</b>	25,40 min. (1.000 min.)
----------	-------------------------



Dimensions are shown in mm (inch)  
Dimensions subject to change

# 3401-031 Microminiature MTB1

## 90° bent PCB Terminations (1 row)

(View from mating side)

### Space ESA and Space FR022 / Plug

(Male contacts)

Termination code:

- ▣ Quality Level ESA: FR116C
- ▣ Quality Level FR022: AL57C

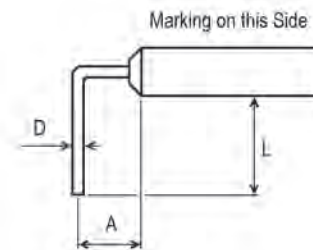
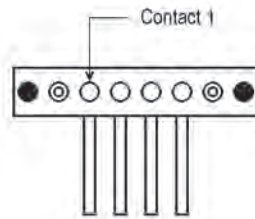

### Space ESA and Space FR022 / Receptacle

(Female contacts)

Termination code:

- ▣ Quality Level ESA: FR116C
- ▣ Quality Level FR022: AL57C

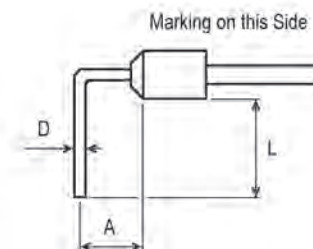
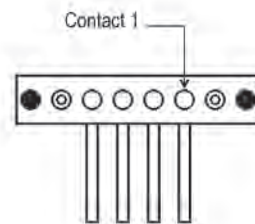

### Standard FR022 / Plug

(Male contacts)

Termination code: BL57

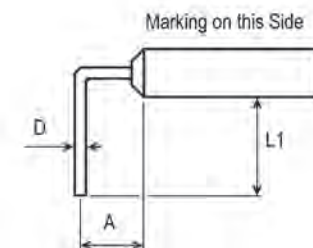
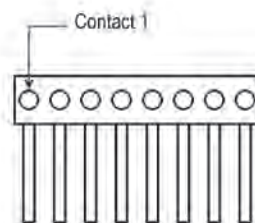

### Standard FR022 / Receptacle

(Female contacts)

Termination code: BL57

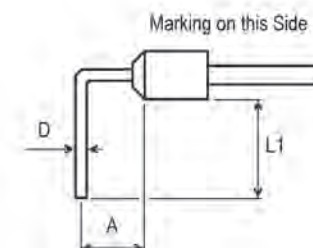
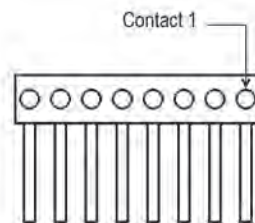

<b>A</b>	2,54 Typ (.100 Typ)
<b>D</b>	0,455 ± 0,055 (.018 ± .002)
<b>L</b>	4,00 min. (.157 min.)
<b>L1</b>	4,83 min. (.190 min.)



Dimensions are shown in mm (inch)  
Dimensions subject to change

# 3401-031 Microminiature MTB1

## 90° bent PCB Terminations (2 rows)

(View from mating side)

### Space ESA / Plug

(Male contacts)

Termination code:

- ▣ Quality Level ESA: FR116D1
- ▣ Quality Level FR022: AL57D1

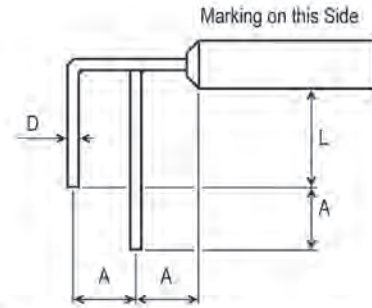
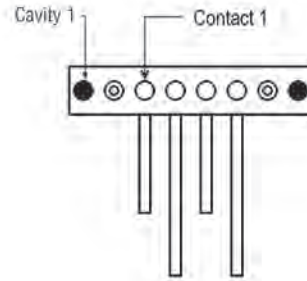

### Space ESA and Space FR022 / Receptacle

(Female contacts)

Termination code:

- ▣ Quality Level ESA: FR116D1
- ▣ Quality Level FR022: AL57D1

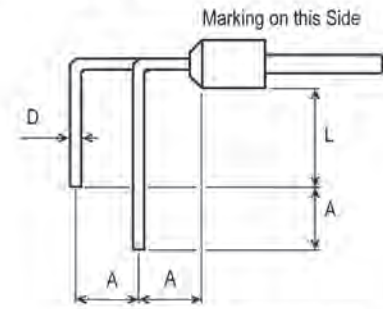
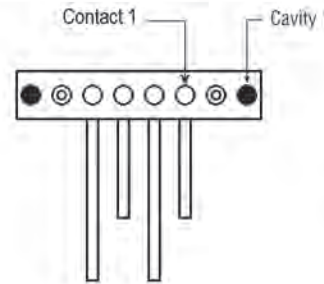

### Standard FR022 / Plug

(Male contacts)

Termination code: AL57

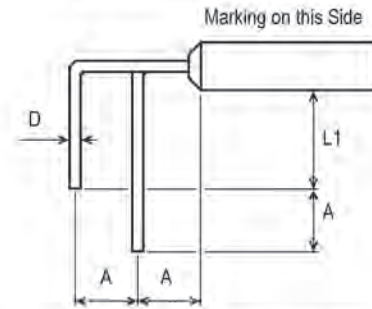
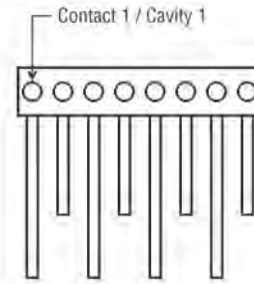

### Standard FR022 / Receptacle

(Female contacts)

Termination code: AL57

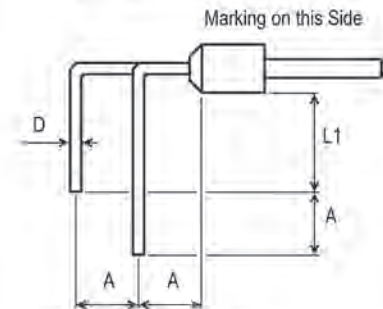
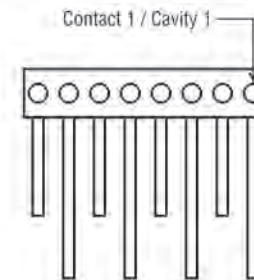

<b>A</b>	2,54 Typ (.100 Typ)
<b>D</b>	0,455 ± 0,055 (.018 ± .002)
<b>L</b>	4,00 min. (.157 min.)
<b>L1</b>	4,83 min. (.190 min.)



Dimensions are shown in mm (inch)  
Dimensions subject to change

# 3401-031 Microminiature MTB1

## 90° bent PCB Terminations (2 rows / contacts on second row on odd cavities)

(View from mating side)

### Space ESA and Space FR022 / Plug

(Male contacts)

Termination code:

- ▣ Quality Level ESA: FR116D2
- ▣ Quality Level FR022: AL57D2

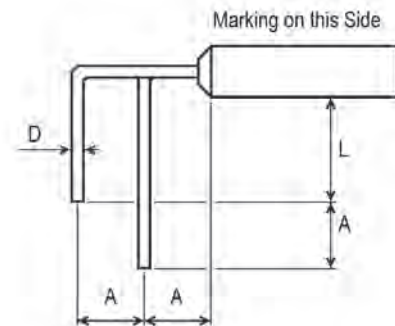
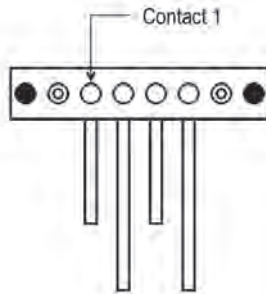

### Space ESA and Space FR022 / Receptacle

(Female contacts)

Termination code:

- ▣ Quality Level ESA: FR116D2
- ▣ Quality Level FR022: AL57D2

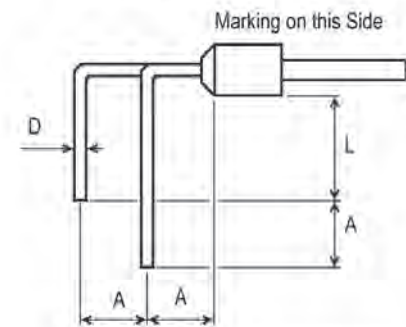
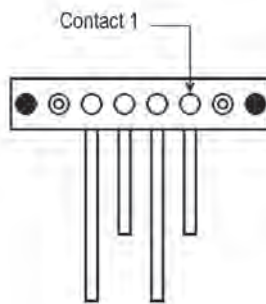

### Standard FR022 / Plug

(Male contacts)

Termination code: No code available  
Supply per CDRI (\*)

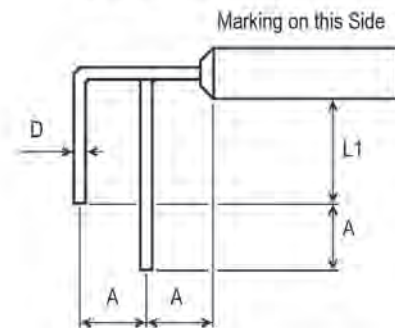
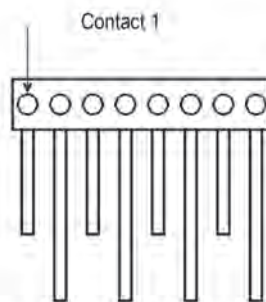

### Standard FR022 / Receptacle

(Female contacts)

Termination code: No code available  
Supply per CDRI (\*)

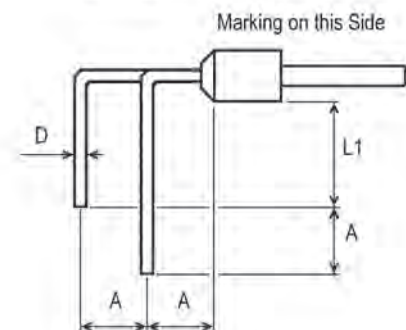
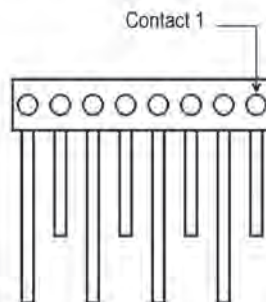

<b>A</b>	2,54 Typ (.100 Typ)
<b>D</b>	0,455 ± 0,055 (.018 ± .002)
<b>L</b>	4,00 min. (.157 min.)
<b>L1</b>	4,83 min. (.190 min.)

(\*): CDRI, see CDRI section



Dimensions are shown in mm (inch)  
Dimensions subject to change



# 3401-031 Microminiature MTB1

## Space ESA and Space FR022 Configuration

(Face view plug inserts. Use a mirror image for receptacle inserts)

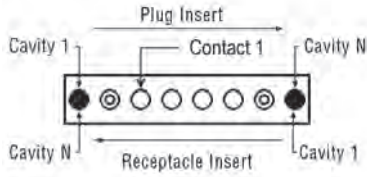

Options		Configurations	Number of Cavities		Cavity Identification			
			Total	Cts	Epoxy	G. Post	Polar.	Latch
		Cavity position (from left to right) = 1 to N						
Number of Cavities	Normal		N	N-4	1 & N	2 & N-1		
	Even							
	Odd		N	N-4	1 & N	2 & N-1		

Options		Configurations	Number of Cavities		Cavity Identification			
			Total	Cts	Epoxy	G. Post	Polar.	Latch
		Cavity position (from left to right) = 1 to N						
Number of Cavities	Polarization + Latching		N	N-6	1 & N	2 & N-1	3 to N-2	N/2
	Even							
	Odd		N	N-6	1 & N	2 & N-1	3 to N-2	N/2 + 0.5
Number of Cavities	Latching		N	N-5	1 & N	2 & N-1		N/2
	Even							
	Odd		N	N-5	1 & N	2 & N-1		N/2 + 0.5
Number of Cavities	Polarization		N	N-5	1 & N	2 & N-1	3 to N-2	
	Even							
	Odd		N	N-5	1 & N	2 & N-1	3 to N-2	

Example shown: Total number of cavities: 12 (even number) or 11 (odd number)  
Polarization Key placed on cavity number 4



Dimensions are shown in mm (inch)  
Dimensions subject to change



# 3401-031 Microminiature MTB1

## Standard FR022 without Guide Posts

(Face view plug inserts. Use a mirror image for receptacle inserts)

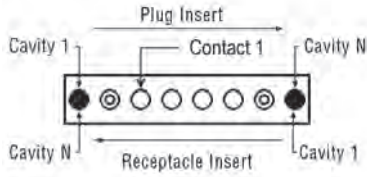

Options		Configurations	Number of Cavities		Cavity Identification			
			Total	Cts	Epoxy	G. Post	Polar.	Latch
		Cavity position (from left to right) = 1 to N						
Number of Cavities	Normal		N	N				
	Even							
	Odd		N	N				

Options		Configurations	Number of Cavities		Cavity Identification			
			Total	Cts	Epoxy	G. Post	Polar.	Latch
		Cavity position (from left to right) = 1 to N						
Number of Cavities	Polarization + Latching		N	N-2			1 to N	N/2
	Even							
	Odd		N	N-2			1 to N	N/2 + 0.5
Number of Cavities	Latching		N	N-1				N/2
	Even							
	Odd		N	N-1				N/2 + 0.5
Number of Cavities	Polarization		N	N-1			1 to N	
	Even							
	Odd		N	N-1			1 to N	

Example shown: Total number of cavities: 12 (even number) or 11 (odd number)  
Polarization Key placed on cavity number 4

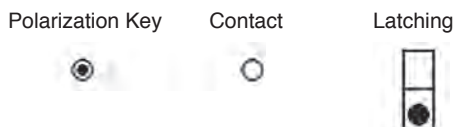

Dimensions are shown in mm (inch)  
Dimensions subject to change

# 3401-031 Microminiature MTB1

## Standard FR022 with Guide Posts

(Face view plug inserts. Use a mirror image for receptacle inserts)

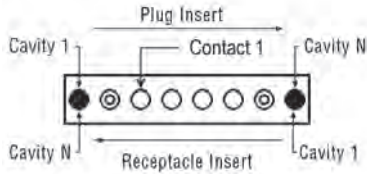

Options		Configurations	Number of Cavities		Cavity Identification			
			Total	Cts	Epoxy	G. Post	Polar.	Latch
		Cavity position (from left to right) = 1 to N						
Number of Cavities	Normal		N	N-2		1 & N		
	Even							
	Odd		N	N-2		1 & N		

Options		Configurations	Number of Cavities		Cavity Identification			
			Total	Cts	Epoxy	G. Post	Polar.	Latch
		Cavity position (from left to right) = 1 to N						
Number of Cavities	Polarization + Latching		N	N-4		1 & N	2 to N-1	N/2
	Even							
	Odd		N	N-4		1 & N	2 to N-1	N/2 + 0.5
Number of Cavities	Latching		N	N-3		1 & N		N/2
	Even							
	Odd		N	N-3		1 & N		N/2 + 0.5
Number of Cavities	Polarization		N	N-3		1 & N	2 to N-1	
	Even							
	Odd		N	N-3		1 & N	2 to N-1	

Example shown: Total number of cavities: 12 (even number) or 11 (odd number)  
Polarization Key placed on cavity number 4

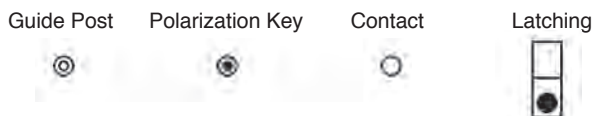

Dimensions are shown in mm (inch)  
Dimensions subject to change

## CDRI

### Description

The “Customer Design Request Information” document (CDRI) is an C&K Specification, describing a product supplied per specific customer specification.

For CDRI: Consult factory.

### Content

The CDRI document includes all the necessary data for:

- Customer use: characteristics of the product to be inserted into the Customer equipment
- C&K use: information for the manufacturing of the product

The main data are the following:

- Detailed description of the product
- Eventual applicable specifications or other documents
- Eventual drawings (Customer or C&K)
- Detailed amendments to the reference product (dimensions, piece parts, materials, cables)
- Detailed amendments to the manufacturing process (assembling, controls, marking, packaging, documentation)
- Quality level:
  - ESA: Supply in accordance with the requirements of the ESCC Generic Specification n° 3401
  - FR022: Supply in accordance with the requirements of the C&K Specification CS FR022
  - Other if applicable
- Allocated Descriptions and Part Numbers
- Allocated CDRI number

### Process

- Identification of the Customer request (specification, drawing, technical note)
- Analysis and feasibility study
- Proposal of the best solution, with eventual modifications
- Finalization of the Customer request
- Eventual prototype
- Commercial offer
- Finalization of the CDRI document

### Technical issues specific to the MTB1 Connectors

The amendments to the MTB1 Connectors described in this Catalogue can be made by the use of the following parameters:

- Other cable lengths
- Other PCB terminations
- Other cable references
- Cables AWG 30
- Coaxial cables, with conductor wired to a contact and shield wired to an adjacent contact or to an external cable
- Shielded cables, with conductor wired to a contact and shield wired to an adjacent contact or to an external cable
- Solder Cup terminations
- Protection of the specific wiring areas by thermo-shrinkable kynar tubes
- Transversal holes in the insulators for mechanical fixing onto PCB
- Extra-rear potting for Insulators strengthening



*Dimensions are shown in mm (inch)  
Dimensions subject to change*

## X-ON Electronics

Largest Supplier of Electrical and Electronic Components

*Click to view similar products for [Headers & Wire Housings](#) category:*

*Click to view products by [C&K](#) manufacturer:*

Other Similar products are found below :

[892-18-020-10-001101](#) [58102-G61-06LF](#) [582553-1](#) [0009485154](#) [009176003701906](#) [0050291907](#) [LY20-4P-DT1-P1E-BR](#) [02.125.8002.8](#)  
[609-3404](#) [61062-3](#) [61082-181009](#) [622-3653LF](#) [63453-116](#) [636-1030](#) [636-1427](#) [636-3427](#) [636-4007](#) [641938-9](#) [641991-4](#) [644827-2](#) [65817-](#)  
[010LF](#) [65817-015LF](#) [65863-015LF](#) [66207-023LF](#) [67095-007LF](#) [67601157](#) [68645-018](#) [68648-049](#) [70.362.1628.0](#) [70-4210](#) [70-4226B](#) [70-](#)  
[4853B](#) [707-5020](#) [707-5028](#) [71.350.2428.0](#) [71918-208LF](#) [71961-016LF](#) [733-134](#) [733-162](#) [754199-000](#) [760-3052](#) [787-8014-00](#) [79531-3000](#)  
[FCN-360C032-B](#) [FCN-367T-T012/H](#) [FCN-723D010/2](#) [80.063.4001.1](#) [800-90-001-10-001000](#) [800-90-010-10-002000](#) [801-43-002-10-013000](#)