

### Features and Benefits

- Compliant with ESA specification 3401/087
- Ultra-light weight
- Solid fully machined aluminium alloy material

### Typical Applications

- Space equipment
- Satellites harnesses

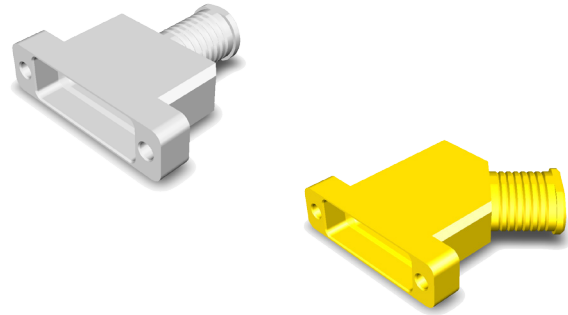

### Specification

- High performance Micro-D Lightweight Backshell ESA qualified, for space applications.
- Compliant with ESCC specifications 3401/087 Lightweight Backshells for 3401/029 and 3401/077 Micro-D Connectors.
- Compatible with ESCC 3401/032 accessories.
- Suitable for use in Space, and high performance military/aerospace applications: Board to Cable or Cable to Cable applications.
- Sizes available: 9, 15, 21, 25, 31, 37 and 51 ways.
- Outlets:
  - Top circular
  - Top elliptical
  - 45° circular
  - 45° elliptical

### Electrical & Mechanical Characteristics

CHARACTERISTIC	SPECIFICATION
Operating Temperature range	-55 / + 125°C
Storage temperature range	-55 / + 125°C

### Quality

- ESA / ESCC: code 3401 (Flying model).
- Qualification reviewed every 2 years.

### Option

- Male screwlock with clip (be ordered separately).

### Packaging

- Individual packaging.
- Traceability associated as per ESA/ESCC specifications.

COMPONENT	MATERIAL	FINISH
Backshell ESCC Variants 01 to 07, 15 to 21, 29 to 35, 43 to 49	Aluminium Alloy 6061-T6	25.4µm min. electroless Nickel
Backshell ESCC Variants 08 to 14, 22 to 28, 36 to 42, 50 to 56	Aluminium Alloy 6061-T6	0.7µm min. Gold over 25.4µm min. electroless Nickel
Male Screwlock	Passivated Stainless Steel	None
Clip	Passivated Stainless Steel	None

# MDM LIGHTWEIGHT BACKSHELL TOP CIRCULAR ENTRY

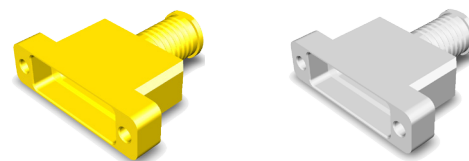

## DIMENSIONS AND WEIGHT

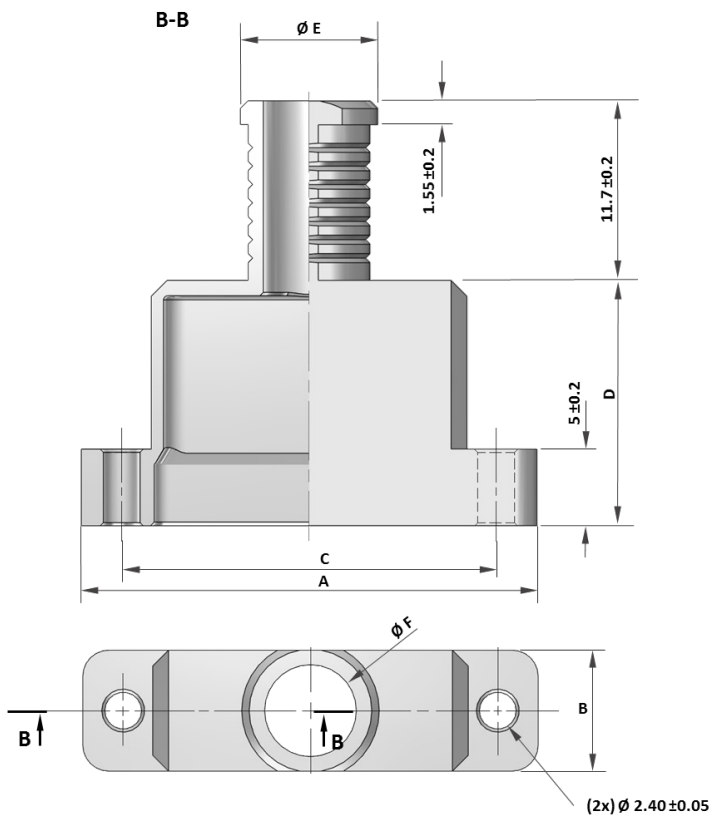

SIZE	A ±0.2	B ±0.2	C ±0.1	D ±0.2	ØE ±0.2	ØF ±0.2	WEIGHT (GRAMS)
9	19.65	7.90	14.35	10.00	9.00	6.00	3
15	23.45	7.90	18.16	12.00	9.00	6.00	3
21	27.25	7.90	21.97	14.00	9.00	6.00	4
25	29.80	7.90	24.51	16.00	9.00	6.00	4
31	33.60	7.90	28.32	17.00	9.00	6.00	5
37	37.40	7.90	32.13	18.00	9.00	6.00	5
51	36.15	8.90	30.86	19.00	10.00	7.00	6

## DESCRIPTION AND PART NUMBERS

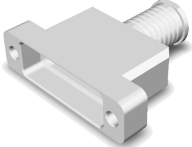
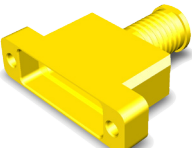
SHELL FINISH	CONTACT SIZE	ESA/ESCC DESCRIPTION	C&K PN
 Electroless Nickel	9	340108701B	C115366-1032D
	15	340108702B	C115366-1033D
	21	340108703B	C115366-1034D
	25	340108704B	C115366-1035D
	31	340108705B	C115366-1036D
	37	340108706B	C115366-1037D
	51	340108707B	C115366-1038D
 Gold	9	340108708B	C115366-1032C
	15	340108709B	C115366-1033C
	21	340108710B	C115366-1034C
	25	340108711B	C115366-1035C
	31	340108712B	C115366-1036C
	37	340108713B	C115366-1037C
	51	340108714B	C115366-1038C



Dimensions shown in: mm  
Specifications and dimensions subject to change

# MDM LIGHTWEIGHT BACKSHELL TOP ELLIPTICAL ENTRY

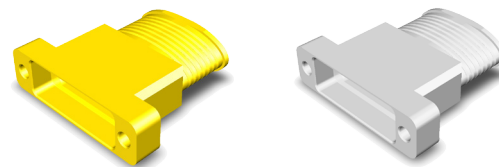

## DIMENSIONS AND WEIGHT

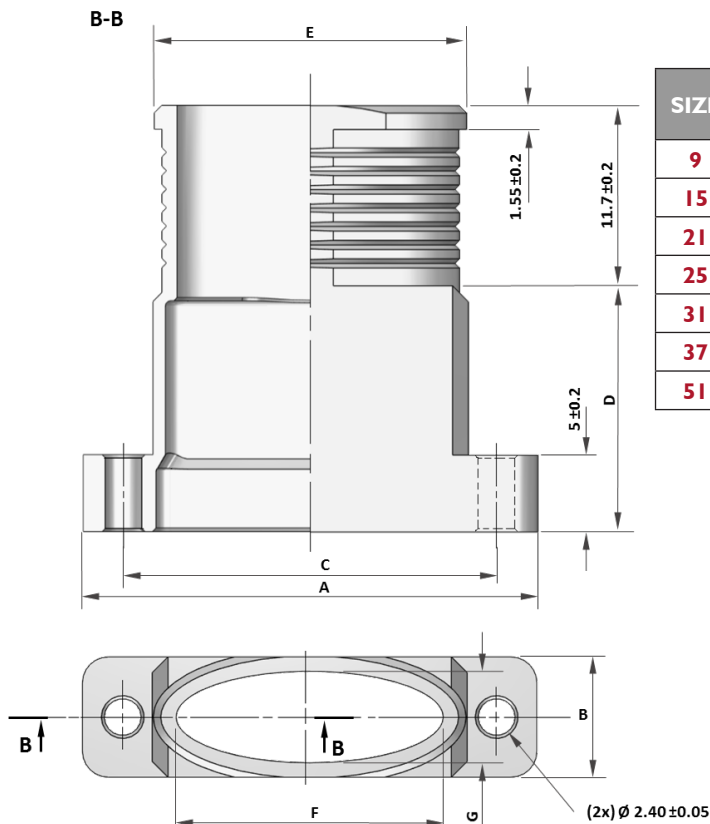

SIZE	A ±0.2	B ±0.2	C ±0.1	D ±0.2	E ±0.2	F ±0.2	G ±0.2	WEIGHT (GRAMS)
9	19.65	7.90	14.35	10.00	10.90	7.90	6.00	3
15	23.45	7.90	18.16	12.00	13.70	10.70	6.00	4
21	27.25	7.90	21.97	14.00	18.00	15.00	6.00	4
25	29.80	7.90	24.51	16.00	20.50	17.50	6.00	4
31	33.60	7.90	28.32	17.00	23.80	20.80	6.00	5
37	37.40	7.90	32.13	18.00	27.60	24.60	6.00	6
51	36.15	8.90	30.86	19.00	26.40	23.40	7.00	6

## DESCRIPTION AND PART NUMBERS

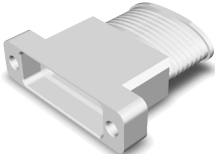
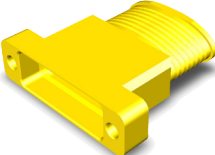
SHELL FINISH	CONTACT SIZE	ESA/ESCC DESCRIPTION	C&K PN
 Electroless Nickel	9	340108715B	CI15366-1039D
	15	340108716B	CI15366-1040D
	21	340108717B	CI15366-1041D
	25	340108718B	CI15366-1042D
	31	340108719B	CI15366-1043D
	37	340108720B	CI15366-1044D
	51	340108721B	CI15366-1045D
 Gold	9	340108722B	CI15366-1039C
	15	340108723B	CI15366-1040C
	21	340108724B	CI15366-1041C
	25	340108725B	CI15366-1042C
	31	340108726B	CI15366-1043C
	37	340108727B	CI15366-1044C
	51	340108728B	CI15366-1045C



Dimensions shown in: mm  
Specifications and dimensions subject to change

**MDM LIGHTWEIGHT BACKSHELL**  
**45° CIRCULAR ENTRY**  
*(Our design accepts right or left mounting)*

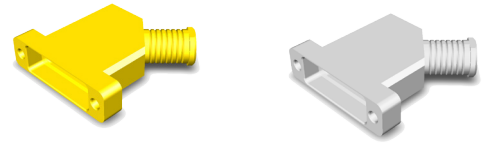

**DIMENSIONS AND WEIGHT**

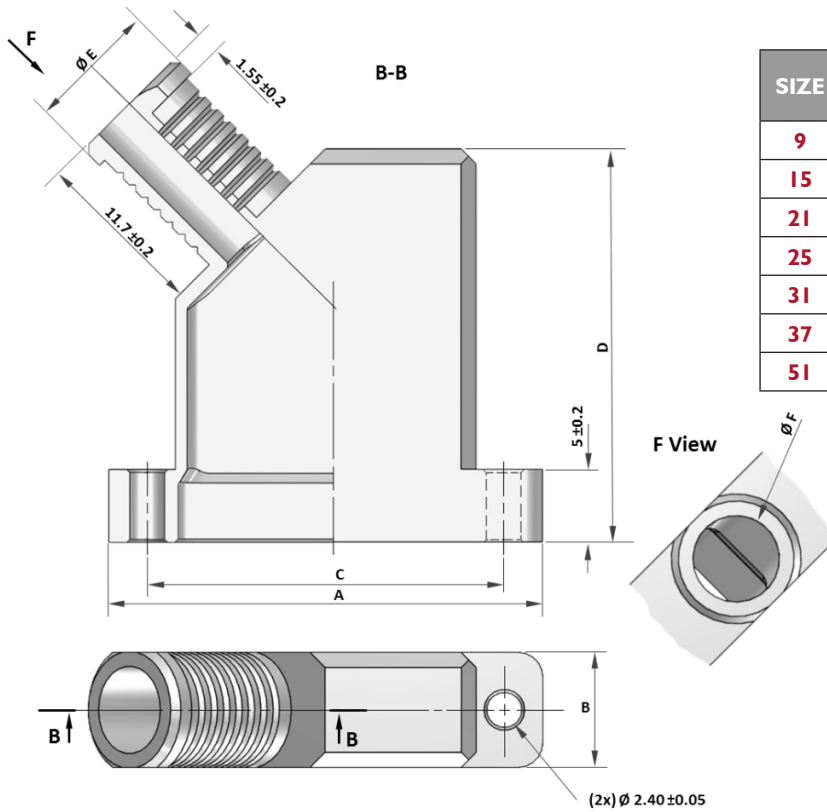

SIZE	A $\pm 0.2$	B $\pm 0.2$	C $\pm 0.1$	D $\pm 0.2$	$\phi E$ $\pm 0.2$	$\phi F$ $\pm 0.2$	WEIGHT (GRAMS)
9	19.65	7.90	14.35	21.00	8.30	5.30	3
15	23.45	7.90	18.16	23.00	9.00	6.00	4
21	27.25	7.90	21.97	24.00	9.00	6.00	4
25	29.80	7.90	24.51	27.00	9.00	6.00	5
31	33.60	7.90	28.32	28.00	9.00	6.00	5
37	37.40	7.90	32.13	29.00	9.00	6.00	6
51	36.15	8.90	30.86	30.00	10.00	7.00	6

**DESCRIPTION AND PART NUMBERS**

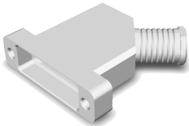
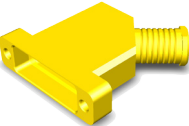
SHELL FINISH	CONTACT SIZE	ESA/ESCC DESCRIPTION	C&K PN
 Electroless Nickel	9	340108729B	CI15366-1046D
	15	340108730B	CI15366-1047D
	21	340108731B	CI15366-1048D
	25	340108732B	CI15366-1049D
	31	340108733B	CI15366-1050D
	37	340108734B	CI15366-1051D
	51	340108735B	CI15366-1052D
 Gold	9	340108736B	CI15366-1046C
	15	340108737B	CI15366-1047C
	21	340108738B	CI15366-1048C
	25	340108739B	CI15366-1049C
	31	340108740B	CI15366-1050C
	37	340108741B	CI15366-1051C
	51	340108742B	CI15366-1052C



Dimensions shown in: mm  
 Specifications and dimensions subject to change

**MDM LIGHTWEIGHT BACKSHELL**  
**45° ELLIPTICAL ENTRY**  
*(Our design accepts right or left mounting)*

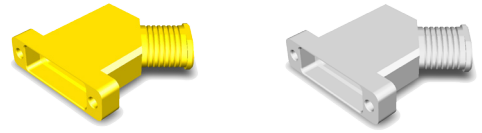

**DIMENSIONS AND WEIGHT**

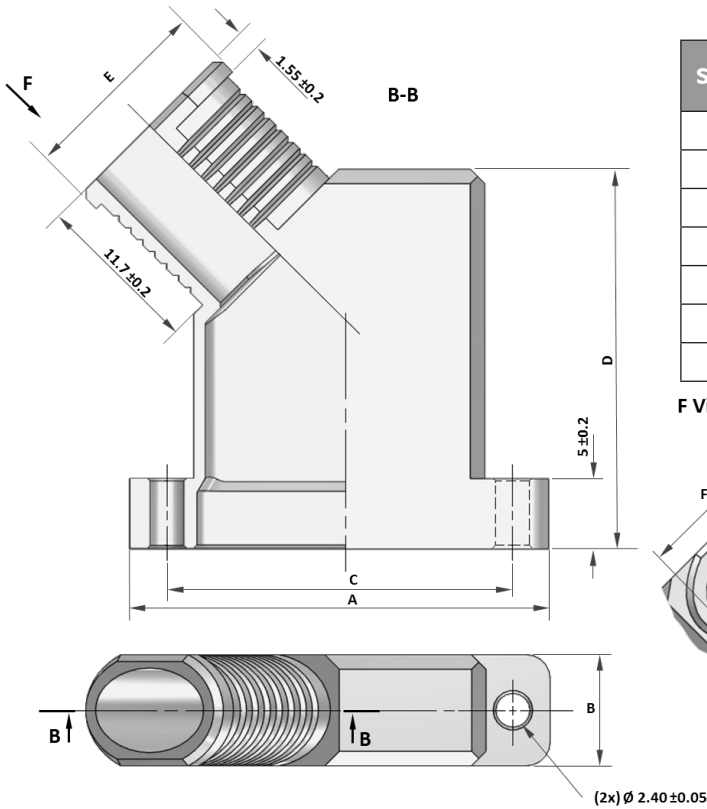

SIZE	A ±0.2	B ±0.2	C ±0.1	D ±0.2	E ±0.2	F ±0.2	G ±0.2	WEIGHT (GRAMS)
9	19.65	7.90	14.35	21.00	8.00	5.00	6.00	3
15	23.45	7.90	18.16	23.00	10.50	7.50	6.00	4
21	27.25	7.90	21.97	24.00	12.50	9.50	6.00	5
25	29.80	7.90	24.51	27.00	13.80	10.80	6.00	5
31	33.60	7.90	28.32	28.00	15.50	12.50	6.00	6
37	37.40	7.90	32.13	29.00	18.00	15.00	6.00	6
51	36.15	8.90	30.86	30.00	20.00	17.00	7.00	7

**DESCRIPTION AND PART NUMBERS**

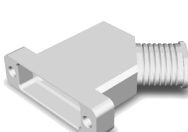
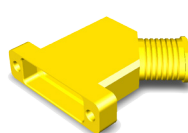
SHELL FINISH	CONTACT SIZE	ESA/ESCC DESCRIPTION	C&K PN
 Electroless Nickel	9	340108743B	CI15366-1053D
	15	340108744B	CI15366-1054D
	21	340108745B	CI15366-1055D
	25	340108746B	CI15366-1056D
	31	340108747B	CI15366-1057D
	37	340108748B	CI15366-1058D
	51	340108749B	CI15366-1059D
 Gold	9	340108750B	CI15366-1053C
	15	340108751B	CI15366-1054C
	21	340108752B	CI15366-1055C
	25	340108753B	CI15366-1056C
	31	340108754B	CI15366-1057C
	37	340108755B	CI15366-1058C
	51	340108756B	CI15366-1059C



Dimensions shown in: mm  
 Specifications and dimensions subject to change

## ACCESSORIES

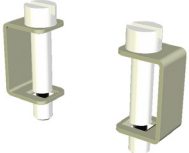
MALE SCREWLOCK	ESA/ESCC DESCRIPTION	C&K P/N
	340103218B	C115366-1060C

---

**AMERICAS**

Tel: +1.617.969.3700

**ASIA**

Tel: +852.3713.5288

**EUROPE**

Tel: +33.1.60.24.51.51



## X-ON Electronics

Largest Supplier of Electrical and Electronic Components

*Click to view similar products for [D-Sub Tools & Hardware](#) category:*

*Click to view products by [C&K](#) manufacturer:*

Other Similar products are found below :

[000-01-09-132](#) [000-01-21-132](#) [000-01-31-162](#) [572019-00105-70](#) [000-01-37-162](#) [621-250-113-115](#) [D110550-2](#) [D20418-137](#) [780-518-50SG6-WS](#) [86552009](#) [86553115TLF](#) [86553117TLF](#) [1230032-1](#) [1-5021101-2](#) [1589283-4](#) [160-000-005R031](#) [16-000230](#) [160-025-004R031](#) [160-000-137R000](#) [160-020-209R000](#) [164C03939A](#) [177-505-A-2-2](#) [1-966830-8](#) [21018-6](#) [21028-2](#) [2-1393560-9](#) [JS-1000](#) [L17D204182M3E](#) [L17D53018](#) [300X10779X](#) [160X10189X](#) [160X10419X](#) [160X10959X](#) [162-000-050R000](#) [21018-5](#) [212561-3](#) [248C21550X](#) [CF15P](#) [QLOCKPOST-2](#) [D110277](#) [500-008NF1K-01](#) [500-008NF3R3KS-01](#) [500-017M09FN](#) [500-017M15MHN](#) [500-024M1](#) [500-068M3](#) [5-1393561-5](#) [C115373-0001](#) [C115373-0002](#) [3342-4-KIT](#)