



Features/Benefits

- Subminiature size—capable of switching 1 AMP
- Vertical & right angle terminations
- PC & panel mount models
- Snap-in front panel mounting available
- Epoxy terminal seal-compatible with bottom wash cleaning
- RoHS compliant models available



Models Available

Typical Applications

- Telecommunications and networking equipment
- Computers and peripherals
- Instrumentation and controls



Specifications

CONTACT RATING: B contact material: 0.4 VA max. @ 20 V AC or DC max. Q contact material: 1 AMP @ 120 V AC or 28 V DC. See page A-19 for additional ratings.

ELECTRICAL LIFE: TP11, TP21 MODELS: 60,000 make-and-break cycles at full load. TP12 MODELS: 30,000 cycles.

CONTACT RESISTANCE: Below 20 mΩ 15 typ. initial @ 2-4 V DC, 100 mA, for both silver and gold plated contacts.

INSULATION RESISTANCE: 10⁹Ω 15min.

DIELECTRIC STRENGTH: 1000 Vrms min. @ sea level.

OPERATING TEMPERATURE: -30°C to 85°C.

SOLDERABILITY: Per MIL-STD-202F method 208D, or EIA RS-186E method 9 (1 hour steam aging).

NOTE: Any models supplied with Q, B, P, R or G contact material are RoHS compliant.

NOTE: Specifications and materials listed above are for switches with standard options. For information on specific and custom switches, consult Customer Service Center.

Materials

CASE: Glass filled nylon 4/6 or 6/6, flame retardant, heat stabilized or diallyl phthalate (DAP), (UL 94V-0).

PLUNGER: Thermoplastic polyester (UL 94V-0).

CAP & FRAME: Nylon, black standard.

BUSHING: Brass, nickel plated.

HOUSING: Stainless steel.

SWITCH SUPPORT: Brass, matte-tin plated.

END CONTACTS: B contact material: Copper alloy, with gold plate over nickel plate. Q contact material: Coin silver, silver plated. See page A-19 for additional contact materials.

CENTER CONTACT & ALL TERMINALS: B contact material: Copper alloy, with gold plate over nickel plate. Q contact material: Copper alloy, silver plated. See page A-19 for additional contact materials.

TERMINAL SEAL: Epoxy. Refer to soldering and cleaning in Technical Data Chapter

HARDWARE: Nut & Locking Ring: Brass nickel plated.
Lockwasher: Steel, nickel plated.

Build-A-Switch

To order, simply select desired option from each category and place in the appropriate box. Available options are shown and described on pages A-16 thru A-20. For additional options not shown in catalog, consult Customer Service Center. All models have epoxy terminal seal and are compatible with all “bottom-wash” PCB cleaning methods.

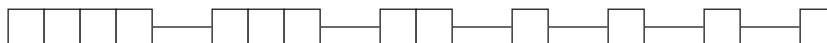

Switch Function

- TP11** SPST Off-Mom.
TP12 SPDT On-Mom.
TP21 DPST Off-Mom.

Actuator or Bushing

- SH** .155" high plunger, threaded,
.220" high bushing, flat
- SH8** .155" high plunger, unthreaded,
.220" high bushing, round
- SH9** .155" high plunger, unthreaded,
.220" high bushing, flat
- J81** Snap-in with frame
- LT** .215" high plunger, threaded,
.310" high bushing, flat
- LT9** .215" high plunger, unthreaded,
.310" high bushing, flat
- MS9** .130" high plunger,
.020" high bushing, round

Terminations

- A** Right angle, PC thru-hole
C PC Thru-hole
Z Solder lug
AV Vertical right angle, PC thru-hole
V3 Vertical mount, v-bracket
W Wire wrap

Contact Material

- B** Gold
P Gold, matte-tin
Q Silver
G Gold over silver
R Gold over silver, matte-tin

Seal

- E** Epoxy

Cap Color

- 2** Black
NONE Models with no cap
1 White

Frame Color

- 2** Black
NONE Models with no frame



TP Series Tiny Pushbutton Switches

SWITCH FUNCTION



Pushbutton
A

NO. POLES	MODEL NO.	SWITCH FUNCTION		CONNECTED TERMINALS		SCHEMATIC
		POS. 1	POS. 2	POS. 1	POS. 2	
		C&K marking on opposite side		C&K marking on opposite side		
SP	TP11	OFF	MOM.	OPEN	1-3	SPST
	TP12	ON	MOM.		2-3	SPDT
SPDT <p>Part number shown: TP12SHZQE</p> <p>Terminal Nos. For Reference Only</p>						
DP	TP21	OFF	MOM.	OPEN	1-3,4-6	DPST
DPST <p>Part number shown: TP21SHZQE</p> <p>Terminal Nos. For Reference Only</p>						

MOM. = Momentary

All models with all options when ordered with G, Q or R contact material.

ACTUATOR—SNAP-IN FRONT MOUNT

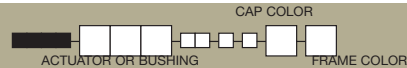

J81 SNAP-IN WITH FRAME

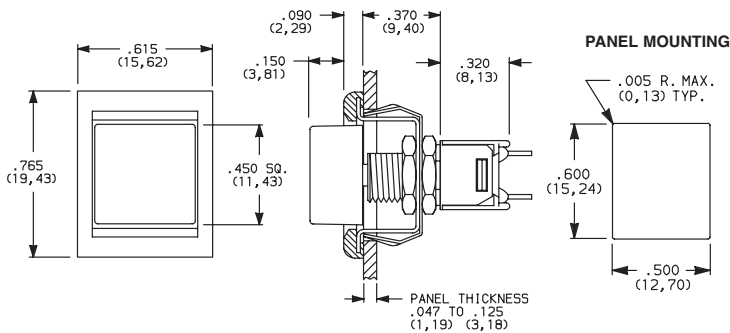

OPTION CODE	CAP COLOR
2	BLACK
1	WHITE

OPTION CODE	FRAME COLOR
2	BLACK
NONE	No Frame Color (J80 option)

Cap and Frame Finish: matte. Other colors available, consult Customer Service Center.
NOTE: Available with Z, C, or W terminations.

NOTE: Caps & frames available separately, see page A-20.

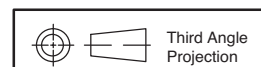

Dimensions are shown: Inches (mm)
Specifications and dimensions subject to change



5 Aug 20

TP Series Tiny Pushbutton Switches



A
Pushbutton

BUSHING

SH .155" HIGH PLUNGER,
.220" HIGH BUSHING,
THREADED, FLAT

SH8 .155" HIGH PLUNGER,
.220" HIGH BUSHING,
UNTHREADED

SH9 .155" HIGH PLUNGER,
.220" HIGH BUSHING,
UNTHREADED, FLAT

LT .21517" HIGH PLUNGER, **MS9** .130" HIGH
.310" HIGH BUSHING,
THREADED
PLUNGER

LT9 .215"17 HIGH PLUNGER,
.310" HIGH BUSHING,
UNTHREADED

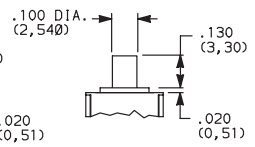
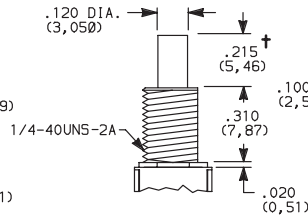
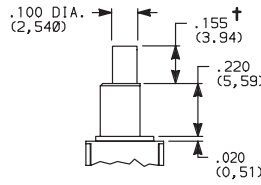
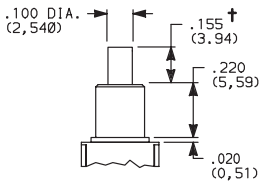
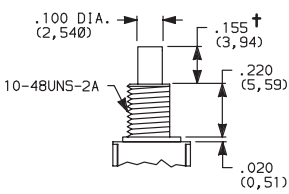
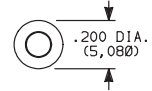
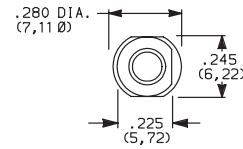
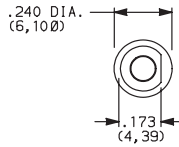
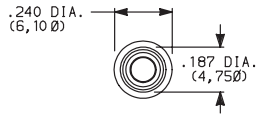
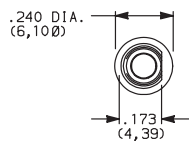

Standard with Z, C, W terminations.

Standard with A, AV, V3 terminations.

Not available with
Z terminations.

† Subtract .016 (0,41) for models with A, AV or V3 terminations.

NOTE: Caps available for plunger options, see page A-20.

PANEL MOUNTING

10-48 BUSHING

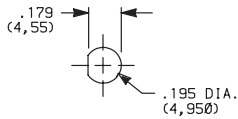

Without locking ring

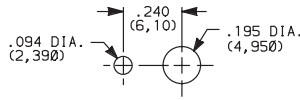

With standard locking ring

1/4 IN. BUSHING

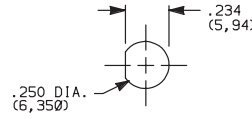

Without locking ring

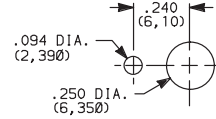

With standard locking ring

NOTE: One mounting nut, locking ring and lockwasher supplied standard with 10-48 threaded bushings (two nuts with 1/4-40 bushings).
Optional mounting nut and locking ring styles and finishes available separately, see section "Technical Data and Additional Hardware".

TERMINATIONS

C PC THRU-HOLE

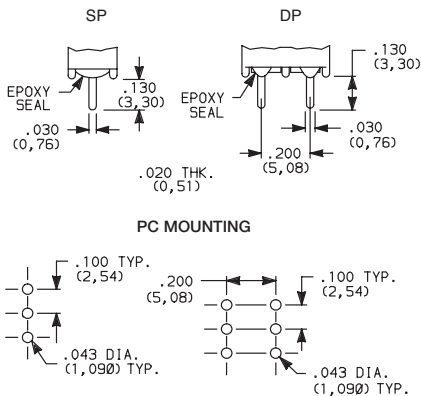

Omit center holes
for TP11 models

Z SOLDER LUG

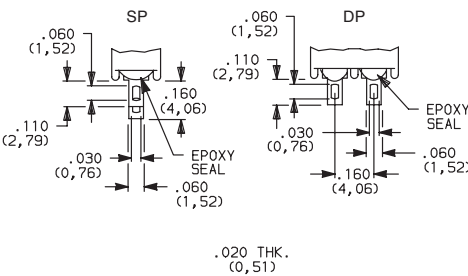

Not available with MS9 bushing or P
or R contact material.

W WIRE WRAP

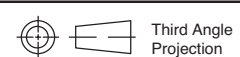
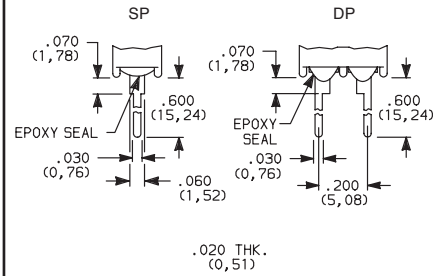

Dimensions are shown: Inches (mm)
Specifications and dimensions subject to change



TP Series Tiny Pushbutton Switches

TERMINATIONS



Pushbutton

A

A RIGHT ANGLE, PC THRU-HOLE



TP12SH9ABE
SPDT

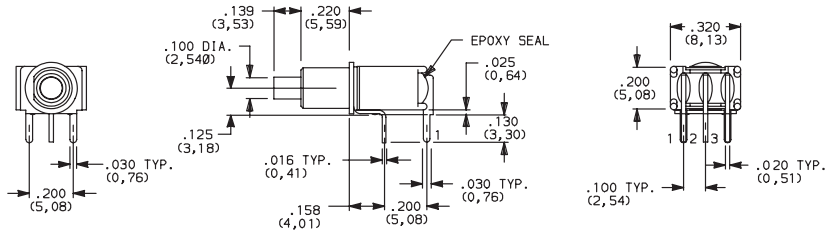

PC MOUNTING

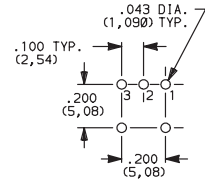

TP11 Models:
omit terminal 2.

TP11 Models:
omit hole 2.

A RIGHT ANGLE, PC THRU-HOLE

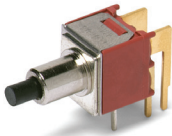

TP21SH9ABE
DPST

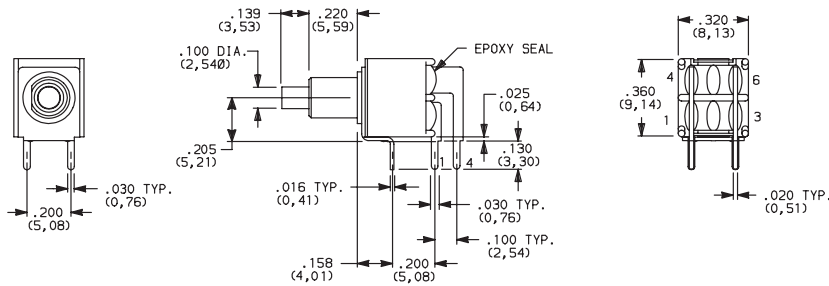

PC MOUNTING

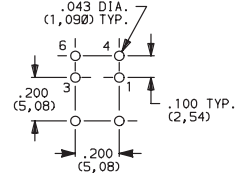

AV VERTICAL RIGHT ANGLE, PC THRU-HOLE

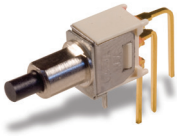

TP12SH9AVBE
SPDT

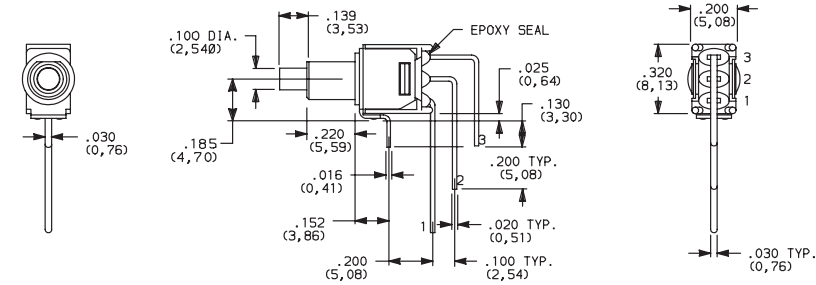

PC MOUNTING

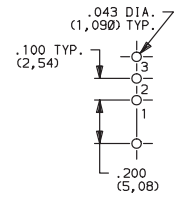

TP11 Models:
omit terminal 2.

TP11 Models:
omit hole 2.

NOTE: Terminal bend radii and lead-in manufacturing option.

AV VERTICAL RIGHT ANGLE, PC THRU-HOLE

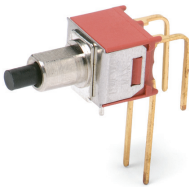

TP21SH9AVBE
DPST

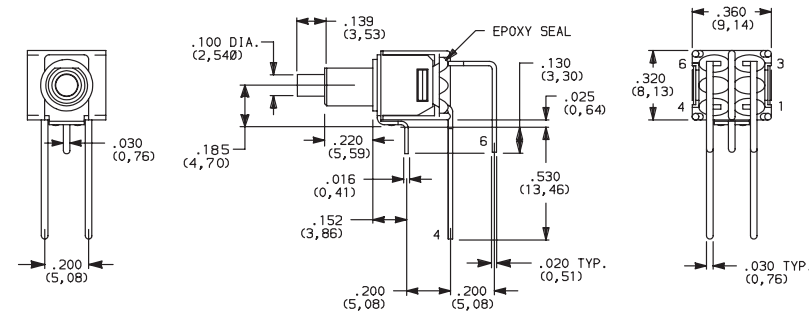

PC MOUNTING

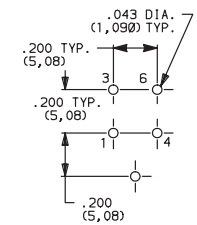

NOTE: Terminal bend radii and lead-in manufacturing option.



5 Aug 20

Dimensions are shown: Inches (mm)
Specifications and dimensions subject to change

www.ckswitches.com



TERMINATIONS

V3 VERTICAL MOUNT, V-BRACKET

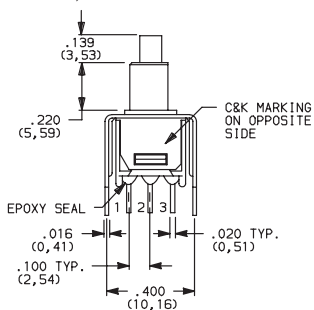

TP11 Models:
omit terminal 2.

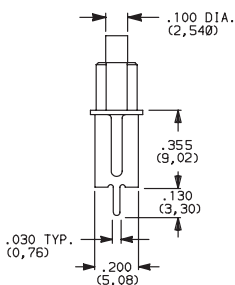

PC MOUNTING

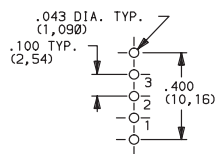

TP11 Models:
omit hole 2.



TP12SH9V3BE
SPDT

V3 VERTICAL MOUNT, V-BRACKET

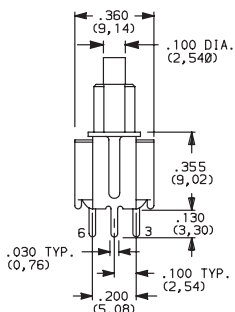
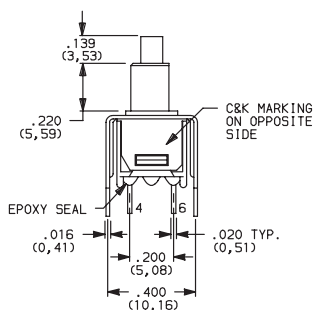

PC MOUNTING

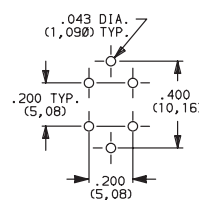

TP21SH9V3BE
DPST

CONTACT MATERIAL

OPTION CODE	CONTACT MATERIAL	TERMINAL PLATING	RATINGS	
B	GOLD ¹	GOLD ¹	LOW LEVEL/DRY CIRCUIT	0.4 VA MAX. @ 20 V AC OR DC MAX.
P		MATTE-TIN ⁶		
Q	SILVER ^{4,5}	SILVER ⁵	POWER	1 AMP @ 120 V AC OR 28 V DC.
G	GOLD OVER SILVER ^{2,3}	GOLD ³	LOW LEVEL/DRY CIRCUIT OR POWER	0.4 VA MAX @ 20 V AC OR DC MAX. OR 1 AMP @ 120 V AC OR 28 V DC.
R		MATTE-TIN ⁶		

* Note: See Technical Data section of this catalog for RoHS compliant and compatible definitions and specifications.

¹ CONTACTS & TERMINALS: Copper alloy, with gold plate over nickel plate.

² END CONTACTS: Coin silver, with gold plate over nickel plate.

³ CENTER CONTACTS & ALL TERMINALS: Copper alloy, with gold plate over nickel plate.

⁴ END CONTACTS: Coin silver, silver plated.

⁵ CENTER CONTACT & ALL TERMINALS: Copper alloy, silver plated.

⁶ TERMINALS: Copper alloy, with matte-tin over nickel plate.

NOTE: Any models supplied with P, R, Q, B or G contact material are RoHS compliant.

All models with all options when ordered with R, G, or Q contact material.

B contact material standard with A, AV, V3 & W terminations.

Q contact material standard with C & Z terminations

P, R contact materials not available with Z terminations.

SEAL

E EPOXY SEAL

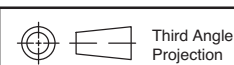
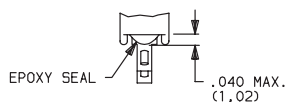

Dimensions are shown: Inches (mm)
Specifications and dimensions subject to change



TP Series Tiny Pushbutton Switches

Pushbutton

A

AVAILABLE HARDWARE

Cap, .100" DIA. Plungers

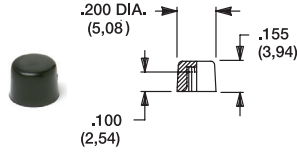

PART NO.

- 508101000** WHITE
- 508102000** BLACK

Material: Nylon
Finish: Gloss

Cap, .100" DIA. Plungers (Recommended for S9 plunger)

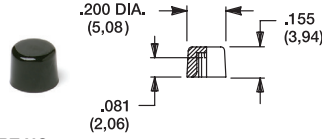

PART NO.

- 538701000** WHITE
- 538702000** BLACK

Material: Nylon
Finish: Gloss

Cap, .100" DIA. Plungers

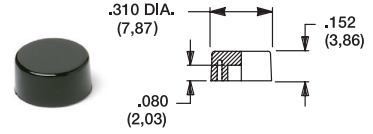

PART NO.

- 465801000** WHITE
- 465802000** BLACK

Material: Nylon
Finish: Gloss

Cap, .120" DIA. Plungers

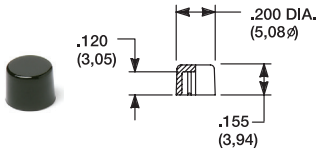

PART NO.

- 708901000** WHITE
- 708902000** BLACK

Material: Nylon
Finish: Gloss

Cap, .120" DIA. Plungers

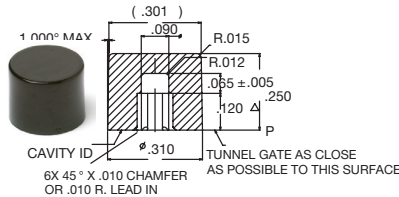

PART NO.

- 891D01000** WHITE
- 891D02000** BLACK

Material: Nylon
Finish: Gloss

Cap, J81 option only

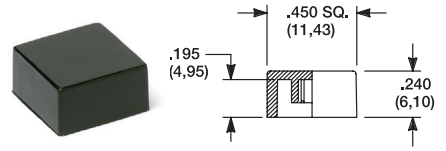

PART NO.

- 484601000** WHITE
- 484602000** BLACK

Material: Nylon
Finish: Gloss

PART NO.

- 798201000** WHITE
- 798202263** BLACK

Material: Nylon
Finish: Matte

NOTE: Additional nuts, locking rings and lockwashers available separately, see section "Technical Data and Additional Hardware". Other cap colors available, consult Customer Service Center.

Frames snap into panel opening and are independent from switch mounting. Accurate positioning of the PC mounted switch relative to the panel opening is necessary to provide proper clearance between actuator and frame. Available in two basic styles and four panel thicknesses .047-.125 in. Material: Nylon. Finish: Matte.

TYPICAL APPLICATION

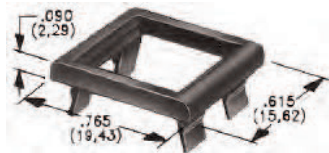
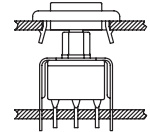

.090" (2,29) PANEL THK. .125" (3,18) PANEL THK.

PART NO.

- 432702263**

PART NO.

- 432802263** BLACK

PANEL MOUNTING

For part numbers
432502263, 432602263

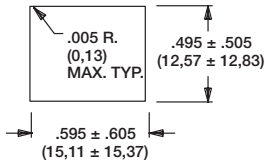

For part numbers
432702263, 432802263

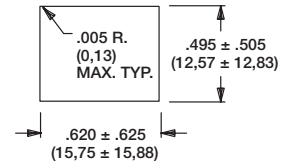

Panel Inserts

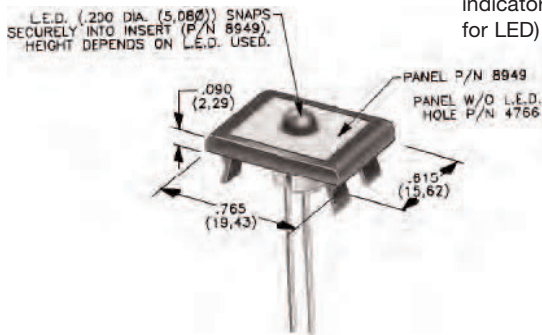

Above frames (part nos. 432XXXXXX) are also available with insert which accepts LED for indicator light assembly. Order insert separately from frame. Blank insert panel (without hole for LED) also available. LED not included.

PANEL INSERT
WITH HOLE FOR LED

- PART NO.**
894902000

BLANK PANEL INSERT
WITHOUT HOLE FOR LED

- PART NO.**
476602000 BLACK

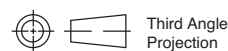

Dimensions are shown: Inches (mm)
Specifications and dimensions subject to change



5 Aug 20

X-ON Electronics

Largest Supplier of Electrical and Electronic Components

Click to view similar products for [Switch Bezels / Switch Caps](#) category:

Click to view products by [C&K](#) manufacturer:

Other Similar products are found below :

[896809000](#) [LW1A-B2-R](#) [LW2A-B1-G](#) [704.604.4](#) [704.955.3](#) [F1403](#) [7527](#) [760203000](#) [760503000](#) [766601000](#) [785105000](#) [785106000](#)
[MG12KB](#) [MH11](#) [MH13](#) [MHU31](#) [MJ1216](#) [MJ1226](#) [MJ33](#) [MJ612](#) [MJ626](#) [MJ627](#) [9001T8BK](#) [908-1634](#) [92-343.200](#) [92-343.400](#) [95804.920](#)
[95CAP-011](#) [95CAP-112](#) [11-932.7](#) [99-901.9](#) [99-902.9](#) [99-909.4](#) [99-909.5](#) [99-920.8](#) [A0261A](#) [11-931.2](#) [11-932.5](#) [11-936](#) [AKTSC22B](#)
[AT496H](#) [AW-RF8](#) [161006](#) [1825068-6](#) [184-1872](#) [187-1872](#) [188-1471](#) [18-920.1](#) [1DFBLK](#) [1D-GRY](#)