

8020 Series Snap-acting Momentary Pushbutton Switches



A

Pushbutton

Features/Benefits

- Positive tactile feel
- Multi-positions available
- Wide variety of termination options
- Epoxy terminal seal compatible with bottom wash cleaning
- RoHS compliant models available

Typical Applications

- Instrumentation
- Computer peripherals
- Telecommunications equipment

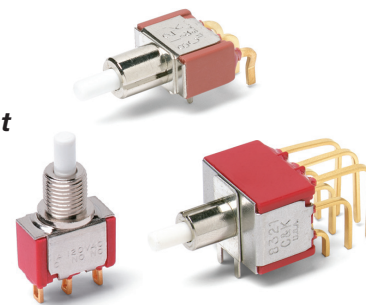

Models Available

Specifications

CONTACT RATING: B contact material (8X25 Models): 0.4 VA max. @ 20 V AC or DC maximum. G contact material (8X21, U8X1 Models): 1 AMP @ 120 V AC or 28 V DC or 0.4 VA max. @ 20 V AC or DC max. Note: Break-before-make contacts. Multi-pole contacts do not make and break simultaneously. See page A-43 for additional ratings.

ELECTRICAL LIFE: 60,000 make-and-break cycles at full load.

CONTACT RESISTANCE: Below 50 mΩ typ. initial @ 2-4 V DC, 100 mA, for both silver and gold plated contacts.

INSULATION RESISTANCE: 10⁹Ω min.

DIELECTRIC STRENGTH: 1,000 Vrms min. @ sea level.

OPERATING TEMPERATURE: 8X2X MODELS: -30°C to 75°C. U8X1 MODELS: -30°C to 85°C.

CAP INSTALLATION FORCE: 10 lbs. max. permissible.

SOLDERABILITY: Per MIL-STD-202F method 208D, or EIA RS-186E method 9 (1 hour steam aging).

NOTE: Any models supplied with B, P, R, or G contact material are RoHS compliant.

NOTE: Specifications and materials listed above are for switches with standard options. For information on specific and custom switches, consult Customer Service Center.

Materials

CASE: Glass filled nylon 6/6 or diallyl phthalate (DAP), flame retardant (UL 94V-0).

PLUNGER: Glass filled nylon or glass filled polyester (PBT) (UL 94V-0).

CAP & FRAME: Nylon, black, standard.

BUSHING: Brass or zinc, nickel plated.

HOUSING: Stainless steel.

SWITCH SUPPORT: Brass or steel, matte-tin plated.

N.O. & N.C. CONTACTS: 8X21, U8X1 MODELS: G contact material: Coin silver, with gold plate over nickel plate. See page A-43 for additional contact materials.

8X25 MODELS: B contact material: Copper alloy, with gold plate over nickel plate. See page A-43 for additional contact materials.

COMMON CONTACT & ALL TERMINALS: Copper alloy, with gold plate over nickel plate.

TERMINAL SEAL: Epoxy. Refer to soldering and cleaning Technical Data Chapter.

HARDWARE: Nut & Locking Ring: Brass, nickel plated; Lockwasher: Steel, nickel plated.

Build-A-Switch

To order, simply select desired option from each category and place in the appropriate box. Available options are shown and described on pages A-30 thru A-45. For additional options not shown in catalog, consult Customer Service Center. All models have epoxy terminal seal and are compatible with all "bottom-wash" PCB cleaning methods.



Switch Function

- 8121** SPDT On-Mom. 1 Amp
- 8125** SPDT On-Mom. 0.4VA
- 8221** DPDT On-Mom. 1 Amp
- 8225** DPDT On-Mom. 0.4VA
- 8321** 3PDT On-Mom. 1 Amp
- 8325** 3PDT On-Mom. 0.4VA
- 8421** 4PDT On-Mom. 1 Amp
- 8425** 4PDT On-Mom. 0.4VA

Actuator or Plunger

- S** Plunger
- NONE** Snap-in
- J80** Snap-in
- J81** Snap-in w/frame
- J82** Snap-in w/frame for LED
- J83** Snap-in w/frame & flush cap
- J84** Snap-in w/frame for LED, flush cap
- J85** Snap-in w/frame & LED
- J95** PC w/V-bracket & LED
- L** Plunger
- M** Snap-fitting plunger

Bushing

- D9** .280" high, keyway
- H** .250" high, flat
- NONE** No bushing choice required
- D** .280" high, keyway
- D2** .288" high, flat
- D3** .180" high
- D8** .288" high, flat
- H9** .250" high, flat, hi torque
- Y** .350" high, keyway
- Y3** 6.35mm high, keyway, hi torque
- Y4** .378" high, flat, hi torque
- Y9** .350" high, keyway

Contact Material

- B** Gold
- P** Gold, matte-tin
- G** Gold over silver
- R** Gold over silver, matte-tin

Seal

- E** Epoxy
- I** Epoxy potted base

Cap Color

- 2** Black
- NONE** Models without caps
- 1** White
- 3** Red
- 4** Orange
- 5** Yellow
- 6** Green
- 7** Blue
- 9** Gray

Frame Color

- 2** Black
- NONE** Models without frame
- 1** White
- 3** Red
- 5** Yellow
- 6** Green
- 9** Gray

LED Color

- 3** Red
- NONE** Models without LED
- 5** Yellow
- 6** Green

Terminations

- A** Right angle, PC thru-hole
- AV2** Vertical right angle, PC thru-hole
- C** PC Thru-hole
- Z** Solder lug
- A2** Right angle, PC thru-hole
- A3** Right angle, snap-in, PC thru-hole
- A4** Right angle, PC thru-hole, reversed terminals
- A6** Right angle, PC thru-hole
- AV1** Vertical right angle, PC thru-hole
- AV3** Vertical right angle, snap-in, PC thru-hole
- R** Right angle with PCB
- R2** Right angle with PCB, reversed terminals
- V2** .555" high, V-bracket
- V3** .460" high, V-bracket
- V4** .630" high, V-bracket
- V6** .460" high, V-bracket
- V7** .630" high, V-bracket
- V8** .953" high, V-bracket
- V9** 1.150" high, V-bracket
- V31** .460" high, snap-in V-bracket
- V61** .460" high, snap-in V-bracket
- W** .750" long, wire wrap
- W1** .964" long, wire wrap
- W3** .425" long, wire wrap
- W4** 1.062" long, wire wrap
- Z3** Quick connect

Note: UL models available, see page A-30 and A-31.

Dimensions are shown: Inches (mm)

Specifications and dimensions subject to change



29 Aug 18



8020 Series Snap-acting Momentary Pushbutton Switches

SWITCH FUNCTION

Pushbutton

NO. POLES	MODEL NO.	UL/CSA* MODEL NO.	SWITCH FUNCTION		CONNECTED TERMINALS		SCHEMATIC
			POS. 1	POS. 2	POS. 1	POS. 2	
SP	8121	U811	ON	MOM.	1-3	1-2	
	8125		ON	MOM.			
SPDT <p>Part number shown: 8121SHZGE</p>							
DP	8221	U821	ON	MOM.	1-3,4-6	1-2,4-5	
	8225		ON	MOM.			
DPDT <p>Part number shown: 8221SHZGE</p>							
3P	8321	U831	ON	MOM.	1-3,4-6,7-9	1-2,4-5,7-8	
	8325		ON	MOM.			
3PDT <p>Part number shown: 8321SHZGE</p>							

MOM. = Momentary

*U811 thru U841 model numbers with all options (except R, R2 terminations) when ordered with G or R contact material.

8X25 models must be ordered with B or P contact material.

8X21 and U8X1 models must be ordered with G or R contact material.

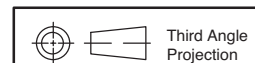

Dimensions are shown: Inches (mm)
Specifications and dimensions subject to change



29 Aug 18

8020 Series Snap-acting Momentary Pushbutton Switches



A Pushbutton

SWITCH FUNCTION

NO. POLES	MODEL NO.	UL/CSA* MODEL NO.	SWITCH FUNCTION		CONNECTED TERMINALS		SCHEMATIC
			POS. 1	POS. 2	POS. 1	POS. 2	
4P	8421	U841	ON	MOM.	1-3,4-6-7-9,10-12	1-2,4-5,7-8,10-11	
	8425		ON	MOM.			

4PDT

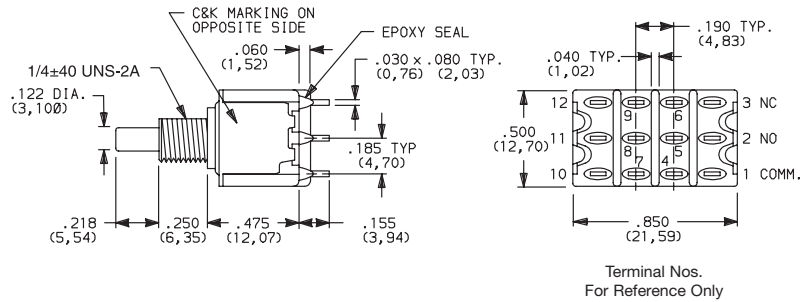

Part number shown: 8421SHZGE

MOM. = Momentary

* U811 thru U841 model numbers with all options (except R, R2 terminations) when ordered with G or R contact material.

8X25 models must be ordered with B or P contact material.

8X21 and U8X1 models must be ordered with G or R contact material.

ACTUATOR—SNAP-IN FRONT MOUNT

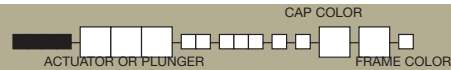

OPTION CODE	CAP AND FRAME COLOR
2	BLACK
NONE	No Frame Color (J80 option)
1	WHITE
3	RED
4	ORANGE
5	YELLOW
6	GREEN
7	BLUE
9	GRAY

Other colors available, consult Customer Service Center. Cap and Frame Finish: matte.

NOTE: Caps and frames available separately, see pages A-44 and A-45.

J80 SNAP-IN

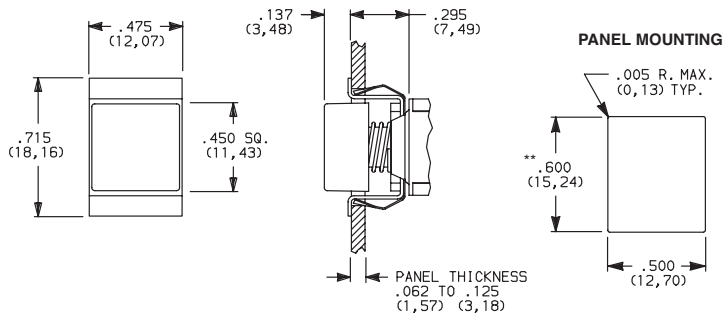

NOTE: No frame color choice required.

** Increase this dim. to .620/.625 (15,75/15,88) for .091/.125 (2,31/3,18) thk. panels.

J81 SNAP-IN WITH FRAME

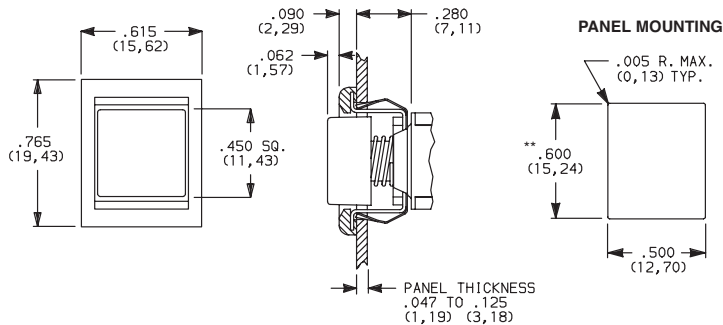

NOTE: Available with C, W-W4, Z or Z3 terminations and SPDT and DPDT models only.

** Increase this dim. to .620/.625 (15,75/15,88) for .091/.125 (2,31/3,18) thk. panels.

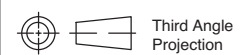

29 Aug 18



8020 Series Snap-acting Momentary Pushbutton Switches

ACTUATOR—SNAP-IN FRONT MOUNT

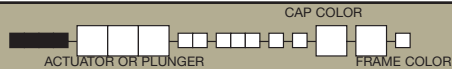

Pushbutton
A

J83 SNAP-IN WITH FRAME AND FLUSH CAP

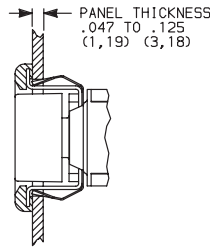
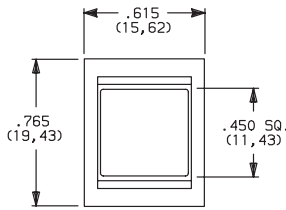

PANEL MOUNTING

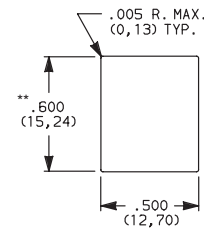

J82 SNAP-IN WITH FRAME FOR LED

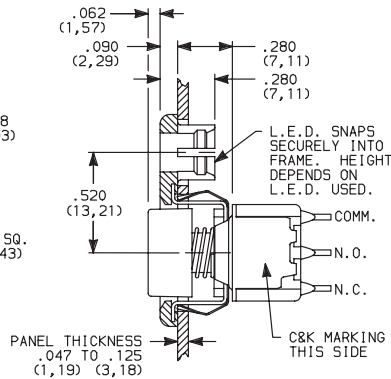
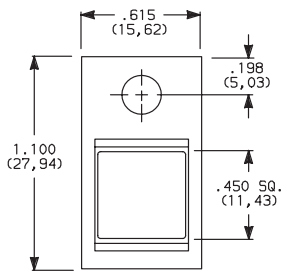
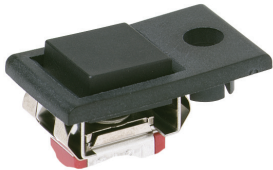

PANEL MOUNTING

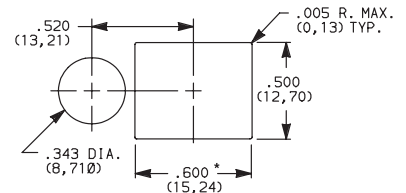

* Increase this dim. to .620/.625 (15,75/15,88) for .091/.125 (2,31/3,18) thk. panels.

LED not included.
For LED information, see page A-45.

J84 SNAP-IN WITH FRAME FOR LED, FLUSH CAP

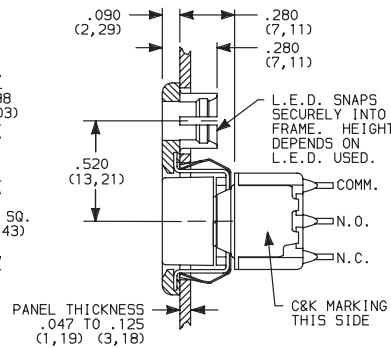
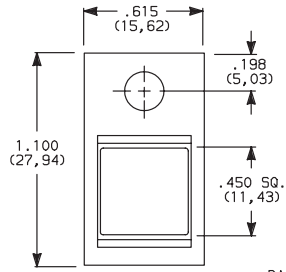
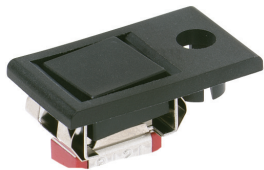

PANEL MOUNTING

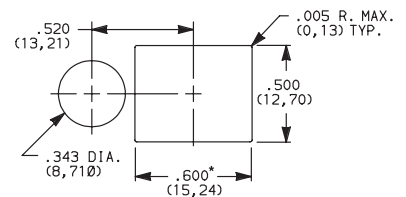

* Increase this dim. to .620/.625 (15,75/15,88) for .091/.125 (2,31/3,18) thk. panels.

LED not included.
For LED information, see page A-45.

OPTION CODE	CAP AND FRAME COLOR
2	BLACK
1	WHITE
3	RED
4	ORANGE
5	YELLOW
6	GREEN
7	BLUE
9	GRAY

Other colors available, consult Customer Service Center.
Cap and Frame Finish: matte.

Available with C, W-W4, Z or Z3 terminations and SPDT and DPDT models only.

NOTE: Caps and frames available separately, see pages A-44 and A-45.

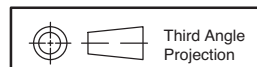

Dimensions are shown: Inches (mm)
Specifications and dimensions subject to change



29 Aug 18

8020 Series Snap-acting Momentary Pushbutton Switches



A Pushbutton

ACTUATOR—SNAP-IN FRONT MOUNT

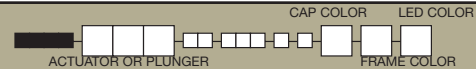

J85 SNAP-IN WITH FRAME AND LED

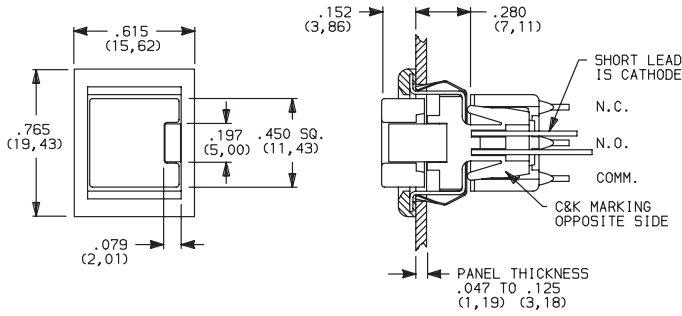

PANEL MOUNTING

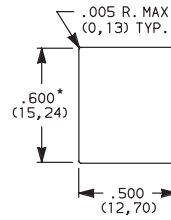

* Increase this dim. to .620/.625 (15,75/15,88) for .091/.125 (2,31/3,18) thk. panels.

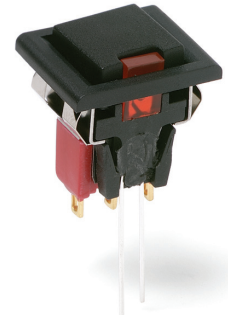

8121J85ZGE23 SPST

Available with C, W-W4, Z or Z3 terminations and SPDT models only. For LED information see page A-45.

NOTE: Caps & frames available separately, see pages A-44 and A-45.

OPTION CODE	CAP AND FRAME COLOR
2	BLACK
1	WHITE
3	RED
4	ORANGE
5	YELLOW
6	GREEN
7	BLUE
9	GRAY

OPTION CODE	LED COLOR
3	RED
5	YELLOW
6	GREEN

For LED information see page A-45.

ACTUATOR—PC MOUNT

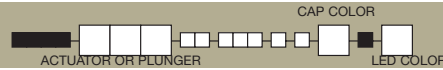

J95 PC WITH V-BRACKET AND LED

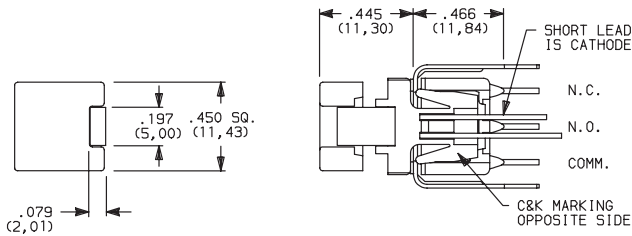

PC MOUNTING

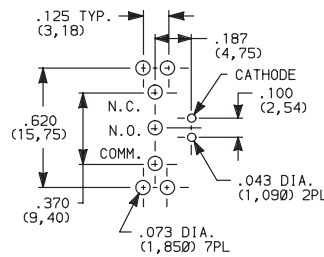

8121J95V3GE23 SPST

OPTION CODE	CAP AND FRAME COLOR
2	BLACK
1	WHITE
3	RED
4	ORANGE
5	YELLOW
6	GREEN
7	BLUE
9	GRAY

OPTION CODE	LED COLOR
3	RED
5	YELLOW
6	GREEN

For LED information see page A-45.

NOTE: Caps available separately, see page A-44. Available with V3 terminations and SPDT models only.

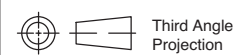



8020 Series Snap-acting Momentary Pushbutton Switches

Pushbutton

A

PLUNGER

ACTUATOR OR PLUNGER

S PLUNGER

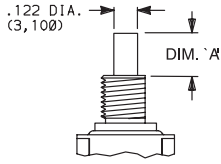

NONE NO PLUNGER CHOICE REQUIRED (JXX ACTUATORS)

AVAILABLE BUSHINGS	DIM. 'A' FOR C, W-W4, Z & Z3 TERMINATIONS	DIM. 'A' FOR A, A2, A3, A4, A6, AV-A3, R & R2 TERMINATIONS	DIM. 'A' FOR V3-V61 TERMINATIONS
D, D9	.244 (6,20)	.228 (5,79)	.224 (5,69)
H, H9	.218 (5,54)	.202 (5,13)	.198 (5,03)
Y, Y9	.203 (5,16)	.187 (4,75)	.183 (4,65)
Y3	(5,54)	(5,13)	(5,03)
Y4	.185 (4,70)	.169 (4,29)	.165 (4,19)
D2, D8	N/A	.232 (5,89)	.228 (5,79)
D3	N/A	.162 (4,11)	.158 (4,01)

L PLUNGER

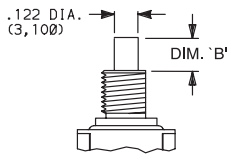

AVAILABLE BUSHINGS	DIM. 'B' FOR C, W-W4, Z & Z3 TERMINATIONS	DIM. 'B' FOR A, A2, A3, A4, A6, AV-A3, R & R2 TERMINATIONS	DIM. 'B' FOR V3-V61 TERMINATIONS
Y, Y9	.178 (4,52)	.162 (4,11)	.158 (4,01)
Y4	.090 (2,29)	.074 (1,88)	.070 (1,78)

M SNAP-FITTING PLUNGER

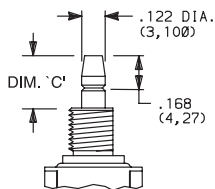

AVAILABLE BUSHINGS	DIM. 'C' FOR C, W-W4, Z & Z3 TERMINATIONS	DIM. 'C' FOR A, A2, A3, A4, A6, AV-A3, R & R2 TERMINATIONS	DIM. 'C' FOR V3-V61 TERMINATIONS
D, D9	.297 (7,54)	.281 (7,14)	.277 (7,04)
H, H9	.267 (6,78)	.251 (6,38)	.247 (6,27)
Y, Y9	.259 (6,58)	.243 (6,17)	.239 (6,07)
Y3	(6,78)	(6,37)	(6,27)
Y4	.259 (6,58)	.243 (6,17)	.239 (6,07)
D2, D8	N/A	.273 (6,93)	.269 (6,83)
D3	N/A	.361 (9,17)	.357 (9,07)

N/A = NOT AVAILABLE

NOTE: When selecting plunger option, bushing selection must also be made, see next page. No plunger option is required when any JXX actuator option is selected. Additional plunger lengths are available on SPDT and DPDT models, consult Customer Service Center. Not all plunger lengths sufficient for use with caps, see page A-44.

BUSHING

NONE NO BUSHING CHOICE REQUIRED (JXX ACTUATORS)

D .280" HIGH THREADED, KEYWAY
D9 .28034" HIGH UNTHREADED, KEYWAY

H .250"34 HIGH THREADED, FLAT
H9 .250"34 HIGH UNTHREADED, FLAT

Y .350" HIGH THREADED, KEYWAY
Y9 .350" HIGH UNTHREADED, KEYWAY

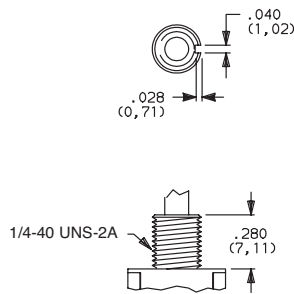

D9 bushing standard with A-A6, R, R2 AV-AV3 terminations.

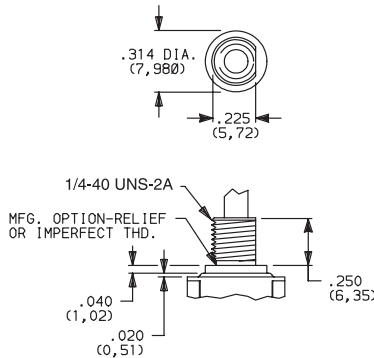

H bushing standard with C, W-W4, Z or Z3 terminations. H, H9 bushings not available on single pole models with A3-A6, R, R2 terminations. Will withstand 12 in./lbs. of torque with no distortion.

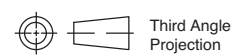
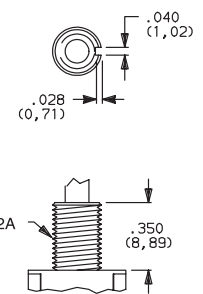

Dimensions are shown: Inches (mm)

Specifications and dimensions subject to change



8020 Series Snap-acting Momentary Pushbutton Switches



A Pushbutton

BUSHING

Y3 6.35mm THREADED, KEYWAY

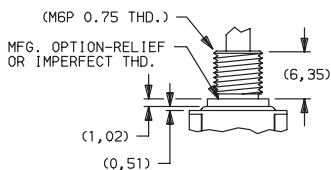
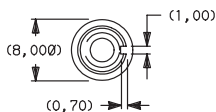

Y4 .378" HIGH THREADED, FLAT

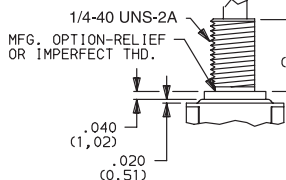
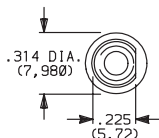

D2 .288" HIGH THREADED, FLAT

D8 .288" HIGH UNTHREADED, FLAT

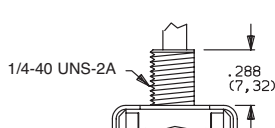

D3 .180" HIGH UNTHREADED

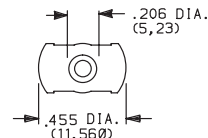

Y3 & Y4 bushings not available on single pole models with A3-A6, R, R2 terminations. Will withstand 12 in./lbs. of torque with no distortion.

D2, D8 bushings not available with C, W-W4, Z, Z3 terminations.

D3 bushing available with A, A2, A3, AV, AV2, AV3 and V2-V61 terminations only.

NOTE: No bushing option choice required when JXX actuator option is selected. When selecting bushing option, plunger selection must also be made, see previous page. Plunger lengths vary with bushing and termination options selected.

PANEL MOUNTING

1/4 INCH BUSHING

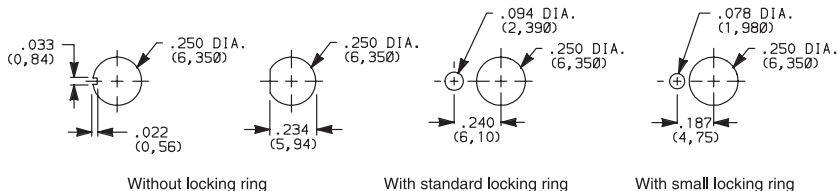

METRIC BUSHING

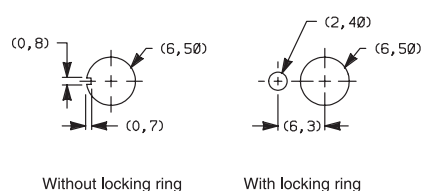

NOTE: Two mounting nuts, locking ring and lockwasher supplied standard with threaded bushings. Optional mounting nut and locking ring styles available, see section "Technical Data and Additional Hardware".

TERMINATIONS

Z SOLDER LUG

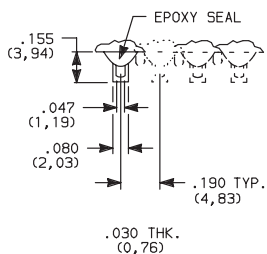

Not available with J95 actuator, P or R contact material.

SPDT thru 4PDT

C PC THRU-HOLE

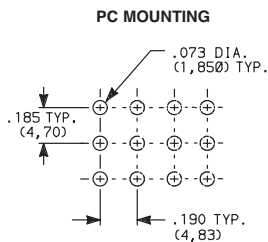
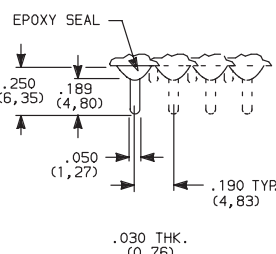

Not available with J95 actuator option.

SPDT thru 4PDT

Z3 QUICK CONNECT

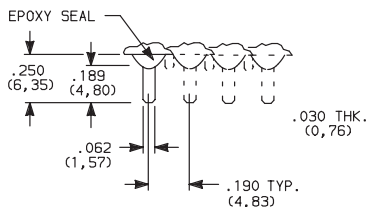

Not available with J95 actuator, P or R contact material. Mating quick connector available, order part number 530100000, page A-44.

SPDT thru 4PDT

W W1, W3, W4 WIRE WRAP

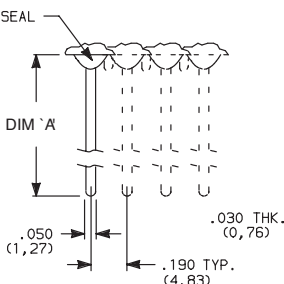

OPTION CODE	DIM 'A'
W	.750 (19,05)
W1	.964 (24,49)
W3	.425 (10,80)
W4	1.062 (26,97)

Not available with J95 actuator option.

SPDT thru 4PDT

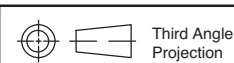

29 Aug 18

Dimensions are shown: Inches (mm)
Specifications and dimensions subject to change



8020 Series Snap-acting Momentary Pushbutton Switches

TERMINATIONS



Pushbutton

A

A RIGHT ANGLE, PC THRU-HOLE

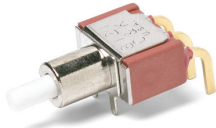

8121SD9AGE
SPDT

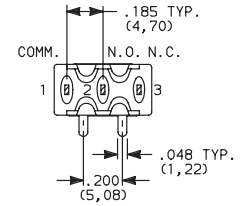
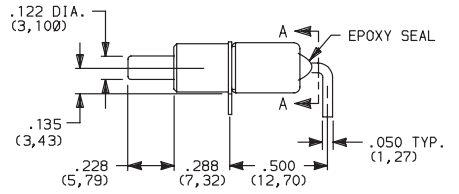
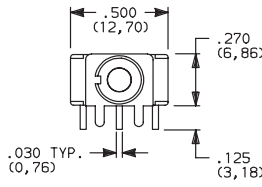

SECTION A-A

Terminal Nos.
For Reference Only.

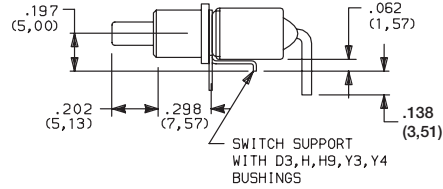

Part Number 8121SH9AGE

A3 RIGHT ANGLE, SNAP-IN, PC THRU-HOLE

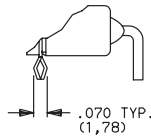
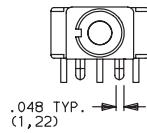

PC MOUNTING

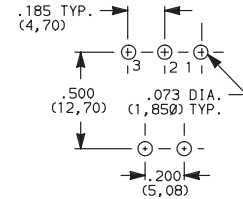

Not available with JXX actuators and I seal.
Terminal bend radii and lead-in manufacturing option.

A RIGHT ANGLE, PC THRU-HOLE

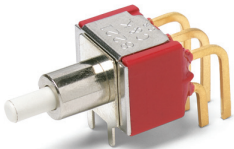

8221SD9AGE
DPDT

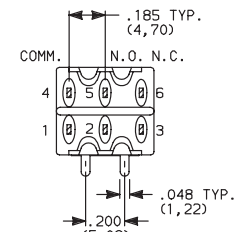
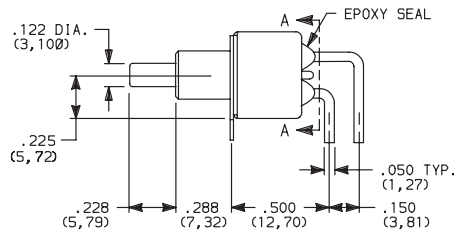
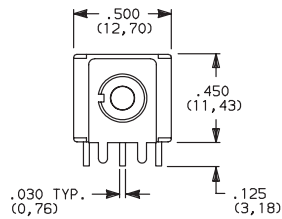

SECTION A-A

A3 RIGHT ANGLE, SNAP-IN, PC THRU-HOLE

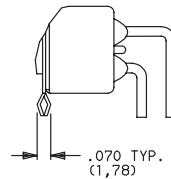
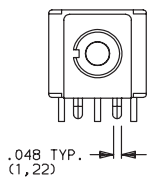

PC MOUNTING

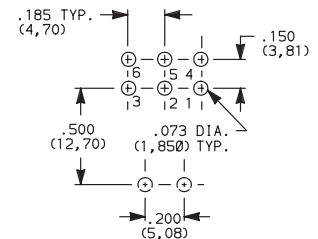

Not available with JXX actuators and I seal option.
Terminal bend radii and lead-in manufacturing option.



29 Aug 18

Dimensions are shown: Inches (mm)
Specifications and dimensions subject to change

8020 Series Snap-acting Momentary Pushbutton Switches



A Pushbutton

TERMINATIONS

A RIGHT ANGLE, PC THRU-HOLE

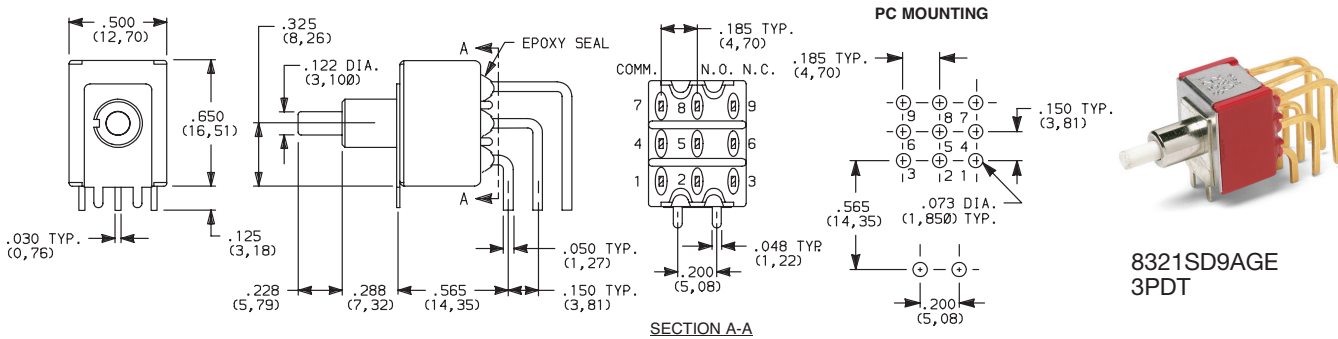

Not available with JXX actuators and I seal option.
Terminal bend radii and lead-in manufacturing option.

A2 RIGHT ANGLE, PC THRU-HOLE

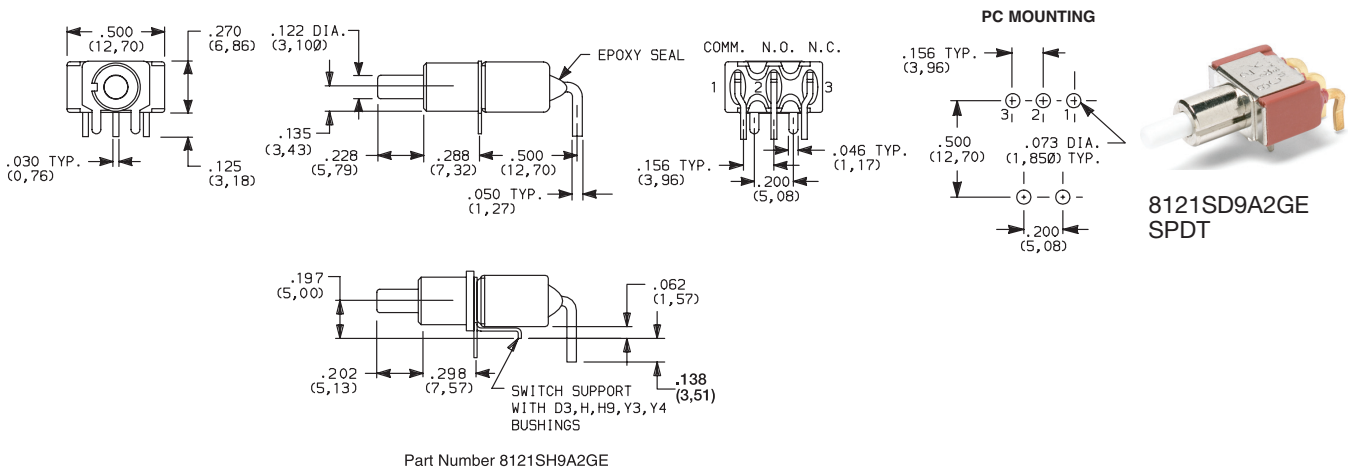

Not available with JXX actuators, I seal option.
Terminal bend radii and lead-in manufacturing option.

A4 RIGHT ANGLE, PC THRU-HOLE, REVERSED TERMINALS

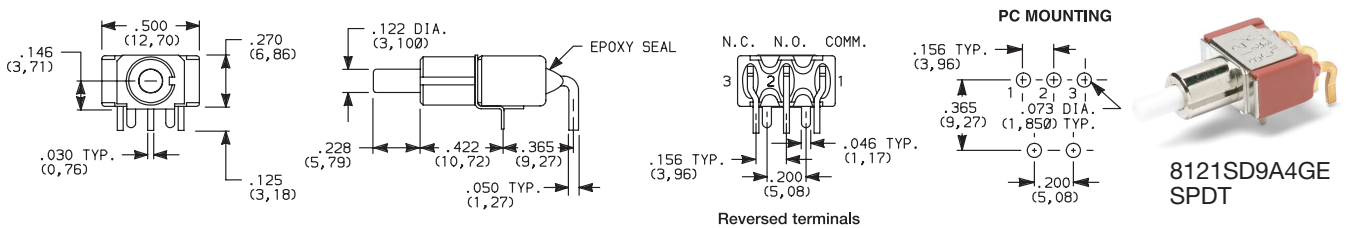

Not available with JXX actuators, D3, H, H9, Y3, Y4 bushings and I seal.
Terminal bend radii and lead-in manufacturing option.

The A4 and R2 termination options are functionally identical and fit the same PC mounting pattern. The switches, however, are shifted relative to the mounting holes. The PC pattern must clear the switch support legs. Unlike the R2, the A4 option is available with UL/CSA.

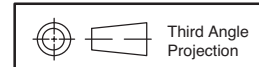

Dimensions are shown: Inches (mm)
Specifications and dimensions subject to change



29 Aug 18



8020 Series Snap-acting Momentary Pushbutton Switches

TERMINATIONS



Pushbutton

A

A6 RIGHT ANGLE, PC THRU-HOLE

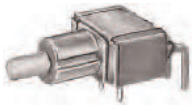

8121SD9A6GE
SPDT

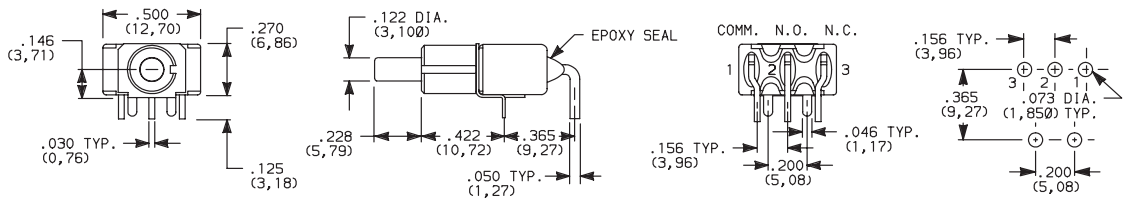

The A6 and R termination options are functionally identical and fit the same PC mounting pattern. The switches, however, are shifted relative to the mounting holes. The PC pattern must clear the switch support legs. Unlike the R, the A6 option is available with UL/CSA.

Not available with JXX actuators, D3, H, H9, Y3, Y4 bushings and I seal. Terminal bend radii and lead-in manufacturing option.

R RIGHT ANGLE WITH PCB

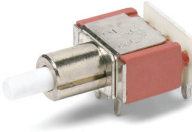

8121SD9RGE
SPDT

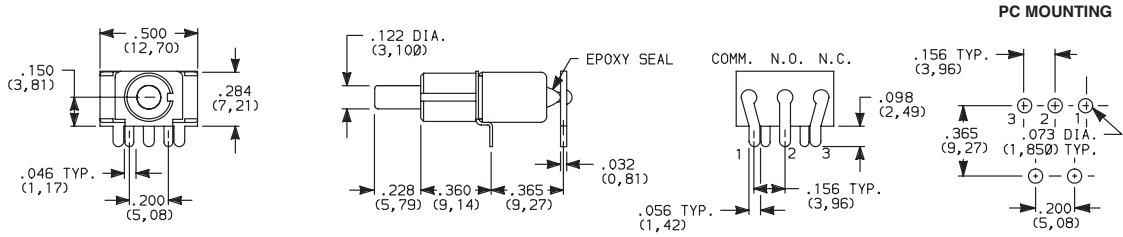

Not available with JXX actuators, D3, H, H9, Y3, Y4 bushings, I seal option. R termination not UL/CSA approved.

R2 RIGHT ANGLE WITH PCB, REVERSED TERMINALS

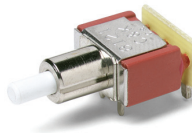

8121SD9R2GE
SPDT

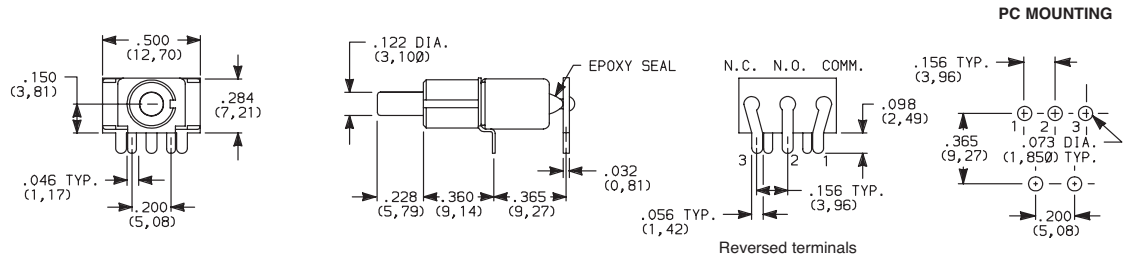

Not available with JXX actuators, D3, H, H9, Y3, Y4 bushings, I seal option. R2 termination not UL/CSA approved.

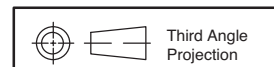

Third Angle
Projection



29 Aug 18

Dimensions are shown: Inches (mm)
Specifications and dimensions subject to change

8020 Series Snap-acting Momentary Pushbutton Switches



A Pushbutton

TERMINATIONS

AV2 VERTICAL RIGHT ANGLE, PC THRU-HOLE, .150" PITCH

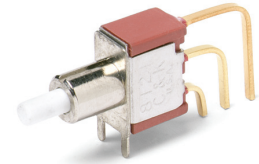
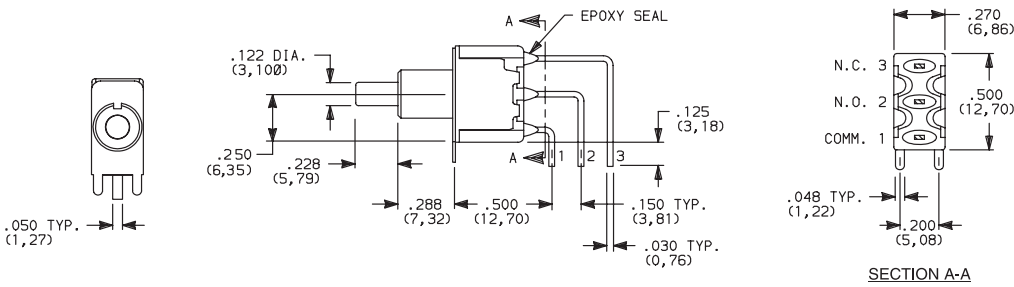

8121SD9AV2GE SPDT

AV3 VERTICAL RIGHT ANGLE, SNAP-IN, PC THRU-HOLE, .150" PITCH

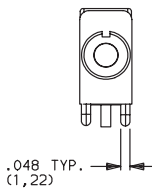

AV1 VERTICAL RIGHT ANGLE, EXTENDED, PC THRU-HOLE, .150" PITCH

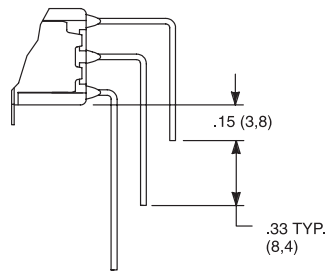

PC MOUNTING

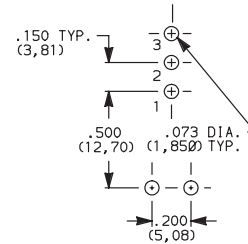

Not available with JXX actuators and I seal.
Terminal bend radii and lead-in manufacturing option.

AV2 VERTICAL RIGHT ANGLE, PC THRU-HOLE, .150" PITCH

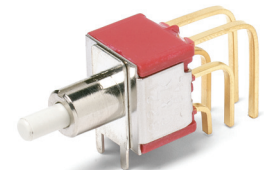
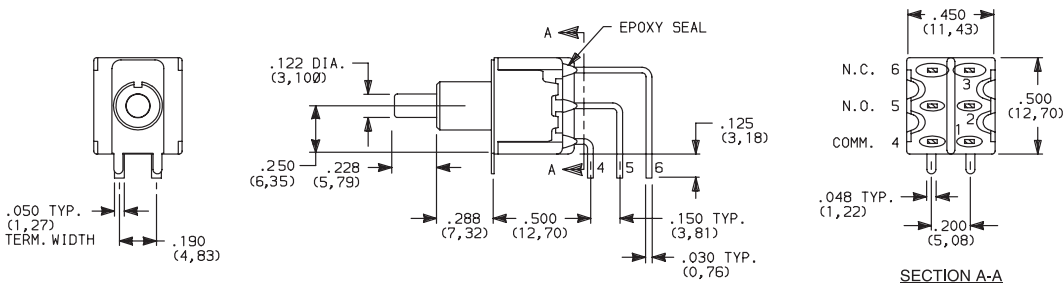

8221SD9AV2GE DPDT

AV3 VERTICAL RIGHT ANGLE, SNAP-IN, PC THRU-HOLE, .150" PITCH

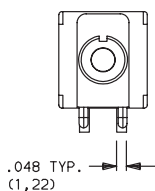

AV1 VERTICAL RIGHT ANGLE, EXTENDED, PC THRU-HOLE, .150" PITCH

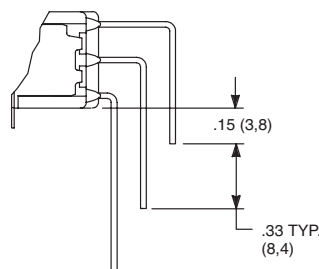

PC MOUNTING

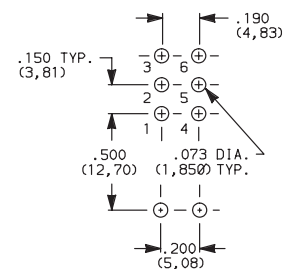

Not available with JXX actuators and I seal.
Terminal bend radii and lead-in manufacturing option.

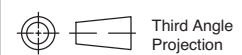

29 Aug 18

Dimensions are shown: Inches (mm)
Specifications and dimensions subject to change



8020 Series Snap-acting Momentary Pushbutton Switches

TERMINATIONS



Pushbutton

A

AV2 VERTICAL RIGHT ANGLE, PC THRU-HOLE, 150° PITCH

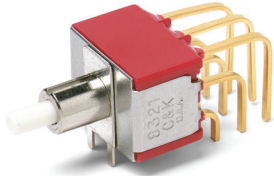

8321SD9AV2GE
3PDT

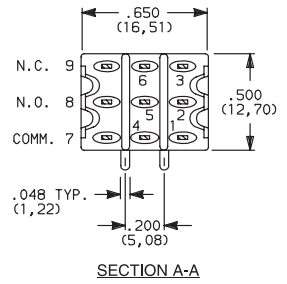
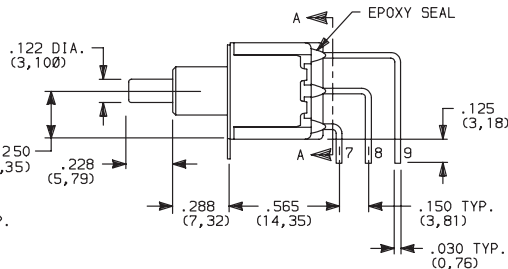
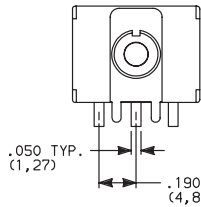

AV3 VERTICAL RIGHT ANGLE, SNAP-IN, PC THRU-HOLE, .150° PITCH

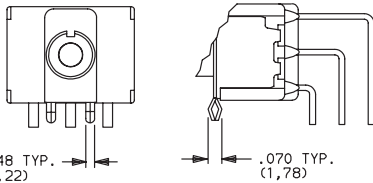

AV1 VERTICAL RIGHT ANGLE, EXTENDED, PC THRU-HOLE, .150° PITCH

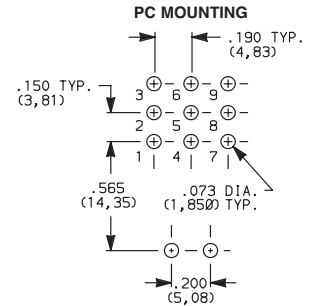
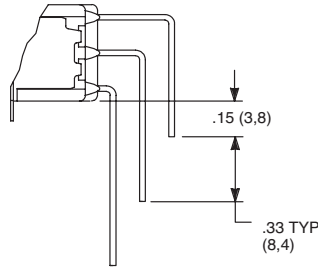

Not available with JXX actuators and I seal.
Terminal bend radii and lead-in manufacturing option.

AV2 VERTICAL RIGHT ANGLE, PC THRU-HOLE, 150° PITCH

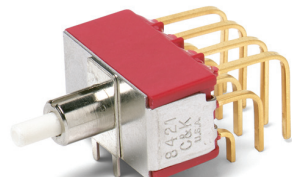

8421SD9AV2GE
4PDT

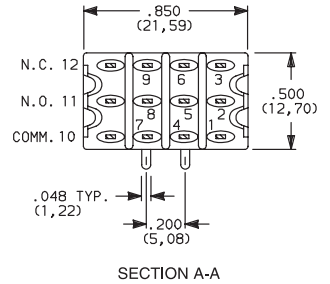
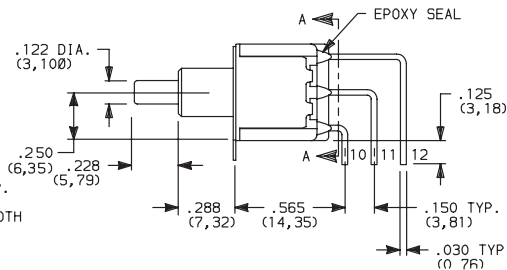
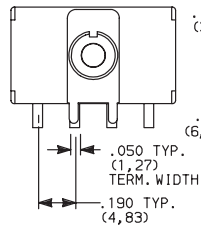

AV3 VERTICAL RIGHT ANGLE, SNAP-IN, PC THRU-HOLE, .150° PITCH

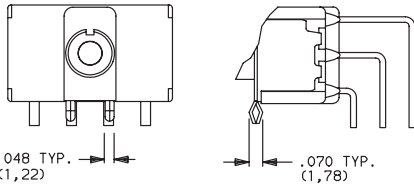

AV1 VERTICAL RIGHT ANGLE, EXTENDED, PC THRU-HOLE, .150° PITCH

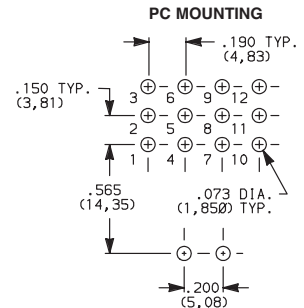
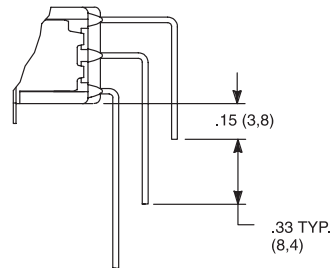

Not available with JXX actuators and I seal.
Terminal bend radii and lead-in manufacturing option.

V2, V6, V7, V8 VERTICAL MOUNT, V-BRACKET

V61 VERTICAL MOUNT, V-BRACKET, SNAP-IN

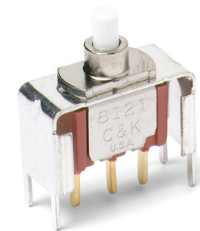

8121SD3_GE
SPDT

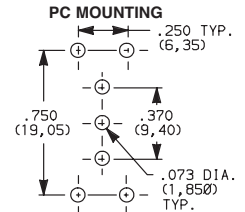
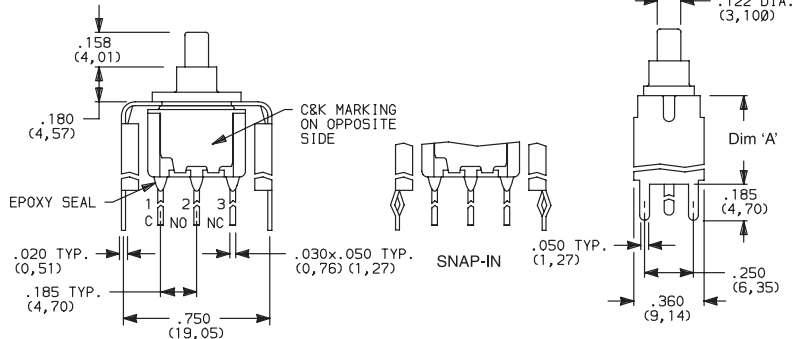

OPTION CODE	DIM 'A'
V2	.555 (14,10)
V6, V61	.460 (11,68)
V7	.630 (16,00)
V8	.953 (24,21)

Not available with JXX actuators and I seal.

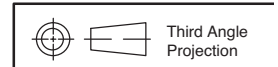

29 Aug 18

8020 Series Snap-acting Momentary Pushbutton Switches



A Pushbutton

TERMINATIONS

V2, V6, V7, V8 VERTICAL MOUNT, V-BRACKET

V61 VERTICAL MOUNT, V-BRACKET, SNAP-IN

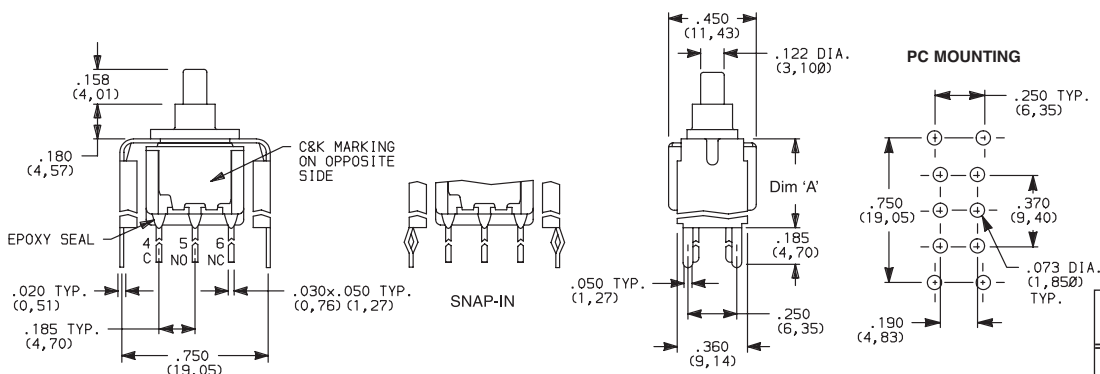

Not available with JXX actuators and I seal.

V2, V7, V8 VERTICAL MOUNT, V-BRACKET

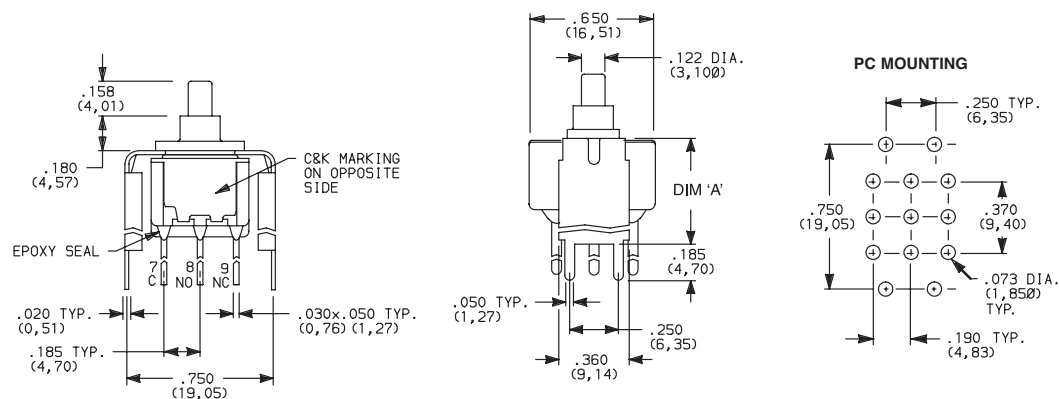

Not available with JXX actuators and I seal.

V2, V7, V8 VERTICAL MOUNT, V-BRACKET

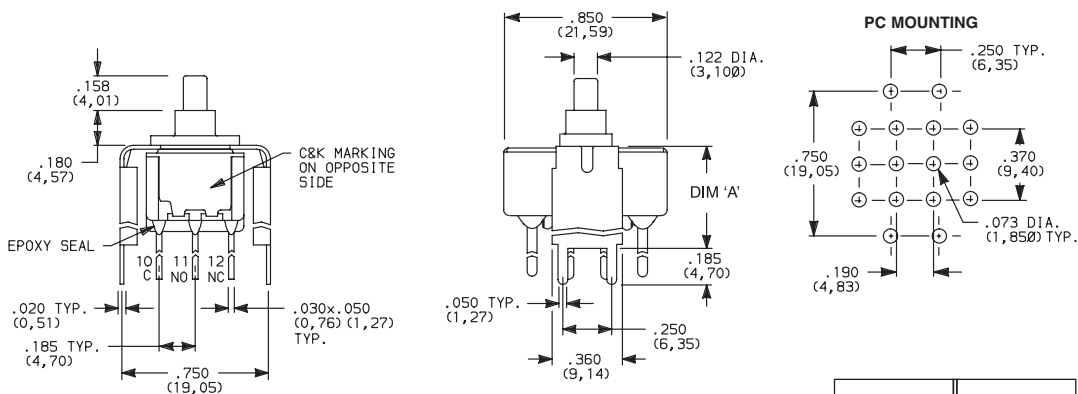

Not available with JXX actuators and I seal.



29 Aug 18

Dimensions are shown: Inches (mm)
Specifications and dimensions subject to change



8020 Series Snap-acting Momentary Pushbutton Switches

TERMINATIONS



Pushbutton

A

V3, V4, V9 VERTICAL MOUNT, V-BRACKET

V31 VERTICAL MOUNT, V-BRACKET, SNAP-IN

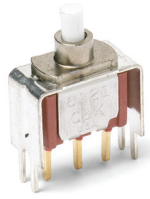

8121SD3_GE
SPDT

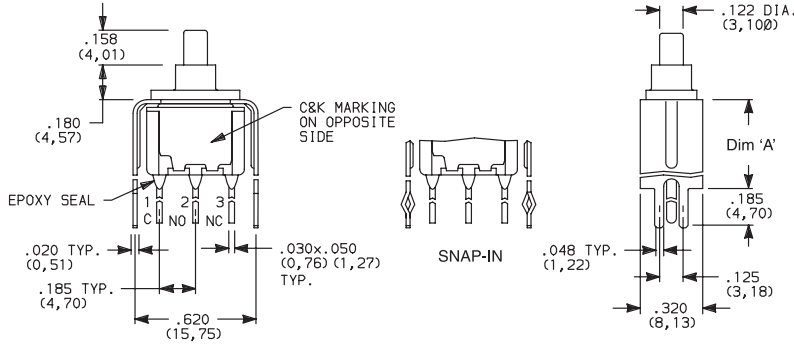

PC MOUNTING

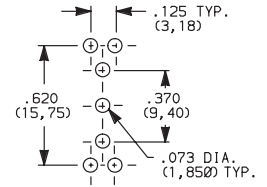

OPTION CODE	DIM 'A'
V3, V31	.460 (11,68)
V4	.630 (16,00)
V9	1.150 (29,21)

Not available with J8X actuators and I seal.

V3, V4, V9 VERTICAL MOUNT, V-BRACKET

V31 VERTICAL MOUNT, V-BRACKET, SNAP-IN

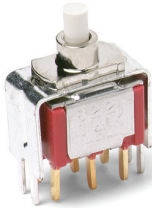

8221SD3_GE
DPDT

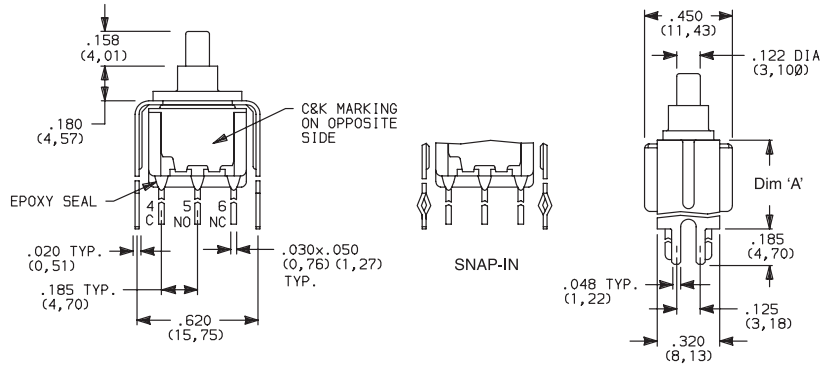

PC MOUNTING

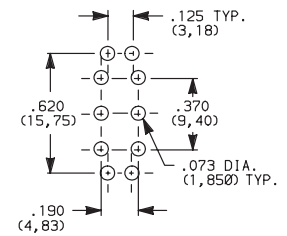

OPTION CODE	DIM 'A'
V3, V31	.460 (11,68)
V4	.630 (16,00)
V9	1.150 (29,21)

Not available with J8X actuators and I seal.

V4, V9 VERTICAL MOUNT, V-BRACKET

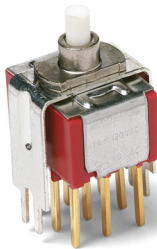

8321SD3V4GE
3PDT

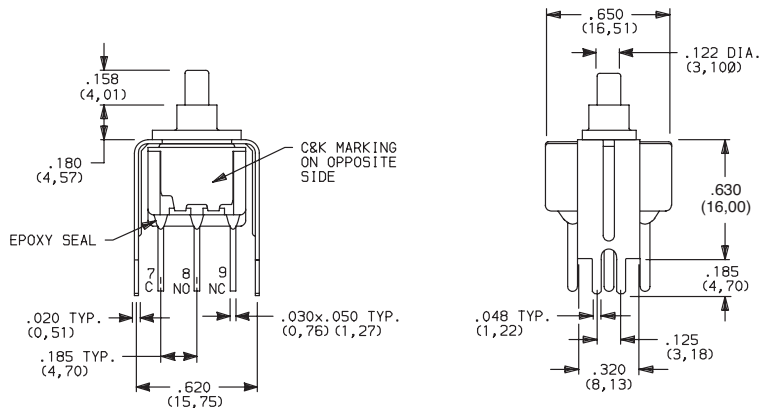

PC MOUNTING

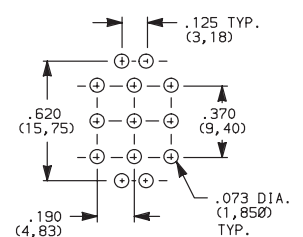

OPTION CODE	DIM 'A'
V4	.630 (16,00)
V9	1.150 (29,21)

Not available with JXX actuators and I seal.



29 Aug 18

Dimensions are shown: Inches (mm)
Specifications and dimensions subject to change

8020 Series Snap-acting Momentary Pushbutton Switches



A Pushbutton

TERMINATIONS

V4, V9 VERTICAL MOUNT, V-BRACKET

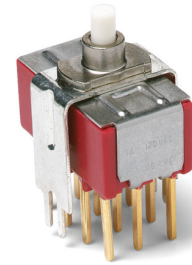
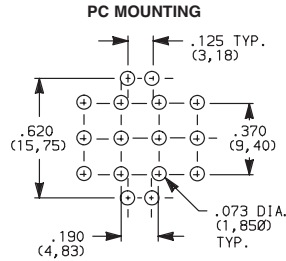
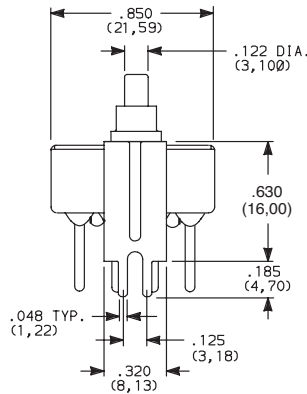
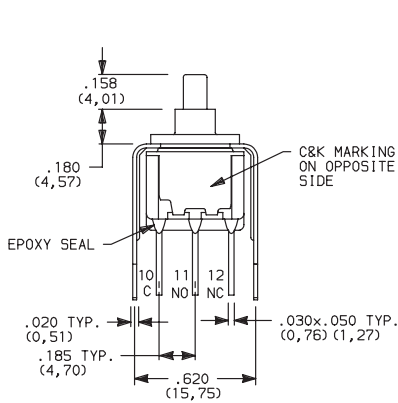

8421SD3V4GE
4PDT

OPTION CODE	DIM 'A'
V4	.630 (16,00)
V9	1.150 (29,21)

Not available with JXX actuators and I seal.

CONTACT MATERIAL

OPTION CODE	CONTACT MATERIAL	TERMINAL PLATING	RATINGS	
B	GOLD ¹	GOLD ¹	LOW LEVEL/DRY CIRCUIT	8x25 MODELS ONLY: 0.4 MAX. @ 20 V AC OR DC MAX.
P		MATTE-TIN ⁴		
G	GOLD OVER SILVER ^{2,3}	GOLD ³	LOW LEVEL/DRY CIRCUIT OR POWER	8X21, U8X1 MODELS ONLY: 0.4 VA MAX @ 20 V AC OR DC MAX. OR 1 AMP @ 120 V AC OR 28 V DC.
R		MATTE-TIN ⁴		

* Note: See Technical Data section of this catalog for RoHS compliant and compatible definitions and specifications.

- ¹ ALL CONTACTS & TERMINALS: Copper alloy, with gold plate over nickel plate.
- ² N.O. AND N.C. CONTACTS: Coin silver, with gold plate over nickel plate.
- ³ COMMON CONTACTS & ALL TERMINALS: Copper alloy, with gold plate over nickel plate.
- ⁴ TERMINALS: Copper alloy, with matte-tin over nickel plate.

NOTE: Any models supplied with B, P, R or G contact material are RoHS compliant.

U811-U841 models with all options (except R, R2 terminations) when ordered with mandatory G or R contact material.

B or P contact material must be ordered with 8X25 models.

G or R contact material must be ordered with 8X21, U8X1 models.

P or R contact material not available with Z, Z3 terminations.

SEAL

E EPOXY SEAL

I EPOXY POTTED BASE

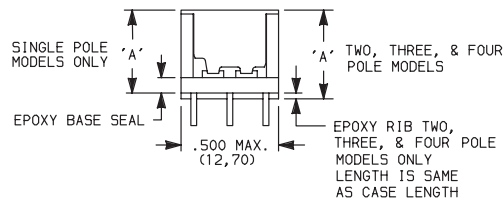
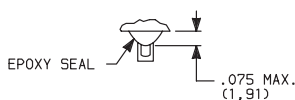

NO. POLES	DIM 'A'
SP	.410 (10,41)
DP	.440 (11,18)
3P	.505 (12,83)
4P	.505 (12,83)

NOTE: Available with C, W-W4, Z, Z3 terminations only.

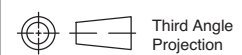

29 Aug 18

Dimensions are shown: Inches (mm)
Specifications and dimensions subject to change



8020 Series Snap-acting Momentary Pushbutton Switches

Pushbutton

A

AVAILABLE HARDWARE

Cap

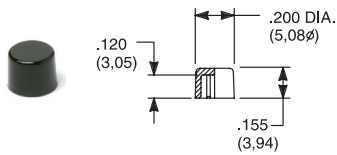

PART NO.

- 708901000** WHITE
- 708902000** BLACK
- 708903000** RED
- 708904000** ORANGE
- 708905000** YELLOW
- 708906000** GREEN
- 708907000** BLUE
- 708909000** GRAY

Material: Nylon
Finish: Gloss

Cap

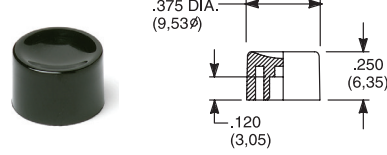

PART NO.

- 752701000** WHITE
- 752702000** BLACK
- 752703000** RED
- 752704000** ORANGE
- 752705000** YELLOW
- 752706000** GREEN
- 752707000** BLUE
- 752709000** GRAY

Material: Nylon
Finish: Gloss

Cap

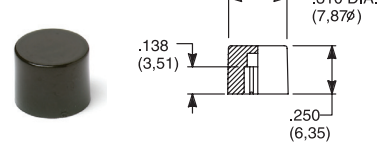

PART NO.

- 801801000** WHITE
- 801802000** BLACK
- 801803000** RED
- 801804000** ORANGE
- 801805000** YELLOW
- 801806000** GREEN
- 801807000** BLUE
- 801809000** GRAY

Material: Nylon
Finish: Gloss

Cap, Snap-fitting plunger

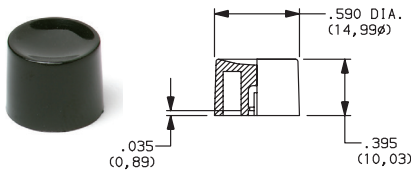

PART NO.

- 452D01000** WHITE
- 452D02000** BLACK
- 452D03000** RED
- 452D04000** ORANGE
- 452D05000** YELLOW
- 452D06000** GREEN
- 452D07000** BLUE
- 452D09000** GRAY

Material: Nylon
Finish: Gloss

Cap, Snap-fitting plunger

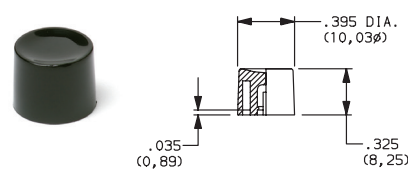

PART NO.

- 894101000** WHITE
- 894102000** BLACK
- 894103000** RED
- 894104000** ORANGE
- 894105000** YELLOW
- 894106000** GREEN
- 894107000** BLUE
- 894109000** GRAY

Material: Nylon
Finish: Gloss

Cap, J80, J81, J82, J83 & J84 options only

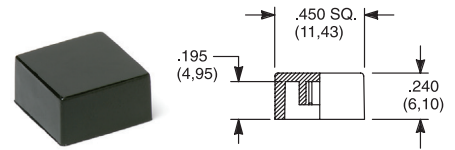

PART NO.

- 484601000** WHITE
- 484602000** BLACK
- 484603000** RED
- 484604000** ORANGE
- 484605000** YELLOW
- 484606000** GREEN
- 484607000** BLUE
- 484609000** GRAY

Material: Nylon
Finish: Gloss

PART NO.

- 798201000** WHITE
- 798202263** BLACK
- 798203000** RED
- 798204000** ORANGE
- 798205000** YELLOW
- 798206000** GREEN
- 798207000** BLUE
- 798209000** GRAY

Material: Nylon
Finish: Matte

Frame



PART NO.

- 615602263** BLACK

Material: Nylon
Finish: Matte

Frame



PART NO.

- 613302263** BLACK

Material: Nylon
Finish: Matte

Cap, J85 & J95 options only

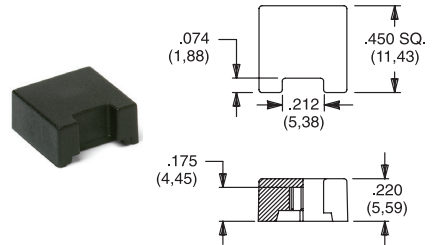

PART NO.

- 459701000**
- 459702000**
- 459703000**
- 459704000**
- 459705000**
- 459706000**
- 459707000**
- 459709000**

Material: Nylon
Finish: Matte

Fits Z3 Termination female connector

- PART NO.**
530100000

Available in loose pieces.



NOTE: Additional nuts, locking rings and lockwashers available separately, see section "Technical Data and Additional Hardware".

Other cap & frame colors available, consult Customer Service Center.

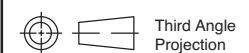

Dimensions are shown: Inches (mm)
Specifications and dimensions subject to change

8020 Series Snap-acting Momentary Pushbutton Switches



A Pushbutton

AVAILABLE HARDWARE

Frames snap into panel opening and are independent from switch mounting. Accurate positioning of the PC mounted switch relative to the panel opening is necessary to provide proper clearance between actuator and frame. Available in two basic styles and four panel thicknesses .047-.125 in. Material: Nylon. Finish: Matte.

TYPICAL APPLICATION

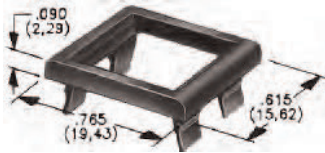
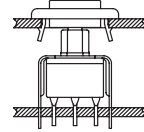

.090" (2,29) PANEL THK. .125" (3,18) PANEL THK.

PART NO.
432702263

PART NO.
432802263 BLACK

PANEL MOUNTING

For part numbers
4325xxxxx, 4326xxxxx

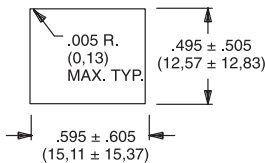

For part numbers
4327xxxxx, 4328xxxxx

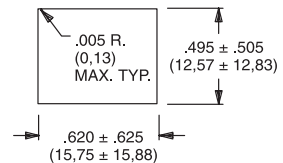

Panel Inserts

Above frames (part nos. 432XXXXXX) are also available with insert which accepts LED for indicator light assembly. Order insert separately from frame. Blank insert panel (without hole for LED) also available. LED not included.

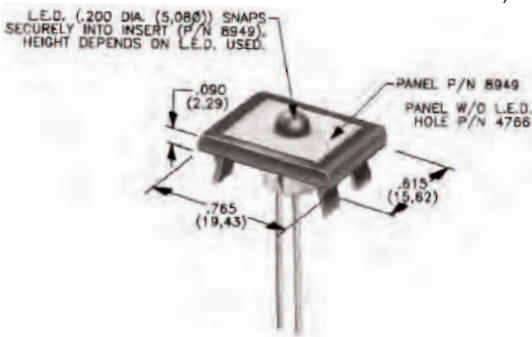

PANEL INSERT
WITH HOLE FOR LED

PART NO.
894902000

BLANK PANEL INSERT
WITHOUT HOLE FOR LED

PART NO.
476602000 BLACK

Special colors, custom markings available, consult Customer Service Center.

LED INFORMATION

SWITCHES WITH LED SUPPLIED: J85, J95 OPTIONS:

Rectangular LEDs are supplied on 8020 Series pushbutton switches with J85 and J95 options. These LEDs are factory installed and are not replaceable. The following specifications apply:

OPTION CODE	COLOR	TYP. INTENSITY	TYP. FORWARD VOLTAGE	TYP. FORWARD CURRENT	MAX RATINGS AT 25°C AMBIENT TEMPERATURE		
					FORWARD VOLTAGE	CONTINUOUS FORWARD CURRENT	POWER DISSIPATION
6	Green	1.0 mcd	2.1 V	20 mA	2.5 V	50 mA	125 mW
3	Red*	0.5 mcd		10 mA		30 mA	75 mW
5	Yellow	4.0 mcd		20 mA		50 mA	125 mW

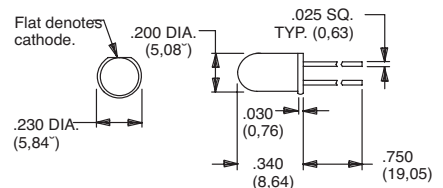

Suggested LED for J82 & J84 options.
Dimensions for reference only.

Process Information: Soldering to LED leads must be completed within 5 seconds at 500°F (260°C) maximum.

Caution: Circuit elements must limit forward current of LED to 50mA max. continuous.
* Extra-bright red LED available (typ. intensity 4.5 mcd), consult Customer Service Center.
LEDs are not supplied with J82, J84 options. LED snaps into switch frame surrounding actuator and is wired externally.

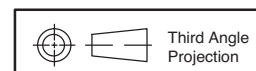

Dimensions are shown: Inches (mm)
Specifications and dimensions subject to change



29 Aug 18

X-ON Electronics

Largest Supplier of Electrical and Electronic Components

Click to view similar products for [Switch Bezels](#) / [Switch Caps](#) category:

Click to view products by [C&K](#) manufacturer:

Other Similar products are found below :

[896809000](#) [LW1A-B2-R](#) [LW2A-B1-G](#) [704.604.4](#) [704.955.3](#) [F1403](#) [7527](#) [760203000](#) [760503000](#) [766601000](#) [785105000](#) [785106000](#)
[MG12KB](#) [MH11](#) [MH13](#) [MHU31](#) [MJ1216](#) [MJ1226](#) [MJ33](#) [MJ612](#) [MJ626](#) [MJ627](#) [9001T8BK](#) [908-1634](#) [92-343.200](#) [92-343.400](#) [95804.920](#)
[95CAP-011](#) [95CAP-112](#) [11-932.7](#) [99-901.9](#) [99-902.9](#) [99-909.4](#) [99-909.5](#) [99-920.8](#) [A0261A](#) [11-931.2](#) [11-932.5](#) [11-936](#) [AKTSC22B](#)
[AT496H](#) [AW-RF8](#) [161006](#) [1825068-6](#) [184-1872](#) [187-1872](#) [188-1471](#) [18-920.1](#) [1DFBLK](#) [1D-GRY](#)