

**UL** models available, see page D-33.

**Easy Build-A-Switch:**

Below is a complete listing of available options for 8020 SERIES SNAP-ACTING MOMENTARY PUSHBUTTON SWITCHES. Build-A-Switch allows you to mix and match options to create the switch you need—simply select desired option from each category. Switches with standard options are shown on page D-32; all available options are shown and described on pages D-33 thru D-46. When building a part number, some ordering format boxes may not be filled. Dashes, hyphens or spaces in the part number are not significant, and are shown for clarity only. Complete HOW TO ORDER information is at the end of this section, page D-46. Hardware and accessories are available separately, see catalog section H. All models have epoxy terminal seal, and are compatible with 'bottom-wash' PC board cleaning methods.

SWITCH FUNCTION	ACTUATOR OR PLUNGER	BUSHING	TERMINATIONS	CONTACT MATERIAL	SEAL	CAP COLOR	FRAME COLOR	LED COLOR
				Gold	Epoxy	Black	Black	Red
[ ] [ ] [ ]	[ ] [ ] [ ]	[ ] [ ]	[ ] [ ] [ ] [ ] [ ]	[ ]	[ ]	[ ]	[ ]	[ ]
8121	J80	(NONE)	A	V21	B	(NONE)	(NONE)	(NONE)
8125	J81	D	A2	V31	G	1	1	3
8221	J82	D2	A3	V41	K	2	2	5
8225	J83	D3	A4	V61	L	3	3	6
8321	J84	D8	A6	V71		4	4	
8325	J85	D9	AV1	V81		5	5	
8421	J95	H	AV2	V91		6	6	
8425	L	H9	AV3	W		7	7	
U811	M	Y	AV4	W1		8	8	
U821	S	Y3	AW	W3		9	9	
U831		Y4	AW1	W4				
U841		Y9	AW3	Z				
			AW4	Z3				
			C					
			R					
			R2					
			V2					
			V3					
			V4					
			V6					
			V7					
			V8					
			V9					

D



8020 Series

# Snap-Acting Momentary Pushbutton Switches

## SWITCHES WITH STANDARD OPTIONS

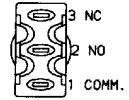
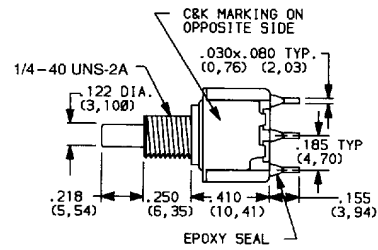
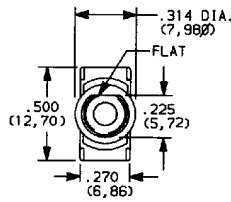
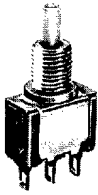

TERM. NOS. FOR REFERENCE ONLY

SPDT

Part No. Shown: 8121SHZGE

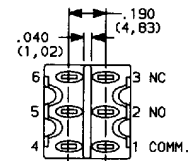
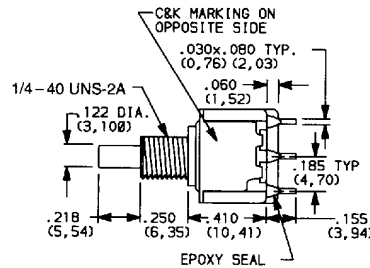
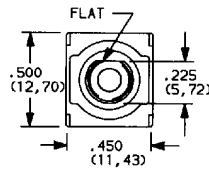
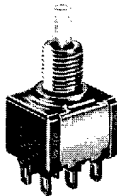

TERM. NOS. FOR REFERENCE ONLY

DPDT

Part No. Shown: 8221SHZGE

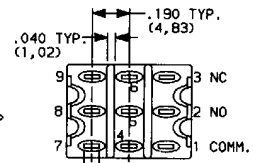
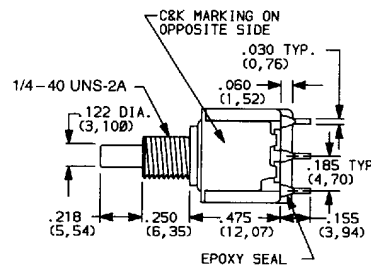
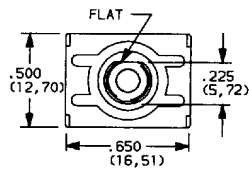
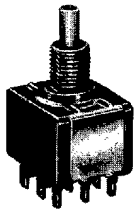

TERM. NOS. FOR REFERENCE ONLY

3PDT

Part No. Shown: 8321SHZGE

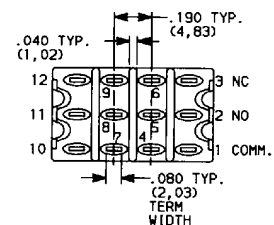
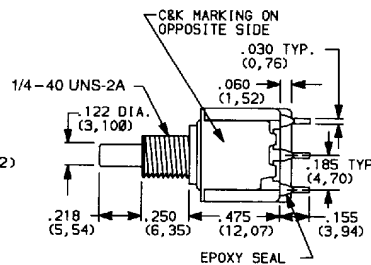
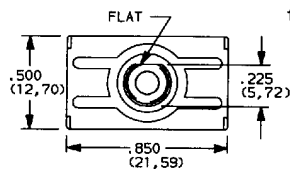
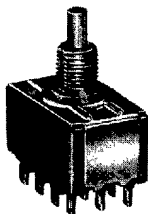

TERM. NOS. FOR REFERENCE ONLY

4PDT

Part No. Shown: 8421SHZGE

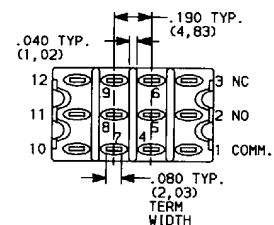
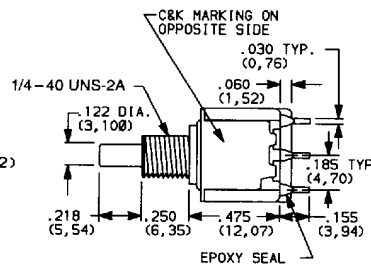
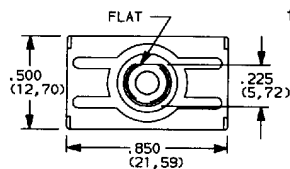
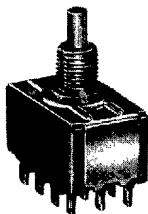

TERM. NOS. FOR REFERENCE ONLY

C&K COMPONENTS, INC.

57 Stanley Avenue, Watertown, MA 02172-4802

Tel: (617) 926-6400, Fax: (617) 926-6846

D-32

D 94E 1760885 0004195 138

## SWITCH FUNCTION

NO. POLES	MODEL NO.	UL / CSA MODEL NO.*	SWITCH FUNCTION		CONNECTED TERMINALS		SCHEMATIC
			POS. 1	POS. 2	POS. 1	POS. 2	
SP	8121	U811	ON	MOM.	1-3	1-2	
	8125		ON	MOM.			
DP	8221	U821	ON	MOM.	1-3,4-6	1-2,4-5	
	8225		ON	MOM.			
3P	8321	U831	ON	MOM.	1-3,4-6,7-9	1-2,4-5,7-8	
	8325		ON	MOM.			
4P	8421	U841	ON	MOM.	1-3,4-6,7-9,10-12	1-2,4-5,7-8,10-11	
	8425		ON	MOM.			

MOM = MOMENTARY

\* U811 thru U841 model numbers with all options (except R, R2 terminations) when ordered with G or L contact material. See AGENCY APPROVALS, page VIII. 8X25 models must be ordered with B or K contact material. 8X21 and U8X1 models must be ordered with G or L contact material.

## ACTUATORS—SNAP-IN FRONT MOUNT

### J80

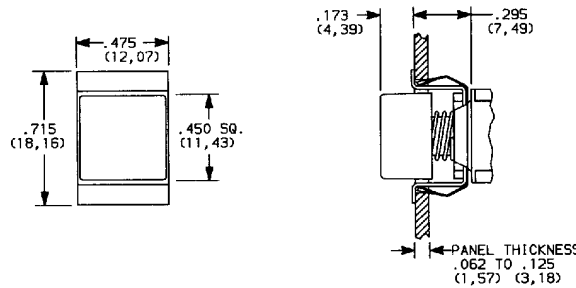
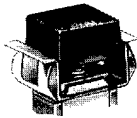

No frame color choice required.

### J81 WITH FRAME AND RAISED CAP

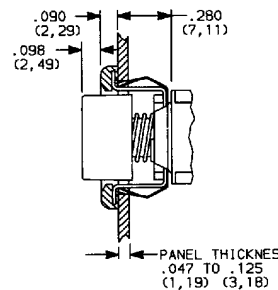
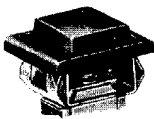

### J83 WITH FRAME AND FLUSH CAP

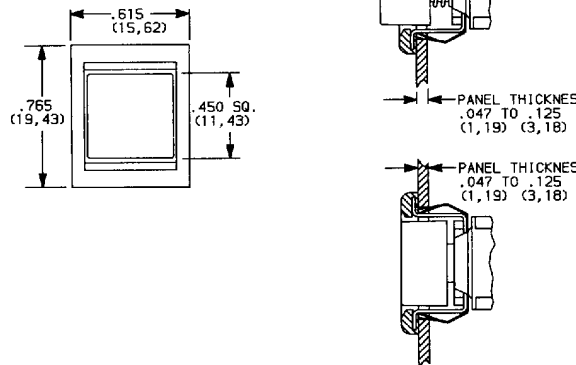

## CAP AND FRAME COLORS

OPTION CODE	CAP AND FRAME COLORS
1	WHITE
2	BLACK (std.)
3	RED
4	ORANGE
5	YELLOW
6	GREEN
7	BLUE
8	BROWN
9	GRAY

Select cap and frame colors (where applicable) from chart. Place option code(s) in appropriate box(es) of ordering format. Cap and frame finish: matte. Custom actuator markings and legends available, consult factory. Hardware is available separately, see catalog section H.

Available with Z, C, Z3, or W-W4 terminations and SPDT and DPDT models only.

### PANEL MOUNTING J80 - J81 - J83

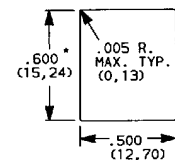

\* Increase this dim. to .620/.625 (15,75/15,88) for .091/.125 (2,31/3,18) thk. panels.

D

## ACTUATORS—SNAP-IN FRONT MOUNT

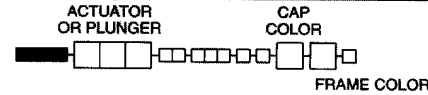

**J82** WITH FRAME FOR LED AND RAISED CAP

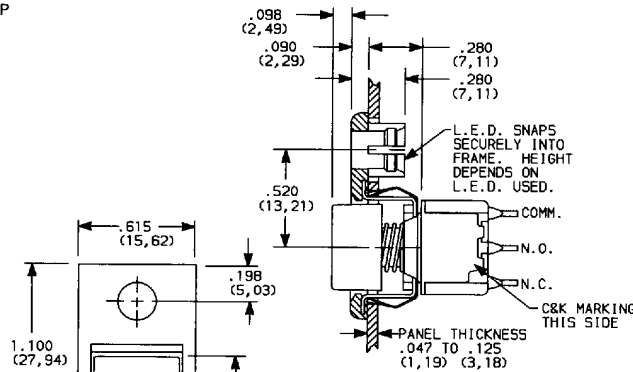
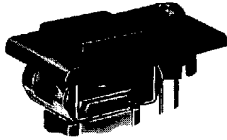

**J84** WITH FRAME FOR LED AND FLUSH CAP

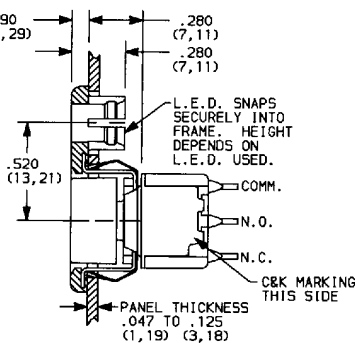
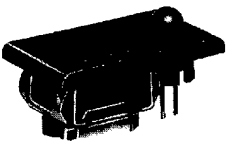

### CAP AND FRAME COLORS

OPTION CODE	CAP AND FRAME COLORS
1	WHITE
2	BLACK (std.)
3	RED
4	ORANGE
5	YELLOW
6	GREEN
7	BLUE
8	BROWN
9	GRAY

Select cap and frame colors from chart. Place option codes in appropriate boxes of ordering format. Cap and frame finish: matte. Custom actuator markings and legends available, consult factory. Caps and frames are available separately, see catalog section H.

Available with Z, C, Z3, or W-W4 terminations and SPDT and DPDT models only.

### PANEL MOUNTING J82 - J84

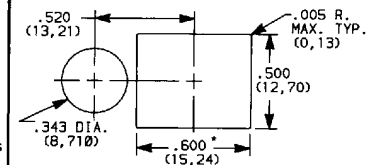

\* Increase this dim. to .620/.625 (15,75/15,88) for .091/.125 (2,31/3,18) thk. panels.

U.S. Patent No. 4,004,120  
LED not included.  
See page IX for LED information.

## ACTUATORS—SNAP-IN FRONT MOUNT

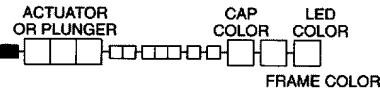

**J85** WITH FRAME, RAISED CAP, AND BUILT-IN LED

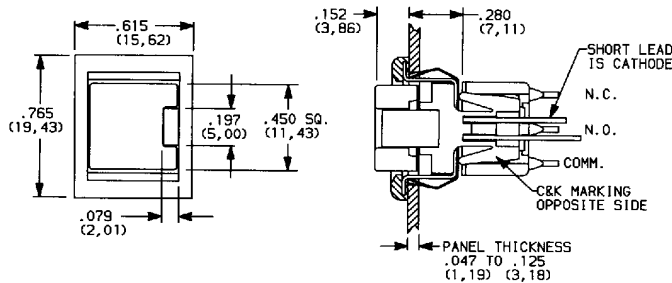
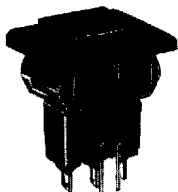

### PANEL MOUNTING

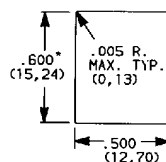

\* Increase this dim. to .620/.625 (15,75/15,88) for .091/.125 (2,31/3,18) thk. panels.

### CAP AND FRAME COLORS

OPTION CODE	CAP AND FRAME COLORS
1	WHITE
2	BLACK (std.)
3	RED
4	ORANGE
5	YELLOW
6	GREEN
7	BLUE
8	BROWN
9	GRAY

### LED COLOR

OPTION CODE	LED COLOR
3	RED (std.)
5	YELLOW
6	GREEN

Select cap, frame, and LED colors from charts. Place option codes in appropriate boxes of ordering format. Cap and frame finish: matte. Custom actuator markings and legends available, consult factory. Caps and frames are available separately, see catalog section H.

Available with Z, C, Z3, or W-W4 terminations and SPDT models only.

See page IX for LED information.

## ACTUATORS—P.C. MOUNT

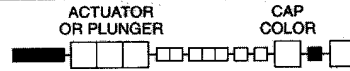

LED COLOR

J95 WITH BUILT-IN LED

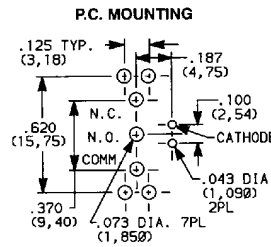
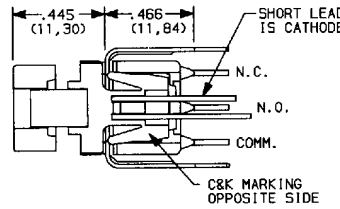
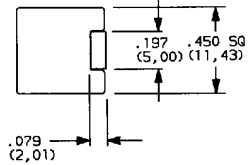

### CAP COLOR

OPTION CODE	CAP COLOR
1	WHITE
2	BLACK (std.)
3	RED
4	ORANGE
5	YELLOW
6	GREEN
7	BLUE
8	BROWN
9	GRAY

### LED COLOR

OPTION CODE	LED COLOR
3	RED (std.)
5	YELLOW
6	GREEN

Select cap and LED colors from charts. Place option codes in appropriate boxes of ordering format. Cap and frame finish: matte. Custom actuator markings and legends available, consult factory. Caps and frames are available separately, see catalog section H.

Available with V3 terminations and SPDT models only.

See page IX for LED information.

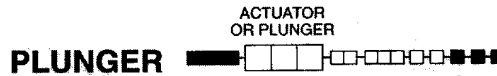

When selecting plunger option, bushing selection must also be made, see next page. No plunger option choice required when any JXX actuator option is selected.

(NONE) NO PLUNGER CHOICE REQUIRED WHEN ANY JXX ACTUATOR OPTION IS SELECTED.

S (STD.)

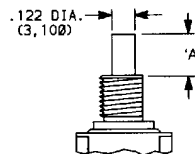

AVAILABLE BUSHINGS see next page	DIM 'A' FOR Z,C,Z3,W-W4 TERMINATIONS	DIM 'A' FOR A,A2,A3,A4,A6, AV1-AV4,AW-AW4,R,R2 TERMINATIONS	DIM 'A' FOR V2-V91 TERMINATIONS
D, D9	.244 (6,20)	.228 (5,79)	.224 (5,69)
H, H9	.218 (5,54)	.202 (5,13)	.198 (5,03)
Y, Y9	.203 (5,16)	.187 (4,75)	.183 (4,65)
Y3	(5,54)	(5,13)	(5,03)
Y4	.185 (4,70)	.169 (4,29)	.165 (4,19)
D2, D8	N/A	.232 (5,89)	.228 (5,79)
D3	.178 (4,52)	.162 (4,11)	.158 (4,01)

L

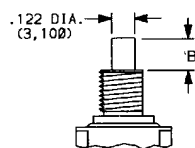

AVAILABLE BUSHINGS see next page	DIM 'B' FOR Z,C,Z3,W-W4 TERMINATIONS	DIM 'B' FOR A,A2,A3,A4,A6, AV1-AV4,AW-AW4,R,R2 TERMINATIONS	DIM 'B' FOR V2-V91 TERMINATIONS
Y, Y9	.178 (4,52)	.162 (4,11)	.158 (4,01)
Y4	.090 (2,29)	.074 (1,88)	.070 (1,78)

M SNAP-FITTING

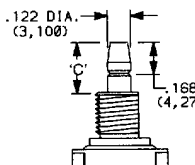

AVAILABLE BUSHINGS see next page	DIM 'C' FOR Z,C,Z3,W-W4 TERMINATIONS	DIM 'C' FOR A,A2,A3,A4,A6, AV1-AV4,AW-AW4,R,R2 TERMINATIONS	DIM 'C' FOR V2-V91 TERMINATIONS
D, D9	.297 (7,54)	.281 (7,14)	.277 (7,04)
H, H9	.267 (6,78)	.251 (6,38)	.247 (6,27)
Y, Y9	.259 (6,58)	.243 (6,17)	.239 (6,07)
Y3	(6,78)	(6,37)	(6,27)
Y4	.259 (6,58)	.243 (6,17)	.239 (6,07)
D2, D8	N/A	.273 (6,93)	.269 (6,83)
D3	.259 (6,58)	.243 (6,17)	.239 (6,07)

N/A = NOT AVAILABLE

Additional plunger lengths are available on SPDT and DPDT models, consult factory. Not all plunger lengths sufficient for use with caps. See cap dims., catalog section H.

## BUSHING

When selecting bushing option, plunger selection must also be made, see previous page. Plunger lengths vary with bushing and termination options selected. No bushing option choice required when any JXX actuator option is selected.

(NONE)

**D**  
D9 UNTHREADED

**H**  
H9 UNTHREADED

**Y**  
Y9 UNTHREADED

No bushing choice required when any JXX actuator option is selected.

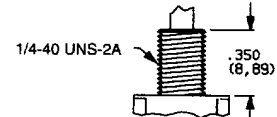
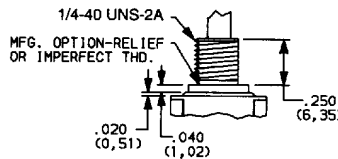
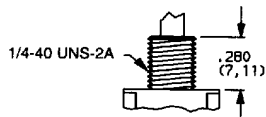
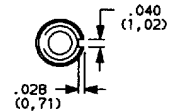
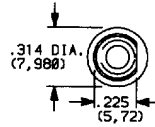
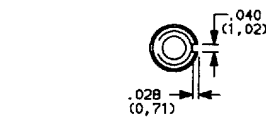

D9 bushing standard with A-A6, AW-AW4, R, R2 AV1-AV4 terminations.

H bushing standard with Z, C, Z3 or W-W4 terminations. H, H9 bushings not available on single pole models with A3-A6, AW-AW4, R, R2 terminations.

Will withstand 12 in.-lbs. of torque with no distortion.

**D**

**Y3** METRIC

**Y4**

**D2**

**D8** UNTHREADED

**D3**

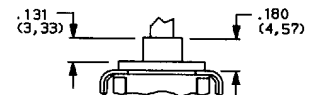
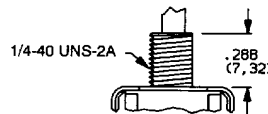
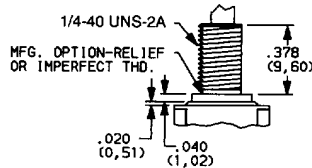
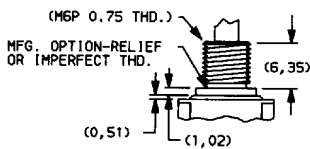
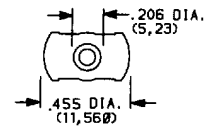
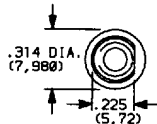
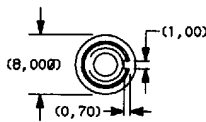

Y3, Y4 bushings not available on single pole models with A3-A6, AW-AW4, R, R2 terminations.

Will withstand 12 in.-lbs. of torque with no distortion.

D2, D8 bushings not available with Z, C, Z3, W-W4 terminations.

D3 bushing standard with V2-V91 terminations.

## PANEL MOUNTING

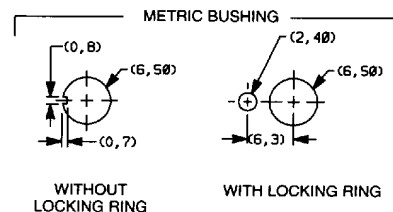
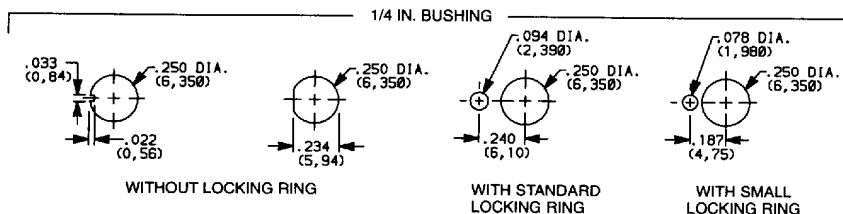

HARDWARE: Two mounting nuts, locking ring and lockwasher supplied standard with threaded bushings. Optional mounting nut and locking ring styles and finishes available, see HARDWARE, catalog section H.

## TERMINATIONS

Z (STD.)

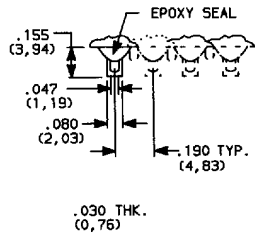

SPDT thru  
4PDT

Not available with J95 actuator, K or L contact materials.

C

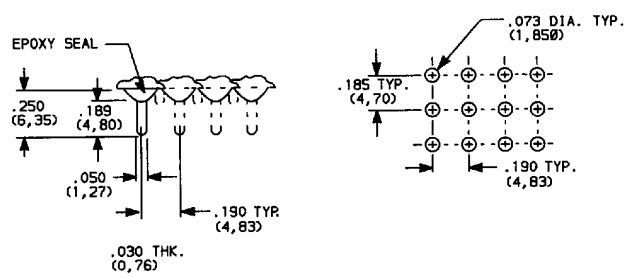

SPDT thru  
4PDT

Not available with J95 actuator option.

Z3 QUICK CONNECT

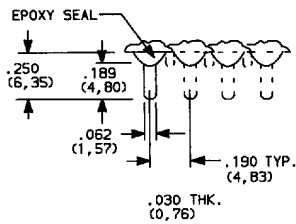

SPDT thru  
4PDT

Not available with J95 actuator, K or L contact materials.  
Mating quick connector available; order part no. 530100000.

W-W1-W3-W4 WIRE WRAP

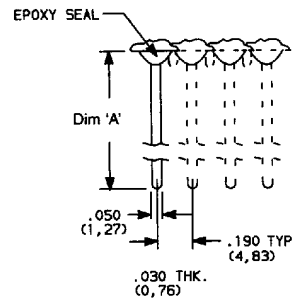

SPDT thru  
4PDT

Not available with J95 actuator option.

Option	Dim 'A'
W	.750 (19,05)
W1	.964 (24,49)
W3	.425 (10,80)
W4	1.062 (26,97)

D

A

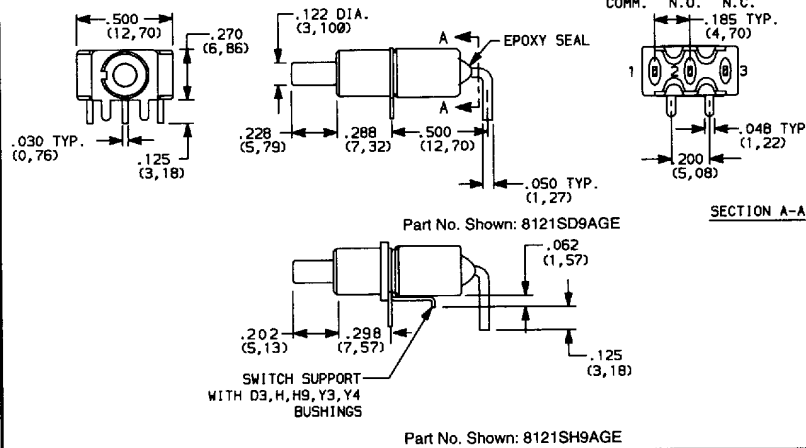

A

A3 SNAP-IN

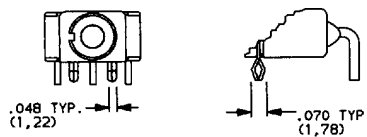

SPDT

Term. bend radii and lead-in mfg. option.  
Not available with JXX actuators,  
I seal option.

SNAP-IN DESIGN RETAINS SWITCH.

AW-AW1-AW3-AW4 EXTENDED

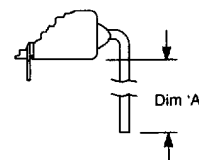

Option	Dim 'A'
AW	.50 (12,7)
AW1	.72 (18,3)
AW3	.20 (5,1)
AW4	.83 (21,1)

## TERMINATIONS

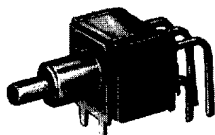
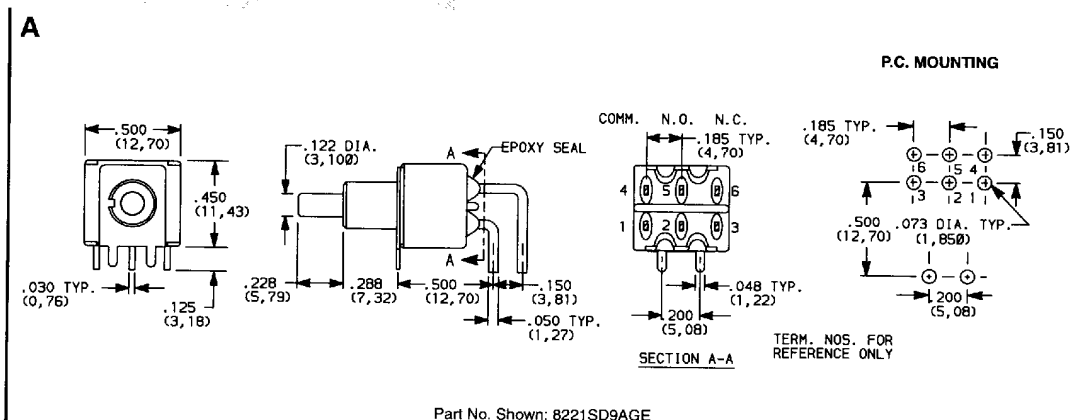

A

DPDT

Term. bend radii and lead-in mfg. option.  
Not available with JXX actuators,  
I seal option.

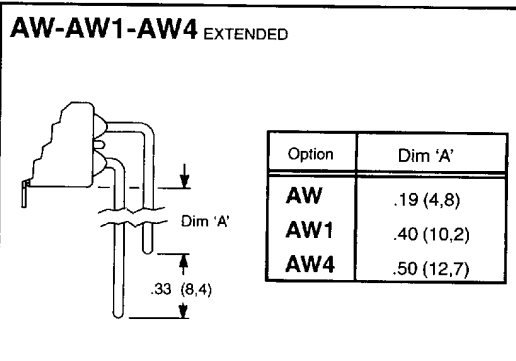
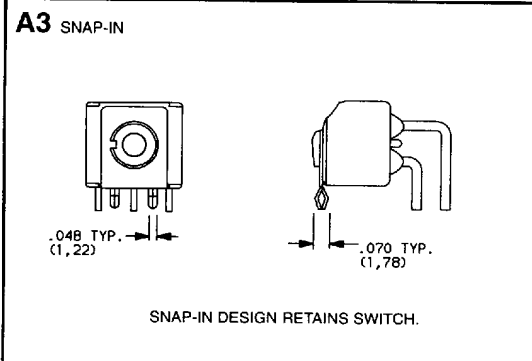

D

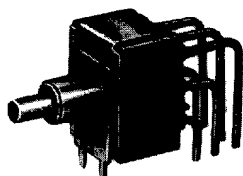
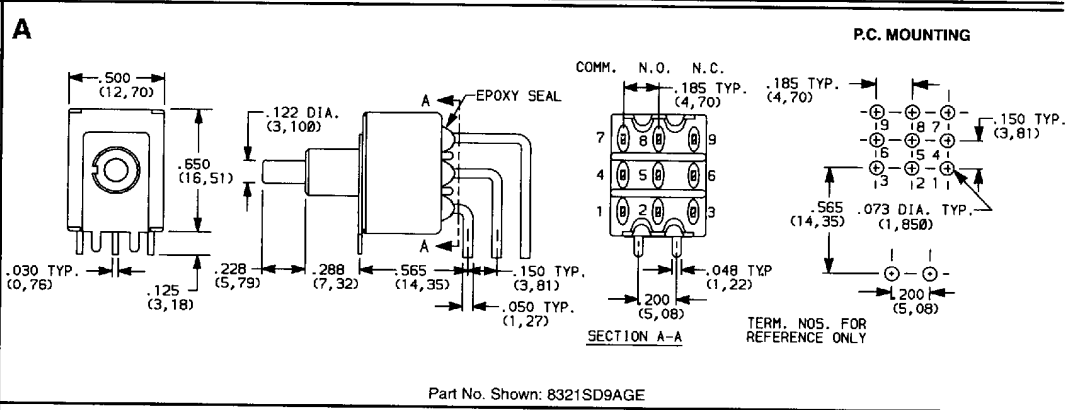

A

3PDT

Term. bend radii and lead-in mfg. option.  
Not available with JXX actuators,  
I seal option.

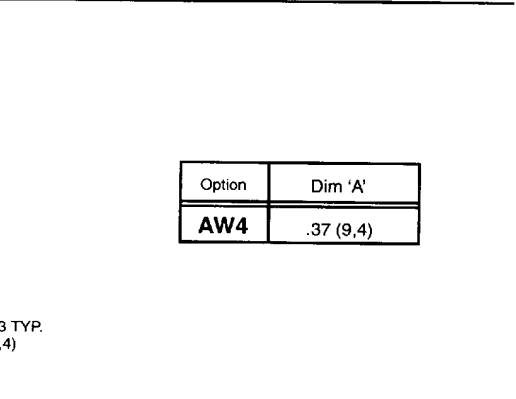
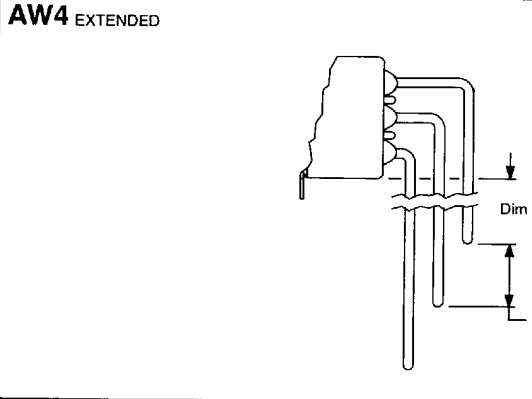



## TERMINATIONS

### A2

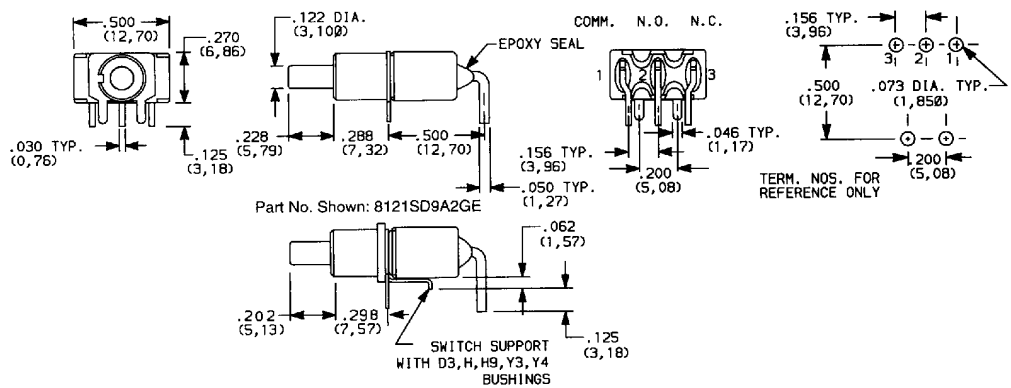

### SPDT

Term. bend radii and lead-in mfg. option. Not available with JXX actuators, I seal option.

### A4

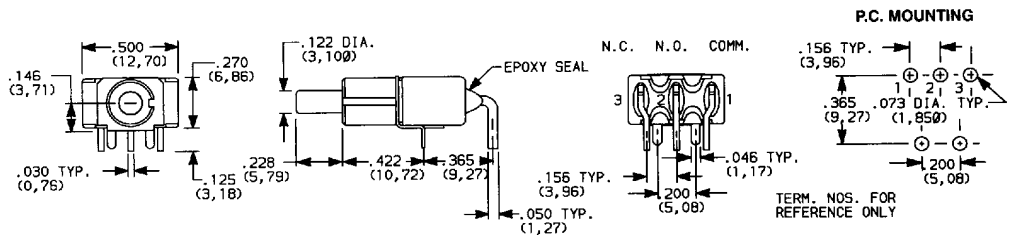
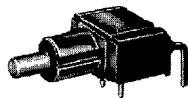

### SPDT

Term. bend radii and lead-in mfg. option. Not available with JXX actuators D3, H, H9, Y3, Y4 bushings, I seal option.

The A4 and R2 termination options are functionally identical and fit the same P.C. mounting pattern. The switches, however, are shifted relative to the mounting holes. Unlike the R2, the A4 option is available with UL and CSA. Note that the P.C. pattern must clear the switch support legs.

Part No. Shown: 8121SD9A4GE

### A6

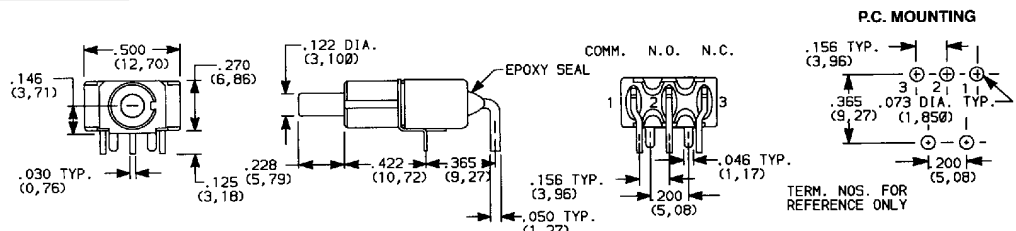
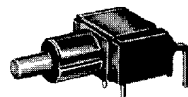

### SPDT

Term. bend radii and lead-in mfg. option. Not available with JXX actuators D3, H, H9, Y3, Y4 bushings, I seal option.

The A6 and R termination options are functionally identical and fit the same P.C. mounting pattern. The switches, however, are shifted relative to the mounting holes. Unlike the R, the A6 option is available with UL and CSA. Note that the P.C. pattern must clear the switch support legs.

Part No. Shown: 8121SD9A6GE

### R

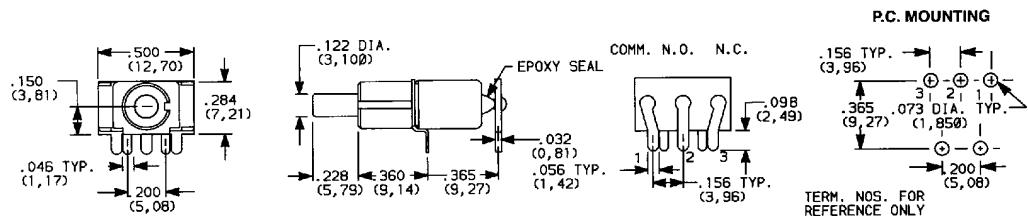
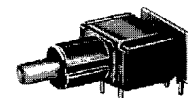

### SPDT

Not available with JXX actuators, D3, H, H9, Y3, Y4 bushings, I seal option. R terminations not UL, CSA approved.

### R2

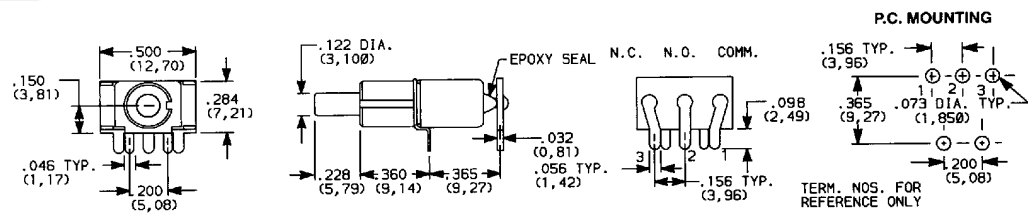
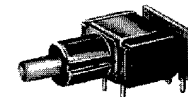

### SPDT

Not available with JXX actuators, D3, H, H9, Y3, Y4 bushings, I seal option. R2 terminations not UL, CSA approved.

D



8020 Series

# Snap-Acting Momentary Pushbutton Switches

## TERMINATIONS

AV2

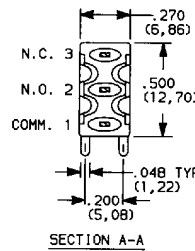
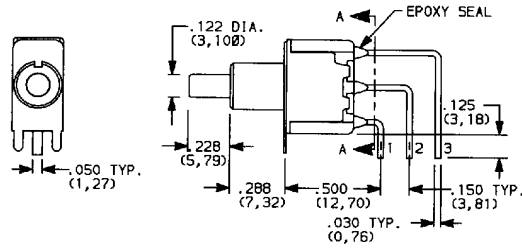

P.C. MOUNTING

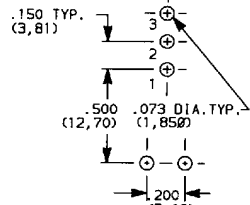

TERM. NOS. FOR REFERENCE ONLY

Part No. Shown: 8121SD9AV2GE

AV3 SNAP-IN

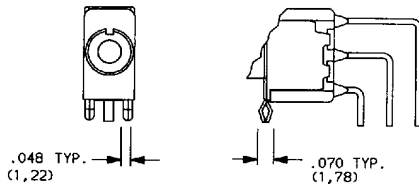

SNAP-IN DESIGN RETAINS SWITCH.

AV1-AV4 EXTENDED

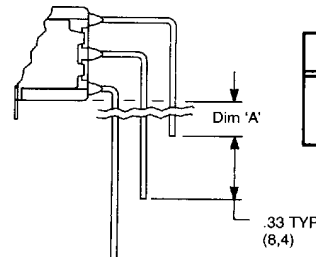

Option	Dim 'A'
AV1	.15 (3,8)
AV4	.24 (6,1)

AV2

SPDT

Term. bend radii and lead-in mfg. option. Not available with JXX actuators, I seal option.

AV2

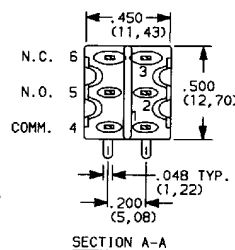
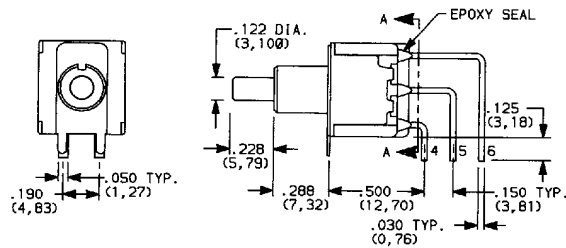

P.C. MOUNTING

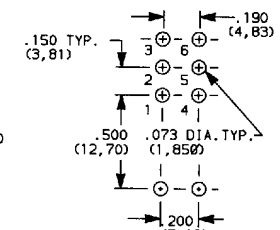

TERM. NOS. FOR REFERENCE ONLY

Part No. Shown: 8221SD9AV2GE

AV3 SNAP-IN

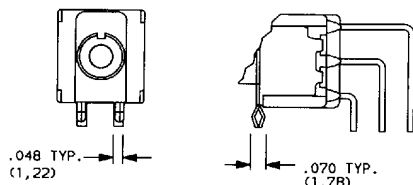

SNAP-IN DESIGN RETAINS SWITCH.

AV1-AV4 EXTENDED

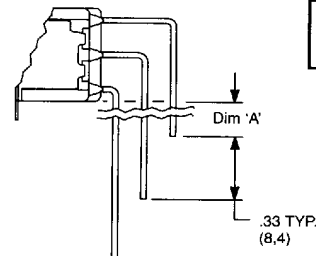

Option	Dim 'A'
AV1	.15 (3,8)
AV4	.24 (6,1)

AV2

DPDT

Term. bend radii and lead-in mfg. option. Not available with JXX actuators, I seal option.

**C&K** COMPONENTS, INC.

57 Stanley Avenue, Watertown, MA 02172-4802

Tel: (617) 926-6400, Fax: (617) 926-6846

D-40

D 94E ■ 1760885 0004203 034 ■

## TERMINATIONS

### AV2

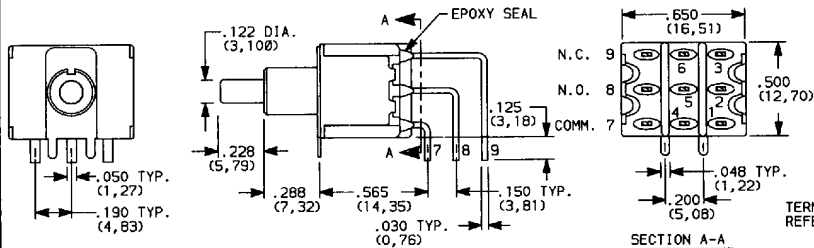

### P.C. MOUNTING

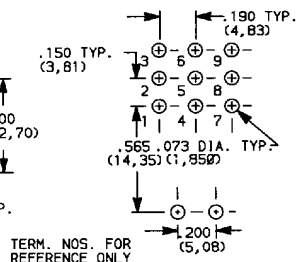

Part No. Shown: 8321SD9AV2GE

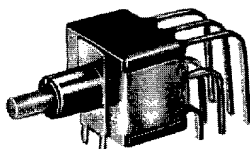

AV2

3PDT

Term. bend radii and lead-in mfg. option. Not available with JXX actuators I seal option.

### AV3 SNAP-IN

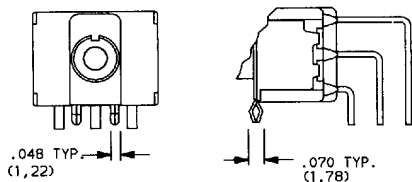

SNAP-IN DESIGN RETAINS SWITCH.

### AV1-AV4 EXTENDED

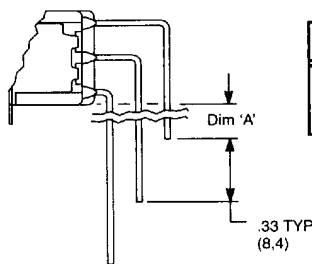

Option	Dim 'A'
AV1	.15 (3,8)
AV4	.24 (6,1)

### AV2

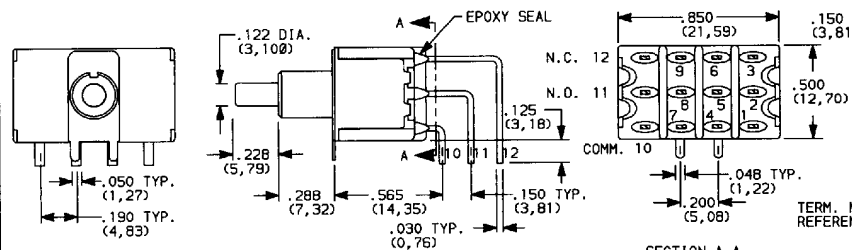

### P.C. MOUNTING

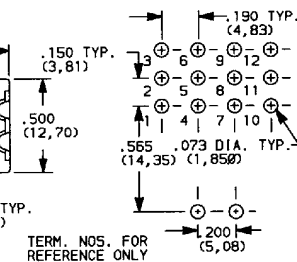

Part No. Shown: 8421SD9AV2GE

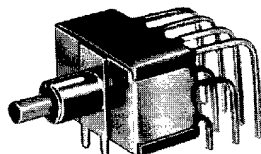

AV2

4PDT

Term. bend radii and lead-in mfg. option. Not available with JXX actuators I seal option.

### AV3 SNAP-IN

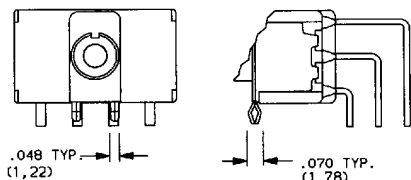

SNAP-IN DESIGN RETAINS SWITCH.

### AV1-AV4 EXTENDED

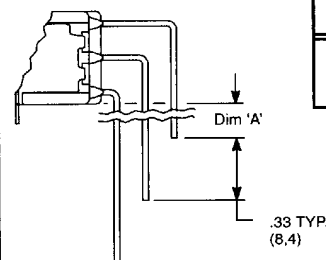

Option	Dim 'A'
AV1	.15 (3,8)
AV4	.24 (6,1)

## TERMINATIONS

**V3-V4-V9** REPLACES V30-V40-V90

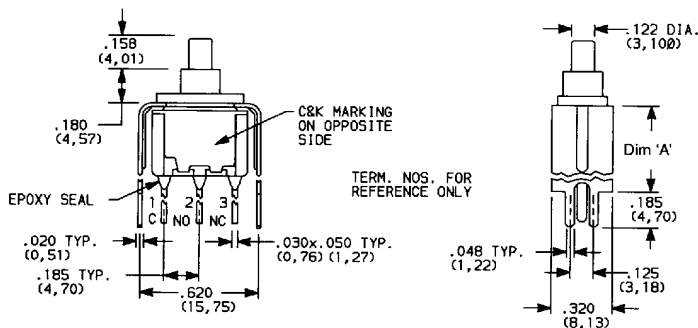

Part No. Shown: 8121SD3V\_\_GE

**V31-V41-V91** SNAP-IN

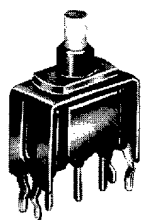

V31

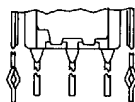

SNAP-IN DESIGN RETAINS SWITCH.

### P.C. MOUNTING

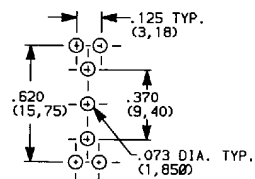

Option	Dim 'A'
V3, V31	.460 (11,68)
V4, V41	.630 (16,00)
V9, V91	1.150 (29,21)



V3

SPDT

Not available with J8X actuators, I seal option.

**V3-V4-V9** REPLACES V30-V40-V90

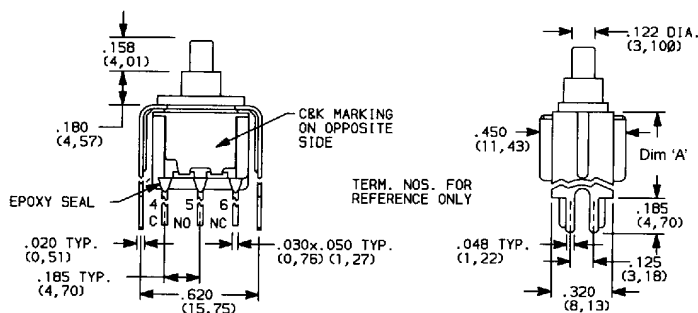

Part No. Shown: 8221SD3V\_\_GE

**V31-V41-V91** SNAP-IN

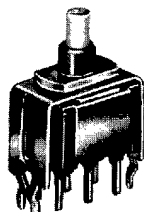

V31

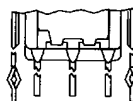

SNAP-IN DESIGN RETAINS SWITCH.

### P.C. MOUNTING

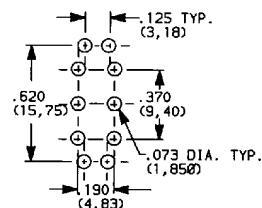

Option	Dim 'A'
V3, V31	.460 (11,68)
V4, V41	.630 (16,00)
V9, V91	1.150 (29,21)



V3

DPDT

Not available with JXX actuators, I seal option.

## TERMINATIONS

### V4-V9

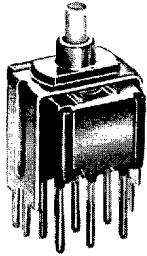
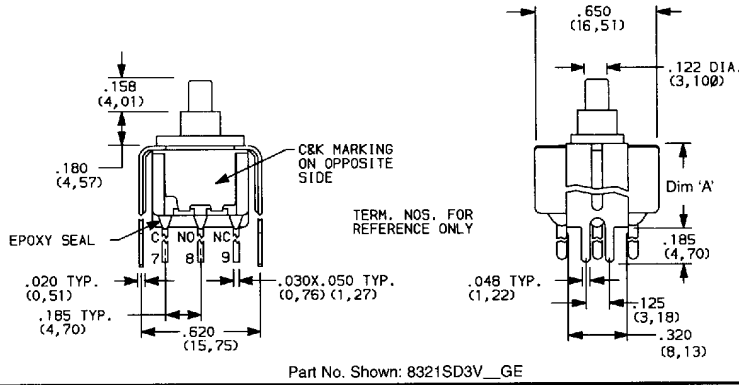

V4

### V41-V91 SNAP-IN

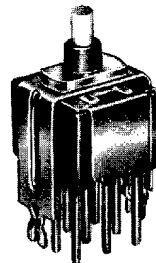

V41

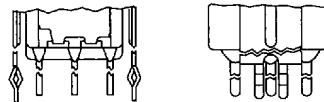

SNAP-IN DESIGN RETAINS SWITCH.

### P.C. MOUNTING

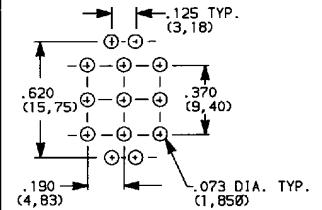

Option	Dim 'A'
V4, V41	.630 (16,00)
V9, V91	1.150 (29,21)

### 3PDT

Not available with JXX actuators, I seal option.

### V4-V9

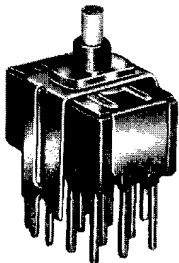
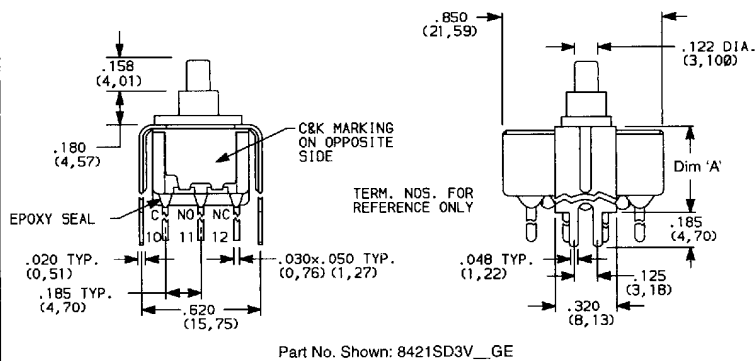

V4

### V41-V91 SNAP-IN

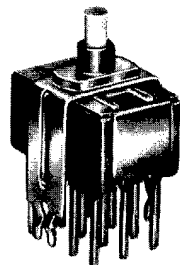

V41



SNAP-IN DESIGN RETAINS SWITCH.

### P.C. MOUNTING

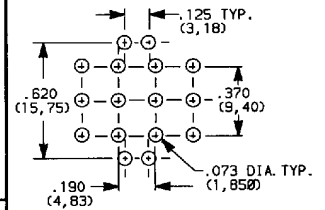

Option	Dim 'A'
V4, V41	.630 (16,00)
V9, V91	1.150 (29,21)

### 4PDT

Not available with JXX actuators, I seal option.

### TERMINATIONS

**V2-V6-V7-V8** REPLACES V20-V60-V70-V80

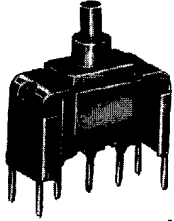
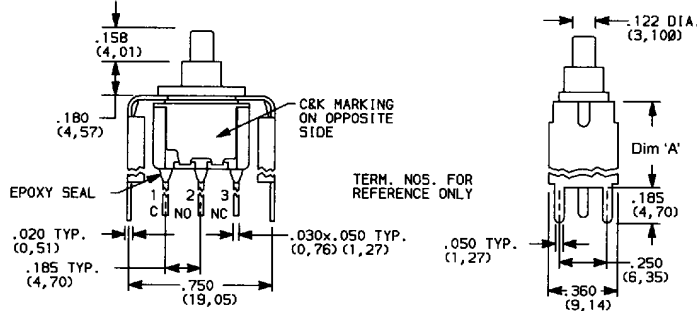

V6

**V21-V61-V71-V81** SNAP-IN

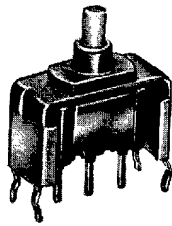

V61

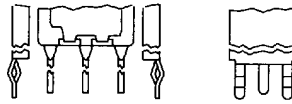

SNAP-IN DESIGN RETAINS SWITCH.

#### P.C. MOUNTING

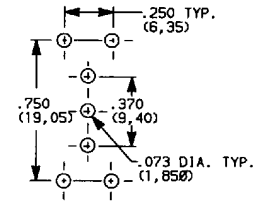

Option	Dim 'A'
V2, V21	.555 (14,10)
V6, V61	.460 (11,68)
V7, V71	.630 (16,00)
V8, V81	.953 (24,21)

SPDT

Not available with JXX actuators, I seal option.

**V2-V6-V7-V8** REPLACES V20-V60-V70-V80

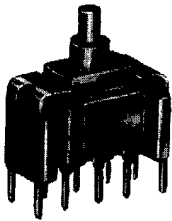
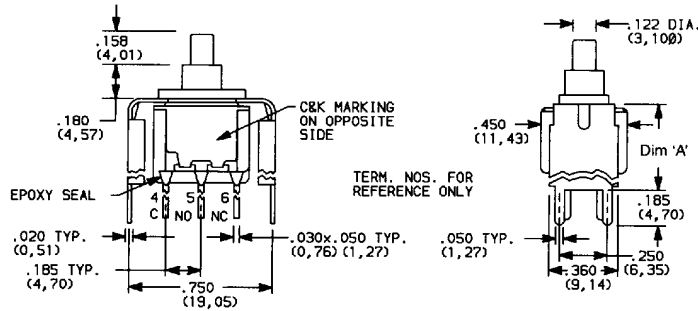

V6

**V21-V61-V71-V81** SNAP-IN

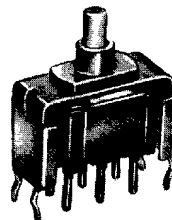

V61

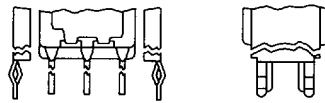

SNAP-IN DESIGN RETAINS SWITCH.

#### P.C. MOUNTING

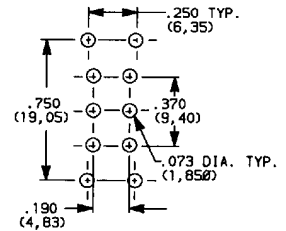

Option	Dim 'A'
V2, V21	.555 (14,10)
V6, V61	.460 (11,68)
V7, V71	.630 (16,00)
V8, V81	.953 (24,21)

DPDT

Not available with JXX actuators, I seal option.

## TERMINATIONS

### V2-V7-V8

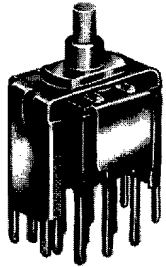

V7

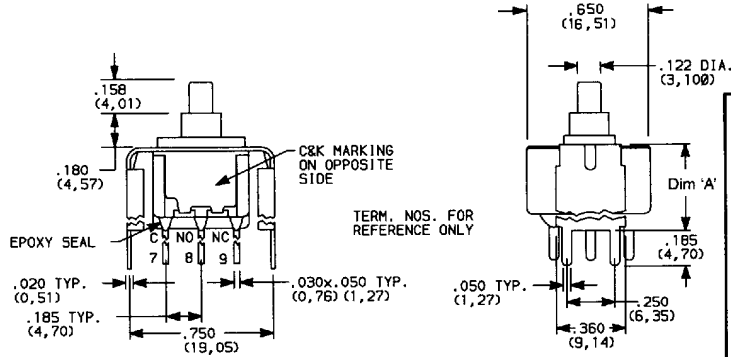

Part No. Shown: 8321SD3V\_\_GE

### V21-V71-V81 SNAP-IN

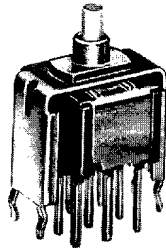

V71

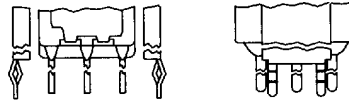

SNAP-IN DESIGN RETAINS SWITCH.

### P.C. MOUNTING

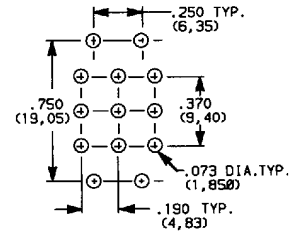

Option	Dim 'A'
V2, V21	.555 (14,10)
V7, V71	.630 (16,00)
V8, V81	.953 (24,21)

### 3PDT

Not available with JXX actuators, I seal option.

### V2-V7-V8

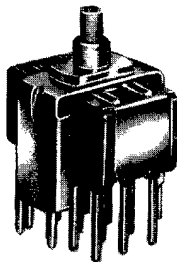

V7

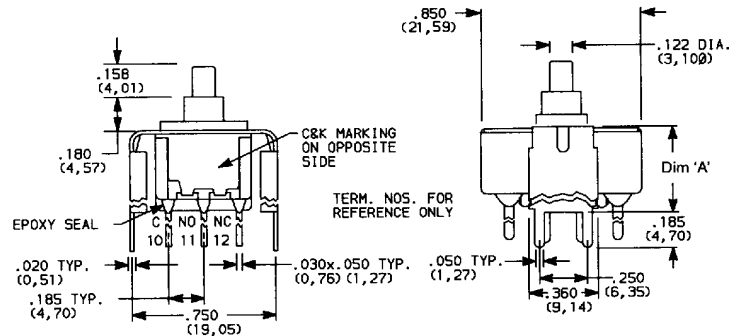

Part No. Shown: 8421SD3V\_\_GE

### V21-V71-V81 SNAP-IN

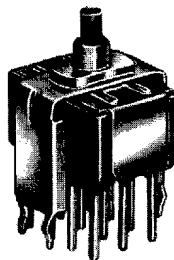

V71

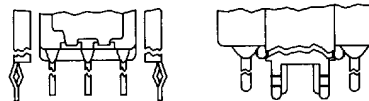

SNAP-IN DESIGN RETAINS SWITCH.

### P.C. MOUNTING

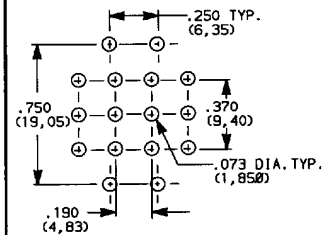

Option	Dim 'A'
V2, V21	.555 (14,10)
V7, V71	.630 (16,00)
V8, V81	.953 (24,21)

### 4PDT

Not available with JXX actuators, I seal option.

### CONTACT MATERIAL

OPTION CODE	CONTACT MATERIAL	TERMINAL PLATING	RATINGS	
B	GOLD <sup>1</sup>	GOLD <sup>1</sup>	LOW LEVEL / DRY CIRCUIT	8X25 MODELS ONLY: 0.4 VA MAX. @ 20 V AC OR DC MAX.
K		TIN-LEAD <sup>4</sup>		
G	GOLD OVER SILVER <sup>2,3</sup>	GOLD <sup>3</sup>	LOW LEVEL / DRY CIRCUIT OR POWER	8X21, U8X1 MODELS ONLY: 0.4 VA MAX @ 20 V AC OR DC MAX. OR 1 AMP @ 120 V AC OR 28 V DC;
L		TIN-LEAD <sup>4</sup>		

CONTACT MATERIAL / APPLICATION RECOMMENDATIONS—SEE CHART, PAGE X.

<sup>1</sup> ALL CONTACTS & TERMINALS: Copper alloy, with gold plate over nickel plate.

<sup>2</sup> N.O. & N.C. CONTACTS: Coin silver, with gold plate over nickel plate.

<sup>3</sup> COMMON CONTACTS & ALL TERMINALS: Copper alloy, with gold plate over nickel plate.

<sup>4</sup> TERMINALS: Copper alloy, with tin-lead alloy over nickel plate.

B or K contact material must be ordered with 8X25 models.  
G or L contact material must be ordered with 8X21, U8X1 models.  
K and L contact materials not available with Z, Z3 terminations.

U811-U841 model numbers  with all options (except R, R2 terminations) when ordered with mandatory G or L contact material. See pages D-33 and VIII.

### SEAL

E (STD.)

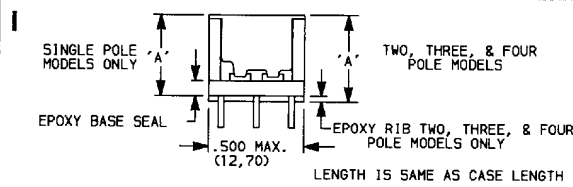
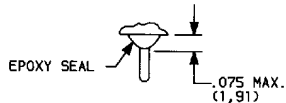

Poles	Dim 'A'
SP	.410 (10,41)
DP	.440 (11,18)
3P	.505 (12,83)
4P	.505 (12,83)

Available with Z, C, Z3, W-W4 terminations only.

### HOW TO ORDER

All available 8020 SERIES SNAP-ACTING MOMENTARY PUSHBUTTON SWITCH options are listed on page D-31, and are described on pages D-33 thru D-46. Switches with standard options are shown on page D-32. When selecting options and building a part number, some ordering format boxes may not be filled. Dashes, hyphens or spaces in the part number are not significant, and are shown for clarity only.

All models have epoxy terminal seal and are compatible with 'bottom wash' PC board cleaning methods.  models available, see page D-33. Actuator caps, hardware and accessories are available separately, see catalog section H.

### SPECIFICATIONS

#### CONTACT RATING:

8X21, U8X1 MODELS: 1 AMP @ 120 V AC or 28 V DC or 0.4 VA max. @ 20 V AC or DC max. (G contact material).

8X25 MODELS: 0.4 VA max. @ 20 V AC or DC maximum (B contact material).

NOTE: Break-before-make contacts. Multi-pole contact do not make and break simultaneously.

ELECTRICAL LIFE: 60,000 make-and-break cycles at full load.

CONTACT RESISTANCE: Below 50 milliohms typ. initial @ 2-4 V DC, 100 mA, for both silver and gold plated contacts.

INSULATION RESISTANCE: 10<sup>9</sup> ohms min.

DIELECTRIC STRENGTH: 1,000 V RMS min. @ sea level.

OPERATING TEMPERATURE: 8X2X MODELS: -30°C to 75°C.  
U8X1 MODELS: -30°C to 65°C.

CAP INSTALLATION FORCE: 10 lbs. max. permissible.

SOLDERABILITY: Per MIL-STD-202F method 208D, or EIA RS-186E method 9 (1 hour steam aging).

### MATERIALS

CASE: Glass filled nylon 6/6, flame retardant, heat stabilized, or diallyl phthalate (DAP) (UL 94V-0).

PLUNGER: Glass filled nylon or glass filled polyester (UL 94V-0).

CAP & FRAME: Nylon, black, standard.

BUSHING: Brass or zinc, nickel plated.

HOUSING: Stainless steel.

SWITCH SUPPORT: Brass or steel, tin plated.

#### N.O. & N.C. CONTACTS

8X21, U8X1 MODELS: Coin silver, with gold plate over nickel plate (G contact material).

8X25 MODELS: Copper alloy, with gold plate over nickel plate (B contact material).

COMMON CONTACT & ALL TERMINALS: Copper alloy, with gold plate over nickel plate.

TERMINAL SEAL: Epoxy.

HARDWARE: Nut & Locking ring—Brass, nickel plated;  
Lockwasher—Steel, nickel plated.

NOTE: Specifications and materials listed above are general specifications. Specifications available for specific and custom switches, consult factory.



## X-ON Electronics

Largest Supplier of Electrical and Electronic Components

*Click to view similar products for [Pushbutton Switches](#) category:*

*Click to view products by [C&K](#) manufacturer:*

Other Similar products are found below :

[LW1L-M1C10V-A](#) [LW2L-A1C20M-GD](#) [LW2L-M1C20M-A](#) [60324L](#) [M7E-HRN2](#) [67021K512](#) [67081K512X](#) [701PB580](#) [719-5504-000](#)  
[MDPSSGLFS](#) [810KSV30B](#) [FLT 2U EE 01A](#) [MML21KA3ABK](#) [MML23KA3AC05K-001](#) [MML23KW3AA01W](#) [8418K2](#) [8646AB6X718UL](#)  
[8646ABUL](#) [FSDWH](#) [9001KXRK](#) [9001T8BK](#) [9533CD4+U574+U4922](#) [1203MRA](#) [A22EM01S](#) [A595](#) [1202A6](#) [12037A2ULCSA](#) [1203A2UL](#)  
[ABD122N-B](#) [1211390004](#) [ABN111-Y](#) [ABN400-R](#) [1211500044](#) [1211580012](#) [1212MRA](#) [1232A6NF](#) [RA3CSH6A](#) [1241.1183.7047](#)  
[1241.2511](#) [1241.3428](#) [1223A2ULCSA](#) [1223MRA](#) [1232AX2119](#) [1241.1183.8000](#) [1241.1183.8029](#) [1241.2506](#) [1241.2606](#) [12MA6](#)  
[1301940184](#) [RELBARF6X10\(PLASTIC\)](#)