



AP Series Industrial Pushbutton Switch

Pushbutton A

Features/Benefits

- IP67 sealed
- 1,000,000 life cycle
- Illumination / non-illumination
- Multiple colored caps
- Threaded or snap-in mounting
- Caps available separately
- RoHS compliant

Typical Applications

- Harsh environments
- Off-Road
- Industrial
- Medical
- Transportation
- Joystick control modules
- Gaming
- Military



Specifications

FUNCTION: SPST Momentary
 CONTACT ARRANGEMENT: N.O.
 MOUNTING TYPE:
 Snap-in (no panel seal)
 Threaded body (hex nut, lock washer, and panel seal gasket provided)
 Torque spec for threaded body: Do not exceed 8-9 in-lbs (0.9-1.0 N.m)

Mechanical

OPERATING LIFE: 1,000,000 cycles
 TOTAL TRAVEL: 2.1 ± 0.2 mm
 OPERATING POINT 1.55 ± 0.25 mm
 OVER TRAVEL: 0.6 min.
 OPERATING FORCE: 4N ± 1N standard configuration; other force option 2N ± 0.5N
 VIBRATION: 10-500 Hz 10g Max
 SHOCK: 60g 11ms sawtooth wave

Electrical

CONTACT RATING:
 200mA @ 24 V DC resistive (500,000 cycles)
 100mA @ 50 V DC resistive (500,000 cycles)
 400mA @ 32 V AC resistive (500,000 cycles)
 125mA @ 125 V AC resistive (1,000,000 cycles)
 DIELECTRIC STRENGTH: 1000 V AC min.
 INSULATION RESISTANCE: 1 G Ω @ 500 VDC
 INITIAL CONTACT RESISTANCE 50 mΩ max (without wire leads)
 BOUNCE TIME: <5 ms

Materials

HOUSING: PBT
 BASE: PBT
 CAP: PBT
 ACTUATOR:
 Illuminated: Clear polycarbonate
 Non-illuminated: PBT
 INTERNAL SEAL: Silicone rubber
 TERMINALS: Copper alloy, gold over silver plating
 MOVABLE CONTACT: Copper alloy, gold over silver plating
 TERMINAL SEAL: Epoxy
 WIRE LEADS: UL1569 Black 22 AWG

Operating Environment

OPERATING TEMPERATURE: -40°C to 85°C (+105°C non-illuminated)
 ESD PROTECTION: 20 KV min.

Process Environment

SEALING: IP67 for threaded body
 IP65 for snap-in version (no panel seal)

NOTE: Specifications and materials listed above are for switches with standard options. For information on specific and custom switches, please contact Customer Service.

Build-A-Switch

To order, simply select desired option from each category and place in the appropriate box.



Designation

AP AP Series

Operating Force

2 2 Newtons
4 4 Newtons

Actuator Style

D Dome / Convex
C Concave
E Extended Dome
N None

Actuator Color

0 No Cap
2 Black
3 Red
4 Orange
5 Yellow
6 Green
7 Blue
9 Gray

Illumination

00 No LED*
01 Super White
02 Bi-color; Red (Green)
03 Red
05 Amber
06 Green
07 Super Blue
08 Bi-color; Amber (Green)

Terminal Seal

E Epoxy
 All models are epoxy sealed

Contact Material

B Gold

Termination

Z Solder Lug
W 12" Wire Leads 22 AWG
C*** PC Terminals

Bushing Style**

S** Snap-in plastic
T Threaded plastic

** No panel seal option
 *** PC terminals not available with illumination

Contact Customer Service for additional hardware options.

Please contact Customer Service for additional colors and paint / laser etched button options.

* No LED available in short body only



Specifications and dimensions subject to change

AP Series Industrial Pushbutton Switch



A

Pushbutton

STANDARD VIEW

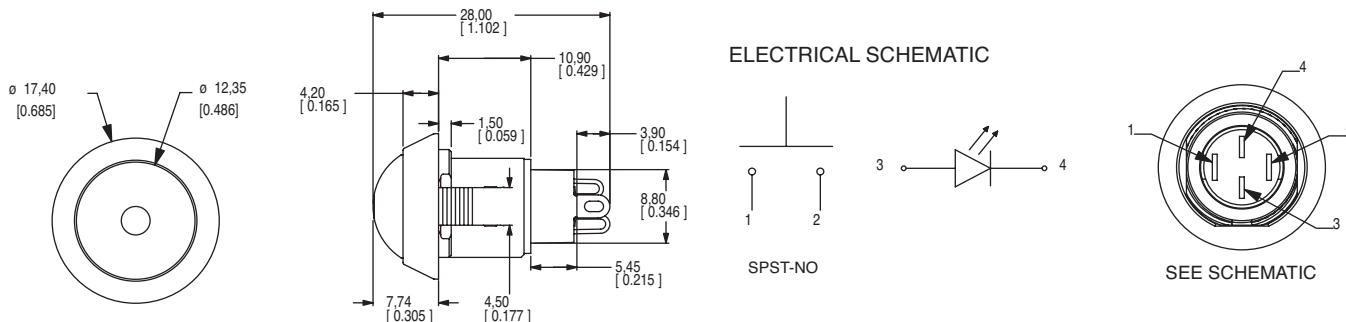

OPERATING FORCE

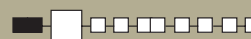

OPTION CODE	OPERATING FORCE
2	2 N, 200 g
4	4 N, 400 g

ACTUATOR STYLE

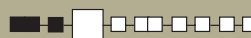

D DOME / CONVEX

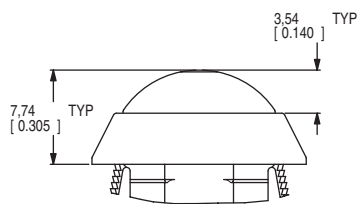

E EXTENDED DOME

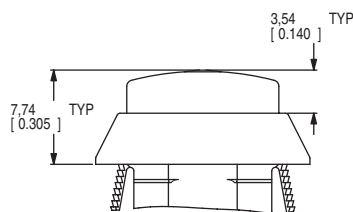

C CONCAVE

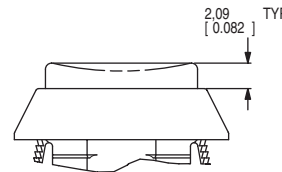
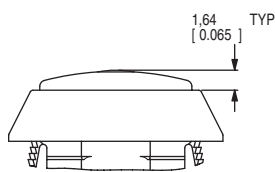
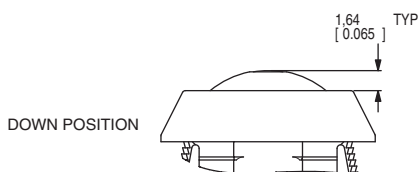
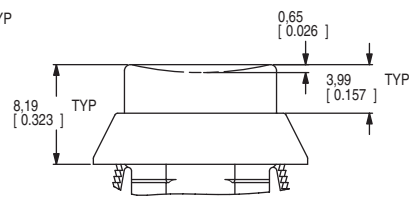

ACTUATOR COLOR



OPTION CODE	ACTUATOR COLOR
0	No Cap
2	Black
3	Red
4	Orange
5	Yellow
6	Green
7	Blue
9	Gray

For additional colors please contact Customer Service.

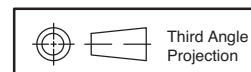

Dimensions are shown: mm (inches)
 Specifications and dimensions subject to change



AP Series Industrial Pushbutton Switch

Pushbutton

ILLUMINATION

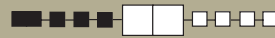

OPTION CODE	ILLUMINATION TYPE	TYPICAL INTENSITY*		PEAK WAVELENGTH	Vf Forward Voltage
		MIN	MAX		
		(mcd)		(nm)	
00	Model without illumination	N/A		N/A	
01	LED Super White	4,000	5,000	N/A	3.5
02	LED Bi-Color – Red (Green)	10	20	635/565	2.0
03	LED Red	4	8	700	2.0
05	LED Amber	35	50	610	2.0
06	LED Green	35	50	565	2.0
07	LED Super Blue	800	1,500	470	3.8
08	LED Bi-Color – Amber (Green)	10	10	585/565	2.0

*LED FORWARD CURRENT: 20 mA
 LED FORWARD VOLTAGE: see chart above
 LED REVERSE VOLTAGE: 5.0 V MAX

* For information on specific and custom LED, please contact Customer Service.

NOTE:

For bi-color LED's the polarity must be reversed to alternate the color

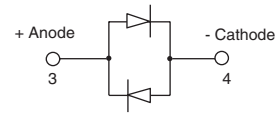

BUSHING STYLE



S SNAP-IN

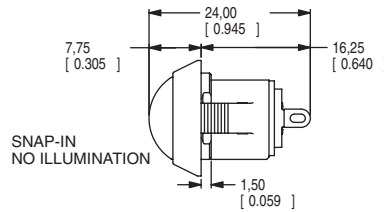
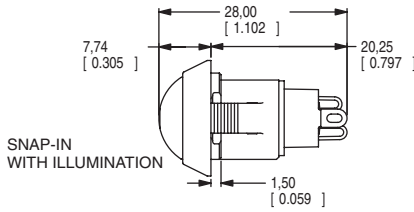

T THREADED PLASTIC

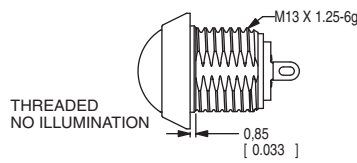
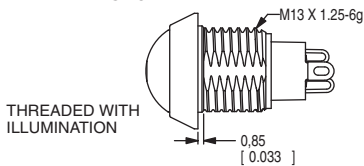

PANEL CUTOUT

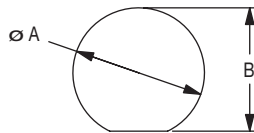

PANEL THICKNESS	DIM A (± 0.05 mm)	DIM B (± 0.05 mm)
1 mm [0.039 in]	13.70 mm [0.539 in]	13.00 mm [0.512 in]
2 mm [0.079 in]	13.80 mm [0.539 in]	13.00 mm [0.512 in]
3 mm [0.118 in]	13.90 mm [0.547 in]	13.10 mm [0.516 in]
THREADED BODY MIN PANEL THICKNESS 1 mm	13.70 mm [0.539 in]	13.00 mm [0.512 in]



A 0.1mm min. chamfer on the leading edge of the mounting hole is recommended for snap-in version.

are shown: mm (inches)
 sions subject to change

ckswitches.com



TERMINATION



Z SOLDER LUG

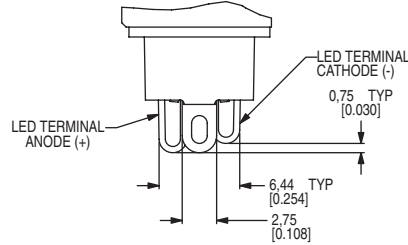
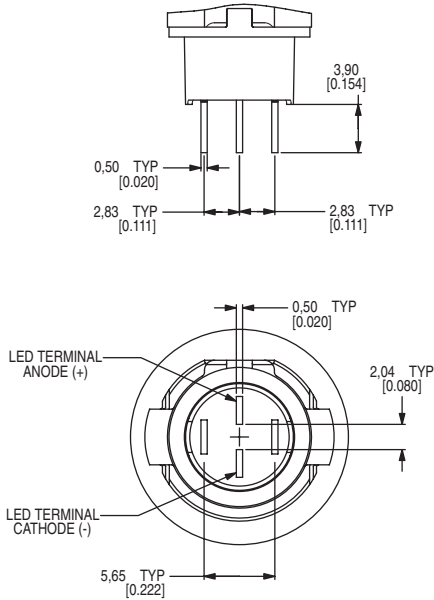

* Switching terminals are gold and LED terminals are silver

C PC TERMINALS

*** Illumination not available with PC Terminals

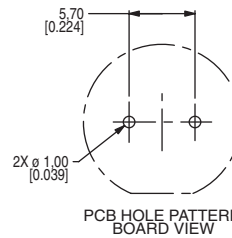
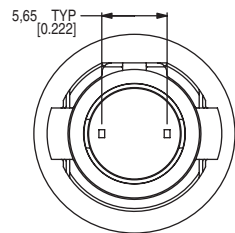
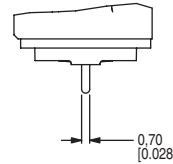
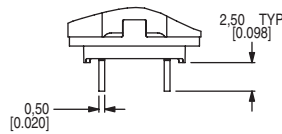

W 12" WIRE LEADS 22 AWG

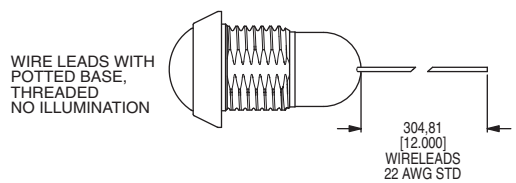
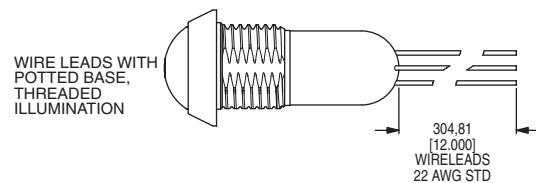
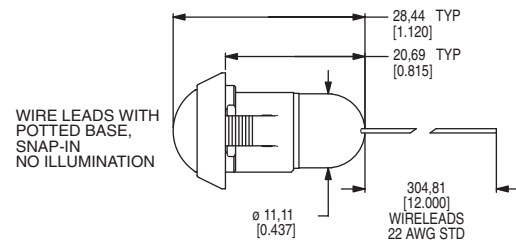
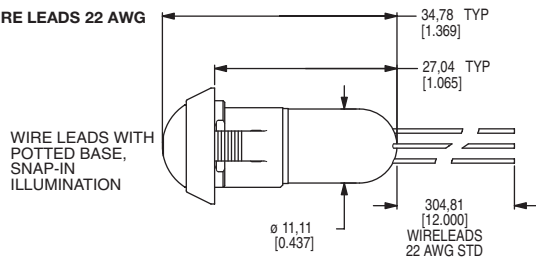

Wires: Black wires - Terminals
 Red wires - LED (+) Positive
 White wire - LED (-) Negative

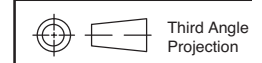

Dimensions are shown: mm (inches)
 Specifications and dimensions subject to change



AP Series Industrial Pushbutton Switch

Pushbutton

A

CONTACT MATERIAL



B GOLD

OPTION CODE	CONTACT MATERIAL
B	Gold

TERMINAL SEAL



E EPOXY

All models are epoxy sealed

HARDWARE

LOCK WASHER

Part Number 647D00000

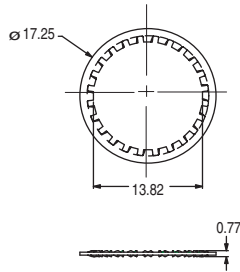

HEX NUT

Part number 515D00000

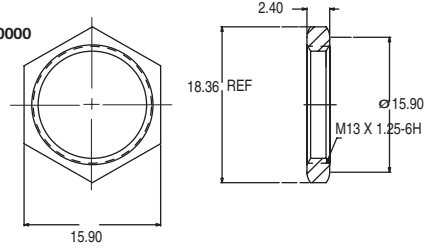

PANEL SEAL

Part Number 655D00000

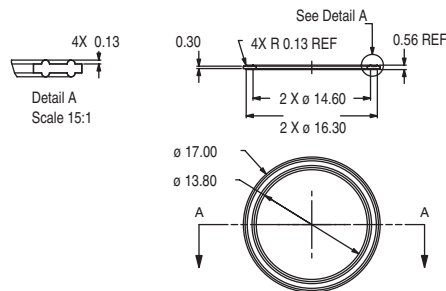

Caps available on next page

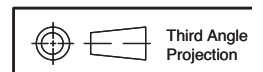

Third Angle Projection



Dimensions are shown: mm (inches)
Specifications and dimensions subject to change



AVAILABLE CAPS

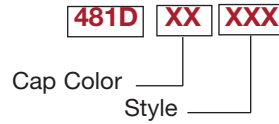

OPTION	CAP COLOR
01	WHITE
02	BLACK
03	RED
04	ORANGE
05	YELLOW
06	GREEN
07	BLUE
08	BROWN
09	GRAY

PART NUMBER	HOLE	STYLE
481DXX000	NO	DOME
481DXX001	YES	DOME
481DXX002	NO	EXTENDED DOME
481DXX003	YES	EXTENDED DOME
481DXX004	NO	CONCAVE
481DXX005	YES	CONCAVE

DOME

481DXX000 = NO HOLE
481DXX001 = HOLE

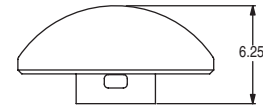
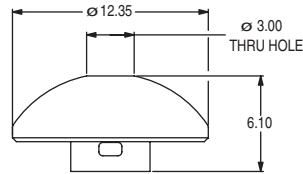

EXTENDED DOME

481DXX002 = NO HOLE
481DXX003 = HOLE

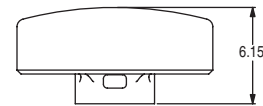
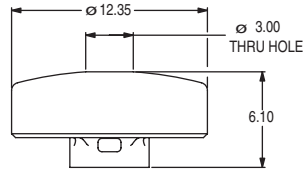

CONCAVE

481DXX004 = NO HOLE
481DXX005 = HOLE

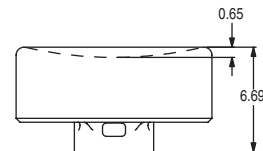
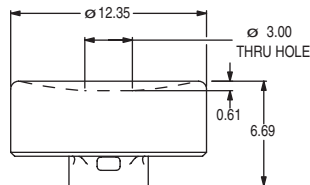

X-ON Electronics

Largest Supplier of Electrical and Electronic Components

Click to view similar products for [Pushbutton Switches](#) category:

Click to view products by [C&K](#) manufacturer:

Other Similar products are found below :

[LW1L-M1C10V-A](#) [LW2L-A1C20M-GD](#) [LW2L-M1C20M-A](#) [60324L](#) [M7E-HRN2](#) [67021K512](#) [67081K512X](#) [701PB580](#) [719-5504-000](#)
[MDPSSGLFS](#) [810KSV30B](#) [MML21KA3ABK](#) [MML23KA3AC05K-001](#) [MML23KW3AA01W](#) [8418K2](#) [8646AB6X718UL](#) [8646ABUL](#)
[FSDWH](#) [9001KXRK](#) [9001T8BK](#) [9533CD4+U574+U4922](#) [1203MRA](#) [A22EM01S](#) [A595](#) [1202A6](#) [12037A2ULCSA](#) [1203A2UL](#) [ABD122N-](#)
[B](#) [1211390004](#) [ABN111-Y](#) [ABN400-R](#) [1211500044](#) [1211580012](#) [1212MRA](#) [1232A6NF](#) [RA3CSH6A](#) [1241.1183.7047](#) [1241.2511](#)
[1241.3428](#) [1223A2ULCSA](#) [1223MRA](#) [1232AX2119](#) [1241.1183.8000](#) [1241.1183.8029](#) [1241.2506](#) [1241.2606](#) [12MA6](#) [1301940184](#)
[RELBARF6X10\(PLASTIC\)](#) [13435AG](#)