



APB Series Backlit Pushbutton Switch

Pushbutton
A

Features/Benefits

- IP67 sealed
- 1,000,000 life cycle
- Illumination
- Threaded or snap-in mounting
- RoHS compliant

Typical Applications

- Harsh environments
- Off-Road
- Industrial
- Medical
- Transportation
- Joystick control modules
- Gaming
- Military



Specifications

FUNCTION: SPST Momentary
 CONTACT ARRANGEMENT: N.O.
 MOUNTING TYPE:
 Snap-in (no panel seal)
 Threaded body (hex nut, lock washer, and panel seal gasket provided)
 Torque spec for threaded body: Do not exceed 8-9 in-lbs (0.9-1.0 N.m)

Mechanical

OPERATING LIFE: 1,000,000 cycles
 TOTAL TRAVEL: 2.1 ± 0.2 mm
 OPERATING POINT 1.55 ± 0.25 mm
 OVER TRAVEL: 0.6 min.
 OPERATING FORCE: 4N ± 1N standard configuration; other force option 2N ± 0.5N
 VIBRATION: 10-500 Hz 10g Max
 SHOCK: 60g 11ms sawtooth wave

Electrical

CONTACT RATING:
 200mA @ 24 V DC resistive (500,000 cycles)
 100mA @ 50 V DC resistive (500,000 cycles)
 400mA @ 32 V AC resistive (500,000 cycles)
 125mA @ 125 V AC resistive (1,000,000 cycles)
 DIELECTRIC STRENGTH: 1000 V AC min.
 INSULATION RESISTANCE: 1 G Ω @ 500 VDC
 INITIAL CONTACT RESISTANCE 50 mΩ max (without wire leads)
 BOUNCE TIME: <5 ms

Materials

HOUSING: PBT
 BASE: PBT
 CAP: Painted polycarbonate
 ACTUATOR:
 Illuminated: Clear polycarbonate
 INTERNAL SEAL: Silicone rubber
 TERMINALS: Copper alloy, gold over silver plating
 MOVABLE CONTACT: Copper alloy, gold over silver plating
 TERMINAL SEAL: Epoxy
 WIRE LEADS: UL1569 Black 22 AWG

Operating Environment

OPERATING TEMPERATURE: -40°C to 85°C
 ESD PROTECTION: 20 KV min.

Process Environment

SEALING: IP67 for threaded body
 IP65 for snap-in version (no panel seal)

NOTE: Specifications and materials listed above are for switches with standard options. For information on specific and custom switches, please contact Customer Service.

Build-A-Switch

To order, simply select desired option from each category and place in the appropriate box.

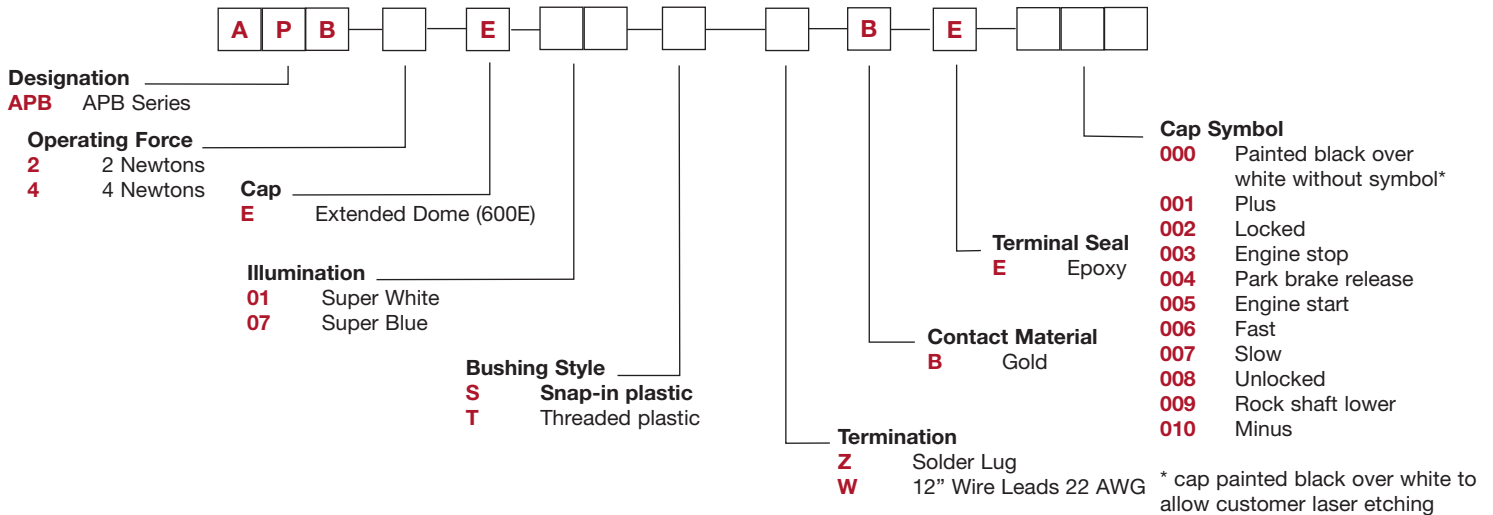

28 Jul 21

Dimensions are shown: Inches (mm)
 Specifications and dimensions subject to change

APB Series Backlit Pushbutton Switch



A
Pushbutton

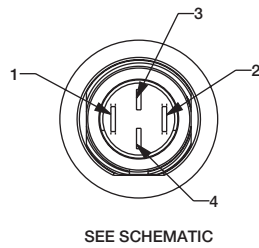
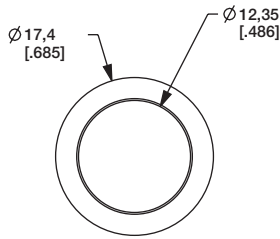
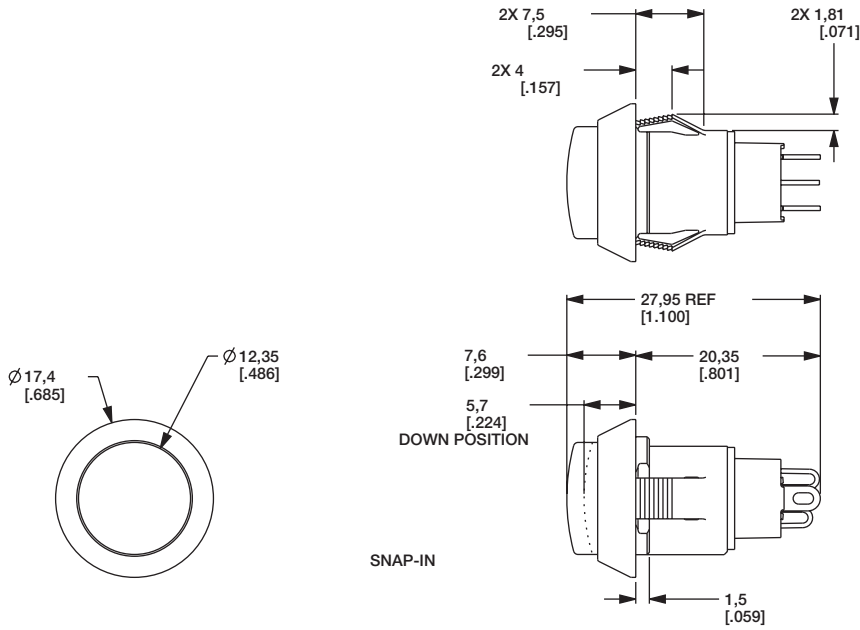

THREADED

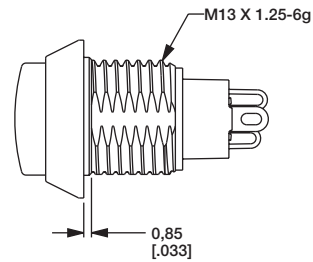

ELECTRICAL SCHEMATIC

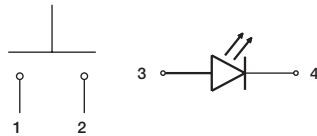

SPST-NO-DB

PANEL CUTOUT

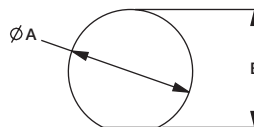

PANEL THICKNESS	DIM A (±0.05 MM)	DIM B (±0.05 MM)
1 MM [0.039 IN]	13.70 MM [0.539 IN]	13.00 MM [0.512 IN]
2 MM [0.079 IN]	13.80 MM [0.539 IN]	13.00 MM [0.512 IN]
3 MM [0.118 IN]	13.90 MM [0.547 IN]	13.10 MM [0.516 IN]
THREADED BODY MIN PANEL THICKNESS 1 MM	13.70 MM [0.539 IN]	13.00 MM [0.512 IN]

A 0.1 MM MIN CHAMFER ON THE LEADING EDGE OF MOUNTING HOLE IS RECOMMENDED FOR SNAP-IN VERSION.

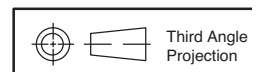



APB Series Backlit Pushbutton Switch

TERMINATION

Pushbutton

A

W 12" WIRE LEADS

Z SOLDER LUG

WIRE LEADS WITH POTTED BASE, SNAP-IN ILLUMINATION

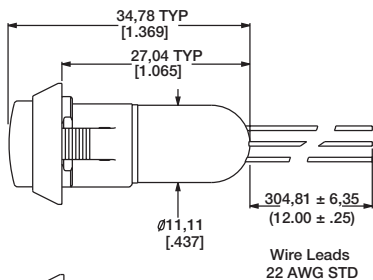

WIRE LEADS WITH POTTED BASE, THREADED ILLUMINATION

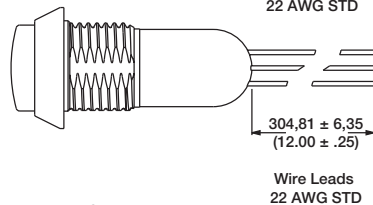

WIRES:
BLACK - TERMINALS
RED - LED (+) POSITIVE
WHITE - LED (-) NEGATIVE

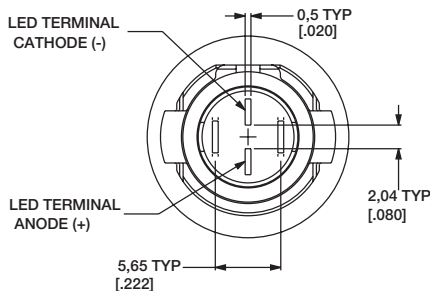
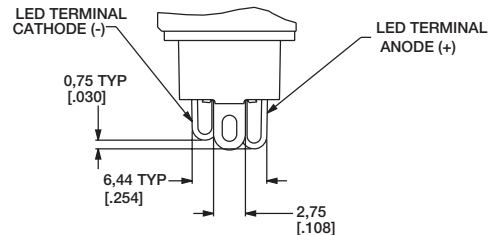
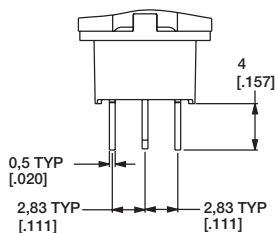

CONTACT MATERIAL



B GOLD

OPTION CODE	CONTACT MATERIAL
B	Gold

TERMINAL SEAL



E EPOXY

All models are epoxy sealed

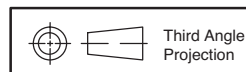

Third Angle
Projection



28 Jul 21

Dimensions are shown: Inches (mm)
Specifications and dimensions subject to change



CAP SYMBOLS

	-000		NO SYMBOL
	-001		PLUS
	-002		LOCKED
	-003		ENGINE STOP
	-004		PARK BRAKE RELEASE
	-005		ENGINE START

	-006		FAST
	-007		SLOW
	-008		UNLOCKED
	-009		ROCK SHAFT LOWER
	-010		MINUS

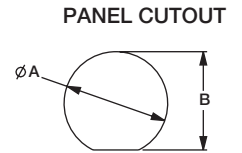

Panel Orientation
Flat indicates bottom

See chart on previous page
for dimensions

NOTES:
1. ALL GRAPHICS MUST BE POSITIONED AS SHOWN, PERPENDICULAR TO ALIGNMENT FEATURE ON UNDERSIDE OF CAP.
2. GRAPHIC MARKING MUST BE ALIGNED WITH THE FLAT FEATURE ON THE UNDERSIDE OF THE CAP AS SHOWN, TOLERANCE $\pm 3^\circ$

HARDWARE

LOCK WASHER
Part Number 647D00A47

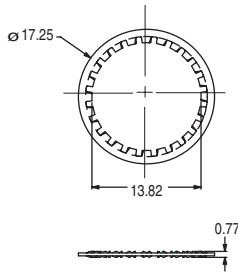

HEX NUT
Part number 515D00000

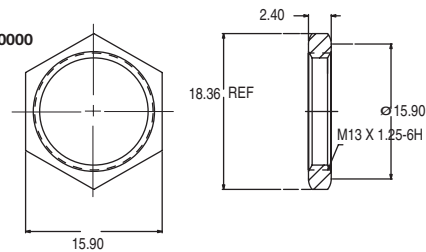

PANEL SEAL
Part Number 655D00000

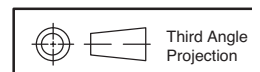
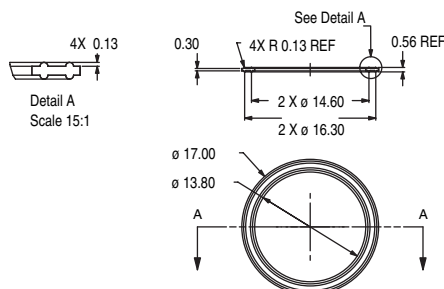

X-ON Electronics

Largest Supplier of Electrical and Electronic Components

Click to view similar products for [Pushbutton Switches](#) category:

Click to view products by [C&K](#) manufacturer:

Other Similar products are found below :

[8940K2012](#) [LW1L-M1C10V-A](#) [LW1L-M1C70-A](#) [LW2L-A1C20M-GD](#) [LW2L-M1C20M-A](#) [60324L](#) [M22-D-R-GB0/K11](#) [M7E-HRN2](#)
[67021K512](#) [67081K512X](#) [701PB580](#) [7199K101](#) [810K12910](#) [810KSV30B](#) [MML21EA2ADK](#) [MML21KA3ABK](#) [MML23KA3AC05K-001](#)
[MML23KW3AA01W](#) [8418K2](#) [8442K3](#) [8450K1](#) [860K11911T01A](#) [861901](#) [861K11911T01A07](#) [861K13810T00A14](#) [861K13911](#)
[8646AB6X718UL](#) [8646ABUL](#) [9001KXRK](#) [907AYY100](#) [PMHD155A1](#) [9533CD4+U574+U4922](#) [95-414.000](#) [99-450.837](#) [99-453.837](#)
[PV3H2B0NN-341](#) [1203MRA](#) [A22NZBGANGA](#) [A22NZBNANGA](#) [A22NZMPATRA](#) [A2PMA1X03EC56](#) [A3A-5123-02](#) [A3A-7140](#) [A3A-7310](#) [A3A-7340](#) [A3U-TMW-A2C-5M](#) [A595](#) [12037A2ULCSA](#) [ABD122N-B](#) [1211390004](#)