

## Features/Benefits

- **D\*Sub Connector Type**
- **Contacts installed in factory**
- **Multiple contacts configuration: Solder Cup, 90° bent, Straight PC, Wire-wrap**
- **From 9 to 50 ways**

## Typical Applications

- **Payloads PCB**
- **Launchers**
- **PCB Test**

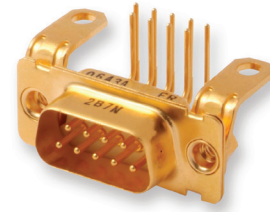

Connectors with solder type or wire-wrap type termination contacts size 20 inserted into one-piece insulators.

Termination types available:

- Solder Bucket terminations
- Straight PCB solder terminations
- 90° bent PCB solder terminations
- Wire-wrap terminations

Combination arrangements available for size 8 snap-in coaxial, power, or high voltage contacts

**Connectors supplied without coaxial power or high voltage contacts. Power and coaxial contacts have to be ordered separately but signal contacts are installed in factory.**

**Signal contact are solder bucket type. Other type could be asked under request.**

Packaging unit: 1 piece (plastic bag)

Dust cap supplied with each connector, only for quality level ESA/ESCC

## How to order – ESA/ESCC Quality Level

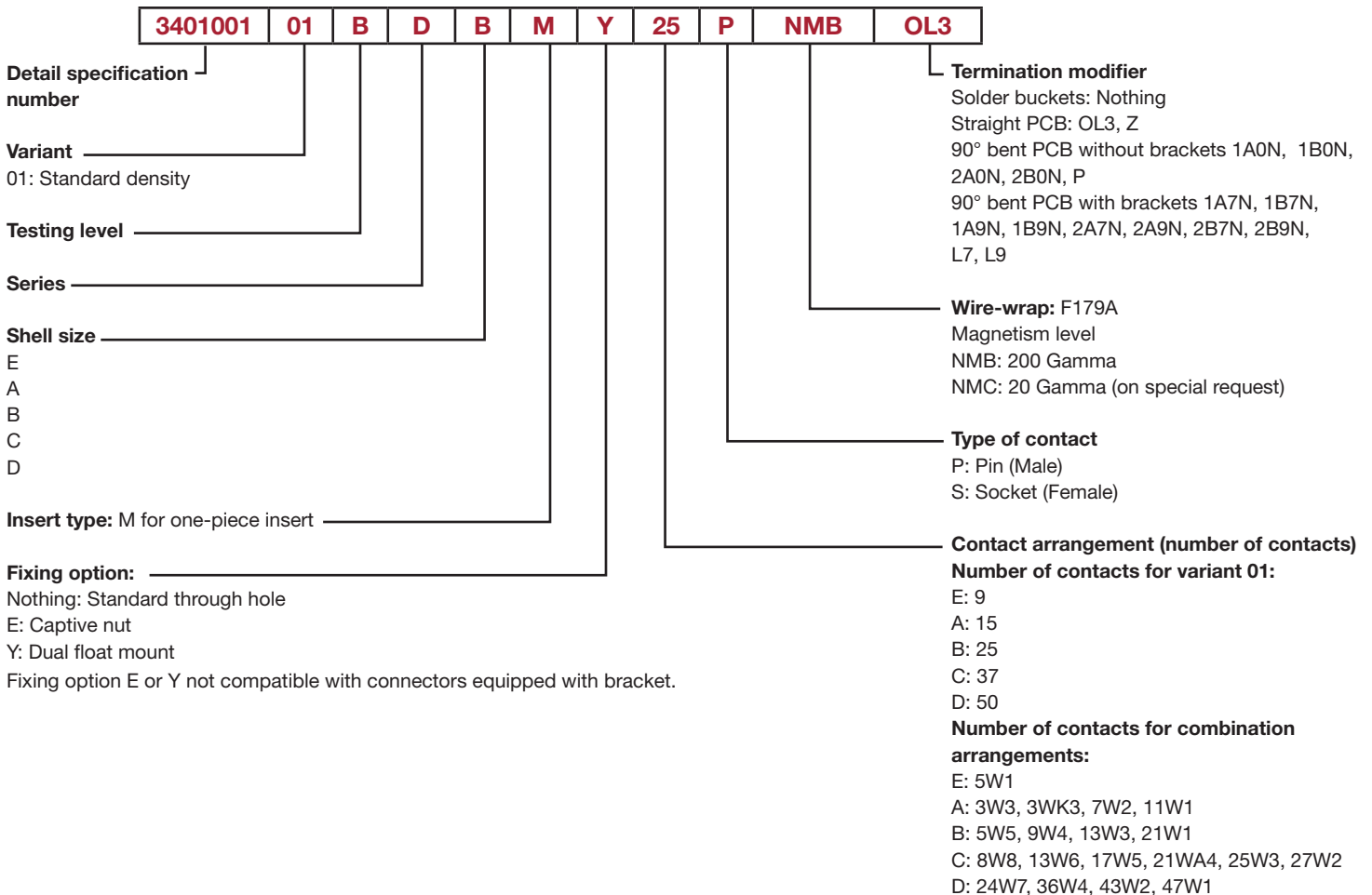

# 3401-001 D\*M Standard Density

## How to order – FR022 Quality Level

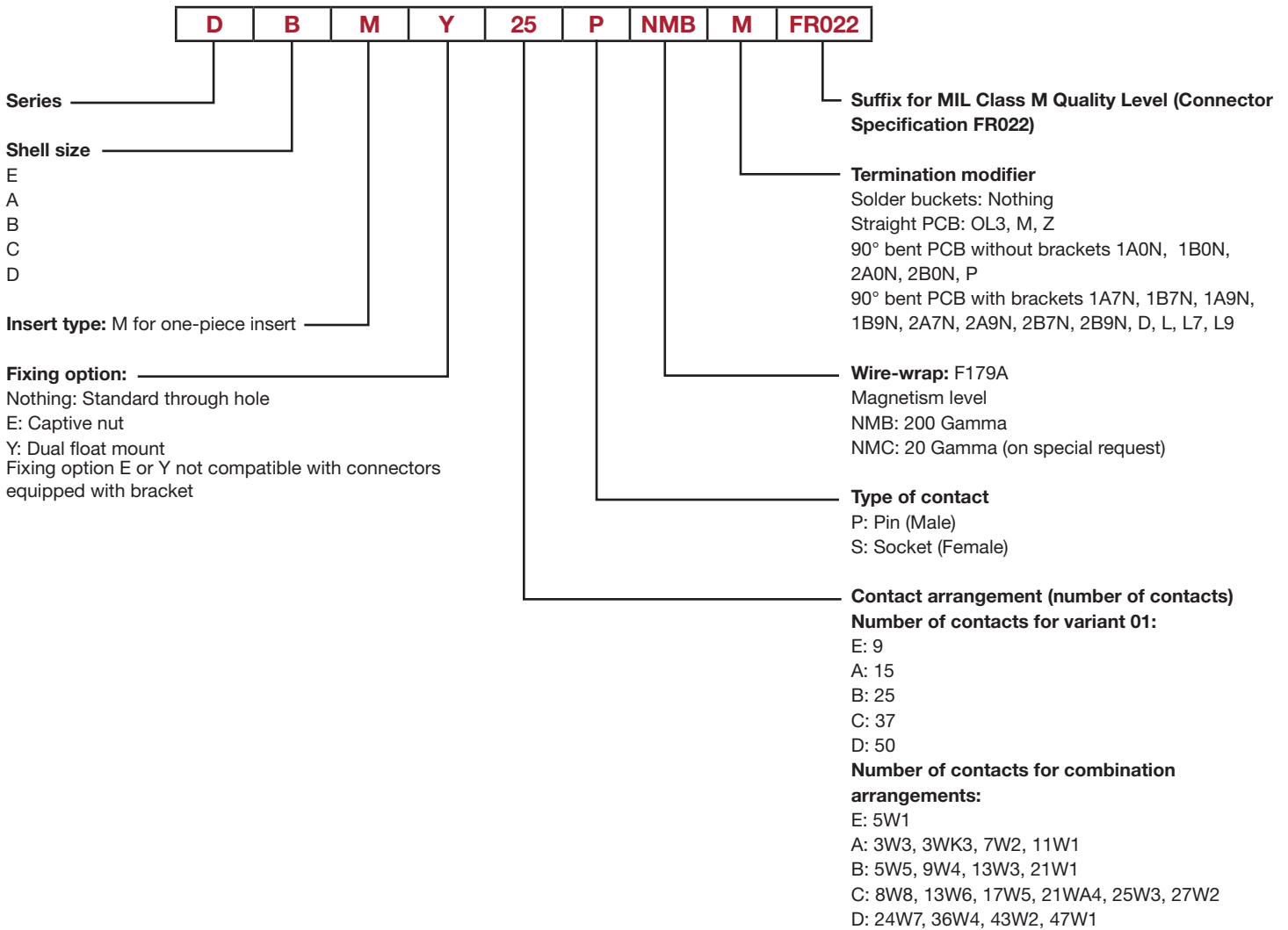

# 3401-001 D\*M Standard Density

## Specific Dimensions

## Termination Types

Solder Bucket

Straight PCB Solder

90° Bent PCB Solder / Without Bracket / European Footprint

90° Bent PCB Solder / With Brackets / European Footprint

90° Bent PCB Solder / Without Brackets / U.S. Footprint

90° Bent PCB Solder / With Brackets / U.S. Footprint

Wire-Wrap

Male Connector

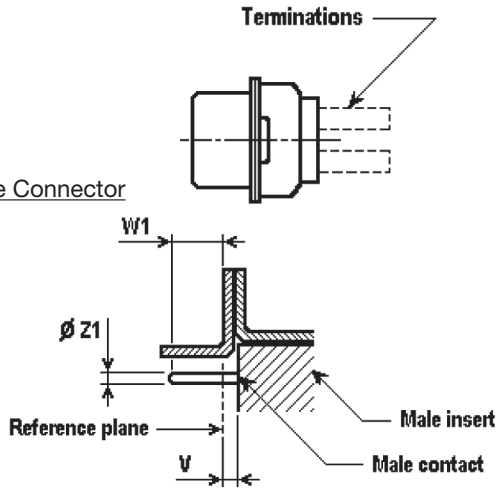

Female Connector

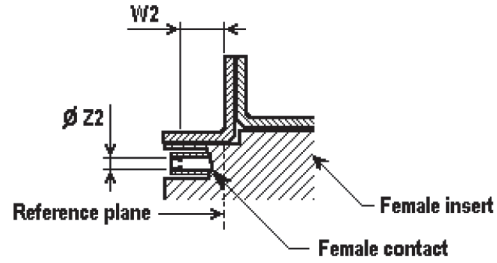

Ø Z2: to accommodate a 0,99 (.039) / 1,04 (.041) diameter pin

Shell Size	V max	W1 min (Full pin diameter)	W1 max (Full pin length)	ØZ1 min	ØZ1 max	W2 min (Square ended pin)
E	0,40 (.016)	4,47 (.176)	5,33 (.210)	0,99 (.039)	1,04 (.041)	4,36 (.172)
A	0,40 (.016)	4,47 (.176)	5,33 (.210)	0,99 (.039)	1,04 (.041)	4,36 (.172)
B	0,60 (.024)	4,47 (.176)	5,33 (.210)	0,99 (.039)	1,04 (.041)	4,36 (.172)
C	0,60 (.024)	4,47 (.176)	5,33 (.210)	0,99 (.039)	1,04 (.041)	4,36 (.172)
D	0,60 (.024)	4,47 (.176)	5,33 (.210)	0,99 (.039)	1,04 (.041)	4,36 (.172)

## Weights

Max Weight (grams) without contacts or accessories	Shell Size	Weight (Grams)	
		Male	Female
	E	4,5	5,0
	A	5,5	7,0
	B	9,0	10,0
	C	12,5	13,5
	D	13,5	15,0

For the total connector weight, add the weight of the contacts and of the eventual accessories.\*

\* For the weight of the contacts, refer to the tables on the following pages.  
For dual-float amount (Y) weight (if applicable), added 0,60 grams.  
For captive-nut, (E) weight (if applicable), added 0,65 grams.

# 3401-001 D\*M Standard Density

## Solder Bucket Terminations:

### Specific Dimensions

Sizes E, A, B, C

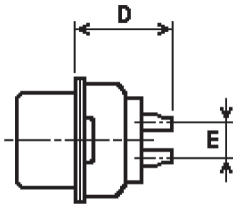

Size D

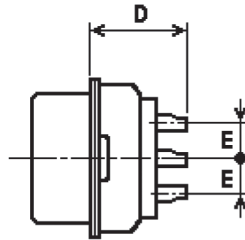

Termination

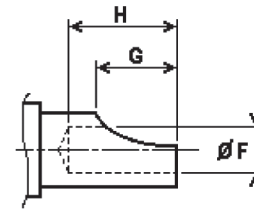

Contacts	Shell Size	D ± 0,60 (.024)	E Typical	ØF + 0,05 (.002) / 0	G ± 0,55 (.022)	H min	Pitch between contacts
Male	E	9,60 (.378)	2,84 (.112)	1,10 (.043)	1,95 (.077)	2,40 (.094)	2,74 (.108)
	A	9,60 (.378)	2,84 (.112)	1,10 (.043)	1,95 (.077)	2,40 (.094)	2,74 (.108)
	B	9,80 (.386)	2,84 (.112)	1,10 (.043)	1,95 (.077)	2,40 (.094)	2,76 (.109)
	C	9,80 (.386)	2,84 (.112)	1,10 (.043)	1,95 (.077)	2,40 (.094)	2,76 (.109)
	D	9,80 (.386)	2,84 (.112)	1,10 (.043)	1,95 (.077)	2,40 (.094)	2,76 (.109)
Female	E	9,60 (.378)	2,84 (.112)	1,10 (.043)	1,95 (.077)	2,40 (.094)	2,74 (.108)
	A	9,60 (.378)	2,84 (.112)	1,10 (.043)	1,95 (.077)	2,40 (.094)	2,74 (.108)
	B	9,60 (.378)	2,84 (.112)	1,10 (.043)	1,95 (.077)	2,40 (.094)	2,76 (.109)
	C	9,60 (.378)	2,84 (.112)	1,10 (.043)	1,95 (.077)	2,40 (.094)	2,76 (.109)
	D	9,60 (.378)	2,84 (.112)	1,10 (.043)	1,95 (.077)	2,40 (.094)	2,76 (.109)

Termination Modifier: Nothing

### Weights

	Shell Size	Male Contact	Female Contact
<b>Max Weight (grams) per contact</b>		0,19	0,22
<b>Max Weight (grams) of all contacts per size</b>	E	1,71	1,98
	A	2,85	3,30
	B	4,75	5,50
	C	7,03	8,14
	D	9,50	11,00

### Recommended instruction for wire stripping:

Cut wires to length and strip insulation per illustration.  
Check for broken or frayed wires.  
Accepted wire sizes: insulated AWG20, AWG22, AWG24

#### Recommended wire trim length

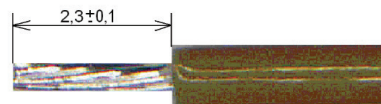

# 3401-001 D\*M Standard Density

## Cross References

Solder bucket

### Standard

Description ESA/ESCC	Part Number
340100101B DEM 9P NMB	C115371-5000
340100101B DEM 9S NMB	C115371-5001
340100101B DAM 15P NMB	C115371-5004
340100101B DAM 15S NMB	C115371-5005
340100101B DBM 25P NMB	C115371-5014
340100101B DBM 25S NMB	C115371-5015
340100101B DCM 37P NMB	C115371-5026
340100101B DCM 37S NMB	C115371-5027
340100101B DDM 50P NMB	C115371-5040
340100101B DDM 50S NMB	C115371-5041

Description FR022	Part Number
DEM 9P NMB-FR022	C115371-3000
DEM 9S NMB-FR022	C115371-3001
DAM 15P NMB-FR022	C115371-3004
DAM 15S NMB-FR022	C115371-3005
DBM 25P NMB-FR022	C115371-3014
DBM 25S NMB-FR022	C115371-3015
DCM 37P NMB-FR022	C115371-3026
DCM 37S NMB-FR022	C115371-3027
DDM 50P NMB-FR022	C115371-3040
DDM 50S NMB-FR022	C115371-3041

### Option Y

Description ESA/ESCC	Part Number
340100101B DEMY 9P NMB	C115371-5050
340100101B DEMY 9S NMB	C115371-5051
340100101B DAMY 15P NMB	C115371-5054
340100101B DAMY 15S NMB	C115371-5055
340100101B DBMY 25P NMB	C115371-5064
340100101B DBMY 25S NMB	C115371-5065
340100101B DCMY 37P NMB	C115371-5076
340100101B DCMY 37S NMB	C115371-5077
340100101B DDMY 50P NMB	C115371-5090
340100101B DDMY 50S NMB	C115371-5091

Description FR022	Part Number
DEMY 9P NMB-FR022	C115371-3050
DEMY 9S NMB-FR022	C115371-3051
DAMY 15P NMB-FR022	C115371-3054
DAMY 15S NMB-FR022	C115371-3055
DBMY 25P NMB-FR022	C115371-3064
DBMY 25S NMB-FR022	C115371-3065
DCMY 37P NMB-FR022	C115371-3076
DCMY 37S NMB-FR022	C115371-3077
DDMY 50P NMB-FR022	C115371-3090
DDMY 50S NMB-FR022	C115371-3091

### Option E

Description ESA/ESCC	Part Number
340100101B DEME 9P NMB	C115371-5100
340100101B DEME 9S NMB	C115371-5101
340100101B DAME 15P NMB	C115371-5104
340100101B DAME 15S NMB	C115371-5105
340100101B DBME 25P NMB	C115371-5114
340100101B DBME 25S NMB	C115371-5115
340100101B DCME 37P NMB	C115371-5126
340100101B DCME 37S NMB	C115371-5127
340100101B DDME 50P NMB	C115371-5140
340100101B DDME 50S NMB	C115371-5141

Description FR022	Part Number
DEME 9P NMB-FR022	C115371-3100
DEME 9S NMB-FR022	C115371-3101
DAME 15P NMB-FR022	C115371-3104
DAME 15S NMB-FR022	C115371-3105
DBME 25P NMB-FR022	C115371-3114
DBME 25S NMB-FR022	C115371-3115
DCME 37P NMB-FR022	C115371-3126
DCME 37S NMB-FR022	C115371-3127
DDME 50P NMB-FR022	C115371-3140
DDME 50S NMB-FR022	C115371-3141



Dimensions are shown in mm (inch)  
Dimensions subject to change

# 3401-001 D\*M Standard Density

## Straight PCB solder Terminations type OL3, M, Z

### Specific Dimensions

Sizes E, A, B, C

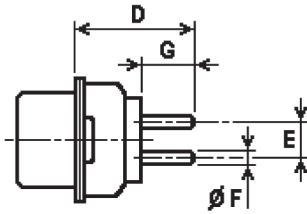

Size D

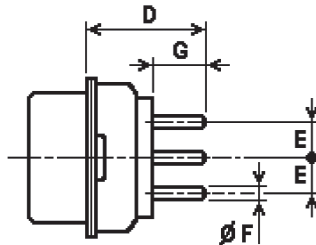

Termination Modifier	$\pm 0,05$ ( $.002$ ) $\varnothing F$	$\pm 0,20$ ( $.008$ ) G
OL3	0,60 ( $.024$ )	4,15 ( $.163$ )
M*	0,76 ( $.030$ )	3,65 ( $.144$ )
Z	0,76 ( $.030$ )	4,65 ( $.183$ )

Contacts	Shell Size	D min	D max	E Typical	Pitch between contacts
Male	E	10,00 ( $.394$ )	11,20 ( $.441$ )	2,84 ( $.112$ )	2,74 ( $.108$ )
	A	10,00 ( $.394$ )	11,20 ( $.441$ )	2,84 ( $.112$ )	2,74 ( $.108$ )
	B	10,20 ( $.402$ )	11,40 ( $.449$ )	2,84 ( $.112$ )	2,76 ( $.109$ )
	C	10,20 ( $.402$ )	11,40 ( $.449$ )	2,84 ( $.112$ )	2,76 ( $.109$ )
	D	10,20 ( $.402$ )	11,40 ( $.449$ )	2,84 ( $.112$ )	2,76 ( $.109$ )
Female	E	10,00 ( $.394$ )	11,20 ( $.441$ )	2,84 ( $.112$ )	2,74 ( $.108$ )
	A	10,00 ( $.394$ )	11,20 ( $.441$ )	2,84 ( $.112$ )	2,74 ( $.108$ )
	B	10,00 ( $.394$ )	11,20 ( $.441$ )	2,84 ( $.112$ )	2,76 ( $.109$ )
	C	10,00 ( $.394$ )	11,20 ( $.441$ )	2,84 ( $.112$ )	2,76 ( $.109$ )
	D	10,00 ( $.394$ )	11,20 ( $.441$ )	2,84 ( $.112$ )	2,76 ( $.109$ )

Termination Modifier: OL3, M, Z

For other termination modifier, consult factory

### Weights

	Shell Size	Male Contact	Female Contact
<b>Max Weight (grams) per contact</b>		0,17	0,20
<b>Max Weight (grams) of all contacts per size</b>	E	1,53	1,80
	A	2,55	3,00
	B	4,25	5,00
	C	6,29	7,40
	D	8,50	10,00

# 3401-001 D\*M Standard Density

## Cross References

Solder bucket

### Standard

Description ESA/ESCC	Part Number
340100101B DEM 9P NMB OL3	C115371-5150
340100101B DEM 9S NMB OL3	C115371-5151
340100101B DAM 15P NMB OL3	C115371-5154
340100101B DAM 15S NMB OL3	C115371-5155
340100101B DBM 25P NMB OL3	C115371-5160
340100101B DBM 25S NMB OL3	C115371-5161
340100101B DCM 37P NMB OL3	C115371-5170
340100101B DCM 37S NMB OL3	C115371-5171
340100101B DDM 50P NMB OL3	C115371-5182
340100101B DDM 50S NMB OL3	C115371-5183
340100101B DEM 9P NMB Z	C115371-5300
340100101B DEM 9S NMB Z	C115371-5301
340100101B DAM 15P NMB Z	C115371-5304
340100101B DAM 15S NMB Z	C115371-5305
340100101B DBM 25P NMB Z	C115371-5310
340100101B DBM 25S NMB Z	C115371-5311
340100101B DCM 37P NMB Z	C115371-5320
340100101B DCM 37S NMB Z	C115371-5321
340100101B DDM 50P NMB Z	C115371-5332
340100101B DDM 50S NMB Z	C115371-5333

Description FR022	Part Number
DEM 9P NMB OL3-FR022	C115371-3150
DEM 9S NMB OL3-FR022	C115371-3151
DAM 15P NMB OL3-FR022	C115371-3154
DAM 15S NMB OL3-FR022	C115371-3155
DBM 25P NMB OL3-FR022	C115371-3160
DBM 25S NMB OL3-FR022	C115371-3161
DCM 37P NMB OL3-FR022	C115371-3170
DCM 37S NMB OL3-FR022	C115371-3171
DDM 50P NMB OL3-FR022	C115371-3182
DDM 50S NMB OL3-FR022	C115371-3183
DEM 9P NMBZ-FR022	C115371-3300
DEM 9S NMBZ-FR022	C115371-3301
DAM 15P NMBZ-FR022	115371-3304
DAM 15S NMBZ-FR022	115371-3305
DBM 25P NMBZ-FR022	115371-3310
DBM 25S NMBZ-FR022	115371-3311
DCM 37P NMBZ-FR022	115371-3320
DCM 37S NMBZ-FR022	115371-3321
DDM 50P NMBZ-FR022	115371-3332
DDM 50S NMBZ-FR022	115371-3333

### Option Y

Description ESA/ESCC	Part Number
340100101B DEMY 9P NMB OL3	C115371-5200
340100101B DEMY 9S NMB OL3	C115371-5201
340100101B DAMY 15P NMB OL3	C115371-5204
340100101B DAMY 15S NMB OL3	C115371-5205
340100101B DBMY 25P NMB OL3	C115371-5210
340100101B DBMY 25S NMB OL3	C115371-5211
340100101B DCMY 37P NMB OL3	C115371-5220
340100101B DCMY 37S NMB OL3	C115371-5221
340100101B DDMY 50P NMB OL3	C115371-5232
340100101B DDMY 50S NMB OL3	C115371-5233
340100101B DEMY 9P NMB Z	C115371-5350
340100101B DEMY 9S NMB Z	C115371-5351
340100101B DAMY 15P NMB Z	C115371-5354
340100101B DAMY 15S NMB Z	C115371-5355
340100101B DBMY 25P NMB Z	C115371-5360
340100101B DBMY 25S NMB Z	C115371-5361
340100101B DCMY 37P NMB Z	C115371-5370
340100101B DCMY 37S NMB Z	C115371-5371
340100101B DDMY 50P NMB Z	C115371-5382
340100101B DDMY 50S NMB Z	C115371-5383

Description FR022	Part Number
DEMY 9P NMB OL3-FR022	C115371-3200
DEMY 9S NMB OL3-FR022	C115371-3201
DAMY 15P NMB OL3-FR022	C115371-3204
DAMY 15S NMB OL3-FR022	C115371-3205
DBMY 25P NMB OL3-FR022	C115371-3210
DBMY 25S NMB OL3-FR022	C115371-3211
DCMY 37P NMB OL3-FR022	C115371-3220
DCMY 37S NMB OL3-FR022	C115371-3221
DDMY 50P NMB OL3-FR022	C115371-3232
DDMY 50S NMB OL3-FR022	C115371-3233
DEMY 9P NMBZ-FR022	C115371-3350
DEMY 9S NMBZ-FR022	C115371-3351
DAMY 15P NMBZ-FR022	C115371-3354
DAMY 15S NMBZ-FR022	C115371-3355
DBMY 25P NMBZ-FR022	C115371-3360
DBMY 25S NMBZ-FR022	C115371-3361
DCMY 37P NMBZ-FR022	C115371-3370
DCMY 37S NMBZ-FR022	C115371-3371
DDMY 50P NMBZ-FR022	C115371-3382
DDMY 50S NMBZ-FR022	C115371-3383



Dimensions are shown in mm (inch)  
Dimensions subject to change

# 3401-001 D\*M Standard Density

## Option E

Description ESA/ESCC	Part Number
340100101B DEME 9P NMB OL3	C115371-5250
340100101B DEME 9S NMB OL3	C115371-5251
340100101B DAME 15P NMB OL3	C115371-5254
340100101B DAME 15S NMB OL3	C115371-5255
340100101B DBME 25P NMB OL3	C115371-5260
340100101B DBME 25S NMB OL3	C115371-5261
340100101B DCME 37P NMB OL3	C115371-5270
340100101B DCME 37S NMB OL3	C115371-5271
340100101B DDME 50P NMB OL3	C115371-5282
340100101B DDME 50S NMB OL3	C115371-5283
340100101B DEME 9P NMB Z	C115371-5400
340100101B DEME 9S NMB Z	C115371-5401
340100101B DAME 15P NMB Z	C115371-5404
340100101B DAME 15S NMB Z	C115371-5405
340100101B DBME 25P NMB Z	C115371-5410
340100101B DBME 25S NMB Z	C115371-5411
340100101B DCME 37P NMB Z	C115371-5420
340100101B DCME 37S NMB Z	C115371-5421
340100101B DDME 50P NMB Z	C115371-5432
340100101B DDME 50S NMB Z	C115371-5433

Description FR022	Part Number
DEME 9P NMB OL3-FR022	C115371-3250
DEME 9S NMB OL3-FR022	C115371-3251
DAME 15P NMB OL3-FR022	C115371-3254
DAME 15S NMB OL3-FR022	C115371-3255
DBME 25P NMB OL3-FR022	C115371-3260
DBME 25S NMB OL3-FR022	C115371-3261
DCME 37P NMB OL3-FR022	C115371-3270
DCME 37S NMB OL3-FR022	C115371-3271
DDME 50P NMB OL3-FR022	C115371-3282
DDME 50S NMB OL3-FR022	C115371-3283
DEME 9P NMBZ-FR022	C115371-3400
DEME 9S NMBZ-FR022	C115371-3401
DAME 15P NMBZ-FR022	C115371-3404
DAME 15S NMBZ-FR022	C115371-3405
DBME 25P NMBZ-FR022	C115371-3410
DBME 25S NMBZ-FR022	C115371-3411
DCME 37P NMBZ-FR022	C115371-3420
DCME 37S NMBZ-FR022	C115371-3421
DDME 50P NMBZ-FR022	C115371-3432
DDME 50S NMBZ-FR022	C115371-3433



# 3401-001 D\*M Standard Density

90° Bent PCB solder Terminations / Without Brackets / US Footprint type P.

## Specific Dimensions

Sizes E, A, B, C

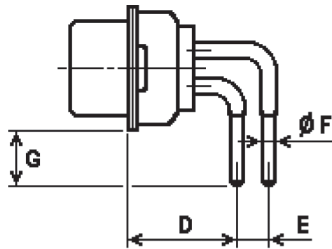

Size D

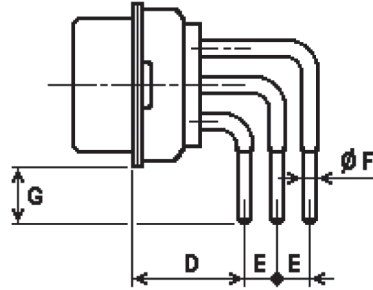

Termination Modifier	ØF ± 0,05 (.002)	E Typical
P	0,76 (.030)	2,84 (.112)

Contacts	Shell Size	D min	D max	G ± 0.37 (.015)	Pitch between contacts
Male	E	6,94 (.273)	7,44 (.293)	4,33 (.170)	2,74 (.108)
	A	6,94 (.273)	7,44 (.293)	4,33 (.170)	2,74 (.108)
	B	6,94 (.273)	7,44 (.293)	4,33 (.170)	2,76 (.109)
	C	6,94 (.273)	7,44 (.293)	4,33 (.170)	2,76 (.109)
	D	6,94 (.273)	7,44 (.293)	4,33 (.170)	2,76 (.109)
Female	E	6,94 (.273)	7,44 (.293)	4,33 (.170)	2,74 (.108)
	A	6,94 (.273)	7,44 (.293)	4,33 (.170)	2,74 (.108)
	B	6,94 (.273)	7,44 (.293)	4,33 (.170)	2,76 (.109)
	C	6,94 (.273)	7,44 (.293)	4,33 (.170)	2,76 (.109)
	D	6,94 (.273)	7,44 (.293)	4,33 (.170)	2,76 (.109)

Termination Modifier: P

For other termination modifier, consult factory

## Weights

	Shell Size	Male Contact	Female Contact
<b>Max Weight (grams) per contact</b>		0,22 / 0,26 / 0,30	0,27 / 0,32 / 0,35
<b>Max Weight (grams) of all contacts per size</b>	E	2,18	2,68
	A	3,62	4,45
	B	6,02	7,40
	C	8,90	10,94
	D	13,00	15,66

# 3401-001 D\*M Standard Density

## Cross References

90° bent PCB (without brackets)

### Standard

Description ESA/ESCC	Part Number
340100101B DEM 9P NMB P	C115331-9016
340100101B DEM 9S NMB P	C115331-9017
340100101B DAM 15P NMB P	C115371-9020
340100101B DAM 15S NMB P	C115371-9021
340100101B DBM 25P NMB P	C115371-9026
340100101B DBM 25S NMB P	C115371-9027
340100101B DCM 37P NMB P	C115371-9036
340100101B DCM 37S NMB P	C115371-9037
340100101B DDM 50P NMB P	C115371-9048
340100101B DDM 50S NMB P	C115371-9049

Description FR022	Part Number
DEM 9P NMBP-FR022	C115371-0000
DEM 9S NMBP-FR022	C115371-0001
DAM 15P NMBP-FR022	C115371-0004
DAM 15S NMBP-FR022	C115371-0005
DBM 25P NMBP-FR022	C115371-0010
DBM 25S NMBP-FR022	C115371-0011
DCM 37P NMBP-FR022	C115371-0020
DCM 37S NMBP-FR022	C115371-0021
DDM 50P NMBP-FR022	C115371-0032
DDM 50S NMBP-FR022	C115371-0033

### Option Y

Description ESA/ESCC	Part Number
340100101B DEMY 9P NMB P	C115331-9058
340100101B DEMY 9S NMB P	C115331-9059
340100101B DAMY 15P NMB P	C115371-9062
340100101B DAMY 15S NMB P	C115371-9063
340100101B DBMY 25P NMB P	C115371-9068
340100101B DBMY 25S NMB P	C115371-9069
340100101B DCMY 37P NMB P	C115371-9078
340100101B DCMY 37S NMB P	C115371-9079
340100101B DDMY 50P NMB P	C115371-9090
340100101B DDMY 50S NMB P	C115371-9091

Description FR022	Part Number
DEMY 9P NMBP-FR022	C115371-0042
DEMY 9S NMBP-FR022	C115371-0043
DAMY 15P NMBP-FR022	C115371-0046
DAMY 15S NMBP-FR022	C115371-0047
DBMY 25P NMBP-FR022	C115371-0052
DBMY 25S NMBP-FR022	C115371-0053
DCMY 37P NMBP-FR022	C115371-0062
DCMY 37S NMBP-FR022	C115371-0063
DDMY 50P NMBP-FR022	C115371-0074
DDMY 50S NMBP-FR022	C115371-0075

### Option E

Description ESA/ESCC	Part Number
340100101B DEME 9P NMB P	C115331-9100
340100101B DEME 9S NMB P	C115331-9101
340100101B DAME 15P NMB P	C115371-9104
340100101B DAME 15S NMB P	C115371-9105
340100101B DBME 25P NMB P	C115371-9110
340100101B DBME 25S NMB P	C115371-9111
340100101B DCME 37P NMB P	C115371-9120
340100101B DCME 37S NMB P	C115371-9121
340100101B DDME 50P NMB P	C115371-9132
340100101B DDME 50S NMB P	C115371-9133

Description FR022	Part Number
DEME 9P NMBP-FR022	C115371-0084
DEME 9S NMBP-FR022	C115371-0085
DAME 15P NMBP-FR022	C115371-0088
DAME 15S NMBP-FR022	C115371-0089
DBME 25P NMBP-FR022	C115371-0094
DBME 25S NMBP-FR022	C115371-0095
DCME 37P NMBP-FR022	C115371-0104
DCME 37S NMBP-FR022	C115371-0105
DDME 50P NMBP-FR022	C115371-0116
DDME 50S NMBP-FR022	C115371-0117



Dimensions are shown in mm (inch)  
Dimensions subject to change

# 3401-001 D\*M Standard Density

90° Bent PCB solder Terminations / Without Brackets / European Footprint type 1A0N – 1B0N – 2A0N – 2B0N

## Specific Dimensions

Sizes E, A, B, C

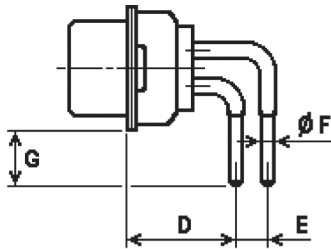

Size D

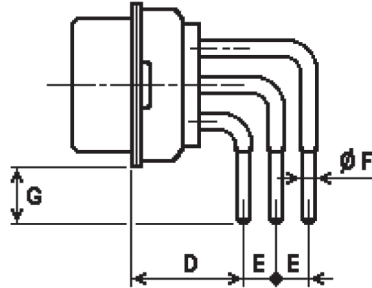

Termination Modifier	ØF ± 0,05 (.002)	E Typical
1A0N	0,60 (.024)	2,54 (.100)
1B0N	0,60 (.024)	2,84 (.112)
2A0N	0,76 (.030)	2,54 (.100)
2B0N	0,76 (.030)	2,84 (.112)

Contacts	Shell Size	D min	D max	G ± 0.30 (.012)	Pitch between contacts
Male	E	10,10 (.398)	10,30 (.406)	5,00 (.197)	2,74 (.108)
	A	10,10 (.398)	10,30 (.406)	5,00 (.197)	2,74 (.108)
	B	10,30 (.406)	10,50 (.413)	5,00 (.197)	2,76 (.109)
	C	10,30 (.406)	10,50 (.413)	5,00 (.197)	2,76 (.109)
	D	10,30 (.406)	10,50 (.413)	5,00 (.197)	2,76 (.109)
Female	E	10,10 (.398)	10,30 (.406)	5,00 (.197)	2,74 (.108)
	A	10,10 (.398)	10,30 (.406)	5,00 (.197)	2,74 (.108)
	B	10,10 (.398)	10,30 (.406)	5,00 (.197)	2,76 (.109)
	C	10,10 (.398)	10,30 (.406)	5,00 (.197)	2,76 (.109)
	D	10,10 (.398)	10,30 (.406)	5,00 (.197)	2,76 (.109)

Termination Modifier: 1A0N, 1B0N, 2A0N, 2B0N  
For other termination modifier, consult factory

## Weights

	Shell Size	Male Contact	Female Contact
<b>Max Weight (grams) per contact</b>		0,24 / 0,28 / 0,32	0,29 / 0,34 / 0,37
<b>Max Weight (grams) of all contacts per size</b>	E	2,36	2,86
	A	3,92	4,75
	B	6,52	7,90
	C	9,64	11,68
	D	14,00	16,66

# 3401-001 D\*M Standard Density

## Cross References

90° bent PCB (without brackets)

### Standard

Description ESA/ESCC	Part Number
340100101B DEM 9P NMB 1AON	C115371-5600
340100101B DEM 9S NMB 1AON	C115371-5601
340100101B DAM 15P NMB 1AON	C115371-5604
340100101B DAM 15S NMB 1AON	C115371-5605
340100101B DBM 25P NMB 1AON	C115371-5610
340100101B DBM 25S NMB 1AON	C115371-5611
340100101B DCM 37P NMB 1AON	C115371-5620
340100101B DCM 37S NMB 1AON	C115371-5621
340100101B DDM 50P NMB 1AON	C115371-5632
340100101B DDM 50S NMB 1AON	C115371-5633
340100101B DEM 9P NMB 1BON	C115371-5750
340100101B DEM 9S NMB 1BON	C115371-5751
340100101B DAM 15P NMB 1BON	C115371-5754
340100101B DAM 15S NMB 1BON	C115371-5755
340100101B DBM 25P NMB 1BON	C115371-5760
340100101B DBM 25S NMB 1BON	C115371-5761
340100101B DCM 37P NMB 1BON	C115371-5770
340100101B DCM 37S NMB 1BON	C115371-5771
340100101B DDM 50P NMB 1BON	C115371-5782
340100101B DDM 50S NMB 1BON	C115371-5783
340100101B DEM 9P NMB 2AON	C115371-5900
340100101B DEM 9S NMB 2AON	C115371-5901
340100101B DAM 15P NMB 2AON	C115371-5904
340100101B DAM 15S NMB 2AON	C115371-5905
340100101B DBM 25P NMB 2AON	C115371-5910
340100101B DBM 25S NMB 2AON	C115371-5911
340100101B DCM 37P NMB 2AON	C115371-5920
340100101B DCM 37S NMB 2AON	C115371-5921
340100101B DDM 50P NMB 2AON	C115371-5932
340100101B DDM 50S NMB 2AON	C115371-5933
340100101B DEM 9P NMB 2BON	C115371-6050
340100101B DEM 9S NMB 2BON	C115371-6051
340100101B DAM 15P NMB 2BON	C115371-6054
340100101B DAM 15S NMB 2BON	C115371-6055
340100101B DBM 25P NMB 2BON	C115371-6060
340100101B DBM 25S NMB 2BON	C115371-6061
340100101B DCM 37P NMB 2BON	C115371-6070
340100101B DCM 37S NMB 2BON	C115371-6071
340100101B DDM 50P NMB 2BON	C115371-6082
340100101B DDM 50S NMB 2BON	C115371-6083

Description FR022	Part Number
DEM 9P NMB 1AON-FR022	C115371-3600
DEM 9S NMB 1AON-FR022	C115371-3601
DAM 15P NMB 1AON-FR022	C115371-3604
DAM 15S NMB 1AON-FR022	C115371-3605
DBM 25P NMB 1AON-FR022	C115371-3610
DBM 25S NMB 1AON-FR022	C115371-3611
DCM 37P NMB 1AON-FR022	C115371-3620
DCM 37S NMB 1AON-FR022	C115371-3621
DDM 50P NMB 1AON-FR022	C115371-3632
DDM 50S NMB 1AON-FR022	C115371-3633
DEM 9P NMB 1BON-FR022	C115371-3750
DEM 9S NMB 1BON-FR022	C115371-3751
DAM 15P NMB 1BON-FR022	C115371-3754
DAM 15S NMB 1BON-FR022	C115371-3755
DBM 25P NMB 1BON-FR022	C115371-3760
DBM 25S NMB 1BON-FR022	C115371-3761
DCM 37P NMB 1BON-FR022	C115371-3770
DCM 37S NMB 1BON-FR022	C115371-3771
DDM 50P NMB 1BON-FR022	C115371-3782
DDM 50S NMB 1BON-FR022	C115371-3783
DEM 9P NMB 2AON-FR022	C115371-3900
DEM 9S NMB 2AON-FR022	C115371-3901
DAM 15P NMB 2AON-FR022	C115371-3904
DAM 15S NMB 2AON-FR022	C115371-3905
DBM 25P NMB 2AON-FR022	C115371-3910
DBM 25S NMB 2AON-FR022	C115371-3911
DCM 37P NMB 2AON-FR022	C115371-3920
DCM 37S NMB 2AON-FR022	C115371-3921
DDM 50P NMB 2AON-FR022	C115371-3932
DDM 50S NMB 2AON-FR022	C115371-3933
DEM 9P NMB 2BON-FR022	C115371-4050
DEM 9S NMB 2BON-FR022	C115371-4051
DAM 15P NMB 2BON-FR022	C115371-4054
DAM 15S NMB 2BON-FR022	C115371-4055
DBM 25P NMB 2BON-FR022	C115371-4060
DBM 25S NMB 2BON-FR022	C115371-4061
DCM 37P NMB 2BON-FR022	C115371-4070
DCM 37S NMB 2BON-FR022	C115371-4071
DDM 50P NMB 2BON-FR022	C115371-4082
DDM 50S NMB 2BON-FR022	C115371-4083



Dimensions are shown in mm (inch)  
Dimensions subject to change

# 3401-001 D\*M Standard Density

## Option Y

Description ESA/ESCC		Part Number
340100101B	DEMY 9P NMB 1AON	C115371-5650
340100101B	DEMY 9S NMB 1AON	C115371-5651
340100101B	DAMY 15P NMB 1AON	C115371-5654
340100101B	DAMY 15S NMB 1AON	C115371-5655
340100101B	DBMY 25P NMB 1AON	C115371-5660
340100101B	DBMY 25S NMB 1AON	C115371-5661
340100101B	DCMY 37P NMB 1AON	C115371-5670
340100101B	DCMY 37S NMB 1AON	C115371-5671
340100101B	DDMY 50P NMB 1AON	C115371-5682
340100101B	DDMY 50S NMB 1AON	C115371-5683
340100101B	DEMY 9P NMB 1BON	C115371-5800
340100101B	DEMY 9S NMB 1BON	C115371-5801
340100101B	DAMY 15P NMB 1BON	C115371-5804
340100101B	DAMY 15S NMB 1BON	C115371-5805
340100101B	DBMY 25P NMB 1BON	C115371-5810
340100101B	DBMY 25S NMB 1BON	C115371-5811
340100101B	DCMY 37P NMB 1BON	C115371-5820
340100101B	DCMY 37S NMB 1BON	C115371-5821
340100101B	DDMY 50P NMB 1BON	C115371-5832
340100101B	DDMY 50S NMB 1BON	C115371-5833
340100101B	DEMY 9P NMB 2AON	C115371-5950
340100101B	DEMY 9S NMB 2AON	C115371-5951
340100101B	DAMY 15P NMB 2AON	C115371-5954
340100101B	DAMY 15S NMB 2AON	C115371-5955
340100101B	DBMY 25P NMB 2AON	C115371-5960
340100101B	DBMY 25S NMB 2AON	C115371-5961
340100101B	DCMY 37P NMB 2AON	C115371-5970
340100101B	DCMY 37S NMB 2AON	C115371-5971
340100101B	DDMY 50P NMB 2AON	C115371-5982
340100101B	DDMY 50S NMB 2AON	C115371-5983
340100101B	DEMY 9P NMB 2BON	C115371-6100
340100101B	DEMY 9S NMB 2BON	C115371-6101
340100101B	DAMY 15P NMB 2BON	C115371-6104
340100101B	DAMY 15S NMB 2BON	C115371-6105
340100101B	DBMY 25P NMB 2BON	C115371-6110
340100101B	DBMY 25S NMB 2BON	C115371-6111
340100101B	DCMY 37P NMB 2BON	C115371-6120
340100101B	DCMY 37S NMB 2BON	C115371-6121
340100101B	DDMY 50P NMB 2BON	C115371-6132
340100101B	DDMY 50S NMB 2BON	C115371-6133

Description FR022		Part Number
DEMY 9P NMB 1AON-FR022		C115371-3650
DEMY 9S NMB 1AON-FR022		C115371-3651
DAMY 15P NMB 1AON-FR022		C115371-3654
DAMY 15S NMB 1AON-FR022		C115371-3655
DBMY 25P NMB 1AON-FR022		C115371-3660
DBMY 25S NMB 1AON-FR022		C115371-3661
DCMY 37P NMB 1AON-FR022		C115371-3670
DCMY 37S NMB 1AON-FR022		C115371-3671
DDMY 50P NMB 1AON-FR022		C115371-3682
DDMY 50S NMB 1AON-FR022		C115371-3683
DEMY 9P NMB 1BON-FR022		C115371-3800
DEMY 9S NMB 1BON-FR022		C115371-3801
DAMY 15P NMB 1BON-FR022		C115371-3804
DAMY 15S NMB 1BON-FR022		C115371-3805
DBMY 25P NMB 1BON-FR022		C115371-3810
DBMY 25S NMB 1BON-FR022		C115371-3811
DCMY 37P NMB 1BON-FR022		C115371-3820
DCMY 37S NMB 1BON-FR022		C115371-3821
DDMY 50P NMB 1BON-FR022		C115371-3832
DDMY 50S NMB 1BON-FR022		C115371-3833
DEMY 9P NMB 2AON-FR022		C115371-3950
DEMY 9S NMB 2AON-FR022		C115371-3951
DAMY 15P NMB 2AON-FR022		C115371-3954
DAMY 15S NMB 2AON-FR022		C115371-3955
DBMY 25P NMB 2AON-FR022		C115371-3960
DBMY 25S NMB 2AON-FR022		C115371-3961
DCMY 37P NMB 2AON-FR022		C115371-3970
DCMY 37S NMB 2AON-FR022		C115371-3971
DDMY 50P NMB 2AON-FR022		C115371-3982
DDMY 50S NMB 2AON-FR022		C115371-3983
DEMY 9P NMB 2BON-FR022		C115371-4100
DEMY 9S NMB 2BON-FR022		C115371-4101
DAMY 15P NMB 2BON-FR022		C115371-4104
DAMY 15S NMB 2BON-FR022		C115371-4105
DBMY 25P NMB 2BON-FR022		C115371-4110
DBMY 25S NMB 2BON-FR022		C115371-4111
DCMY 37P NMB 2BON-FR022		C115371-4120
DCMY 37S NMB 2BON-FR022		C115371-4121
DDMY 50P NMB 2BON-FR022		C115371-4132
DDMY 50S NMB 2BON-FR022		C115371-4133



Dimensions are shown in mm (inch)  
Dimensions subject to change

# 3401-001 D\*M Standard Density

## Option E

Description ESA/ESCC		Part Number
340100101B	DEME 9P NMB 1AON	C115371-5700
340100101B	DEME 9S NMB 1AON	C115371-5701
340100101B	DAME 15P NMB 1AON	C115371-5704
340100101B	DAME 15S NMB 1AON	C115371-5705
340100101B	DBME 25P NMB 1AON	C115371-5710
340100101B	DBME 25S NMB 1AON	C115371-5711
340100101B	DCME 37P NMB 1AON	C115371-5720
340100101B	DCME 37S NMB 1AON	C115371-5721
340100101B	DDME 50P NMB 1AON	C115371-5732
340100101B	DDME 50S NMB 1AON	C115371-5733
340100101B	DEME 9P NMB 1BON	C115371-5850
340100101B	DEME 9S NMB 1BON	C115371-5851
340100101B	DAME 15P NMB 1BON	C115371-5854
340100101B	DAME 15S NMB 1BON	C115371-5855
340100101B	DBME 25P NMB 1BON	C115371-5860
340100101B	DBME 25S NMB 1BON	C115371-5861
340100101B	DCME 37P NMB 1BON	C115371-5870
340100101B	DCME 37S NMB 1BON	C115371-5871
340100101B	DDME 50P NMB 1BON	C115371-5882
340100101B	DDME 50S NMB 1BON	C115371-5883
340100101B	DEME 9P NMB 2AON	C115371-6000
340100101B	DEME 9S NMB 2AON	C115371-6001
340100101B	DAME 15P NMB 2AON	C115371-6004
340100101B	DAME 15S NMB 2AON	C115371-6005
340100101B	DBME 25P NMB 2AON	C115371-6010
340100101B	DBME 25S NMB 2AON	C115371-6011
340100101B	DCME 37P NMB 2AON	C115371-6020
340100101B	DCME 37S NMB 2AON	C115371-6021
340100101B	DDME 50P NMB 2AON	C115371-6032
340100101B	DDME 50S NMB 2AON	C115371-6033
340100101B	DEME 9P NMB 2BON	C115371-6150
340100101B	DEME 9S NMB 2BON	C115371-6151
340100101B	DAME 15P NMB 2BON	C115371-6154
340100101B	DAME 15S NMB 2BON	C115371-6155
340100101B	DBME 25P NMB 2BON	C115371-6160
340100101B	DBME 25S NMB 2BON	C115371-6161
340100101B	DCME 37P NMB 2BON	C115371-6170
340100101B	DCME 37S NMB 2BON	C115371-6171
340100101B	DDME 50P NMB 2BON	C115371-6182
340100101B	DDME 50S NMB 2BON	C115371-6183

Description FR022		Part Number
DEME 9P NMB 1AON-FR022		C115371-3700
DEME 9S NMB 1AON-FR022		C115371-3701
DAME 15P NMB 1AON-FR022		C115371-3704
DAME 15S NMB 1AON-FR022		C115371-3705
DBME 25P NMB 1AON-FR022		C115371-3710
DBME 25S NMB 1AON-FR022		C115371-3711
DCME 37P NMB 1AON-FR022		C115371-3720
DCME 37S NMB 1AON-FR022		C115371-3721
DDME 50P NMB 1AON-FR022		C115371-3732
DDME 50S NMB 1AON-FR022		C115371-3733
DEME 9P NMB 1BON-FR022		C115371-3850
DEME 9S NMB 1BON-FR022		C115371-3851
DAME 15P NMB 1BON-FR022		C115371-3854
DAME 15S NMB 1BON-FR022		C115371-3855
DBME 25P NMB 1BON-FR022		C115371-3860
DBME 25S NMB 1BON-FR022		C115371-3861
DCME 37P NMB 1BON-FR022		C115371-3870
DCME 37S NMB 1BON-FR022		C115371-3871
DDME 50P NMB 1BON-FR022		C115371-3882
DDME 50S NMB 1BON-FR022		C115371-3883
DEME 9P NMB 2AON-FR022		C115371-4000
DEME 9S NMB 2AON-FR022		C115371-4001
DAME 15P NMB 2AON-FR022		C115371-4004
DAME 15S NMB 2AON-FR022		C115371-4005
DBME 25P NMB 2AON-FR022		C115371-4010
DBME 25S NMB 2AON-FR022		C115371-4011
DCME 37P NMB 2AON-FR022		C115371-4020
DCME 37S NMB 2AON-FR022		C115371-4021
DDME 50P NMB 2AON-FR022		C115371-4032
DDME 50S NMB 2AON-FR022		C115371-4033
DEME 9P NMB 2BON-FR022		C115371-4150
DEME 9S NMB 2BON-FR022		C115371-4151
DAME 15P NMB 2BON-FR022		C115371-4154
DAME 15S NMB 2BON-FR022		C115371-4155
DBME 25P NMB 2BON-FR022		C115371-4160
DBME 25S NMB 2BON-FR022		C115371-4161
DCME 37P NMB 2BON-FR022		C115371-4170
DCME 37S NMB 2BON-FR022		C115371-4171
DDME 50P NMB 2BON-FR022		C115371-4182
DDME 50S NMB 2BON-FR022		C115371-4183



Dimensions are shown in mm (inch)  
Dimensions subject to change

# 3401-001 D\*M Standard Density

90° Bent PCB solder Terminations / With Brackets / European Footprint Type 1A7N – 1A9N – 1B7N – 1B9N – 2A7N – 2A9N – 2B7N – 2B9N

## Specific Dimensions

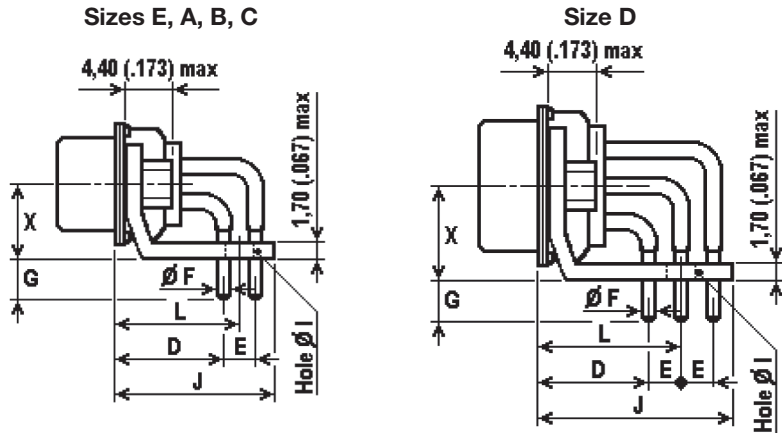

Termination Modifier	ØF ± 0,05 (.002)	E Typical
1A7N / 1A9N	0,60 (.024)	2,54 (.100)
1B7N / 1B9N	0,60 (.024)	2,84 (.112)
2A7N / 2A9N	0,76 (.030)	2,54 (.100)
2B7N / 2B9N	0,76 (.030)	2,84 (.112)

2 pieces metal brackets:

«7N»: fixed with captive nuts 4-40 UNC-2B

«9N»: fixed with captive nuts M3

Hole Ø I: 3,22 (.127) ± 0,10 (.004)

Bracket width (onto PCB):

Shell sizes E, A, B, C: 6,10 (.240) max

Shell size D: 5,50 (.217) max

Contacts	Shell Size	D min	D max	G ± 0,40 (.016)	J max	L Typical	X ± 0,15 (.006)	Pitch between contacts
Male	E	10,10 (.398)	10,30 (.406)	4,00 (.157)	15,60 (.614)	11,52 (.454)	7,35 (.289)	2,74 (.108)
	A	10,10 (.398)	10,30 (.406)	4,00 (.157)	15,60 (.614)	11,52 (.454)	7,35 (.289)	2,74 (.108)
	B	10,30 (.406)	10,50 (.413)	4,00 (.157)	15,80 (.622)	11,74 (.462)	7,35 (.289)	2,76 (.109)
	C	10,30 (.406)	10,50 (.413)	4,00 (.157)	15,80 (.622)	11,74 (.462)	7,35 (.289)	2,76 (.109)
	D	10,30 (.406)	10,50 (.413)	4,00 (.157)	17,70 (.697)	13,16 (.518)	8,70 (.343)	2,76 (.109)
Female	E	10,10 (.398)	10,30 (.406)	4,00 (.157)	15,60 (.614)	11,52 (.454)	7,35 (.289)	2,74 (.108)
	A	10,10 (.398)	10,30 (.406)	4,00 (.157)	15,60 (.614)	11,52 (.454)	7,35 (.289)	2,74 (.108)
	B	10,10 (.398)	10,30 (.406)	4,00 (.157)	15,60 (.614)	11,52 (.454)	7,35 (.289)	2,76 (.109)
	C	10,10 (.398)	10,30 (.406)	4,00 (.157)	15,60 (.614)	11,52 (.454)	7,35 (.289)	2,76 (.109)
	D	10,10 (.398)	10,30 (.406)	4,00 (.157)	17,50 (.689)	12,94 (.509)	8,70 (.343)	2,76 (.109)

Termination Modifier: 1A7N, 1B7N, 1A9N, 1B9N, 2A7N, 2B7N, 2A9N, 2B9N

For other termination modifier, consult factory

## Weights

	Shell Size	Male Contact	Female Contact
<b>Max Weight (grams) per contact</b>		0,24 / 0,28 / 0,32	0,29 / 0,34 / 0,37
<b>Max Weight (grams) of all contacts per size</b>	E	2,36	2,86
	A	3,92	4,75
	B	6,52	7,90
	C	9,64	11,68
	D	14,00	16,66
<b>Max Weight (grams) of Brackets &amp; Nuts</b>	Sizes E, A, B, C	3,10	3,10
	Size D	3,80	3,80

# 3401-001 D\*M Standard Density

## Cross references

90° bent PCB (with brackets)

### Standard

Description ESA/ESCC	Part Number
340100101B DEM 9P NMB 1A7N	C115371-6200
340100101B DEM 9S NMB 1A7N	C115371-6201
340100101B DAM 15P NMB 1A7N	C115371-6204
340100101B DAM 15S NMB 1A7N	C115371-6205
340100101B DBM 25P NMB 1A7N	C115371-6210
340100101B DBM 25S NMB 1A7N	C115371-6211
340100101B DCM 37P NMB 1A7N	C115371-6220
340100101B DCM 37S NMB 1A7N	C115371-6221
340100101B DDM 50P NMB 1A7N	C115371-6232
340100101B DDM 50S NMB 1A7N	C115371-6233
340100101B DEM 9P NMB 1B7N	C115371-6250
340100101B DEM 9S NMB 1B7N	C115371-6251
340100101B DAM 15P NMB 1B7N	C115371-6254
340100101B DAM 15S NMB 1B7N	C115371-6255
340100101B DBM 25P NMB 1B7N	C115371-6260
340100101B DBM 25S NMB 1B7N	C115371-6261
340100101B DCM 37P NMB 1B7N	C115371-6270
340100101B DCM 37S NMB 1B7N	C115371-6271
340100101B DDM 50P NMB 1B7N	C115371-6282
340100101B DDM 50S NMB 1B7N	C115371-6283
340100101B DEM 9P NMB 1A9N	C115371-6300
340100101B DEM 9S NMB 1A9N	C115371-6301
340100101B DAM 15P NMB 1A9N	C115371-6304
340100101B DAM 15S NMB 1A9N	C115371-6305
340100101B DBM 25P NMB 1A9N	C115371-6310
340100101B DBM 25S NMB 1A9N	C115371-6311
340100101B DCM 37P NMB 1A9N	C115371-6320
340100101B DCM 37S NMB 1A9N	C115371-6321
340100101B DDM 50P NMB 1A9N	C115371-6332
340100101B DDM 50S NMB 1A9N	C115371-6333
340100101B DEM 9P NMB 1B9N	C115371-6350
340100101B DEM 9S NMB 1B9N	C115371-6351
340100101B DAM 15P NMB 1B9N	C115371-6354
340100101B DAM 15S NMB 1B9N	C115371-6355
340100101B DBM 25P NMB 1B9N	C115371-6360
340100101B DBM 25S NMB 1B9N	C115371-6361
340100101B DCM 37P NMB 1B9N	C115371-6370
340100101B DCM 37S NMB 1B9N	C115371-6371
340100101B DDM 50P NMB 1B9N	C115371-6382
340100101B DDM 50S NMB 1B9N	C115371-6383
340100101B DEM 9P NMB 2A7N	C115371-6400
340100101B DEM 9S NMB 2A7N	C115371-6401
340100101B DAM 15P NMB 2A7N	C115371-6404
340100101B DAM 15S NMB 2A7N	C115371-6405
340100101B DBM 25P NMB 2A7N	C115371-6410
340100101B DBM 25S NMB 2A7N	C115371-6411
340100101B DCM 37P NMB 2A7N	C115371-6420

Description FR022	Part Number
DEM 9P NMB 1A7N-FR022	C115371-4200
DEM 9S NMB 1A7N-FR022	C115371-4201
DAM 15P NMB 1A7N-FR022	C115371-4204
DAM 15S NMB 1A7N-FR022	C115371-4205
DBM 25P NMB 1A7N-FR022	C115371-4210
DBM 25S NMB 1A7N-FR022	C115371-4211
DCM 37P NMB 1A7N-FR022	C115371-4220
DCM 37S NMB 1A7N-FR022	C115371-4221
DDM 50P NMB 1A7N-FR022	C115371-4232
DDM 50S NMB 1A7N-FR022	C115371-4233
DEM 9P NMB 1B7N-FR022	C115371-4250
DEM 9S NMB 1B7N-FR022	C115371-4251
DAM 15P NMB 1B7N-FR022	C115371-4254
DAM 15S NMB 1B7N-FR022	C115371-4255
DBM 25P NMB 1B7N-FR022	C115371-4260
DBM 25S NMB 1B7N-FR022	C115371-4261
DCM 37P NMB 1B7N-FR022	C115371-4270
DCM 37S NMB 1B7N-FR022	C115371-4271
DDM 50P NMB 1B7N-FR022	C115371-4282
DDM 50S NMB 1B7N-FR022	C115371-4283
DEM 9P NMB 1A9N-FR022	C115371-4300
DEM 9S NMB 1A9N-FR022	C115371-4301
DAM 15P NMB 1A9N-FR022	C115371-4304
DAM 15S NMB 1A9N-FR022	C115371-4305
DBM 25P NMB 1A9N-FR022	C115371-4310
DBM 25S NMB 1A9N-FR022	C115371-4311
DCM 37P NMB 1A9N-FR022	C115371-4320
DCM 37S NMB 1A9N-FR022	C115371-4321
DDM 50P NMB 1A9N-FR022	C115371-4332
DDM 50S NMB 1A9N-FR022	C115371-4333
DEM 9P NMB 1B9N-FR022	C115371-4350
DEM 9S NMB 1B9N-FR022	C115371-4351
DAM 15P NMB 1B9N-FR022	C115371-4354
DAM 15S NMB 1B9N-FR022	C115371-4355
DBM 25P NMB 1B9N-FR022	C115371-4360
DBM 25S NMB 1B9N-FR022	C115371-4361
DCM 37P NMB 1B9N-FR022	C115371-4370
DCM 37S NMB 1B9N-FR022	C115371-4371
DDM 50P NMB 1B9N-FR022	C115371-4382
DDM 50S NMB 1B9N-FR022	C115371-4383
DEM 9P NMB 2A7N-FR022	C115371-4400
DEM 9S NMB 2A7N-FR022	C115371-4401
DAM 15P NMB 2A7N-FR022	C115371-4404
DAM 15S NMB 2A7N-FR022	C115371-4405
DBM 25P NMB 2A7N-FR022	C115371-4410
DBM 25S NMB 2A7N-FR022	C115371-4411
DCM 37P NMB 2A7N-FR022	C115371-4420



Dimensions are shown in mm (inch)  
Dimensions subject to change



## 3401-001 D\*M Standard Density

Description ESA/ESCC		Part Number
340100101B	DCM 37S NMB 2A7N	C115371-6421
340100101B	DDM 50P NMB 2A7N	C115371-6432
340100101B	DDM 50S NMB 2A7N	C115371-6433
340100101B	DEM 9P NMB 2B7N	C115371-6450
340100101B	DEM 9S NMB 2B7N	C115371-6451
340100101B	DAM 15P NMB 2B7N	C115371-6454
340100101B	DAM 15S NMB 2B7N	C115371-6455
340100101B	DBM 25P NMB 2B7N	C115371-6460
340100101B	DBM 25S NMB 2B7N	C115371-6461
340100101B	DCM 37P NMB 2B7N	C115371-6470
340100101B	DCM 37S NMB 2B7N	C115371-6471
340100101B	DDM 50P NMB 2B7N	C115371-6482
340100101B	DDM 50S NMB 2B7N	C115371-6483
340100101B	DEM 9P NMB 2A9N	C115371-6500
340100101B	DEM 9S NMB 2A9N	C115371-6501
340100101B	DAM 15P NMB 2A9N	C115371-6504
340100101B	DAM 15S NMB 2A9N	C115371-6505
340100101B	DBM 25P NMB 2A9N	C115371-6510
340100101B	DBM 25S NMB 2A9N	C115371-6511
340100101B	DCM 37P NMB 2A9N	C115371-6520
340100101B	DCM 37S NMB 2A9N	C115371-6521
340100101B	DDM 50P NMB 2A9N	C115371-6532
340100101B	DDM 50S NMB 2A9N	C115371-6533
340100101B	DEM 9P NMB 2B9N	C115371-6550
340100101B	DEM 9S NMB 2B9N	C115371-6551
340100101B	DAM 15P NMB 2B9N	C115371-6554
340100101B	DAM 15S NMB 2B9N	C115371-6555
340100101B	DBM 25P NMB 2B9N	C115371-6560
340100101B	DBM 25S NMB 2B9N	C115371-6561
340100101B	DCM 37P NMB 2B9N	C115371-6570
340100101B	DCM 37S NMB 2B9N	C115371-6571
340100101B	DDM 50P NMB 2B9N	C115371-6582
340100101B	DDM 50S NMB 2B9N	C115371-6583

Description FR022		Part Number
DCM 37S NMB 2A7N-FR022		C115371-4421
DDM 50P NMB 2A7N-FR022		C115371-4432
DDM 50S NMB 2A7N-FR022		C115371-4433
DEM 9P NMB 2B7N-FR022		C115371-4450
DEM 9S NMB 2B7N-FR022		C115371-4451
DAM 15P NMB 2B7N-FR022		C115371-4454
DAM 15S NMB 2B7N-FR022		C115371-4455
DBM 25P NMB 2B7N-FR022		C115371-4460
DBM 25S NMB 2B7N-FR022		C115371-4461
DCM 37P NMB 2B7N-FR022		C115371-4470
DCM 37S NMB 2B7N-FR022		C115371-4471
DDM 50P NMB 2B7N-FR022		C115371-4482
DDM 50S NMB 2B7N-FR022		C115371-4483
DEM 9P NMB 2A9N-FR022		C115371-4500
DEM 9S NMB 2A9N-FR022		C115371-4501
DAM 15P NMB 2A9N-FR022		C115371-4504
DAM 15S NMB 2A9N-FR022		C115371-4505
DBM 25P NMB 2A9N-FR022		C115371-4510
DBM 25S NMB 2A9N-FR022		C115371-4511
DCM 37P NMB 2A9N-FR022		C115371-4520
DCM 37S NMB 2A9N-FR022		C115371-4521
DDM 50P NMB 2A9N-FR022		C115371-4532
DDM 50S NMB 2A9N-FR022		C115371-4533
DEM 9P NMB 2B9N-FR022		C115371-4550
DEM 9S NMB 2B9N-FR022		C115371-4551
DAM 15P NMB 2B9N-FR022		C115371-4554
DAM 15S NMB 2B9N-FR022		C115371-4555
DBM 25P NMB 2B9N-FR022		C115371-4560
DBM 25S NMB 2B9N-FR022		C115371-4561
DCM 37P NMB 2B9N-FR022		C115371-4570
DCM 37S NMB 2B9N-FR022		C115371-4571
DDM 50P NMB 2B9N-FR022		C115371-4582
DDM 50S NMB 2B9N-FR022		C115371-4583



*Dimensions are shown in mm (inch)  
Dimensions subject to change*

# 3401-001 D\*M Standard Density

90° Bent PCB solder Terminations / With Monoblock Plastic Brackets / U.S. Footprint type D and L

## Specific Dimensions

Sizes E, A, B, C

Size D

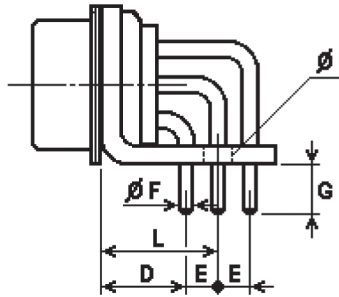
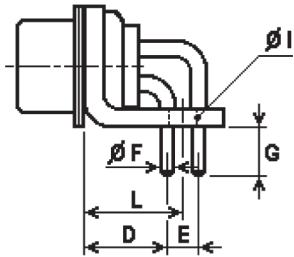

Termination Modifier	ØF ± 0,05 (.002)	G ± 0,37 (.015)
D	0,76 (.030)	3,21 (.126)
L	0,76 (.030)	4,33 (.170)

1 piece plastic bracket  
Hole Ø I: 3,05 (.120) ± 0,13 (.005)

Contacts	Shell Size	D min	D max	E Typical	L ± 0,25 (.010)	Pitch between contacts
Male	E	6,94 (.273)	7,44 (.293)	2,84 (.112)	8,60 (.339)	2,74 (.108)
	A	6,94 (.273)	7,44 (.293)	2,84 (.112)	8,60 (.339)	2,74 (.108)
	B	6,94 (.273)	7,44 (.293)	2,84 (.112)	8,60 (.339)	2,76 (.109)
	C	6,94 (.273)	7,44 (.293)	2,84 (.112)	8,60 (.339)	2,76 (.109)
Female	D	6,94 (.273)	7,44 (.293)	2,84 (.112)	10.02 (.394)	2,76 (.109)
	E	6,94 (.273)	7,44 (.293)	2,84 (.112)	8,60 (.339)	2,74 (.108)
	A	6,94 (.273)	7,44 (.293)	2,84 (.112)	8,60 (.339)	2,74 (.108)
	B	6,94 (.273)	7,44 (.293)	2,84 (.112)	8,60 (.339)	2,76 (.109)
	C	6,94 (.273)	7,44 (.293)	2,84 (.112)	8,60 (.339)	2,76 (.109)
	D	6,94 (.273)	7,44 (.293)	2,84 (.112)	10.02 (.394)	2,76 (.109)

Termination Modifier: D, L

For other termination modifier, consult factory

## Weights

	Shell Size	Male Contact	Female Contact	Plastic Bracket
<b>Max Weight (grams) per contact</b>		0,22 / 0,96 / 0,30	0,27 / 0,32 / 0,35	
<b>Max Weight (grams) of all contacts per size</b>	E	2,18	2,68	1,49
	A	3,62	4,45	1,72
	B	6,02	7,40	2,05
	C	8,90	10,94	2,41
	D	13,00	15,66	3,22

# 3401-001 D\*M Standard Density

## 90° Bent PCB solder Terminations / With Brackets / US Footprint Type L7 – L9

### Specific Dimensions

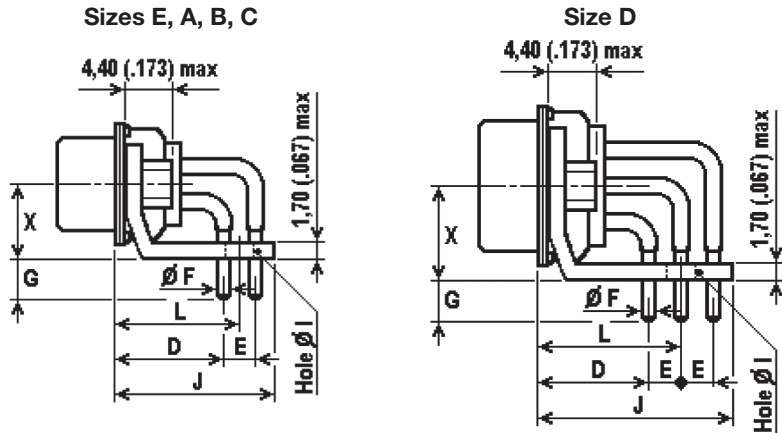

Termination Modifier	ØF ± 0,05 (.002)	E Typical
L7	0,76 (.030)	2,84 (.112)
L9	0,76 (.030)	2,84 (.112)

2 pieces metal brackets:

“L7”: fixed with captive nuts 4-40 UNC-2B

“L9”: fixed with captive nuts M3

Hole Ø I: 3,22 (.127) ± 0,10 (.004)

Bracket width (onto PCB):

Shell sizes E, A, B, C, D: 5,70 (.224) max

Contacts	Shell Size	D min	D max	G ± 0.37 (.015)	J max	L Typical	X ± 0,15 (.006)	Pitch between contacts
Male	E	6,94 (.273)	7,44 (.293)	4,33 (.170)	11,80 (.464)	8,60 (.339)	6,35 (.250)	2,74 (.108)
	A	6,94 (.273)	7,44 (.293)	4,33 (.170)	11,80 (.464)	8,60 (.339)	6,35 (.250)	2,74 (.108)
	B	6,94 (.273)	7,44 (.293)	4,33 (.170)	11,80 (.464)	8,60 (.339)	6,35 (.250)	2,76 (.109)
	C	6,94 (.273)	7,44 (.293)	4,33 (.170)	11,80 (.464)	8,60 (.339)	6,35 (.250)	2,76 (.109)
	D	6,94 (.273)	7,44 (.293)	4,33 (.170)	11,80 (.464)	10,05 (.396)	7,75 (.305)	2,76 (.109)
Female	E	6,94 (.273)	7,44 (.293)	4,33 (.170)	11,80 (.464)	8,60 (.339)	6,35 (.250)	2,74 (.108)
	A	6,94 (.273)	7,44 (.293)	4,33 (.170)	11,80 (.464)	8,60 (.339)	6,35 (.250)	2,74 (.108)
	B	6,94 (.273)	7,44 (.293)	4,33 (.170)	11,80 (.464)	8,60 (.339)	6,35 (.250)	2,76 (.109)
	C	6,94 (.273)	7,44 (.293)	4,33 (.170)	11,80 (.464)	8,60 (.339)	6,35 (.250)	2,76 (.109)
	D	6,94 (.273)	7,44 (.293)	4,33 (.170)	11,80 (.464)	10,05 (.396)	7,75 (.305)	2,76 (.109)

Termination Modifier: L7 / L9

For other termination modifier, consult factory

### Weights

	Shell Size	Male Contact	Female Contact
<b>Max Weight (grams) per contact</b>		0,24 / 0,28 / 0,32	0,29 / 0,34 / 0,37
<b>Max Weight (grams) of all contacts per size</b>	E	2,36	2,86
	A	3,92	4,75
	B	6,52	7,90
	C	9,64	11,68
	D	14,00	16,66
<b>Max Weight (grams) of Brackets &amp; Nuts</b>	E, A, B, C	3,00	3,00
	D	3,60	3,60

# 3401-001 D\*M Standard Density

## Cross references

90° bent PCB (with brackets)

## Standard

### L7

Description ESA/ESCC		Part Number	Description FR022		Part Number
340100101B	DEM 9P NMB L7	C115331-9142	DEM 9P NMBL7-FR022	C115371-0126	
340100101B	DEM 9S NMB L7	C115331-9143	DEM 9S NMBL7-FR022	C115371-0127	
340100101B	DAM 15P NMB L7	C115371-9146	DAM 15P NMBL7-FR022	C115371-0130	
340100101B	DAM 15S NMB L7	C115371-9147	DAM 15S NMBL7-FR022	C115371-0131	
340100101B	DBM 25P NMB L7	C115371-9156	DBM 25P NMBL7-FR022	C115371-0140	
340100101B	DBM 25S NMB L7	C115371-9157	DBM 25S NMBL7-FR022	C115371-0141	
340100101B	DCM 37P NMB L7	C115371-9168	DCM 37P NMBL7-FR022	C115371-0152	
340100101B	DCM 37S NMB L7	C115371-9169	DCM 37S NMBL7-FR022	C115371-0153	
340100101B	DDM 50P NMB L7	C115371-9182	DDM 50P NMBL7-FR022	C115371-0166	
340100101B	DDM 50S NMB L7	C115371-9183	DDM 50S NMBL7-FR022	C115371-0167	

### L9

Description ESA/ESCC		Part Number	Description FR022		Part Number
340100101B	DEM 9P NMB L9	C115331-9192	DEM 9P NMBL9-FR022	C115371-0176	
340100101B	DEM 9S NMB L9	C115331-9193	DEM 9S NMBL9-FR022	C115371-0177	
340100101B	DAM 15P NMB L9	C115371-9196	DAM 15P NMBL9-FR022	C115371-0180	
340100101B	DAM 15S NMB L9	C115371-9197	DAM 15S NMBL9-FR022	C115371-0181	
340100101B	DBM 25P NMB L9	C115371-9206	DBM 25P NMBL9-FR022	C115371-0190	
340100101B	DBM 25S NMB L9	C115371-9207	DBM 25S NMBL9-FR022	C115371-0191	
340100101B	DCM 37P NMB L9	C115371-9218	DCM 37P NMBL9-FR022	C115371-0202	
340100101B	DCM 37S NMB L9	C115371-9219	DCM 37S NMBL9-FR022	C115371-0203	
340100101B	DDM 50P NMB L9	C115371-9232	DDM 50P NMBL9-FR022	C115371-0216	
340100101B	DDM 50S NMB L9	C115371-9233	DDM 50S NMBL9-FR022	C115371-0217	

# 3401-001 D\*M Standard Density

## Wire-Wrap Terminations type F179A.

### Specific Dimensions

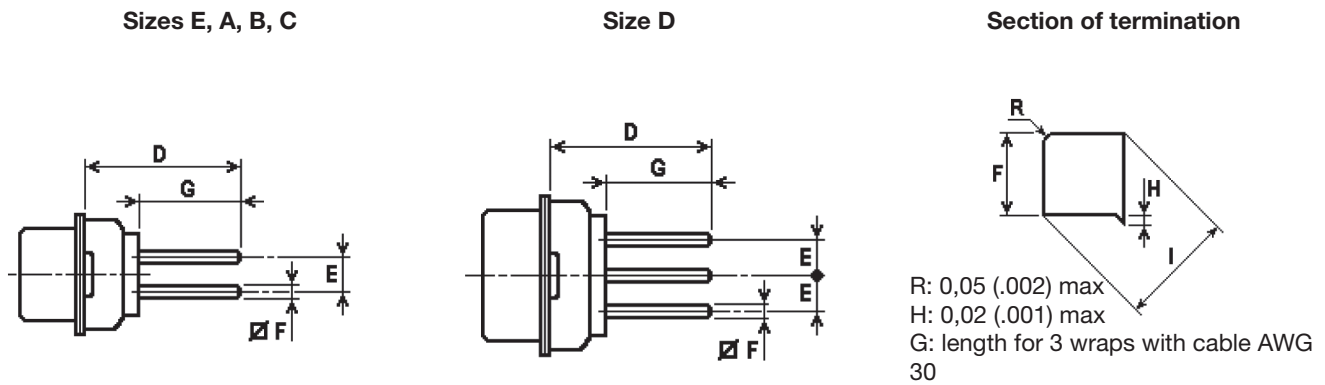

Contacts	Shell Size	D max	G ± 0,10 (.004)	E Typical	F ± 0,01 (.0004)	I ± 0,038 (.0015)	Pitch between contacts
Male	E	20,10 (.791)	12,70 (.500)	2,84 (.112)	0,60 (.024)	0,826 (.0325)	2,74 (.108)
	A	20,10 (.791)	12,70 (.500)	2,84 (.112)	0,60 (.024)	0,826 (.0325)	2,74 (.108)
	B	20,30 (.799)	12,70 (.500)	2,84 (.112)	0,60 (.024)	0,826 (.0325)	2,76 (.109)
	C	20,30 (.799)	12,70 (.500)	2,84 (.112)	0,60 (.024)	0,826 (.0325)	2,76 (.109)
	D	20,30 (.799)	12,70 (.500)	2,84 (.112)	0,60 (.024)	0,826 (.0325)	2,76 (.109)
Female	E	20,10 (.791)	12,70 (.500)	2,84 (.112)	0,60 (.024)	0,826 (.0325)	2,74 (.108)
	A	20,10 (.791)	12,70 (.500)	2,84 (.112)	0,60 (.024)	0,826 (.0325)	2,74 (.108)
	B	20,10 (.791)	12,70 (.500)	2,84 (.112)	0,60 (.024)	0,826 (.0325)	2,76 (.109)
	C	20,10 (.791)	12,70 (.500)	2,84 (.112)	0,60 (.024)	0,826 (.0325)	2,76 (.109)
	D	20,10 (.791)	12,70 (.500)	2,84 (.112)	0,60 (.024)	0,826 (.0325)	2,76 (.109)

Termination Modifier: F179A  
For other termination modifier, consult factory

### Weights

	Shell Size	Male Contact	Female Contact
<b>Max Weight (grams) per contact</b>		0,28	0,34
<b>Max Weight (grams) of all contacts per size</b>	E	2,52	3,06
	A	4,20	5,10
	B	7,00	8,50
	C	10,36	12,58
	D	14,00	17,00

# 3401-001 D\*M Standard Density

## Cross references

Solder bucket

## Standard

Description ESA/ESCC	Part Number
340100101B DEM 9P NMB F179A	C115371-5450
340100101B DEM 9S NMB F179A	C115371-5451
340100101B DAM 15P NMB F179A	C115371-5454
340100101B DAM 15S NMB F179A	C115371-5455
340100101B DBM 25P NMB F179A	C115371-5460
340100101B DBM 25S NMB F179A	C115371-5461
340100101B DCM 37P NMB F179A	C115371-5470
340100101B DCM 37S NMB F179A	C115371-5471
340100101B DDM 50P NMB F179A	C115371-5482
340100101B DDM 50S NMB F179A	C115371-5483

Description FR022	Part Number
DEM 9P NMB F179A-FR022	C115371-3450
DEM 9S NMB F179A-FR022	C115371-3451
DAM 15P NMB F179A-FR022	C115371-3454
DAM 15S NMB F179A-FR022	C115371-3455
DBM 25P NMB F179A-FR022	C115371-3460
DBM 25S NMB F179A-FR022	C115371-3461
DCM 37P NMB F179A-FR022	C115371-3470
DCM 37S NMB F179A-FR022	C115371-3471
DDM 50P NMB F179A-FR022	C115371-3482
DDM 50S NMB F179A-FR022	C115371-3483

## Option Y

Description ESA/ESCC	Part Number
340100101B DEMY 9P NMB F179A	C115371-5500
340100101B DEMY 9S NMB F179A	C115371-5501
340100101B DAMY 15P NMB F179A	C115371-5504
340100101B DAMY 15S NMB F179A	C115371-5505
340100101B DBMY 25P NMB F179A	C115371-5510
340100101B DBMY 25S NMB F179A	C115371-5511
340100101B DCMY 37P NMB F179A	C115371-5520
340100101B DCMY 37S NMB F179A	C115371-5521
340100101B DDMY 50P NMB F179A	C115371-5532
340100101B DDMY 50S NMB F179A	C115371-5533

Description FR022	Part Number
DEMY 9P NMB F179A-FR022	C115371-3500
DEMY 9S NMB F179A-FR022	C115371-3501
DAMY 15P NMB F179A-FR022	C115371-3504
DAMY 15S NMB F179A-FR022	C115371-3505
DBMY 25P NMB F179A-FR022	C115371-3510
DBMY 25S NMB F179A-FR022	C115371-3511
DCMY 37P NMB F179A-FR022	C115371-3520
DCMY 37S NMB F179A-FR022	C115371-3521
DDMY 50P NMB F179A-FR022	C115371-3532
DDMY 50S NMB F179A-FR022	C115371-3533

## Option E

Description ESA/ESCC	Part Number
340100101B DEME 9P NMB F179A	C115371-5550
340100101B DEME 9S NMB F179A	C115371-5551
340100101B DAME 15P NMB F179A	C115371-5554
340100101B DAME 15S NMB F179A	C115371-5555
340100101B DBME 25P NMB F179A	C115371-5560
340100101B DBME 25S NMB F179A	C115371-5561
340100101B DCME 37P NMB F179A	C115371-5570
340100101B DCME 37S NMB F179A	C115371-5571
340100101B DDME 50P NMB F179A	C115371-5582
340100101B DDME 50S NMB F179A	C115371-5583

Description FR022	Part Number
DEME 9P NMB F179A-FR022	C115371-3550
DEME 9S NMB F179A-FR022	C115371-3551
DAME 15P NMB F179A-FR022	C115371-3554
DAME 15S NMB F179A-FR022	C115371-3555
DBME 25P NMB F179A-FR022	C115371-3560
DBME 25S NMB F179A-FR022	C115371-3561
DCME 37P NMB F179A-FR022	C115371-3570
DCME 37S NMB F179A-FR022	C115371-3571
DDME 50P NMB F179A-FR022	C115371-3582
DDME 50S NMB F179A-FR022	C115371-3583

# 3401-001 D\*M Standard Density

## Combination Arrangements

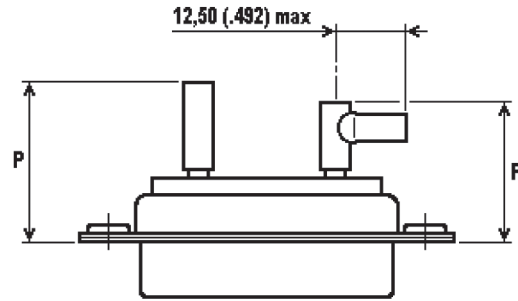
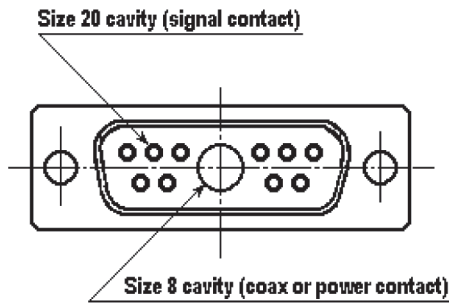

**P max (Coaxial Contacts)**

Contacts	Shell Size	Note 1	Note 2	Note 3	Note 4
Male	E	19,60 (.772)	22,30 (.878)	14,30 (.563)	14,40 (.567)
	A	19,60 (.772)	22,30 (.878)	14,30 (.563)	14,40 (.567)
	B	19,80 (.780)	22,50 (.886)	14,50 (.571)	14,60 (.575)
	C	19,80 (.780)	22,50 (.886)	14,50 (.571)	14,60 (.575)
	D	19,80 (.780)	22,50 (.886)	14,50 (.571)	14,60 (.575)
Female	E	19,60 (.772)	22,30 (.878)	14,30 (.563)	14,40 (.567)
	A	19,60 (.772)	22,30 (.878)	14,30 (.563)	14,40 (.567)
	B	19,60 (.772)	22,30 (.878)	14,30 (.563)	14,40 (.567)
	C	19,60 (.772)	22,30 (.878)	14,30 (.563)	14,40 (.567)
	D	19,60 (.772)	22,30 (.878)	14,30 (.563)	14,40 (.567)

**P max (Power Contacts)**

Note 5	Note 6	Note 7	Note 8
17,70 (.697)	19,80 (.780)	16,90 (.665)	14,60 (.575)
17,70 (.697)	19,80 (.780)	16,90 (.665)	14,60 (.575)
17,90 (.705)	20,00 (.787)	17,10 (.673)	14,80 (.583)
17,90 (.705)	20,00 (.787)	17,10 (.673)	14,80 (.583)
17,90 (.705)	20,00 (.787)	17,10 (.673)	14,80 (.583)
17,70 (.697)	19,80 (.780)	16,90 (.665)	14,60 (.575)
17,70 (.697)	19,80 (.780)	16,90 (.665)	14,60 (.575)
17,70 (.697)	19,80 (.780)	16,90 (.665)	14,60 (.575)
17,70 (.697)	19,80 (.780)	16,90 (.665)	14,60 (.575)
17,70 (.697)	19,80 (.780)	16,90 (.665)	14,60 (.575)

Note 1: ESA/ESCC 3401/004 variants 01 / 02 / 05 / 06 / 11 / 12 / 15 / 16

Note 2: ESA/ESCC 3401/004 variants 09 / 10 / 19 / 20

Note 3: ESA/ESCC 3401/004 variants 03 / 04 / 07 / 08

Note 4: ESA/ESCC 3401/004 variants 13 / 14 / 17 / 18

Note 5: ESA/ESCC 3401/040 variants 01 / 02 / 03 / 04 / 05 / 06

Note 6: ESA/ESCC 3401/040 variants 07 / 08

Note 7: ESA/ESCC 3401/040 variants 09 / 10

Note 8: ESA/ESCC 3401/040 variants 11 / 12

## Combination Arrangements

Shell Size									
E	5W1								
A	3W3		3WK3		7W2		11W1		
B	5W5		9W4		13W3		17W2	21W1	
C	8W8		13W6		17W5		21WA4	25W3	27W2
D	24W7		36W4		43W2		47W1		

# 3401-001 D\*M Standard Density

## PCB Hole Pattern

Face view, pin insert

### Size E

9 contacts

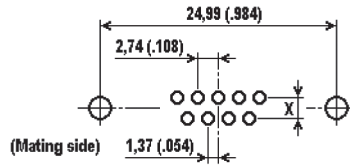

### Size A

15 contacts

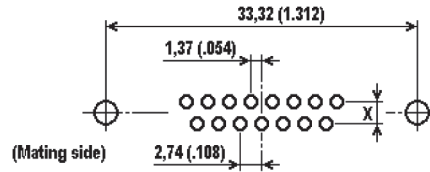

### Size B

25 contacts

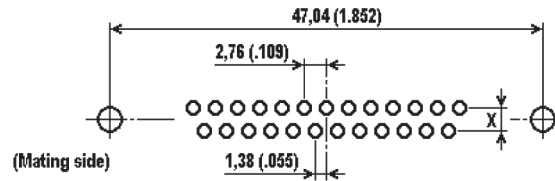

### Size C

37 contacts

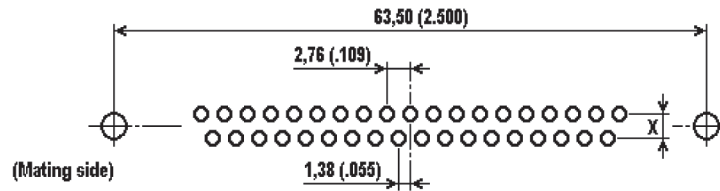

### Size D

50 contacts

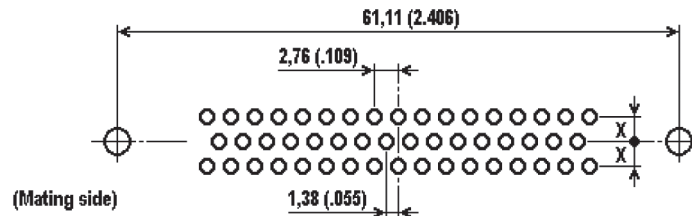

### Dimension X

- 2,54 (.100) for "90° bent PCB / European Footprint Type 1AxN and 2AxN"
- 2,84 (.112) for "Straight PCB", "90° bent PCB / European Footprint Type 1BxN and 2BxN", and "90° bent PCB / U.S. Footprint"

### Recommended PCB hole for signal contacts

- $\varnothing$  1,00 (.040) min for terminations  $\varnothing$  0,60 (.024)
- $\varnothing$  1,15 (.045) min for terminations  $\varnothing$  0,76 (.030)





*Dimensions are shown in mm (inch)  
Dimensions subject to change*



*Dimensions are shown in mm (inch)  
Dimensions subject to change*



*Dimensions are shown in mm (inch)  
Dimensions subject to change*

## X-ON Electronics

Largest Supplier of Electrical and Electronic Components

*Click to view similar products for [D-Sub Standard Connectors](#) category:*

*Click to view products by [C&K](#) manufacturer:*

Other Similar products are found below :

[56F706-005-LI](#) [56F711-015](#) [LV242999-142T12](#) [015-0341-000](#) [015-0349-000](#) [015-0350-000](#) [015-8544-011](#) [015-8755-001](#) [017041-0005](#)  
[020419-0104](#) [012-0467-000](#) [012-9507-114](#) [020745-0008](#) [609-25P](#) [609-9P](#) [M24308/2-23Z](#) [M24308/2-36Z](#) [CT0-24-10SC](#) [CT0E20-8PS](#)  
[CT0E22-14SC](#) [CT0F16S-1SC](#) [CT0FA22-1SS](#) [CT0P14S-5SXS](#) [CT0P22-14PS](#) [CT0TA16-11SXCA232](#) [CT0U22-14PSA206F127](#) [CT1E20-](#)  
[19SS](#) [CT1E20-22SCAU-G9](#) [CT1F22-14PC-G9](#) [CT1FC22-2PC](#) [CT1FC24-28SSAU](#) [CT1N22-22SS](#) [CT2-10SL-3SC](#) [CT2-14S-2PCA34](#) [CT2-](#)  
[18-10PS-FMLB-D](#) [CT2-18-11PCAU](#) [CT2-18-1PSAUA34](#) [CT2-22-19SC](#) [CT2-22-19SS-A206](#) [CT2-24-2PS](#) [CT2-28-12SC](#) [CT2-28-](#)  
[12SCA232](#) [CT2-28-12SSA232](#) [CT6-10SL-3SC](#) [CT6-10SL-4SC](#) [CT6-16-12SC](#) [CT6-18-10PSA206](#) [CT6-18-10PSA232](#) [CT6-18-](#)  
[10SSF127A206](#) [CT6-28-22SS](#)