

E020 Series Sealed Snap-acting Momentary Pushbutton Switches



A
Pushbutton

Features/Benefits

- Process sealed with disposable splashproof boot
- Long life contact design
- Snap-fitting plunger available
- RoHS compliant models available

Typical Applications

- Instrumentation
- Telecommunications and networking equipment
- Computers and peripherals

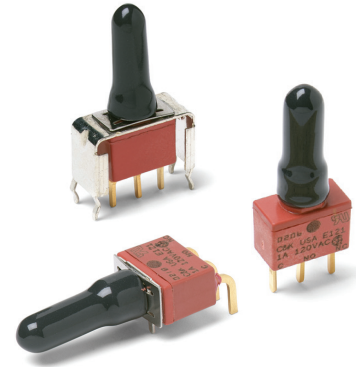

Models Available

Specifications

CONTACT RATING: B contact material (EX25 Models): 0.4 VA max. @ 20 V AC or DC max. G contact material (EX21 Models): 1 AMP @120 V AC or 28 V DC or 0.4 VA max. @ 20 V AC or DC max. Note: Break-before-make contacts. Multi-pole contacts do not make and break simultaneously. See page A-26 for additional ratings.

ELECTRICAL LIFE: 60,000 make-and-break cycles at full load.

CONTACT RESISTANCE: Below 50 m21Ω typ. initial @ 2-4 V DC, 100 mA, for both silver and gold plated contacts.

INSULATION RESISTANCE: 10⁹Ω min.

DIELECTRIC STRENGTH: 1000 Vrms min. @ sea level.

OPERATING TEMPERATURE: -30°C to 75°C.

CAP INSTALLATION FORCE: 10 lbs. max. permissible.

SOLDERABILITY: Per MIL-STD-202F method 208D, or

EIA RS-186E method 9 (1 hour steam aging).

NOTE: Any models supplied with P, R, B or G contact material are RoHS compliant.

NOTE: Specifications and materials listed above are for switches with standard options. For information on specific and custom switches, consult Customer Service Center.

Materials

CASE & BUSHING: Glass filled nylon 6/6, flame retardant (UL 94V-0).

PLUNGER: Glass filled nylon or glass filled polyester (PBT) (UL 94V-0).

SWITCH SUPPORT: Brass or steel, matte-tin.

SWITCH SUPPORT RETAINER: Stainless steel.

N.O. & N.C. CONTACTS: EX25 MODELS: B contact material: Copper alloy, with gold plate over nickel plate. EX21 MODELS: G contact material: Coin silver, with gold plate over nickel plate. See page A-26 for additional contact materials.

COMMON CONTACTS & ALL TERMINALS: Copper alloy, with gold plate over nickel plate. See page A-26 for additional contact materials.

TERMINAL SEAL: Epoxy.

DISPOSABLE BOOT: Vinyl splashproof boot supplied standard. Remove and discard only after soldering and cleaning processes are complete.

Build-A-Switch

To order, simply select desired option from each category and place in the appropriate box. Available options are shown and described on pages A-22 thru A-28. For additional options not shown in catalog, consult our Customer Service Center. All models are process sealed to withstand machine soldering temperatures and pressure wash cleaning methods.



Switch Function

- E121** SPDT On-Mom. 1 Amp
- E221** DPDT On-Mom. 1 Amp
- E125** SPDT On-Mom. 0.4VA
- E225** DPDT On-Mom. 0.4VA

Plunger

- S** .282" high
- M** .331" high, snap-fitting
- S1** .332" high

Bushing

- D1** Unthreaded
- D3** .180" high, unthreaded

Terminations

- A** Right angle, PC thru-hole
- AV2** Vertical right angle, PC thru-hole
- C** PC Thru-hole
- A3** Right angle, snap-in, PC thru-hole
- AV3** Vertical right angle, snap-in, PC thru-hole
- V3** .460" high, V-bracket
- V4** .630" high, V-bracket
- V6** .460" high, V-bracket
- V8** .953" high, V-bracket
- V31** .460" high, snap-in V-bracket
- V41** .630" high, snap-in V-bracket
- V61** .460" high, snap-in V-bracket

Contact Material

- B** Gold
- G** Gold over silver
- P** Gold, matte-tin
- R** Gold over silver, matte-tin

Seal

- E** Epoxy and disposable splashproof boot



5 Aug 20

Dimensions are shown: Inches (mm)
Specifications and dimensions subject to change

E020 Series Sealed Snap-acting Momentary Pushbutton Switches

SWITCH FUNCTION

NO. POLES	MODEL NO.	SWITCH FUNCTION		CONNECTED TERMINALS		SCHEMATIC
		POS. 1	POS. 2	POS. 1	POS. 2	
SP	E121	ON	MOM.	1-3	1-2	
	E125	ON	MOM.			
SPDT						
Part number shown: E121SD1CGE Terminal Nos. For Reference Only						
DP	E221	ON	MOM.	1-3,4-6	1-2,4-5	
	E225	ON	MOM.			
DPDT						
Part number shown: E221SD1CBE Terminal Nos. For Reference Only						

MOM. = Momentary

E121, E221 models with all options when ordered with G or R contact material.

EX25 models must be ordered with B or P contact material.
EX21 models must be ordered with G or R contact material.

PLUNGER

S .282" HIGH

S1 .332" HIGH

Not Available with D1 bushing.

M .332" HIGH SNAP-FITTING

NOTE: Caps available for all plunger options, see page A-27.

BUSHING

D1 UNTHREADED

D3 .180" HIGH UNTHREADED

Not available with S1 actuator.

NOTE: Disposable splashproof vinyl over actuator and bushing supplied std., see page A-26.

5 Aug 20

Dimensions are shown: Inches (mm)
Specifications and dimensions subject to change

A-22

www.ckswitches.com

E020 Series Sealed Snap-acting Momentary Pushbutton Switches



A Pushbutton

TERMINATIONS

C PC THRU-HOLE

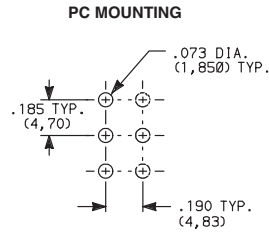
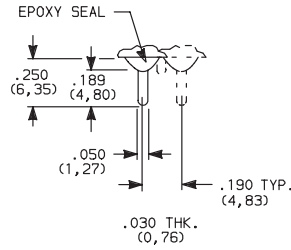

SPDT and DPDT

A RIGHT ANGLE, PC THRU-HOLE

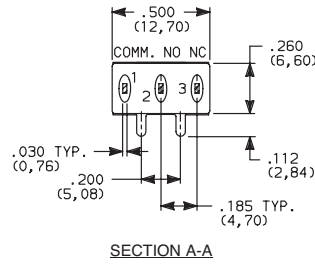
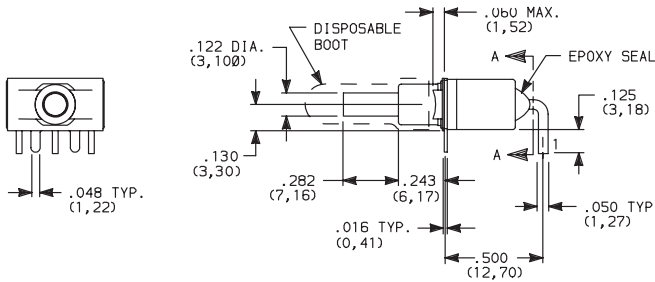

E121SD1AGE
SPDT

A3 RIGHT ANGLE, SNAP-IN, PC THRU-HOLE

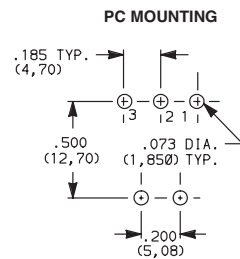

NOTE: Terminal bend radii and lead-in manufacturing option.

A RIGHT ANGLE, PC THRU-HOLE

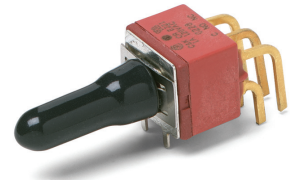
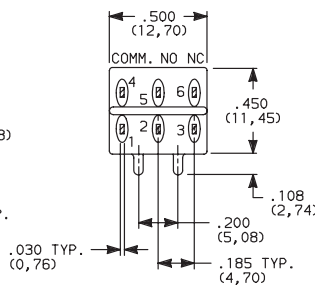
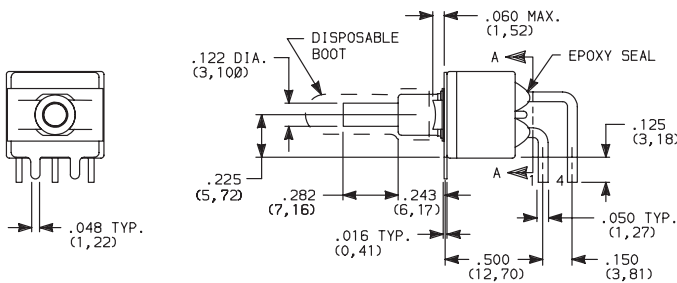

E221SD1AGE
DPDT

A3 RIGHT ANGLE, SNAP-IN, PC THRU-HOLE

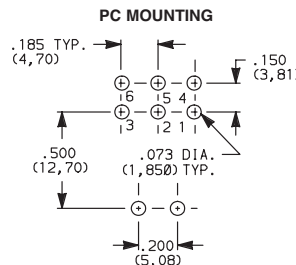

NOTE: Terminal bend radii and lead-in manufacturing option.

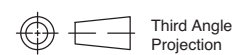



E020 Series Sealed Snap-acting Momentary Pushbutton Switches

TERMINATIONS



Pushbutton

A

AV2 VERTICAL RIGHT ANGLE, PC THRU-HOLE, .150" PITCH

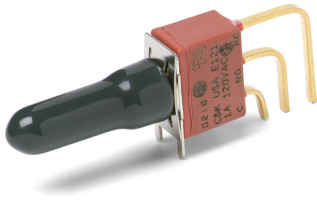

E121SD1AV2GE
SPDT

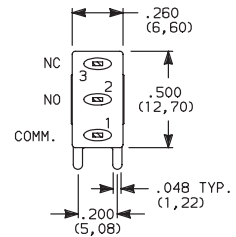
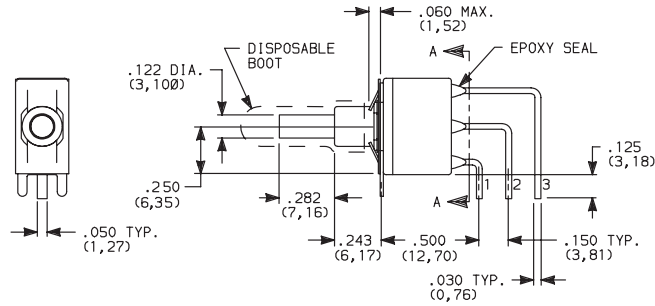

SECTION A-A

AV3 VERTICAL RIGHT ANGLE, SNAP-IN, PC THRU-HOLE, .150" PITCH

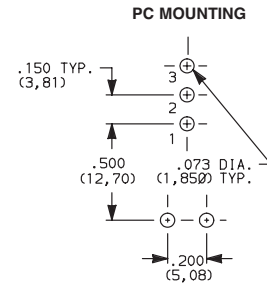
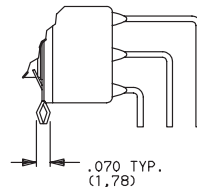
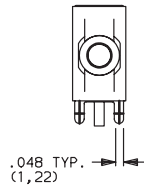

NOTE: Terminal bend radii and lead-in manufacturing option.

AV2 VERTICAL RIGHT ANGLE, PC THRU-HOLE, .150" PITCH

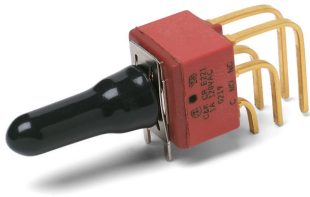

E221SD1AV2GE
DPDT

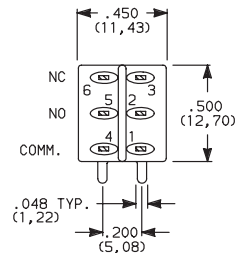
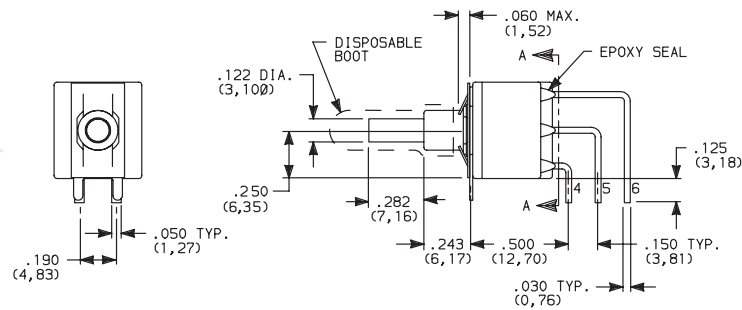

SECTION A-A

AV3 VERTICAL RIGHT ANGLE, SNAP-IN, PC THRU-HOLE, .150" PITCH

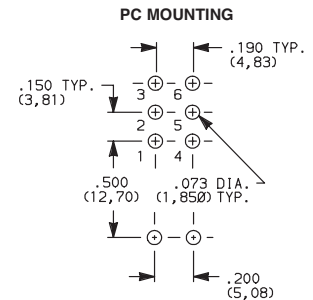
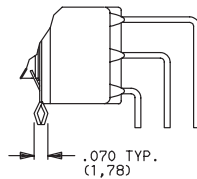
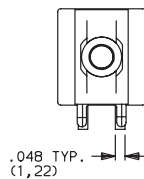

NOTE: Terminal bend radii and lead-in manufacturing option.

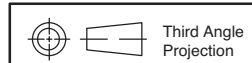

5 Aug 20

Dimensions are shown: Inches (mm)
Specifications and dimensions subject to change

E020 Series Sealed Snap-acting Momentary Pushbutton Switches



A Pushbutton

TERMINATIONS

V3, V4 VERTICAL MOUNT, V-BRACKET

V31, V41 VERTICAL MOUNT, V-BRACKET, SNAP-IN

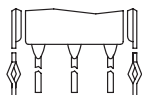
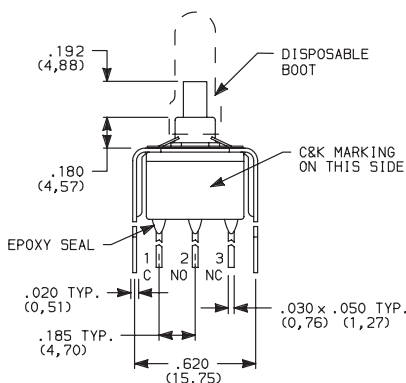

SNAP-IN

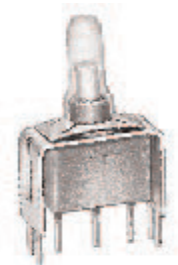
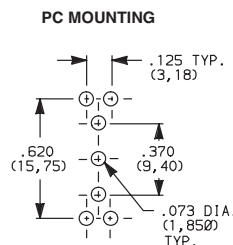
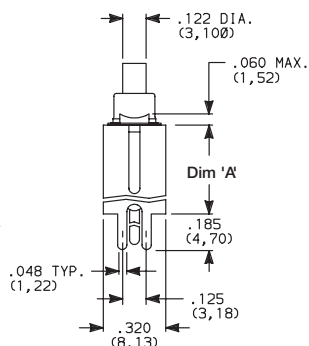

E121SD3_GE SPDT

OPTION CODE	DIM 'A'
V3, V31	.460 (11,68)
V4, V41	.630 (16,00)

V3, V4 VERTICAL MOUNT, V-BRACKET

V31, V41 VERTICAL MOUNT, V-BRACKET, SNAP-IN

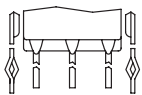
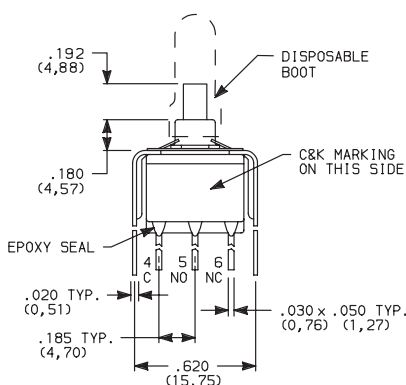

SNAP-IN

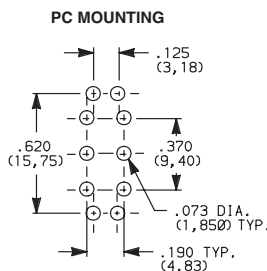
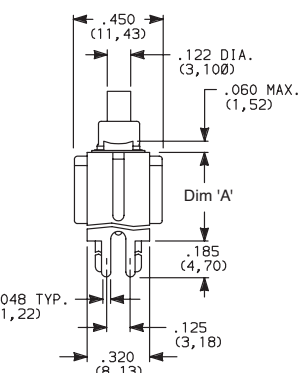

E221SD3_GE DPDT

OPTION CODE	DIM 'A'
V3, V31	.460 (11,68)
V4, V41	.630 (16,00)

V6, V8 VERTICAL MOUNT, V-BRACKET

V61, V81 VERTICAL MOUNT, V-BRACKET, SNAP-IN

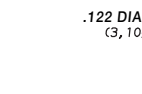
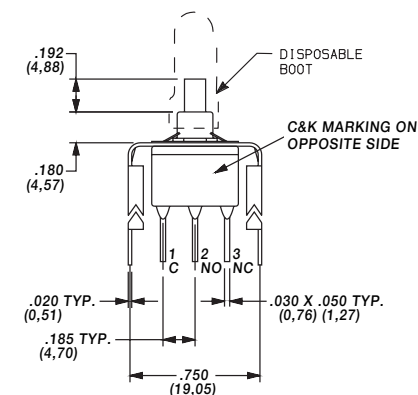

SNAP-IN

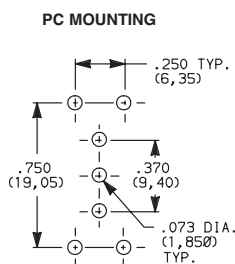
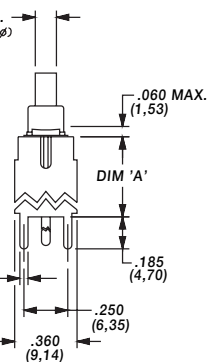

E121SD3_GE SPDT

OPTION CODE	DIM 'A'
V6, V61	.460 (11,68)
V8, V81	.953 (24,21)

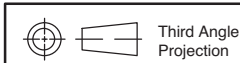

Third Angle Projection



5 Aug 20

Dimensions are shown: Inches (mm)
Specifications and dimensions subject to change



E020 Series Sealed Snap-acting Momentary Pushbutton Switches

Pushbutton

A

TERMINATIONS

V6, V8 VERTICAL MOUNT, V-BRACKET

V61, V81 VERTICAL MOUNT, V-BRACKET, SNAP-IN



E221SD3V6GE DPDT

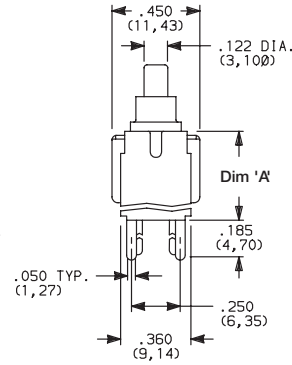
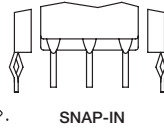
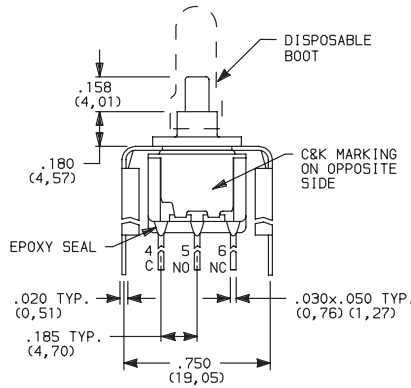

PC MOUNTING

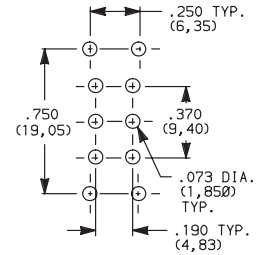

OPTION CODE	DIM 'A'
V6, V61	.460 (11,68)
V8, V81	.953 (24,21)

CONTACT MATERIAL

OPTION CODE	CONTACT MATERIAL	TERMINAL PLATING	RATINGS	
B	GOLD ¹	GOLD ¹	LOW LEVEL/DRY CIRCUIT	EX25 MODELS ONLY: 0.4 VA MAX. @ 20 V AC OR DC MAX.
P		MATTE-TIN ⁴		
G	GOLD OVER SILVER ^{2,3}	GOLD ³	LOW LEVEL/DRY CIRCUIT OR POWER	EX21 MODELS ONLY: 0.4 VA MAX @ 20 V AC OR DC MAX. OR 1 AMP @ 120 V AC OR 28 V DC.
R		MATTE-TIN ⁴		

* Note: See Technical Data section of this catalog for RoHS compliant and compatible definitions and specifications.

- CONTACTS & TERMINALS: Copper alloy, with gold plate over nickel plate.
- N.O. AND N.C. CONTACTS: Coin silver, with gold plate over nickel plate.
- COMMON CONTACTS & ALL TERMINALS: Copper alloy, with gold plate over nickel plate.
- TERMINALS: Copper alloy, with matte-tin alloy over nickel plate.

NOTE: Any models supplied with P, R, B or G contact material are RoHS compliant.

E121, E221 models with all options when ordered with mandatory G, or R contact material.
P or B contact material must be ordered with EX25 models.
R or G contact material must be ordered with EX21 models.

SEAL

E EPOXY SEAL AND DISPOSABLE SPLASHPROOF BOOT

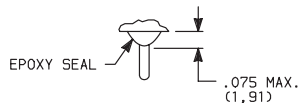

Disposable splashproof boot supplied standard. Remove and discard boot *only after* soldering and cleaning processes are complete.

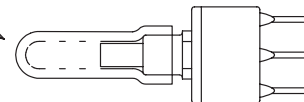

5 Aug 20

Dimensions are shown: Inches (mm)
Specifications and dimensions subject to change

www.ckswitches.com

E020 Series Sealed Snap-acting Momentary Pushbutton Switches



A
Pushbutton

AVAILABLE HARDWARE

Cap

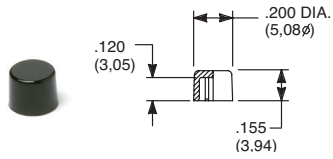

PART NO.
708901000 WHITE
708902000 BLACK
708903000 RED
 Material: Nylon
 Finish: Gloss

Cap

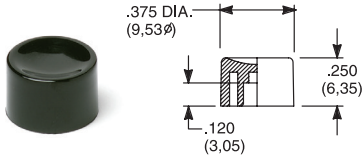

PART NO.
752701000 WHITE
752702000 BLACK
752703000 RED
 Material: Nylon
 Finish: Gloss

Cap

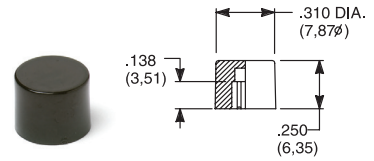

PART NO.
801801000 WHITE
801802000 BLACK
801803000 RED
 Material: Nylon
 Finish: Gloss

Cap, Snap-fitting plunger

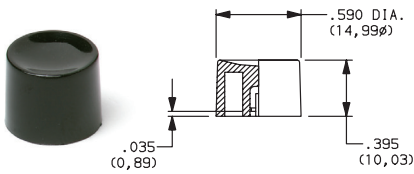

PART NO.
452D01000 WHITE
452D02000 BLACK
452D03000 RED
 Material: Nylon
 Finish: Gloss

Cap, Snap-fitting plunger

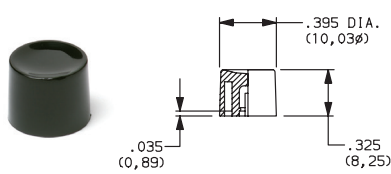

PART NO.
894101000 WHITE
894102000 BLACK
894103000 RED
 Material: Nylon
 Finish: Gloss

Cap

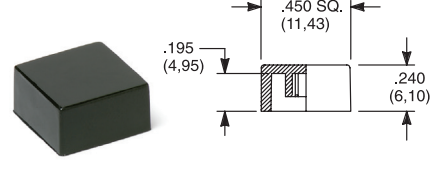

PART NO.
484601000 WHITE
484602000 BLACK
484603000 RED
 Material: Nylon
 Finish: Gloss

PART NO.
798201000 WHITE
798202263 BLACK
798203000 RED
 Material: Nylon
 Finish: Matte

NOTE: Other cap colors available, consult Customer Service Center.

Frames snap into panel opening and are independent from switch mounting. Accurate positioning of the PC mounted switch relative to the panel opening is necessary to provide proper clearance between actuator and frame. Available in two basic styles and four panel thicknesses .047-.125 in. Material: Nylon. Finish: Matte.

TYPICAL APPLICATION

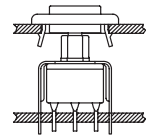

.090" (2,29) PANEL THK. .125" (3,18) PANEL THK.
PART NO. **PART NO.**
432702263 **432802263** BLACK

PANEL MOUNTING

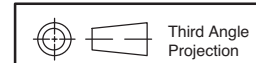
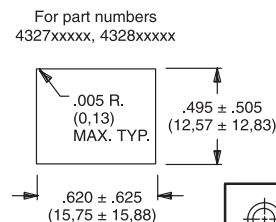
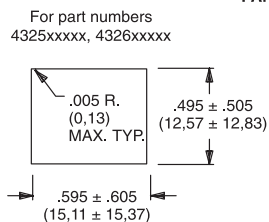



E020 Series Sealed Snap-acting Momentary Pushbutton Switches

AVAILABLE HARDWARE

PANEL INSERTS

Above frames (part nos. 432XXXXXX) are also available with insert which accepts LED for indicator light assembly. Order insert separately from frame. Blank insert panel (without hole for LED) also available. LED not included.

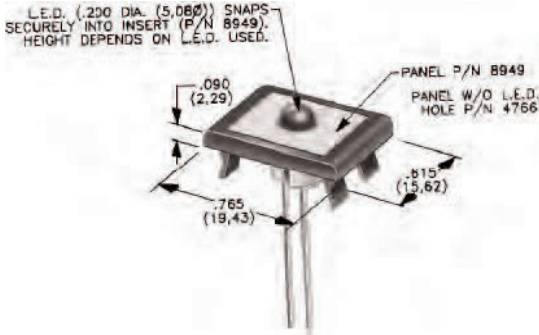

PANEL INSERT
WITH HOLE FOR LED

PART NO.
894902000

BLANK PANEL INSERT
WITHOUT HOLE FOR LED

PART NO.
476602000 BLACK

Special colors, custom markings available, consult Customer Service Center.

X-ON Electronics

Largest Supplier of Electrical and Electronic Components

Click to view similar products for [Pushbutton Switches](#) category:

Click to view products by [C&K](#) manufacturer:

Other Similar products are found below :

[8940K2012](#) [LW1L-M1C10V-A](#) [LW1L-M1C70-A](#) [LW2L-A1C20M-GD](#) [LW2L-M1C20M-A](#) [60324L](#) [M22-D-R-GB0/K11](#) [M7E-HRN2](#)
[67021K512](#) [67081K512X](#) [701PB580](#) [7199K101](#) [810K12910](#) [810KSV30B](#) [MML21EA2ADK](#) [MML21KA3ABK](#) [MML23KA3AC05K-001](#)
[MML23KW3AA01W](#) [8418K2](#) [8442K3](#) [8450K1](#) [860K11911T01A](#) [861901](#) [861K11911T01A07](#) [861K13810T00A14](#) [861K13911](#)
[8646AB6X718UL](#) [8646ABUL](#) [9001KXRK](#) [907AYY100](#) [PMHD155A1](#) [9533CD4+U574+U4922](#) [95-414.000](#) [99-450.837](#) [99-453.837](#)
[PV3H2B0NN-341](#) [1203MRA](#) [A22NZBGANGA](#) [A22NZBNANGA](#) [A22NZMPATRA](#) [A2PMA1X03EC56](#) [A3A-5123-02](#) [A3A-7140](#) [A3A-7310](#) [A3A-7340](#) [A3U-TMW-A2C-5M](#) [A595](#) [12037A2ULCSA](#) [ABD122N-B](#) [1211390004](#)