

# GT Series Sealed Ultraminiature Toggle Switches

## Features/Benefits

- Sealed against solder and cleaning process contaminants
- Ultraminiature size, smallest footprint available
- Thru-hole and surface mount models
- High temperature materials (UL 94V-0)
- RoHS compliant and compatible

## Typical Applications

- Hand-held telecommunications
- Small instrumentation

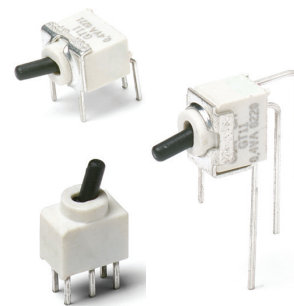

## Specifications

CONTACT RATING: 0.4 VA max. @ 20 V AC or DC max.  
 MECHANICAL & ELECTRICAL LIFE: 40,000 make-and-break cycles at full load.  
 CONTACT RESISTANCE: Below 50 m Ω typ. initial @ 2-4 V DC, 100 mA.  
 INSULATION RESISTANCE: 10<sup>9</sup> Ω min.  
 DIELECTRIC STRENGTH: 500 Vrms min. @ sea level.  
 OPERATING TEMPERATURE: -30°C to 85°C.  
 SOLDERABILITY: Per MIL-STD-202F method 208D, or EIA RS-186E method 9 (1 hour steam aging).  
 PACKAGING: Surface mount switches shipped in anti-static tape and reel packaging per EIA 481-3, see page F-47 for drawings and reel information. Tape and cover strip are conductive for use near statically sensitive components, consult Customer Service Center.

## Materials

HOUSING AND BASE: Glass filled nylon 4/6, flame retardant, heat stabilized (UL 94V-0).  
 ACTUATOR: Glass filled nylon 4/6, flame retardant, heat stabilized (UL 94V-0), with standard internal o-ring seal.  
 SWITCH SUPPORT: Brass, tin plated.  
 MOVABLE CONTACTS: Copper alloy, with gold plate over nickel plate.  
 STATIONARY CONTACTS: Copper alloy, with gold plate over nickel plate.  
 TERMINALS: Gold.  
 TERMINAL SEAL: Epoxy. All terminals insert molded.

**NOTE:** Specifications and materials listed above are for switches with standard options. For information on specific and custom switches, consult Customer Service Center.

## How To Order

Complete part numbers for GT Series Sealed Ultraminiature Toggle Switches are shown on pages F-43 thru F-47.



GT11MCBE  
SPDT

PART NUMBER	SWITCH FUNCTION		
	POS.1	POS. 2	POS. 3
<b>GT11MCBE</b>	ON	NONE	ON
<b>GT13MCBE</b>	ON	OFF	ON
Conn. Terms.	2-3	OPEN	2-1
Schematic			
SPDT	Note: Pins 4 and 6 not connected		
<b>GT12MCBE</b>	OFF	NONE	ON
Conn. Terms.	OPEN	N/A	3-1
Schematic			
SPST	Note: Pins 4 and 6 not connected		

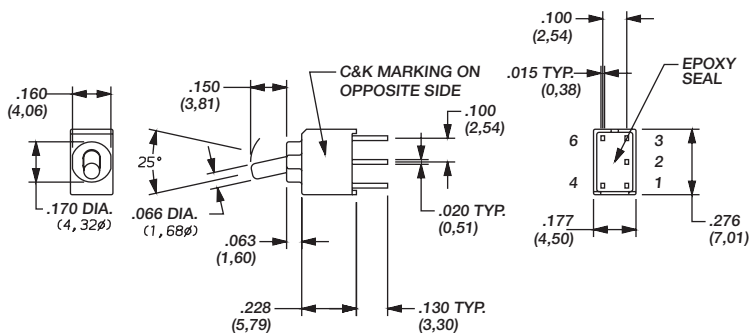

ACTUATOR SHOWN IN POS. 1

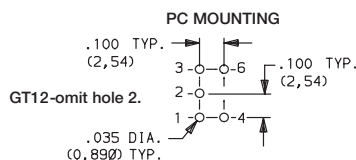

TERMINAL NOS. FOR  
REFERENCE ONLY



# GT Series Sealed Ultraminiature Toggle Switches

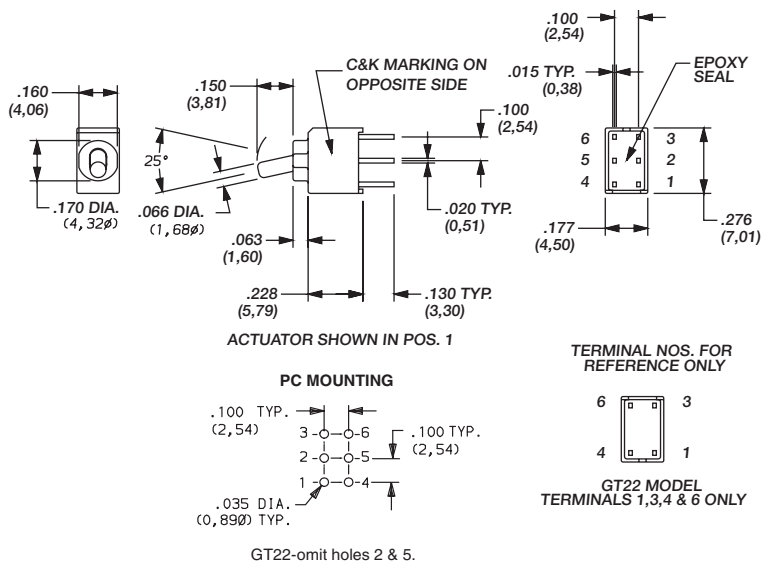

PART NUMBER	SWITCH FUNCTION		
	POS.1	POS. 2	POS. 3
<b>GT21MCBE</b>	ON	NONE	ON
<b>GT23MCBE</b>	ON	OFF	ON
Conn. Terms.	2-3, 5-6	OPEN	2-1, 5-4
Schematic			
DPDT			
<b>GT22MCBE</b>	OFF	NONE	ON
Conn. Terms.	OPEN	N/A	3-1, 6-4
Schematic			
DPST			



GT21MCBE  
DPDT

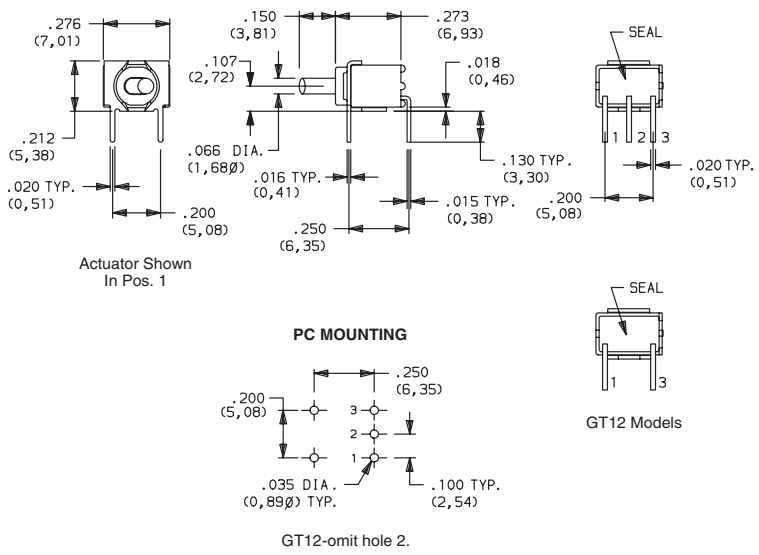

PART NUMBER	SWITCH FUNCTION		
	POS.1	POS. 2	POS. 3
<b>GT11MABE</b>	ON	NONE	ON
<b>GT13MABE</b>	ON	OFF	ON
Conn. Terms.	2-3	OPEN	2-1
Schematic			
SPDT			
<b>GT12MABE</b>	OFF	NONE	ON
Conn. Terms.	OPEN	N/A	3-1
Schematic			
SPST			



GT11MABE  
Horizontal Actuation  
SPDT

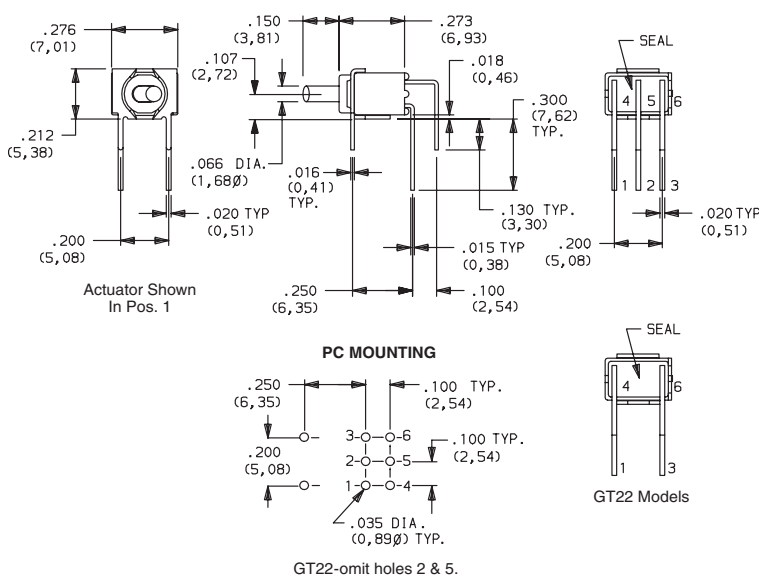

PART NUMBER	SWITCH FUNCTION		
	POS.1	POS. 2	POS. 3
<b>GT21MABE</b>	ON	NONE	ON
<b>GT23MABE</b>	ON	OFF	ON
Conn. Terms.	2-3, 5-6	OPEN	2-1, 5-4
Schematic			
DPDT			
<b>GT22MABE</b>	OFF	NONE	ON
Conn. Terms.	OPEN	N/A	3-1, 6-4
Schematic			
DPST			

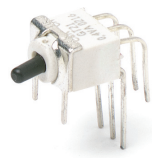

GT21MABE  
Horizontal Actuation  
DPDT

Toggle F

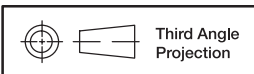

Third Angle Projection  
Dimensions are shown: Inches (mm)  
Specifications and dimensions subject to change

# GT Series Sealed Ultraminiature Toggle Switches



GT11MAVBE  
Vertical  
Actuation  
SPDT

PART NUMBER	SWITCH FUNCTION		
	POS.1	POS. 2	POS. 3
<b>GT11MAVBE</b> <b>GT13MAVBE</b>	ON	NONE	ON
Conn. Terms.	2-3	OPEN	2-1
Schematic			
SPDT			
<b>GT12MAVBE</b>	OFF	NONE	ON
Conn. Terms.	OPEN	N/A	3-1
Schematic			
SPST			

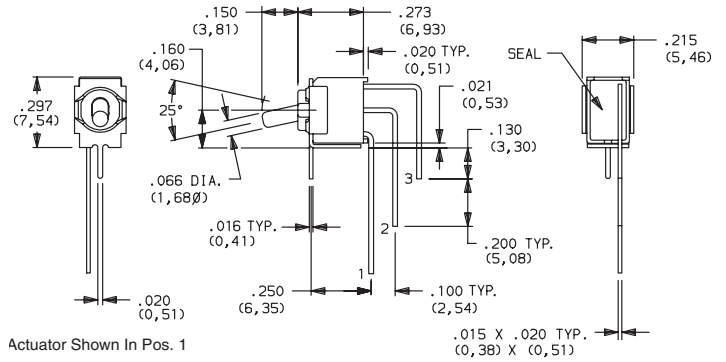

Actuator Shown In Pos. 1

### PC MOUNTING

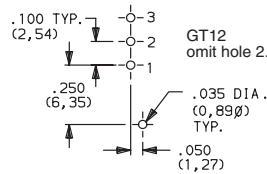

GT12 Models



GT21MAVBE  
Vertical  
Actuation  
DPDT

PART NUMBER	SWITCH FUNCTION		
	POS.1	POS. 2	POS. 3
<b>GT21MAVBE</b> <b>GT23MAVBE</b>	ON	NONE	ON
Conn. Terms.	2-3, 5-6	OPEN	2-1, 5-4
Schematic			
DPDT			
<b>GT22MAVBE</b>	OFF	NONE	ON
Conn. Terms.	OPEN	N/A	3-1, 6-4
Schematic			
DPST			

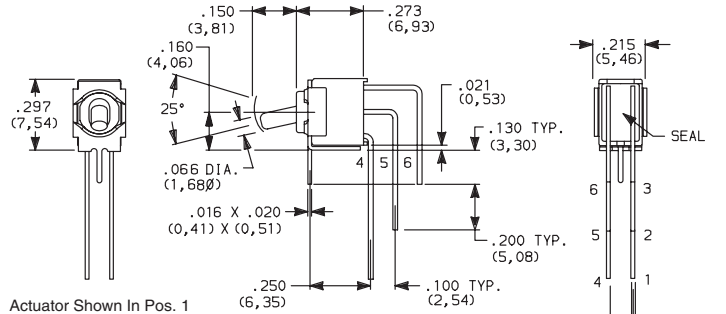

Actuator Shown In Pos. 1

### PC MOUNTING

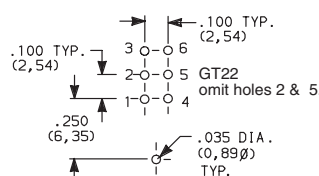

GT22 Models:  
1, 3, 4 & 6 terminals only.

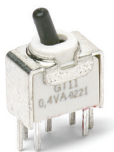

GT11MV3BE  
SPDT

PART NUMBER	SWITCH FUNCTION		
	POS.1	POS. 2	POS. 3
<b>GT11MV3BE</b> <b>GT13MV3BE</b>	ON	NONE	ON
Conn. Terms.	2-3	OPEN	2-1
Schematic			
SPDT	Note: Pins 4 and 6 not connected		
<b>GT12MV3BE</b>	OFF	NONE	ON
Conn. Terms.	OPEN	N/A	3-1
Schematic			
SPST	Note: Pins 4 and 6 not connected		

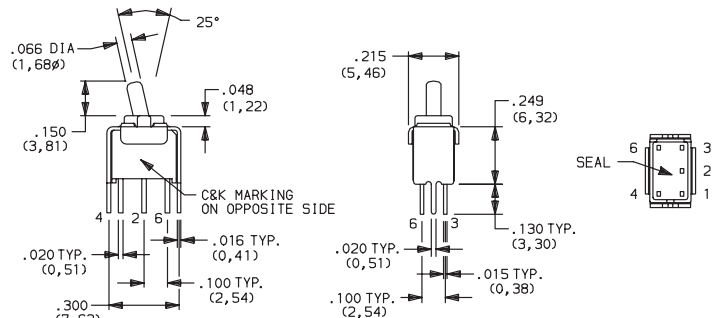

Actuator Shown In Pos. 1

### PC MOUNTING

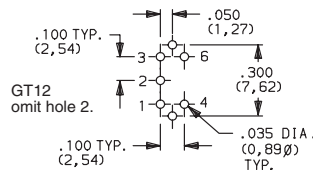

GT12 Models



Dimensions are shown: Inches (mm)  
Specifications and dimensions subject to change



25 Sep 20



F

Toggle

# GT Series Sealed Ultraminiature Toggle Switches

GT21MV3BE  
DPDT

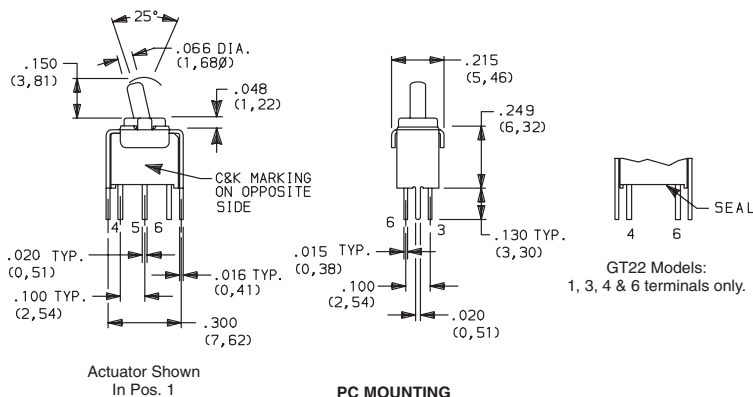

PART NUMBER	SWITCH FUNCTION		
	POS. 1	POS. 2	POS. 3
GT21MV3BE	ON	NONE	ON
GT23MV3BE	ON	OFF	ON
Conn. Terms.	2-3, 5-6	OPEN	2-1, 5-4
Schematic			
DPDT			
GT22MV3BE	OFF	NONE	ON
Conn. Terms.	OPEN	N/A	3-1, 6-4
Schematic			
DPST			

GT11MSABE  
Horizontal  
Actuation  
SPDT

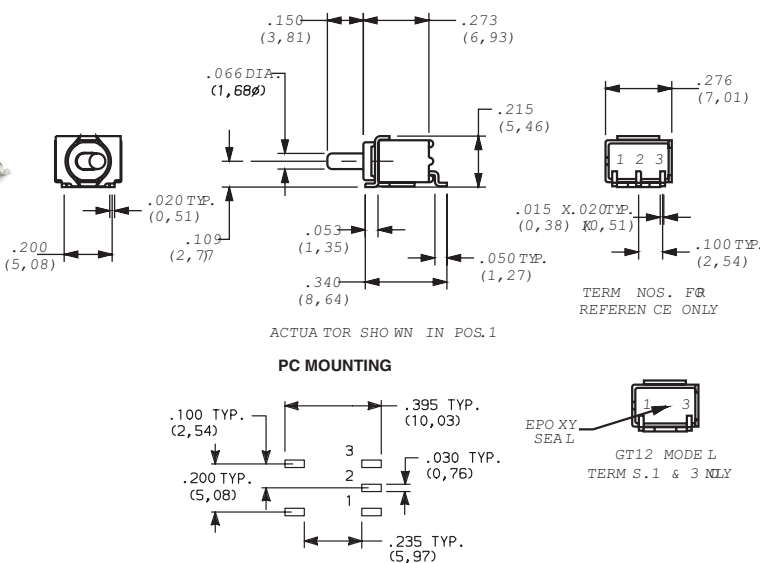

PART NUMBER	SWITCH FUNCTION		
	POS. 1	POS. 2	POS. 3
GT11MSABETR	ON	NONE	ON
GT13MSABETR	ON	OFF	ON
Conn. Terms.	2-3	OPEN	2-1
Schematic			
SPDT			
GT12MSABETR	OFF	NONE	ON
Conn. Terms.	OPEN	N/A	3-1
Schematic			
SPST			

Standard with tape & reel packaging, see page F-47.

GT12-omit pad 2.

GT11MSCBE  
SPDT

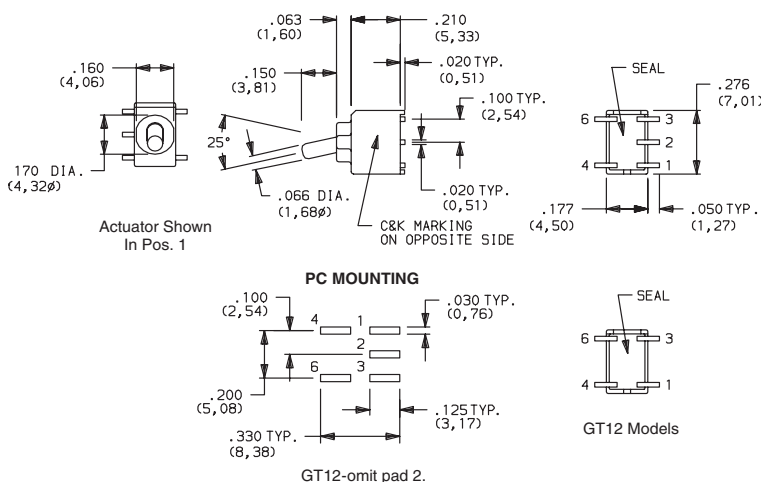

PART NUMBER	SWITCH FUNCTION		
	POS. 1	POS. 2	POS. 3
GT11MSCBETR	ON	NONE	ON
GT13MSCBETR	ON	OFF	ON
Conn. Terms.	2-3	OPEN	2-1
Schematic			
SPDT	Note: Pins 4 and 6 not connected		
GT12MSCBETR	OFF	NONE	ON
Conn. Terms.	OPEN	N/A	3-1
Schematic			
SPST	Note: Pins 4 and 6 not connected		

Standard with tape & reel packaging, see page F-47.

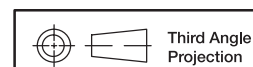

Dimensions are shown: Inches (mm)  
Specifications and dimensions subject to change

# GT Series Sealed Ultraminiature Toggle Switches



GT21MSCBE  
DPDT

PART NUMBER	SWITCH FUNCTION		
	POS.1	POS. 2	POS. 3
<b>GT21MSCBETR</b>	ON	NONE	ON
<b>GT23MSCBETR</b>	ON	OFF	ON
Conn. Terms.	2-3, 5-6	OPEN	2-1, 5-4
Schematic			
DPDT			
<b>GT22MSCBETR</b>	OFF	NONE	ON
Conn. Terms.	OPEN	N/A	3-1, 6-4
Schematic			
DPST			

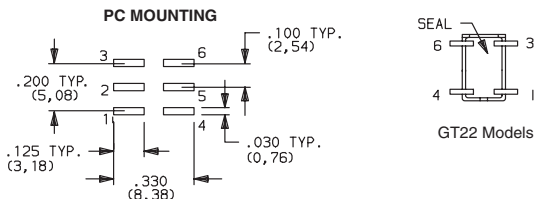
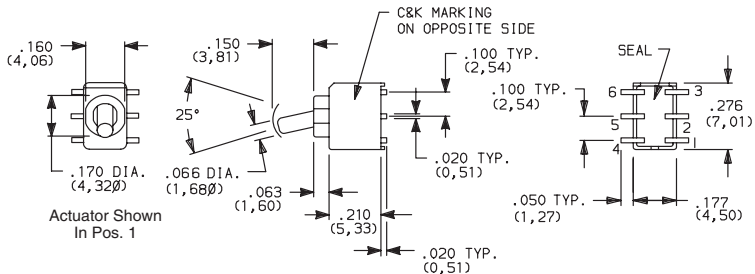

GT22-omit pads 2 & 5.  
Standard with tape & reel packaging

## TAPE & REEL

For part numbers GT11MSABE, GT12MSABE, GT13MSABE

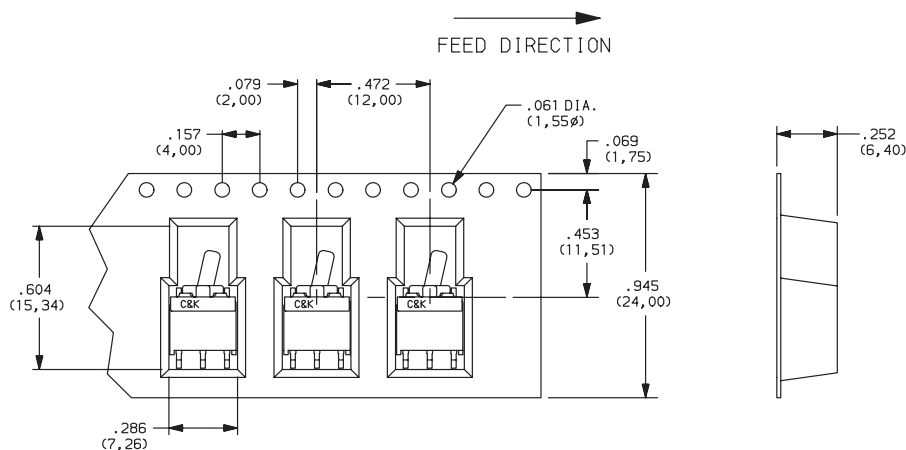

REEL INFORMATION	
OUTSIDE DIAMETER	13.00 (330,0)
PILOT HOLE	.512 (13,0)
QUANTITY PER REEL	600

For part numbers GT11MSCBE, GT12MSCBE, GT13MSCBE, GT21MSCBE, GT22MSCBE, GT23MSCBE,

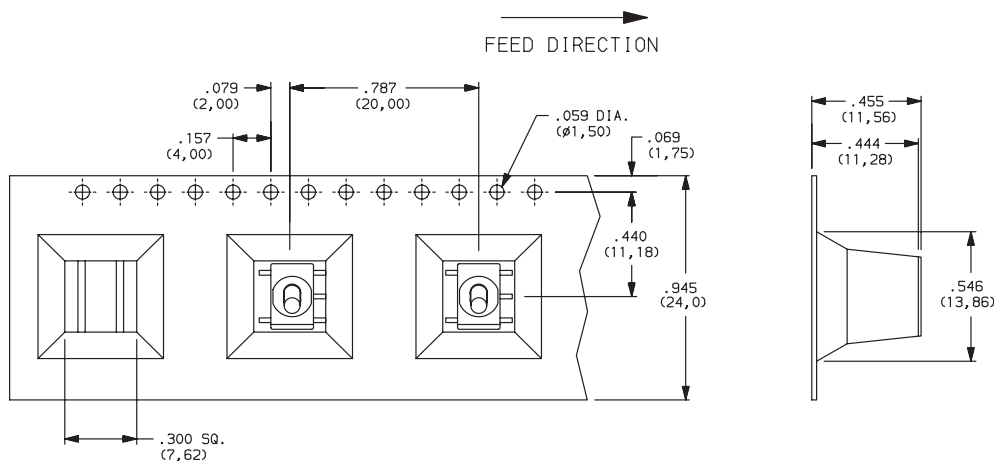

REEL INFORMATION	
OUTSIDE DIAMETER	13.00 (330,0)
PILOT HOLE	.512 (13,0)
QUANTITY PER REEL	200

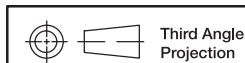

Dimensions are shown: Inches (mm)  
Specifications and dimensions subject to change

## X-ON Electronics

Largest Supplier of Electrical and Electronic Components

*Click to view similar products for [Toggle Switches](#) category:*

*Click to view products by [C&K](#) manufacturer:*

Other Similar products are found below :

[8928K478](#) [8A1-C-222](#) [020017-13](#) [60012L](#) [6006L](#) [CS115W](#) [CS120W](#) [6663](#) [7101SPDV30BE](#) [7103SDV30BE](#) [7105D](#) [7108P3YAV2BE](#)  
[71YY50282](#) [7300K36](#) [7301K38](#) [7306K36](#) [7310K36](#) [7506K4](#) [7592K6](#) [7660K12](#) [7691K14](#) [7700K1](#) [8391K108](#) [8396K108](#) [8811K17](#)  
[8812K14](#) [8824K14](#) [8828K13](#) [8835K3](#) [8858K44](#) [PS83-121G](#) [1-1825192-0](#) [A201SCWZB04](#) [A207SYCB04](#) [A208J61ZQ0004](#) [A221T1TCQ](#)  
[A323S1CWZQ](#) [A423S1CWZG-M8](#) [1201W](#) [12156AX408](#) [12147AGKX679](#) [12246X778](#) [12TW49-3D](#) [130312](#) [13037L](#) [13001X](#)  
[AE101MD1W4B04](#) [AE208SD1W4B04](#) [MS24659-22D](#) [MS27407-5](#)