

HS Series Hook Switches



Features/Benefits

- Connect headsets and phones
- Answer and hang up for telephone
- Various lever designs

Typical Applications

- Telecommunication
- Computer peripherals
- Medical devices

Specifications

CONTACT ARRANGEMENT: DPDT
 CONTACT RATING: 0.2 A @ 30 VDC
 INITIAL CONTACT RESISTANCE: 50 m Ω max.
 INSULATION RESISTANCE: 100M Ω min. @ 500 VDC
 DIELECTRIC STRENGTH: 500 V AC (50-60 Hz)
 OPERATING TEMPERATURE: -20°C to + 70°C
 OPERATING FORCE: 50 ± 20 gf

Materials

LEVER: POM (UL94 HB)
 COVER: POM (UL94 HB)
 TERMINAL: Silver plated

NOTE: Specifications and materials listed above are for switches with standard options. For information on specific and custom switches, consult Customer Service Center.

PART NUMBER	LIFE CYCLE	PACKAGING
HS-2206-A1 NS	300,000 cycles	5,000 pieces

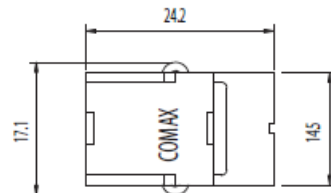

TRAVEL POSITION (X)			
①	③	ON	OFF
②	③	OFF	ON
④	⑥	ON	OFF
⑤	⑥	OFF	ON

6.85 Max 2.65 Min (m/m)

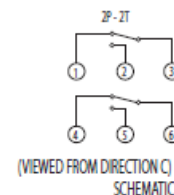
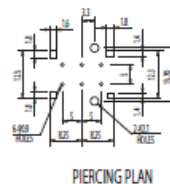
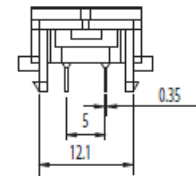
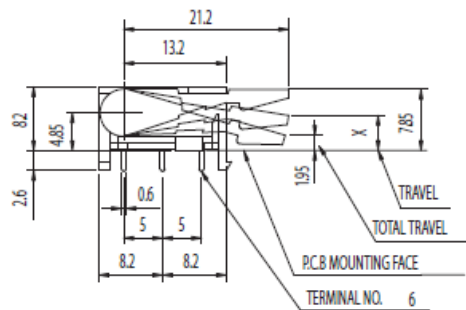

m

Detect

HS Series Hook Switches

PART NUMBER	LIFE CYCLE	PACKAGING
HS-2206-D NS	100,000 cycles	5,000 pieces

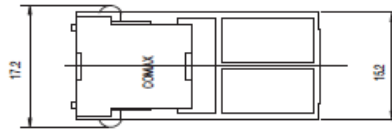

TRAVEL POSITION (Q)			
①	③	ON	OFF
②	③	OFF	ON
④	⑤	ON	OFF
⑤	⑤	OFF	ON

0 1.5Min. 5.2Max. (m/m)

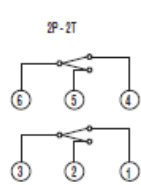
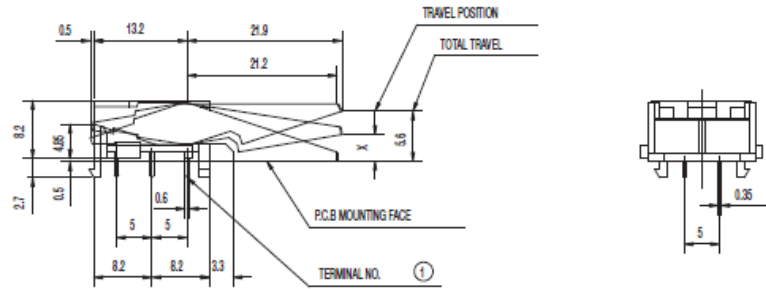

SCHEMATIC

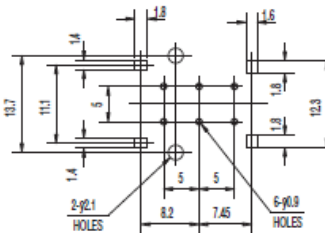

PIERCING PLAN

PART NUMBER	LIFE CYCLE	PACKAGING
HS-2206-E NS	100,000 cycles	5,000 pieces

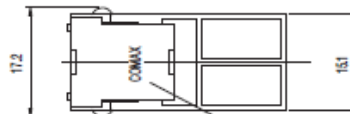

TRAVEL POSITION (Q)			
①	③	ON	OFF
②	③	OFF	ON
④	⑤	ON	OFF
⑤	⑤	OFF	ON

0 1.5Min. 5.9Max. (m/m)

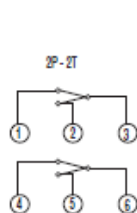
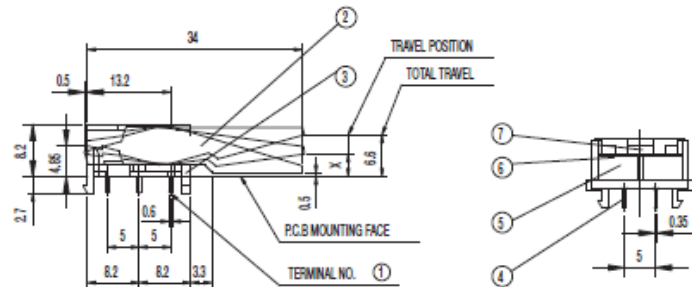

SCHEMATIC

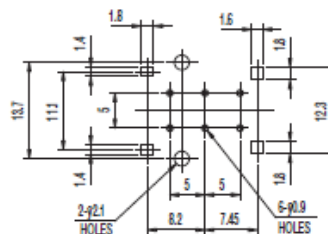

PIERCING PLAN



X-ON Electronics

Largest Supplier of Electrical and Electronic Components

Click to view similar products for [Basic / Snap Action Switches](#) category:

Click to view products by [C&K](#) manufacturer:

Other Similar products are found below :

[5SM901-S12](#) [5SM9-S12N195](#) [602EN532](#) [602EN535-RB](#) [602HE5-RB1](#) [604HE162](#) [604HE223-6B](#) [624HE17-RB](#) [6HM82](#) [6HM89](#) [6SE1](#)
[6SX1-H58](#) [70500216](#) [70599106](#) [MBD5B1](#) [MBH2731](#) [73-316-0012](#) [EXD-AR20](#) [79211923](#) [79218589](#) [7AS12](#)
[MIL30126AB6BBMD4A12XAU](#) [ML-1155](#) [ML-1376](#) [831010C3.0](#) [831090C2.EL](#) [83131904](#) [84212012](#) [8AS239](#) [8HM73-3](#) [8SX26-H33](#)
[914CE1-6G](#) [PL-100](#) [11SM1077-H4](#) [11SM1077-H58](#) [11SM1-TN107](#) [11SM405](#) [11SM8423-H2](#) [11SX37-T](#) [11SX48-H58](#) [11SM2442-T](#)
[11SM76-T](#) [11SM77-H58](#) [11SM77-T](#) [11SM863-T](#) [11SM866](#) [A7CN-1M-1-LEFT](#) [A831700C7.0](#) [121EN188-R](#) [1245.0120](#)