

JSM Series Sub-Miniature Slide Switches

Features/Benefits

- RoHS compliant and meets all requirements of RoHS directive 2002/95EC, Halogen Free
- Positive detent
- Low profile
- IR reflow to 260° solder profile
- Surface and thru hole mounting
- Maintained and momentary functions
- SP3T model

Typical Applications

- Telecommunication products
- Computer peripherals
- Thermostat select switch
- Instrumentations



Specifications

CONTACT RATING: 4 VDC @ 0.3A
 ELECTRICAL LIFE: 10,000 make-and-break cycles at full load.
 CONTACT RESISTANCE: 70 m Ω max.
 INSULATION RESISTANCE: 100 M Ω min. @ 500V.
 DIELECTRIC STRENGTH: 100 VAC min. @ sea level.
 OPERATING TEMPERATURE: -10°C to +60°C
 STORAGE TEMPERATURE: -30°C to +85°C

NOTE: Specifications and materials listed above are for switches with standard options.
 For information on specific and custom switches, consult Customer Service Center.

Materials

HOUSING: LCP, Glass filled (Halogen free)
 ACTUATOR: 4/6 nylon (UL94V-2), black.
 CONTACTS: Beryllium copper, silver plated.
 TERMINALS: Brass, silver plated.
 COVER: Stainless steel
 RETURN SPRING: Stainless steel



Slide

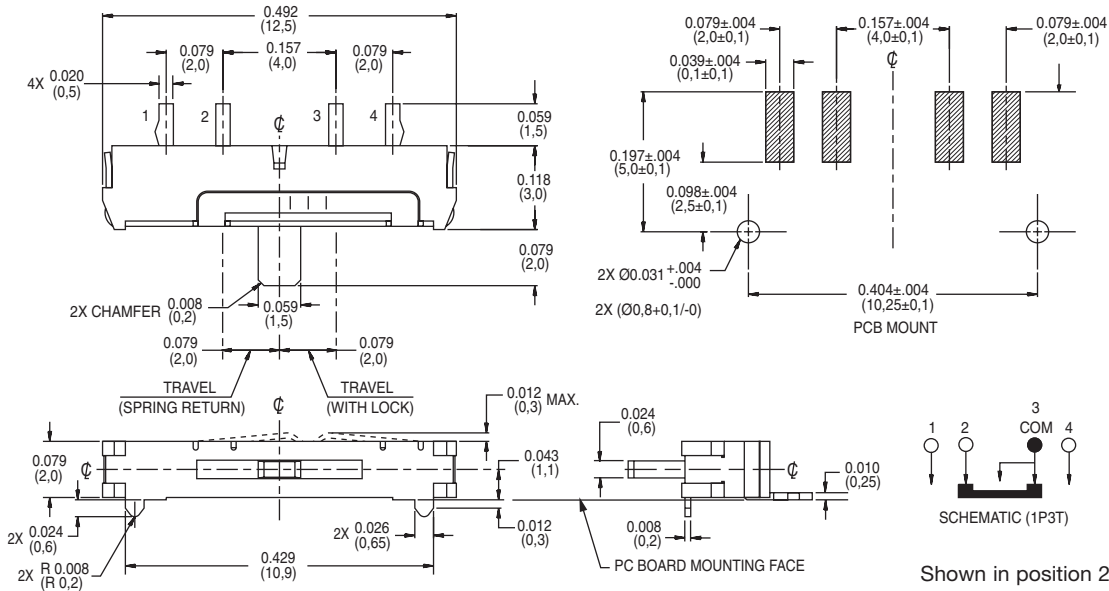

JSM Series Sub-Miniature Slide Switches



JSM07011SAQNL
SP3T Surface Mount
Momentary one side
& Maintained the other

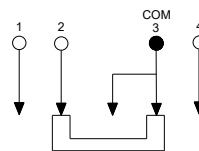
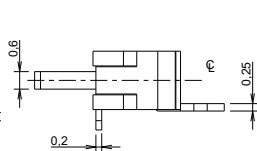
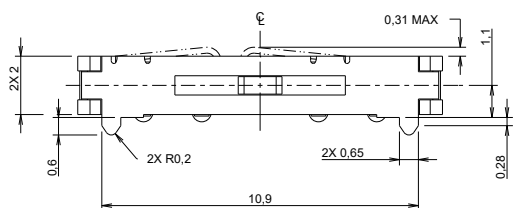
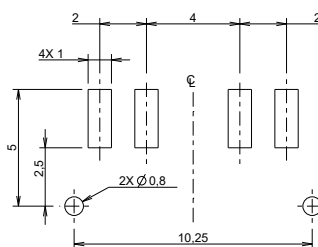
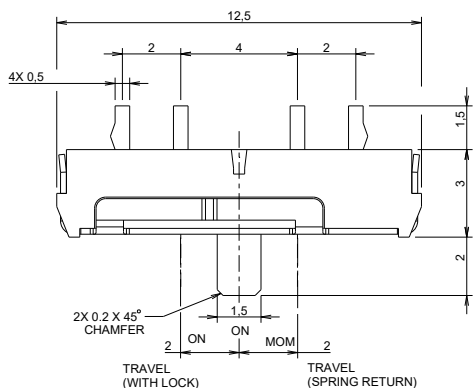

SCHMATIC (1P3T)
Shown in position 2

Packaging for JSM07011SAQNR and JSM07011SAQNL

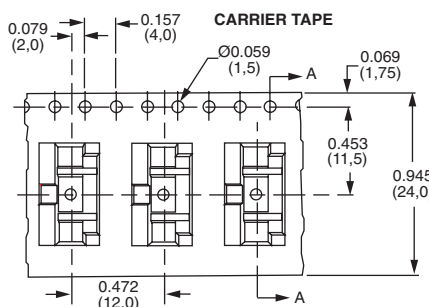
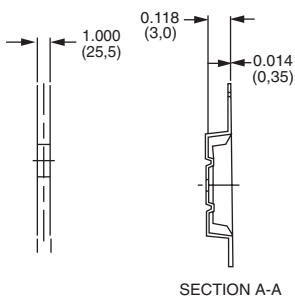
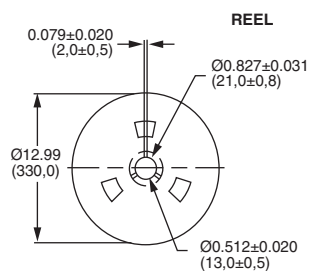

PACKAGING QUANTITY:
1,800 PCS/REEL

X-ON Electronics

Largest Supplier of Electrical and Electronic Components

Click to view similar products for [Slide Switches](#) category:

Click to view products by [C&K](#) manufacturer:

Other Similar products are found below :

[6-1437581-1](#) [M43R](#) [MHS123K15D](#) [MHS133K](#) [MHSS1104A](#) [MMD](#) [GH49S010001](#) [MSS12A](#) [EPS1PC1](#) [1825074-1](#) [1825160-3](#) [1825167-2](#)
[1825289-7](#) [K232CB](#) [25139NLDB](#) [25449NAH](#) [SLB1240R45](#) [1825078-1](#) [1825080-4](#) [1825269-1](#) [1825270-2](#) [STS141RA04](#) [T2215BEN506](#)
[GH46P000001](#) [GH46W000001](#) [GH49P010001](#) [25339NA](#) [M42A](#) [TG36P000000](#) [TG36P000050](#) [AYZ0202AG](#) [47227LFE](#) [49331L](#) [50208L](#)
[L203091MS02Q](#) [4-1437581-7](#) [X2225CR-437W](#) [49329L](#) [1101M1S3ZB8E2](#) [1-1437581-1](#) [MSS2225G04](#) [TG39W000000](#) [1825075-1](#)
[MSS42G](#) [TG36WS80065](#) [T105S1CWZBE](#) [SLB124145](#) [SLB1280R5](#) [SLB1340R45](#) [25136NLDB](#)