



KLS Illuminated SPDT/DPDT Pushbutton

NEW

Pushbutton



Features/Benefits

- Positive tactile feedback
- Momentary or Lock version
- SPDT & DPDT configuration
- Gold or silver contact materials
- Choices of color on LED illumination
- 3 different CAP styles & sizes
- CAP with printed or etched logo*

Typical Applications

- Audio/video system
- Vending machine
- Kiosks
- Network equipment

Specifications

FUNCTION: SPDT, DPDT
 CONTACT ARRANGEMENT: N.C.
 MOUNTING TYPE: Straight PCB terminals

Mechanical

OPERATING LIFE: 1,000,000 cycles
 TOTAL TRAVEL: 2.2 mm
 OPERATING FORCE: 200 ± 100 gf (SPDT)
 300 ± 150 gf (DPDT)

Electrical

CONTACT RATING; See table on contact material
 OPERATING LIFE: 200,000 cycles on both gold & silver plating
 DIELECTRIC STRENGTH: 1,000 V AC for 1 min.
 INSULATION RESISTANCE: 100 MΩ min. @ 500 VDC
 INITIAL CONTACT RESISTANCE: 50 mΩ max. (silver contact)
 100 mΩ max/ (gold contact)

Materials

CASE: PA66+70G33L (Black)
 ACTUATOR: POM (White)
 CAP: PC
 SPRING: Black wire / Stainless steel
 SPRING PLATE: Phosphor bronze
 TERMINALS / CONTACT: Brass / Copper with silver or gold plated
 TERMINAL SEAL: Epoxy

Operating Environment

OPERATING TEMPERATURE: -40°C to +85°C

Note: Specifications and materials listed above are for switches with standard options. For information on specific and custom switches, consult Customer Service Center.

Build-A-Switch

To order, simply select desired option from each category and place it in the appropriate box.

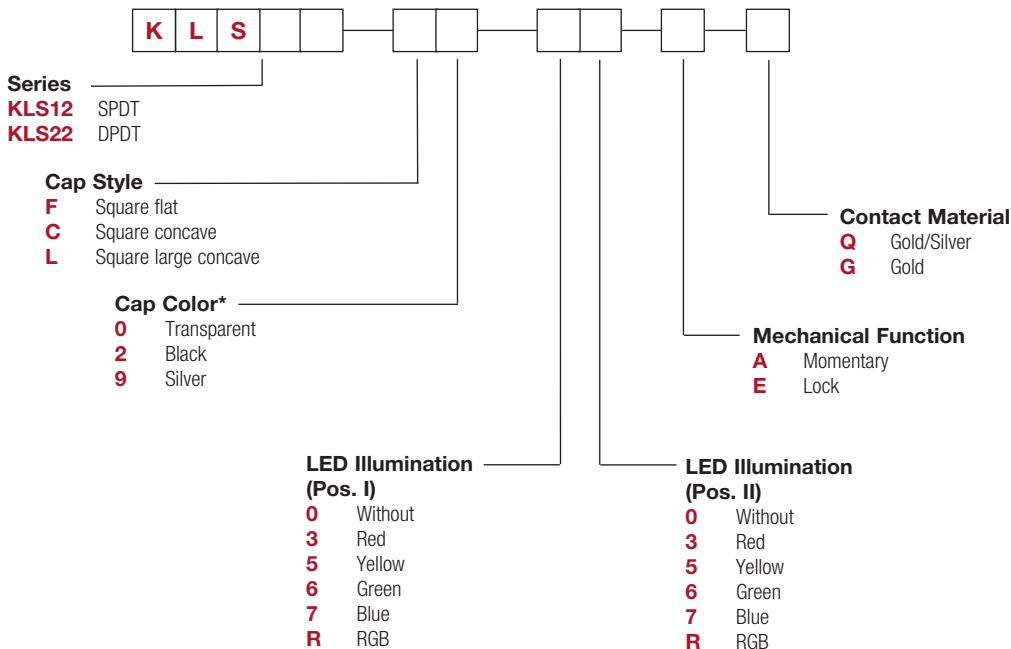

* For CAP with logo or symbol, please contact your sales representative.



NEW

KLS Illuminated SPDT/DPDT Pushbutton



A
Pushbutton

SERIES

KLS12

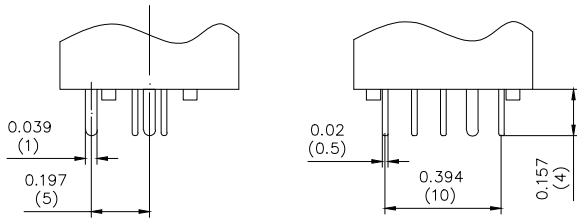

KLS22

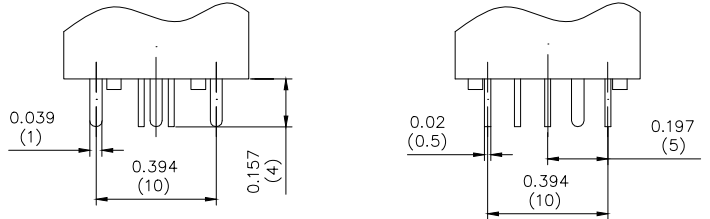

NO. POLES	MODEL NO.	SWITCH FUNCTION		CONNECTED TERMINALS		SCHEMATIC
		POS. 1	POS. 2	POS. 1	POS. 2	
SP	KLS12	ON	(ON)	1-3	1-2	
DP	KLS22	ON	(ON)	1-3,4-6	1-2,4-5	

()=Momentary

CAP

F SQUARE FLAT

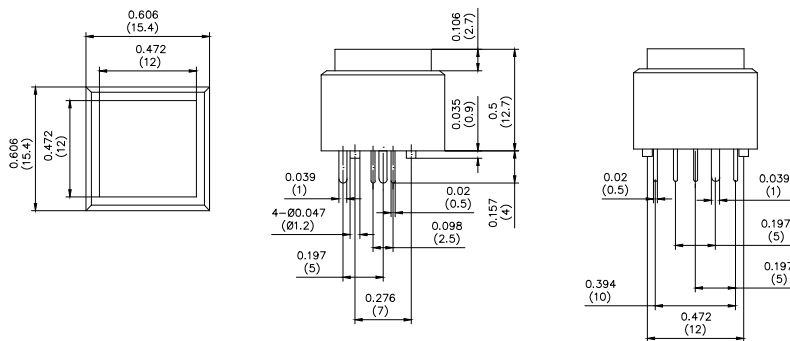

C SQUARE CONCAVE

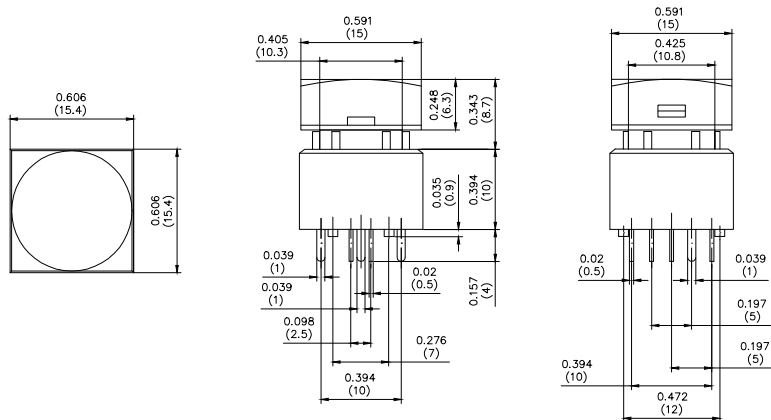

Third Angle Projection



8 Jul 20



KLS Illuminated SPDT/DPDT Pushbutton

NEW

Pushbutton

A

CAP

L SQUARE LARGE CONCAVE

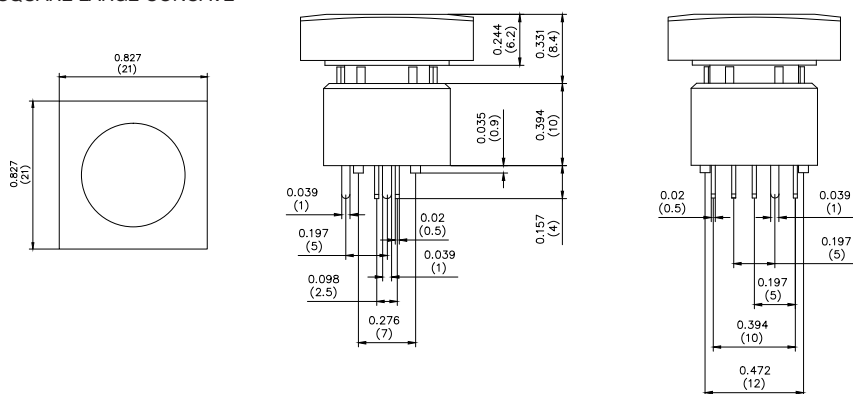

TERMINATION - PCB LAYOUT

KLS12

KLS22

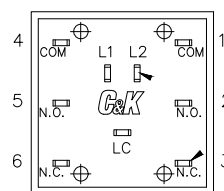
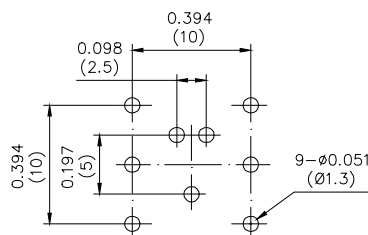
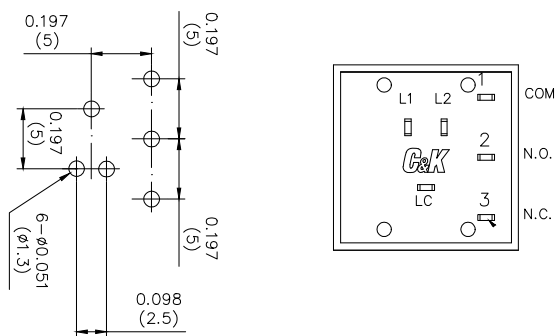

DUAL COLOUR

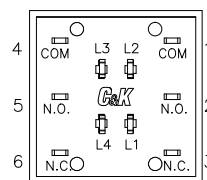
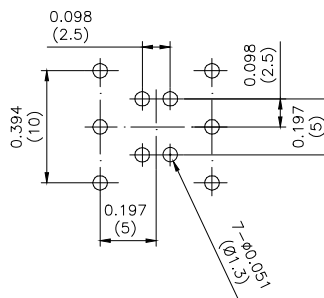
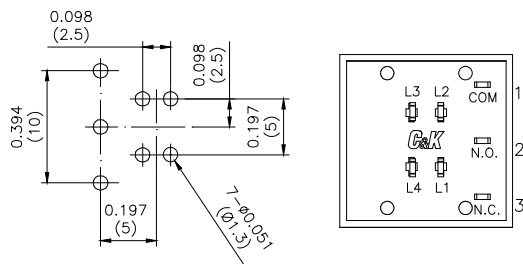

RGB



First Angle Projection



NEW

KLS Illuminated SPDT/DPDT Pushbutton



A
Pushbutton

LED CIRCUIT

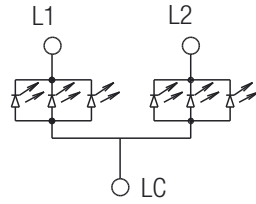

DUAL COLOUR

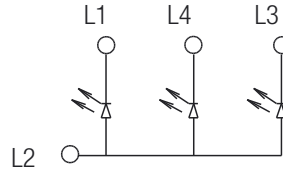

RGB

CONTACT MATERIAL

OPTION CODE	CONTACT MATERIAL	TERMINAL PLATING	RATING
Q	Copper / Gold ¹ Brass / Silver ²	Silver	25VDC 500 mA
G	Copper, Gold	Copper, Gold	28 VDC 100 mA

¹ Movable contact

² Stationary contact

X-ON Electronics

Largest Supplier of Electrical and Electronic Components

Click to view similar products for [Pushbutton Switches](#) category:

Click to view products by [C&K](#) manufacturer:

Other Similar products are found below :

[8940K2012](#) [8971K1133](#) [LW1L-M1C10V-A](#) [LW1L-M1C70-A](#) [LW2L-A1C20M-GD](#) [LW2L-M1C20M-A](#) [M22-D-R-GB0/K11](#) [M7E-HRN2](#)
[67081K512X](#) [701PB580](#) [7199K101](#) [810K12910](#) [810KSV30B](#) [MML21EA2ADK](#) [MML21KA3ABK](#) [MML23KA3AC05K-001](#)
[MML23KW3AA01W](#) [8418K2](#) [8442K3](#) [8450K1](#) [860K11911T01A](#) [861901](#) [861K11911T01A07](#) [861K13810T00A14](#) [861K13911](#)
[8646AB6X718UL](#) [8646ABUL](#) [9001KXRK](#) [907AYY100](#) [PMHD155A1](#) [9533CD4+U574+U4922](#) [95-414.000](#) [99-450.837](#) [99-453.837](#)
[PV3H2B0NN-341](#) [1203MRA](#) [A22NZBGANGA](#) [A22NZBNANGA](#) [A22NZMPATRA](#) [A2PMA1X03EC56](#) [A3A-5123-02](#) [A3A-7140](#) [A3A-](#)
[7310](#) [A3A-7340](#) [A3U-TMW-A2C-5M](#) [A595](#) [12037A2ULCSA](#) [1203A2UL](#) [ABD122N-B](#) [ABGW410-R](#)