

# LCS Series Subminiature Sealed Snap-acting Switches



UL61058-1  

## Features/Benefits

- Compact design
- Long life and high electrical capacity
- Quick connect, solder terminals, PC terminals, wire leads
- Wide variety of actuator styles
- RoHS compatible, RoHS compliant
- IP67

## Typical Applications

- Motorized equipment
- Sump pump
- Thermostatic controls
- Computers
- Air conditioners

## Specifications

CONTACT RATING: from low level to 5 Amp  
 ELECTRICAL LIFE: 10,000 cycles  
 INSULATION RESISTANCE: 100 M ohm min.  
 DIELECTRIC STRENGTH: 1,000 VAC  
 OPERATING TEMPERATURE:  
 -40°C to +120°C (without wire)  
 -40°C to +85°C (with UL1007 wire)  
 -40°C to +105°C (with UL1015 wire)  
 -40°C to +105°C (with UL1430 wire)  
 -40°C to +80°C (with UL1061 wire)  
 -40°C to +120°C (with UL1330 wire)  
 OPERATING FORCE: (see ACTUATOR'S option sections).  
 MOUNTING: 2-56 screws, torque 2.3 in/lbs max.

## Materials



SWITCH HOUSING: Thermoplastic polyester or high temperature thermoplastic (PTS) (UL 94V-0).  
 ACTUATOR BUTTON: Thermoplastic polyester.  
 SPRING: Copper alloy.  
 PIVOT: Copper alloy.  
 MOVABLE CONTACTS: Option "01" Gold plating over silver alloy  
 Option "05" Silver alloy  
 STATIONARY CONTACTS: Option "01" Gold plating over silver alloy  
 Option "05" Silver alloy  
 TERMINALS: Copper alloy.  
 ACTUATOR LEVEL: Stainless steel.

**NOTE:** Specifications and materials listed above are for switches with standard options.  
 For information on specific and custom switches, consult Customer Service center.

Snap-acting

## Build-A-Switch

To order, simply select desired option from each category and place in the appropriate box. Available options are shown and described on pages J-40 thru J-43. For additional options not shown in catalog, consult Customer Service Center.

<div style="display: flex; align-items: center; gap: 10px;"> <span style="border: 1px solid black; padding: 2px;">L</span> <span style="border: 1px solid black; padding: 2px;">C</span> <span style="border: 1px solid black; padding: 2px;">S</span> <span style="border: 1px solid black; padding: 2px;"> </span> <span style="border: 1px solid black; padding: 2px;"> </span> <span style="border: 1px solid black; padding: 2px;"> </span> <span style="border: 1px solid black; padding: 2px;"> </span> <span style="border: 1px solid black; padding: 2px;"> </span> <span style="border: 1px solid black; padding: 2px;"> </span> <span style="border: 1px solid black; padding: 2px;"> </span> <span style="border: 1px solid black; padding: 2px;"> </span> <span style="border: 1px solid black; padding: 2px;"> </span> <span style="border: 1px solid black; padding: 2px;"> </span> </div>		
<b>Series</b> LCS		
<b>Electrical Rating</b>		
<b>Option Code</b> 01 05	 UL 61058-1	 NA 6 A 250 V AC
<b>Operating Force</b> 2 203 grams		
<b>Actuator</b> P00 Pin plunger T00 11.9 mm short lever T05 17.4 mm short lever T07 19.4 mm short lever T13 25.5 mm lever T19 33.3 mm lever T28 40.7 mm lever T43 55.9 mm lever S26 18.6 mm simulated lever A05 17.2 mm lever roller		
<b>Terminations</b> S Solder Q 0.110 Quick Connect P PC Thru Hole W Wire leads potted Z Wire leads non-potted		
<b>Wire Type AWG (when required)</b> 20 20 AWG 22 22 AWG 24 24 AWG 26 26 AWG		
<b>Wire UL # (when required)</b> A UL1007 B UL1015 C UL1430 D UL1061		
<b>Wire Side (when required)</b> A Wire out the bottom B Wire out the right side C Wire out the left side D None		
<b>Circuitry</b> C SPDT W SPST N.C. Y SPST N.O.		



Dimensions are shown: mm  
 Specifications and dimensions subject to change

# LCS Series Subminiature Sealed Snap-acting Switches

## SERIES

**LCS**

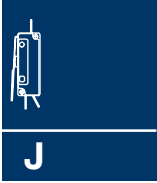
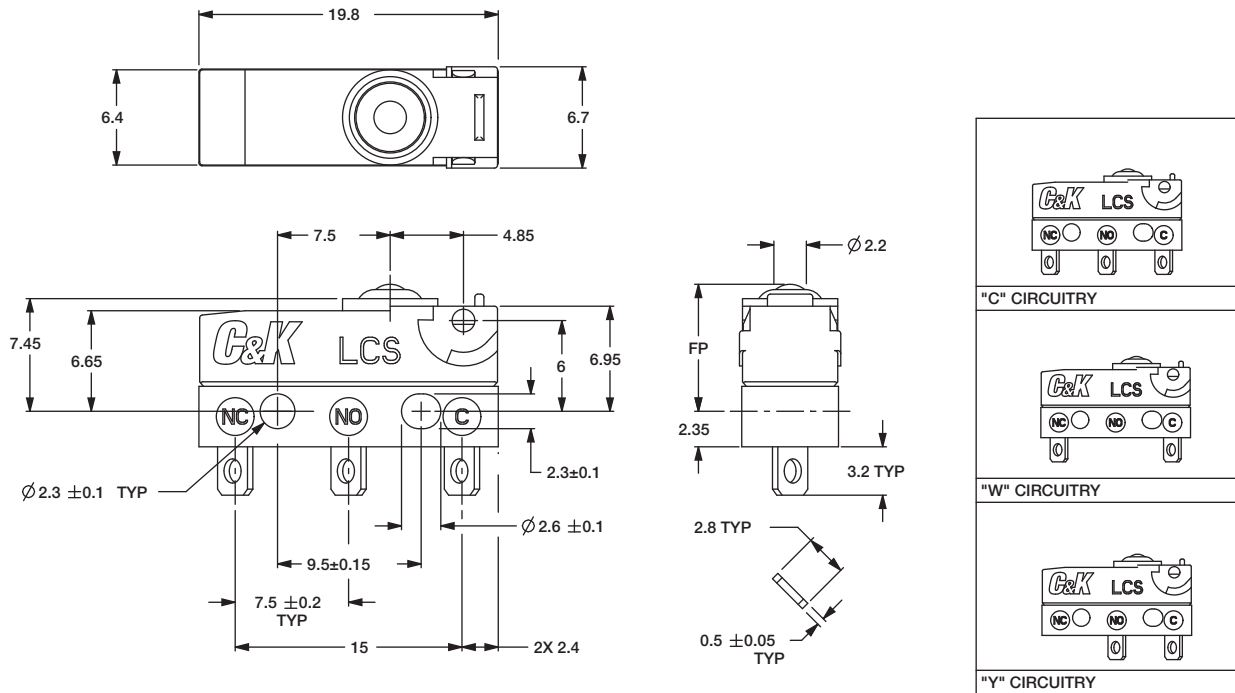

**Snap-acting**

## ELECTRICAL RATING

RoHS COMPLIANT *	RoHS COMPATIBLE *	OPTION CODE	ELECTRICAL RATING
YES	YES	<b>05</b>	5 AMP, 125/250 V AC
YES	YES	<b>01</b>	0.1 AMP, 125/250 V AC

## OPERATING FORCE

OPTION CODE	OPERATING FORCES (grams)
<b>2</b>	203 g. max.

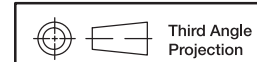

*Dimensions are shown: mm  
Specifications and dimensions subject to change*

# LCS Series Subminiature Sealed Snap-acting Switches

ACTUATOR 

P00

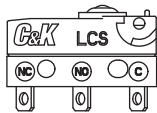

T00

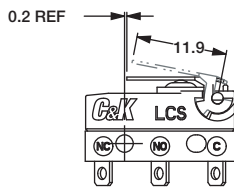

T05

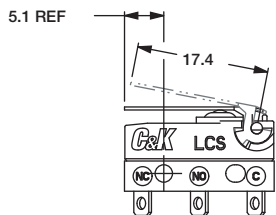

T19

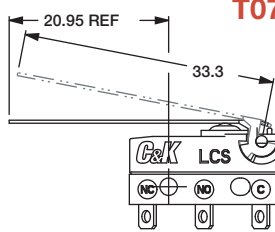

T28

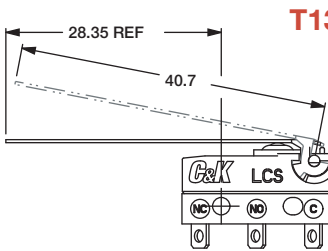

T43

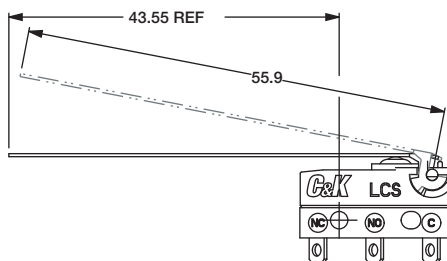

T07

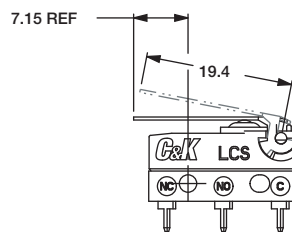

T13

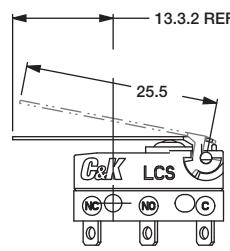

A05

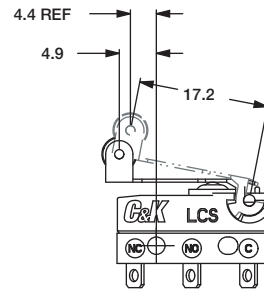

S26

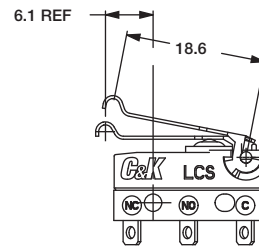

Snap-acting

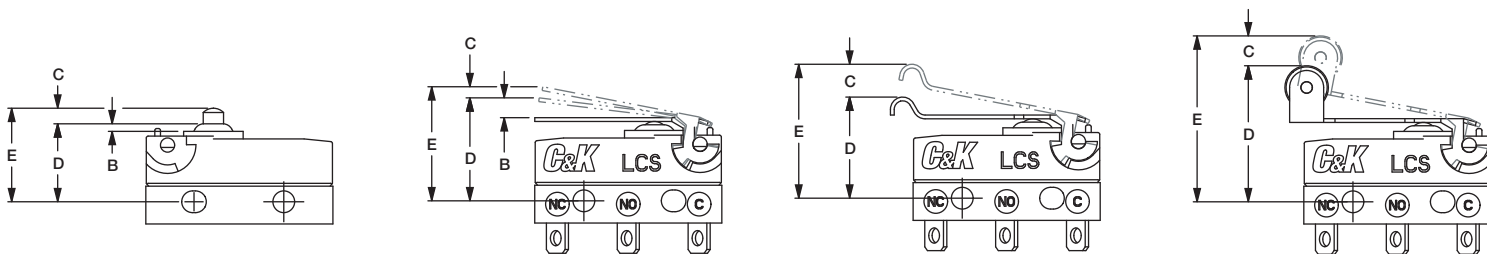

ACTUATOR OPTION CODE	A	B	C	D	E	DIFFERENTIAL MOTION (MAX)	OPERATING FORCE (MAX)	RELEASE FORCE (MIN)
	LENGTH OF LEVER	OVER TRAVEL (MIN)	PRE TRAVEL (MAX)	OPERATING POSITION	FREE POSITION (MAX)	203	203	203
P00	N/A	0.6	1.2	8.4 ± 0.3	9.9	0.2	203	50
T00	11.9	0.6	3.2	8.8 ± 0.9	11.1	0.5	98	21
T05	17.40	0.9	4.3	8.8 ± 1.1	12	0.6	82	16
T07	19.40	1	4.8	8.8 ± 1.2	12.4	0.7	66	13
T13	25.5	1.6	6.3	8.8 ± 1.6	13.5	0.9	54	11
T19	33.3	1.95	8	8.8 ± 2.0	15	1.75	40	5
T28	40.7	2.1	10.1	8.8 ± 2.6	16.3	2.3	39	8
T43	55.9	2.9	13.8	8.8 ± 3.5	19.1	3.6	33	7
S26	18.6	1	4.6	10.7 ± 1.2	14.1	0.65	68	14
A05	17.20	0.9	4.3	14.5 ± 1.1	17.7	0.6	72	15



Third Angle  
Projection  
Dimensions are shown: mm  
Specifications and dimensions subject to change



# LCS Series Subminiature Sealed Snap-acting Switches

## TERMINATIONS

### S SOLDER

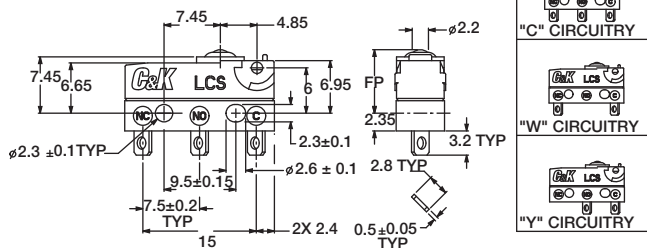

### Q QUICK CONNECT 2.8mm / 0.110"

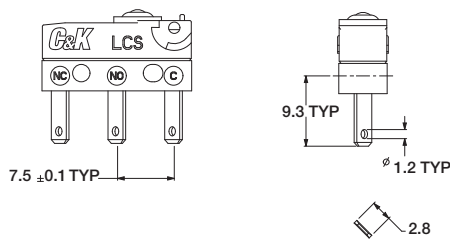

### P PC THRU HOLE

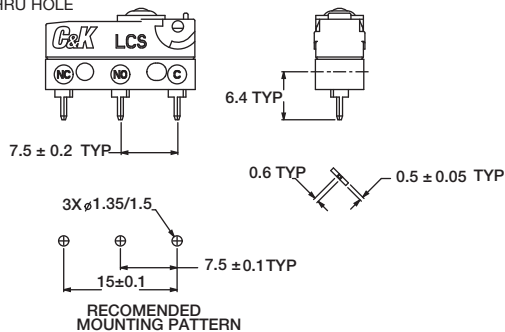

### Z or W "A" WIRE ORIENTATION

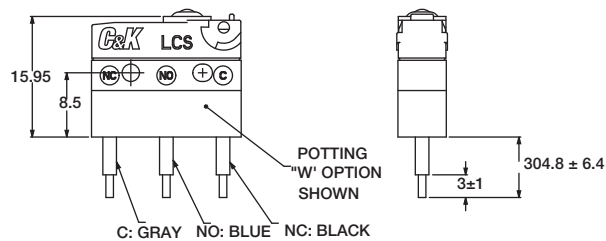

### Z or W "B" WIRE ORIENTATION "Y" OR "W" CIRCUITRY

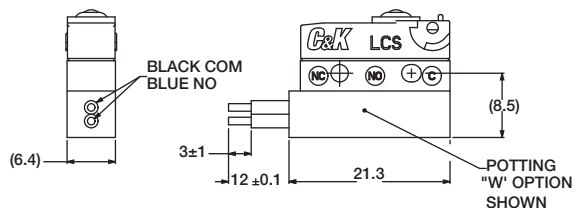

### Z or W "C" WIRE ORIENTATION "Y" OR "W" CIRCUITRY

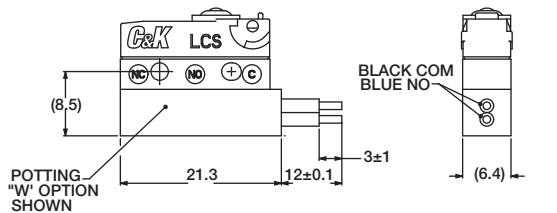

### Z or W "B" WIRE ORIENTATION "C" CIRCUITRY

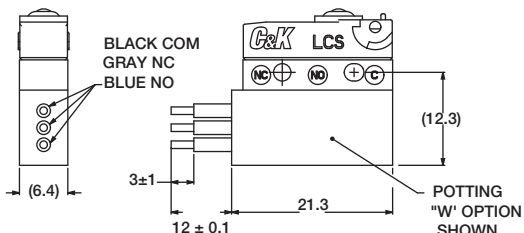

### Z or W "C" WIRE ORIENTATION "C" CIRCUITRY

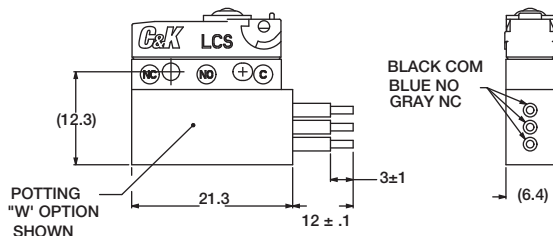

## CIRCUITRY

- C** SPDT (Single Pole, Double Throw)
- W** SPST N.C. (Single Pole, Single Throw, Normally Closed)
- Y** SPST N.O. (Single Pole, Single Throw, Normally Open)



Third Angle  
Projection

Dimensions are shown: mm  
Specifications and dimensions subject to change

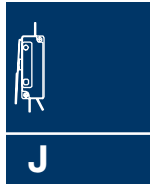

Snap-acting

## X-ON Electronics

Largest Supplier of Electrical and Electronic Components

*Click to view similar products for [Basic / Snap Action Switches](#) category:*

*Click to view products by [C&K](#) manufacturer:*

Other Similar products are found below :

[83228001](#) [01.098.1358.1](#) [602EN1-6B](#) [602EN532](#) [602EN535-RB](#) [602HE5-RB1](#) [604HE162](#) [604HE223-6B](#) [624HE17-RB](#) [6HM89](#) [6PA78-JM](#)  
[6SE1](#) [6SX1-H58](#) [70500840](#) [MBD5B1](#) [MBH2731](#) [73-316-0012](#) [79211759](#) [79211923](#) [79218589](#) [7AS12](#) [ML-1155](#) [ML-1376](#) [831010C3.0](#)  
[831060C3.TL](#) [831090C2.EL](#) [83131904](#) [84212012](#) [8AS239](#) [8HM73-3](#) [903VB1-PG](#) [914CE1-6G](#) [PL-100](#) [11SM1077-H4](#) [11SM1077-H58](#)  
[11SM1-TN107](#) [11SM405](#) [11SM703-T](#) [11SM8423-H2](#) [11SX37-T](#) [11SX48-H58](#) [11SX55-H58](#) [11SM2442-T](#) [11SM76-T](#) [11SM77-H58](#)  
[11SM77-T](#) [11SM863-T](#) [11SM866](#) [11SX47-H58](#) [A7CN-1M-1-LEFT](#)