

LCS Series Small Size Sealed Snap-acting Switches



UL61058-1



Features/Benefits

- Compact design
- Long life and high electrical capacity
- Quick connect, solder terminals, PC terminals, wire leads
- Wide variety of actuator styles
- RoHS compatible, RoHS compliant
- IP67 for standalone switch except the metal terminal part; Full IP67 protection when potted with wire version

Typical Applications

- Motorized equipment
- Sump pump
- Thermostatic controls
- Computers
- Air conditioners
- Automotive: door latch, seat position detection, EV charging

Specifications

CONTACT RATING: from low level to 5 Amp
 ELECTRICAL LIFE: 10,000 cycles for 5A; 1M cycles for 0.1A
 INSULATION RESISTANCE: 100 M ohm min.
 DIELECTRIC STRENGTH: 1,000 VAC
 OPERATING TEMPERATURE:
 -40°C to +120°C (without wire)
 -40°C to +85°C (with UL1007 wire)
 -40°C to +105°C (with UL1015 wire)
 -40°C to +105°C (with UL1430 wire)
 -40°C to +80°C (with UL1061 wire)
 -40°C to +120°C (with UL1330 wire)
 OPERATING FORCE: (see ACTUATOR'S option sections).
 MOUNTING: 2-56 screws, torque 2.3 in/lbs max.

Materials

SWITCH HOUSING: Thermoplastic polyester or high temperature thermoplastic (PTS) (UL 94V-0).
 ACTUATOR BUTTON: Thermoplastic polyester.
 SPRING: Copper alloy.
 PIVOT: Copper alloy.
 MOVABLE CONTACTS: Option "01" Gold plating over silver alloy
 Option "05" Silver alloy
 STATIONARY CONTACTS: Option "01" Gold plating over silver alloy
 Option "05" Silver alloy
 TERMINALS: Copper alloy.
 ACTUATOR LEVEL: Stainless steel.

NOTE: Specifications and materials listed above are for switches with standard options.
 For information on specific and custom switches, consult Customer Service center.

Build-A-Switch

To order, simply select desired option from each category and place in the appropriate box. For additional options not shown in catalog, consult Customer Service Center.

<div style="display: flex; align-items: center; gap: 10px;"> L C S </div>														
Series LCS			Electrical Rating		Operating Force 2 203 grams		Actuator *		Terminations		Wire Type AWG (when required)		Wire UL # (when required)	
Option Code		UL 61058-1			P00 Pin plunger T00 11.9 mm short lever T05 17.4 mm short lever T07 19.4 mm short lever T13 25.5 mm lever T19 33.3 mm lever T28 40.7 mm lever T43 55.9 mm lever S26 18.6 mm simulated lever A05 17.2 mm lever roller		S Solder Q 0.110 Quick Connect P PC Thru Hole W Wire leads potted Z Wire leads non-potted		20 20 AWG 22 22 AWG 24 24 AWG 26 26 AWG		A UL1007 B UL1015 C UL1430 D UL1061			
01	0.1 A 125/250 V AC		NA											
05	5 A 125/250 V AC		6 A 250 V AC											

* Dim. A
 See chart on following pages for detailed information

Wire Side (when required)

- A** Wire out the bottom
- B** Wire out the right side
- C** Wire out the left side
- D** None

Dimensions are shown: mm
 Specifications and dimensions subject to change



LCS Series Small Size Sealed Snap-acting Switches

SERIES

LCS

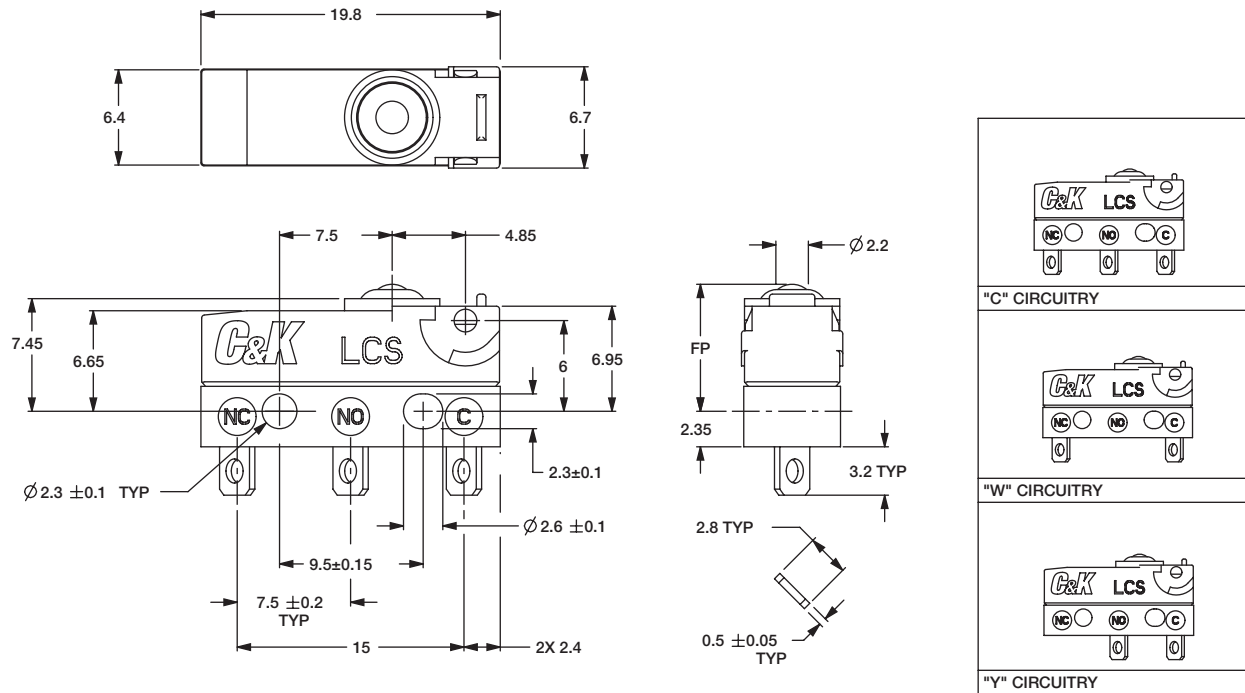

Snap-acting

ELECTRICAL RATING

RoHS COMPLIANT *	RoHS COMPATIBLE *	OPTION CODE	ELECTRICAL RATING
YES	YES	05	5 AMP, 125/250 V AC
YES	YES	01	0.1 AMP, 125/250 V AC

OPERATING FORCE

OPTION CODE	OPERATING FORCES (grams)
2	203 g. max.

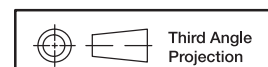

Dimensions are shown: mm
Specifications and dimensions subject to change



31 May 21

LCS Series Small Size Sealed Snap-acting Switches

ACTUATOR

P00

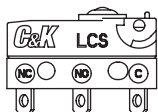

T19

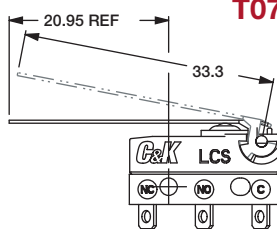

T07

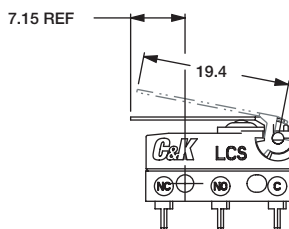

A05

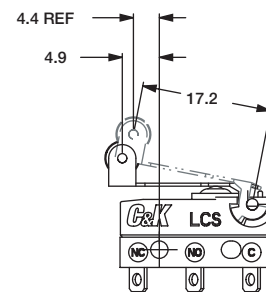

T00

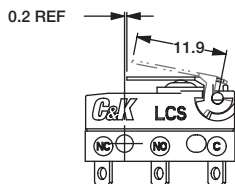

T28

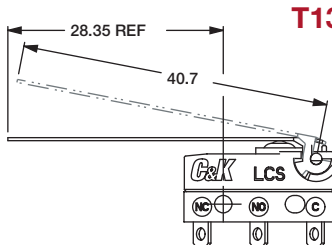

T13

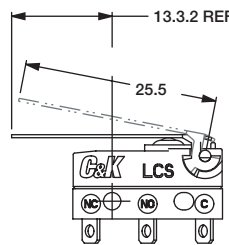

S26

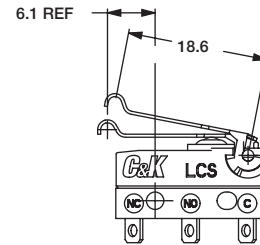

T05

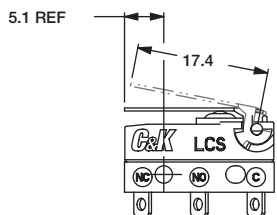

T43

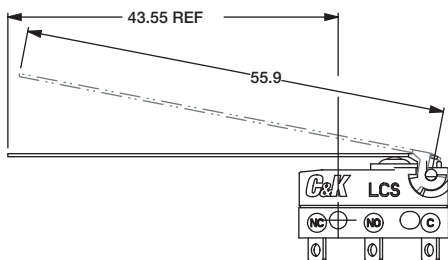

Snap-acting

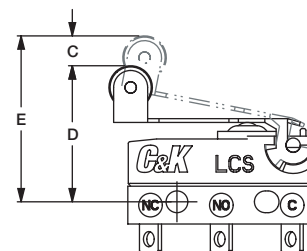
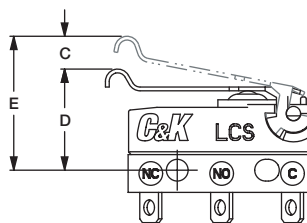
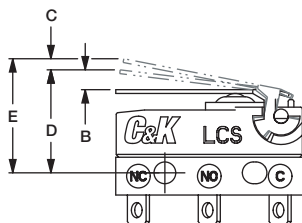
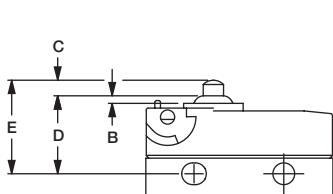

ACTUATOR OPTION CODE	A LENGTH OF LEVER	B OVER TRAVEL (MIN)	C PRE TRAVEL (MAX)	D OPERATING POSITION	E FREE POSITION (MAX)	DIFFERENTIAL MOTION (MAX)	OPERATING FORCE (MAX)	RELEASE FORCE (MIN)
P00	N/A	0.6	1.2	8.4 ± 3	9.9	0.2	203	50
T00	11.9	0.6	3.2	8.8 ± 9	11.1	0.5	98	21
T05	17.40	0.9	4.3	8.8 ± 1.1	12	0.6	82	16
T07	19.40	1	4.8	8.8 ± 1.2	12.4	0.7	66	13
T13	25.5	1.6	6.3	8.8 ± 1.6	13.5	0.9	54	11
T19	33.3	1.95	8	8.8 ± 2.0	15	1.75	40	5
T28	40.7	2.1	10.1	8.8 ± 2.6	16.3	2.3	39	8
T43	55.9	2.9	13.8	8.8 ± 3.5	19.1	3.6	33	7
S26	18.6	1	4.6	10.7 ± 1.2	14.1	0.65	68	14
A05	17.20	0.9	4.3	14.5 ± 1.1	17.7	0.6	72	15

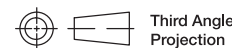

Third Angle Projection
Dimensions are shown: mm
Specifications and dimensions subject to change



LCS Series Small Size Sealed Snap-acting Switches

TERMINATIONS

S SOLDER

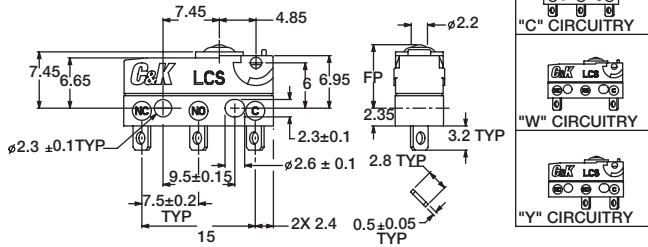

Q QUICK CONNECT 2.8mm / 0.110"

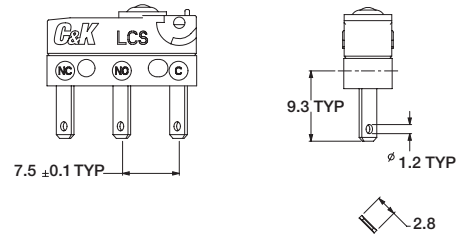

P PC THRU HOLE

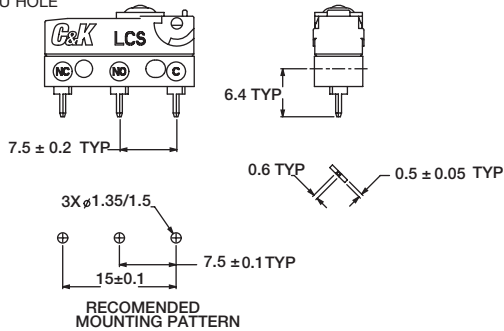

Z or W "A" WIRE ORIENTATION

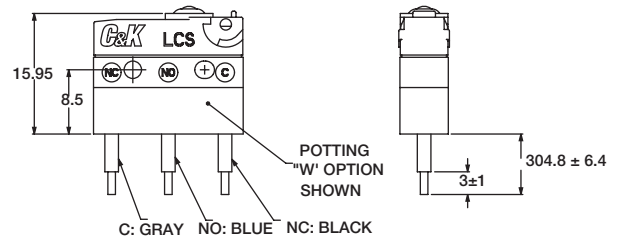

Z or W "B" WIRE ORIENTATION "Y" OR "W" CIRCUITRY

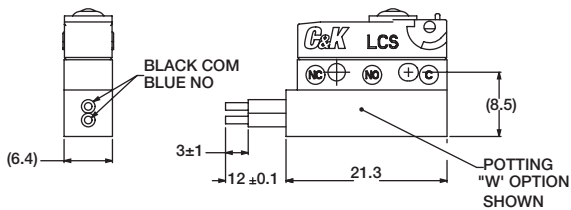

Z or W "C" WIRE ORIENTATION "Y" OR "W" CIRCUITRY

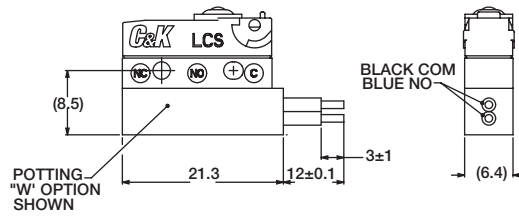

Z or W "B" WIRE ORIENTATION "C" CIRCUITRY

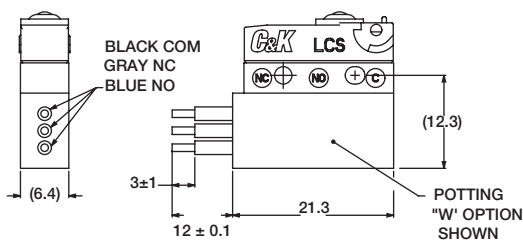

Z or W "C" WIRE ORIENTATION "C" CIRCUITRY

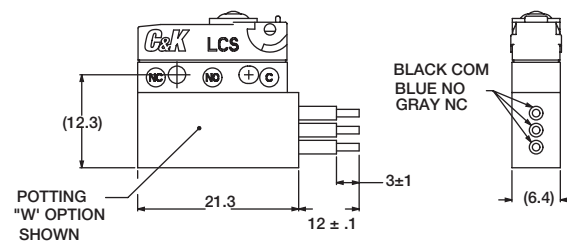

Snap-acting

CIRCUITRY

- C** SPDT (Single Pole, Double Throw)
- W** SPST N.C. (Single Pole, Single Throw, Normally Closed)
- Y** SPST N.O. (Single Pole, Single Throw, Normally Open)

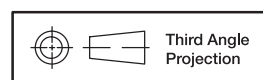

Dimensions are shown: mm
Specifications and dimensions subject to change



X-ON Electronics

Largest Supplier of Electrical and Electronic Components

Click to view similar products for [Basic / Snap Action Switches](#) category:

Click to view products by [C&K](#) manufacturer:

Other Similar products are found below :

[5SM901-S12](#) [5SM9-S12N195](#) [602EN532](#) [602EN535-RB](#) [602HE5-RB1](#) [604HE162](#) [604HE223-6B](#) [624HE17-RB](#) [6HM82](#) [6HM89](#) [6SE1](#)
[6SX1-H58](#) [70500216](#) [70599106](#) [MBD5B1](#) [MBH2731](#) [73-316-0012](#) [EXD-AR20](#) [79211923](#) [79218589](#) [7AS12](#)
[MIL30126AB6BBMD4A12XAU](#) [ML-1155](#) [ML-1376](#) [831010C3.0](#) [831090C2.EL](#) [83131904](#) [84212012](#) [8AS239](#) [8HM73-3](#) [8SX26-H33](#)
[914CE1-6G](#) [PL-100](#) [11SM1077-H4](#) [11SM1077-H58](#) [11SM1-TN107](#) [11SM405](#) [11SM8423-H2](#) [11SX37-T](#) [11SX48-H58](#) [11SM2442-T](#)
[11SM76-T](#) [11SM77-H58](#) [11SM77-T](#) [11SM863-T](#) [11SM866](#) [A7CN-1M-1-LEFT](#) [A831700C7.0](#) [121EN188-R](#) [1245.0120](#)