

# MIL 24308 Class M Series

## D\*M – D\*MA connectors and crimp contacts

### Features/Benefits

- **D\*MA (Removable crimp contacts technology) : QPL listed MIL 24308 class M Connectors**
- **D\*M (Solder bucket) : QPL listed MIL 24308 class M Connectors**
- **D\*M (90°PCB) : QPL listed MIL 24308 class M Connectors**
- **Non-Magnetic (NMB class)**
- **Non-Outgassing**
- **From 9 to 50 ways (D\*M and D\*MA standard density)**
- **From 15 to 78 ways (D\*MA high density)**

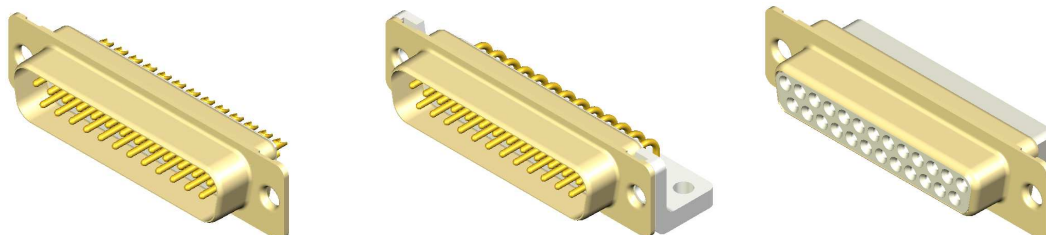

### Typical Applications

- **Space flight equipment**
- **Satellite structure, payload, harnesses**
- **Launcher application**

### Specification

High performance D\*Sub connectors meet stringent tests for outgassing and residual magnetism and are suitable for use in Space flight applications.

Suitable for Board to Board, Board to Cable or Cable to Cable applications.

Sizes available Standard density : 9, 15, 25, 37 and 50 ways

Sizes available High density : 15, 26, 44, 62, 78 ways

Pin and Socket arrangements available

Removable contacts (D\*MA type)

### C&K QPL listed components :

D\*MA (Removable crimp contacts) :

MIL-DTL-24308/6 : Connectors D\*MA Standard and High Density ,Receptacle, Without contacts.

MIL-DTL-24308/8 : Connectors D\*MA Standard and High Density, Plug, Without contacts..

D\*M (Solder type contacts) :

MIL-DTL-24308/5 : Connectors D\*M Standard density, Receptacle, Socket contacts, Solder type.

MIL-DTL-24308/7 : Connectors D\*M Standard density , Pug, Pin contacts, Solder type.

D\*M (Printed Wiring Board termination type):

MIL-DTL-24308/23 : Connectors D\*M Standard density, Receptacle, Socket contacts, 90°PCB type.

MIL-DTL-24308/24 : Connectors D\*M Standard density, Plug, Pin contacts, 90°PCB type.

### Electrical & Mechanical Characteristics

As per defined in the MIL-DTL-24308 specification :

- **Contact insertion and removal forces** : contact size 20 or 22, insertion or removal : 17.79 N (4 pounds) max.
- **Contact retention in insert** : 40 N max (9 pounds) contact axial displacement 0.30mm (.012 inch) max.
- **Current rating : Contact type 20** : rated current (A max : 7.5. Contact resistance Mv max : 55.
- **Insulation resistance** : 5000 M ohms min at 500 V dc.
- **Magnetic permeability** : Relative permeability 2µm max..
- **Operating Temperature** : -55°C to +125°C (-67°F to 257°F)
- **Dielectric withstanding voltage** : (volts rms, 60Hz) Humidity conditioned sea level : 600. All other conditions sea level : 1000 , 70 000 feet : 325.

### Packaging

Individual packaging.  
Traceability associated



Dimensions shown in: mm (inch)  
Specifications and dimensions subject to change

# MIL 24308 Class M Series

## D\*M – D\*MA connectors and crimp contacts

### How To Order Connectors :

- For any part number different from those listed above, please consult your local C&K components representative.

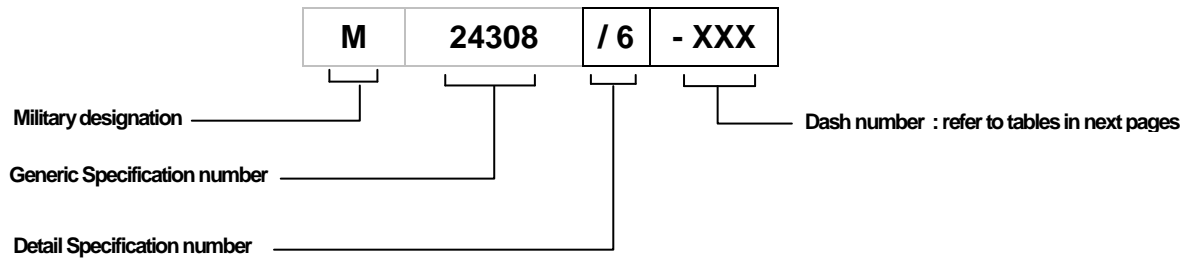

- /5: Connectors D\*M Standard density, Receptacle, Socket contacts, Solder type
- /6: Connectors D\*MA Standard and High Density ,Receptacle, Without contacts.
- /7: Connectors D\*M Standard density , Pug, Pin contacts, Solder type
- /8: Connectors D\*MA Standard and High Density, Plug, Without contacts.
- /23: Connectors D\*M Standard density, Receptacle, Socket contacts, 90° PCB type
- /24: Connectors D\*M Standard density, Plug, Pin contacts, 90° PCB type

# MIL 24308 Class M Series D\*M – D\*MA connectors and crimp contacts

## Connectors D\*M Solder bucket - MIL Designation and C&K Part Numbers

Type	Nbr ways	Fixing Option			
		Standard		Float Mount (Y)	
		C&K Part Number	MIL Designation	C&K Part Number	MIL Designation
Solder Cup	9 P	C115372-2000B	M24308/7-23	C115372-2050B	M24308/7-39
	9 S	C115372-2001B	M24308/5-34	C115372-2051B	M24308/5-56
	15 P	C115372-2002B	M24308/7-24	C115372-2052B	M24308/7-40
	15 S	C115372-2003B	M24308/5-35	C115372-2053B	M24308/5-57
	25 P	C115372-2004B	M24308/7-25	C115372-2054B	M24308/7-41
	25 S	C115372-2005B	M24308/5-36	C115372-2055B	M24308/5-58
	37 P	C115372-2006B	M24308/7-26	C115372-2056B	M24308/7-42
	37 S	C115372-2007B	M24308/5-37	C115372-2057B	M24308/5-59
	50 P	C115372-2008B	M24308/7-27	C115372-2058B	M24308/7-43
50 S	C115372-2009B	M24308/5-38	C115372-2059B	M24308/5-60	

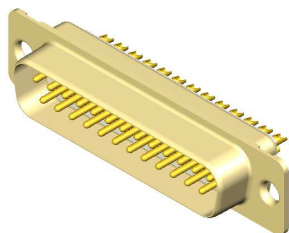

## Connectors D\*M for PCB - MIL Designation and C&K Part Numbers

Type	Nbr ways	"D" Termination type		"L" Termination type		"S" Termination type	
		C&K Part Number	MIL Designation	C&K Part Number	MIL Designation	C&K Part Number	MIL Designation
90° PCB terminations	9 P	C115372-2100B	M24308/24-125	C115372-2110B	M24308/24-131	C115372-2140B	M24308/24-149
	9 S	*	*	C115372-2111B	M24308/23-131	C115372-2141B	M24308/23-149
	15 P	C115372-2102B	M24308/24-126	C115372-2112B	M24308/24-132	C115372-2142B	M24308/24-150
	15 S	*	*	C115372-2113B	M24308/23-132	C115372-2143B	M24308/23-150
	25 P	C115372-2104B	M24308/24-127	C115372-2114B	M24308/24-133	C115372-2144B	M24308/24-151
	25 S	*	*	C115372-2115B	M24308/23-133	C115372-2145B	M24308/23-151
	37 P	C115372-2106B	M24308/24-128	C115372-2116B	M24308/24-134	C115372-2146B	M24308/24-152
	37 S	*	*	C115372-2117B	M24308/23-134	C115372-2147B	M24308/23-152
	50 P	C115372-2108B	M24308/24-129	C115372-2118B	M24308/24-135	C115372-2148B	M24308/24-153
50 S	*	*	C115372-2119B	M24308/23-135	C115372-2149B	M24308/23-153	

\* Available on request, please consult your local C&K components representative.

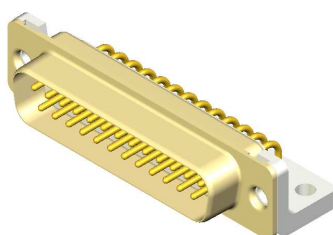

Dimensions shown in: mm (inch)  
Specifications and dimensions subject to change

# MIL 24308 Class M Series

## D\*M – D\*MA connectors and crimp contacts

### Connectors D\*MA Removable contacts, Standard density : MIL Designation and C&K Part Numbers

Type	Nbr ways	Fixing Option			
		Standard		Float Mount (Y)	
		C&K Part Number	MIL Designation	C&K Part Number	MIL Designation
Without Contacts	9 P	C115370-1710B	M24308/8-357	C115370-1730B	M24308/8-423
	9 S	C115370-1711B	M24308/6-540	C115370-1731B	M24308/6-573
	15 P	C115370-1712B	M24308/8-358	C115370-1732B	M24308/8-424
	15 S	C115370-1713B	M24308/6-541	C115370-1733B	M24308/6-574
	25 P	C115370-1714B	M24308/8-359	C115370-1734B	M24308/8-425
	25 S	C115370-1715B	M24308/6-542	C115370-1735B	M24308/6-575
	37 P	C115370-1716B	M24308/8-360	C115370-1736B	M24308/8-426
	37 S	C115370-1717B	M24308/6-543	C115370-1737B	M24308/6-576
	50 P	C115370-1718B	M24308/8-361	C115370-1738B	M24308/8-427
	50 S	C115370-1719B	M24308/6-544	C115370-1739B	M24308/6-577



### Connectors D\*MA Removable contacts, High density : MIL Designation and C&K Part Numbers

Type	Nbr ways	Fixing Option			
		Standard		Float Mount (Y)	
		C&K Part Number	MIL Designation	C&K Part Number	MIL Designation
Without Contacts	15 P	C115368-1610B	M24308/8-362	C115368-1630B	M24308/8-428
	15 S	C115368-1611B	M24308/6-545	C115368-1631B	M24308/6-578
	26 P	C115368-1612B	M24308/8-363	C115368-1632B	M24308/8-429
	26 S	C115368-1613B	M24308/6-546	C115368-1633B	M24308/6-579
	44 P	C115368-1614B	M24308/8-364	C115368-1634B	M24308/8-430
	44 S	C115368-1615B	M24308/6-547	C115368-1635B	M24308/6-580
	62 P	C115368-1616B	M24308/8-365	C115368-1636B	M24308/8-431
	62 S	C115368-1617B	M24308/6-548	C115368-1637B	M24308/6-581
	78 P	C115368-1618B	M24308/8-366	C115368-1638B	M24308/8-432
	78 S	C115368-1619B	M24308/6-549	C115368-1639B	M24308/6-582



## Materials & Finishes

COMPONENT	MATERIAL	FINISH
Shell	Annealed brass	1.27 µm min Gold over Copper
Insulator	Thermoplastic Polyester	UL 94-V0, Glass-filled, Natural Color
Female Contacts	Copper Alloy	1.27 µm min Gold over Copper
Male Contacts	Copper Alloy	1.27 µm min Gold over Copper
Bracket	Thermoplastic Polyester	UL 94-V0, Glass-filled, Natural Color



Dimensions shown in: mm (inch)  
Specifications and dimensions subject to change

# MIL 24308 Class M Series

## D\*M – D\*MA connectors and crimp contacts

### Connectors Dimensions

#### Connectors shell dimensions - Plug

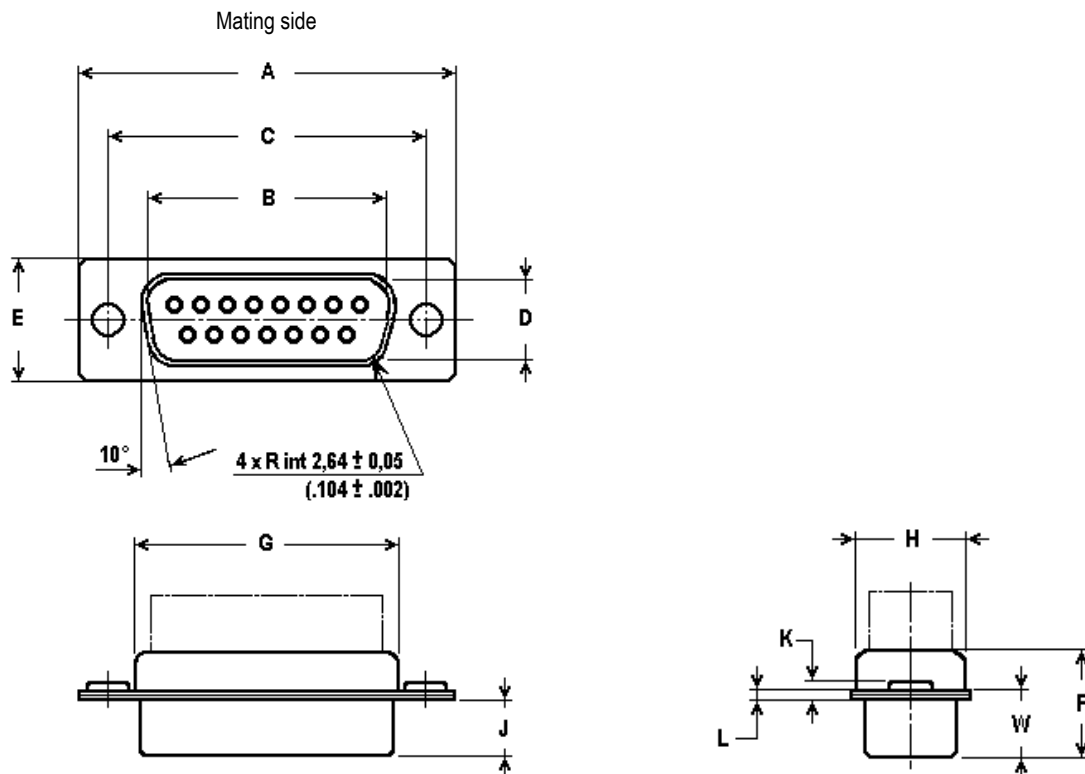

Shell Size mm	A ± 0,38	B ± 0,13	C ± 0,13	D ± 0,13	E ± 0,38	F ± 0,25	G ± 0,25	H ± 0,25	W ±* / **	J ±* / **	K ±* / **	L ± 0,25
E	30,81	16,92	24,99	8,36	12,55	10,72	19,28	10,72	6,69 *	5,94 *	1,21 *	0,77
A	39,14	25,25	33,32	8,36	12,55	10,72	27,51	10,72	6,69 *	5,94 *	1,21 *	0,77
B	53,04	38,96	47,04	8,36	12,55	10,82	41,28	10,72	6,84 **	5,84 **	1,52 **	0,99
C	69,32	55,42	63,50	8,36	12,55	10,82	57,71	10,72	6,84 **	5,84 **	1,52 **	0,99
D	66,93	52,81	61,11	11,07	15,37	10,82	55,33	13,57	6,84 **	5,84 **	1,52 **	0,99

\* ± 0,37    \* ± 0,12    \* ± 0,32  
\*\* ± 0,41    \*\* ± 0,15    \*\* ± 0,25

Shell Size (inch)	A ± 0,015	B ± 0,005	C ± 0,005	D ± 0,005	E ± 0,015	F ± 0,010	G ± 0,010	H ± 0,010	W ±* / **	J ±* / **	K ±* / **	L ± 0,010
E	1.213	.666	.984	.329	.494	.422	.759	.422	.264 *	.234	.048 *	.030
A	1.541	.994	1.312	.329	.494	.422	1.083	.422	.264 *	.234	.048 *	.030
B	2.088	1.534	1.852	.329	.494	.426	1.625	.422	.269 **	.230	.060 **	.039
C	2.729	2.182	2.500	.329	.494	.426	2.272	.422	.269 **	.230	.060 **	.039
D	2.635	2.079	2.406	.436	.605	.426	2.178	.534	.269 **	.230	.060 **	.039

\* ± .015    \* ± .005    \* ± .013  
\*\* ± .016    \*\* ± .006    \*\* ± .010



*Dimensions shown in: mm (inch)  
Specifications and dimensions subject to change*

# MIL 24308 Class M Series

## D\*M – D\*MA connectors and crimp contacts

### Connectors shell dimensions - Receptacle

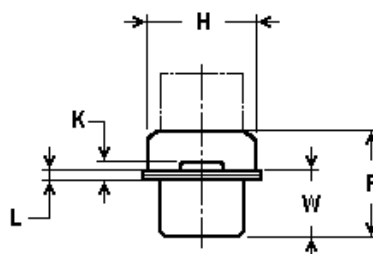
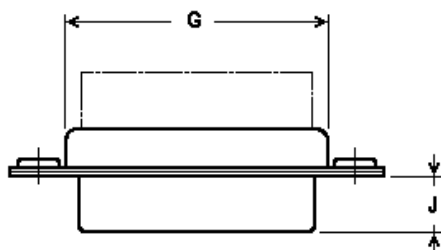
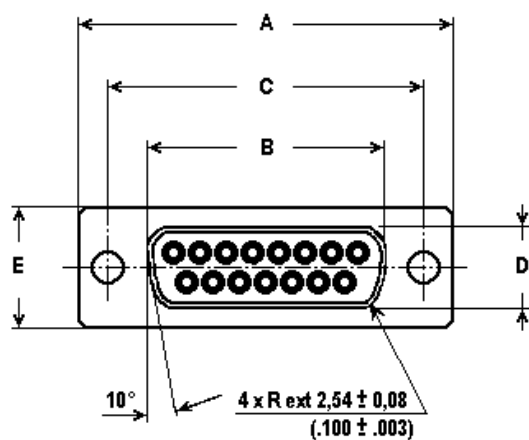

Shell Size	A	B	C	D	E	F	G	H	W	J	K	L
mm	± 0,38	± 0,13	± 0,13	± 0,13	± 0,38	± 0,25	± 0,25	± 0,25	± * / **	± * / **	± * / **	± 0,25
E	30,81	16,33	24,99	7,90	12,55	10,90	19,28	10,72	6,94	6,18	1,21	0,77
A	39,14	24,66	33,32	7,90	12,55	10,90	27,51	10,72	6,94	6,18	1,21	0,77
B	53,04	38,38	47,04	7,90	12,55	10,90	41,28	10,72	6,94	6,18	1,21	0,77
C	69,32	54,84	63,50	7,90	12,55	10,90	57,71	10,72	6,94	6,18	1,21	0,77
D	66,93	52,42	61,11	10,74	15,37	10,90	55,33	13,57	6,94	6,18	1,21	0,77

Shell Size	A	B	C	D	E	F	G	H	W	J	K	L
(inch)	± 0,015	± 0,005	± 0,005	± 0,005	± 0,015	± 0,010	± 0,010	± 0,010	± 0,015	± 0,005	± 0,013	± 0,010
E	1.213	.643	.984	.311	.494	.429	.759	.422	.273	.243	.048	.030
A	1.541	.971	1.312	.311	.494	.429	1.083	.422	.273	.243	.048	.030
B	2.088	1.511	1.852	.311	.494	.429	1.625	.422	.273	.243	.048	.030
C	2.729	2.159	2.500	.311	.494	.429	2.272	.422	.273	.243	.048	.030
D	2.635	2.064	2.406	.423	.605	.429	2.178	.534	.273	.243	.048	.030



*Dimensions shown in: mm (inch)  
Specifications and dimensions subject to change*

# MIL 24308 Class M Series

## D\*M – D\*MA connectors and crimp contacts

### Standard Density Contact Cavity Arrangements

Face view plug inserts (use a mirror image for receptacle inserts)

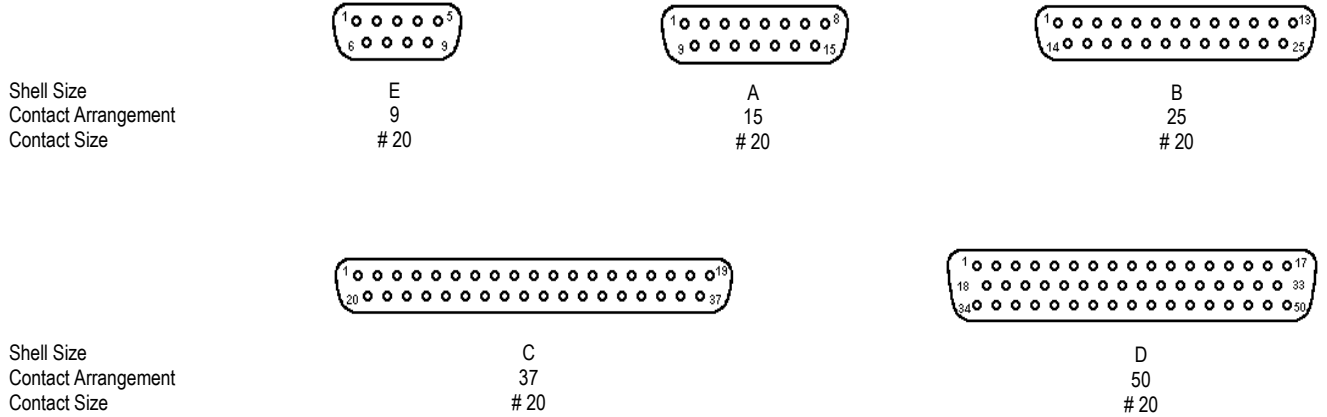

### High Density Contact Cavity Arrangements

Face view pin inserts (use a mirror image for receptacle inserts)

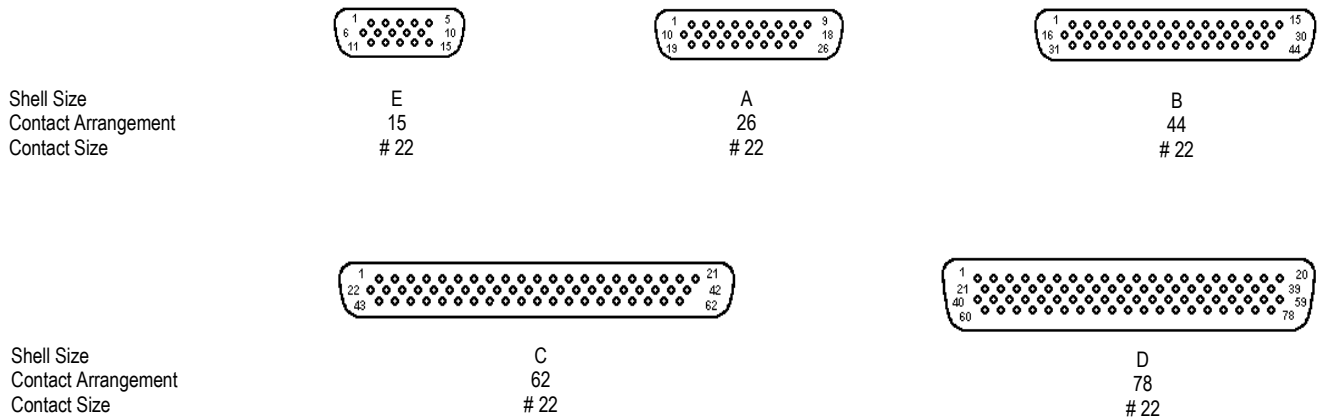

# MIL 24308 Class M Series

## D\*M – D\*MA connectors and crimp contacts

### Panel Cutouts

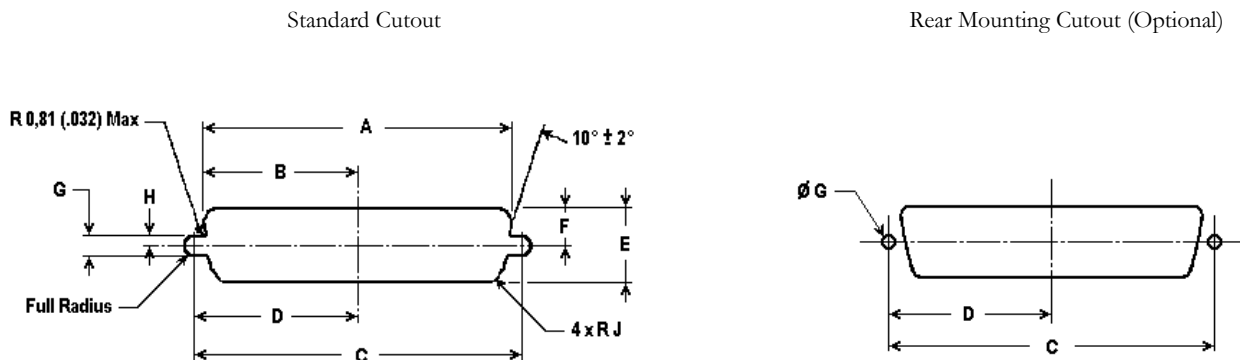

#### Standard Shell

Shell Size mm (inch)	Mounting Method	A ± 0,13 (.005)	B ± 0,13 (.005)	C ± 0,13 (.005)	D ± 0,13 (.005)	E ± 0,13 (.005)	F ± 0,13 (.005)	G ± 0,05 (.002)	H ± 0,05 (.002)	J ± 0,05 (.002)
E	Front	22,19 (.874)	11,09 (.437)	24,99 (.984)	12,49 (.492)	13,03 (.513)	6,52 (.257)	3,04 (.120)	1,52 (.060)	2,10 (.083)
E	Rear	20,47 (.806)	10,23 (.403)	24,99 (.984)	12,49 (.492)	11,40 (.449)	5,71 (.225)	3,04 (.120)	1,52 (.060)	3,35 (.132)
A	Front	30,53 (1.202)	15,26 (.601)	33,32 (1.312)	16,66 (.656)	13,03 (.513)	6,52 (.257)	3,04 (.120)	1,52 (.060)	2,10 (.083)
A	Rear	28,80 (1.134)	14,40 (.567)	33,32 (1.312)	16,66 (.656)	11,40 (.449)	5,71 (.225)	3,04 (.120)	1,52 (.060)	3,35 (.132)
B	Front	44,27 (1.743)	22,14 (.872)	47,04 (1.852)	23,52 (.926)	13,03 (.513)	6,52 (.257)	3,04 (.120)	1,52 (.060)	2,10 (.083)
B	Rear	42,51 (1.674)	21,25 (.837)	47,04 (1.852)	23,52 (.926)	11,40 (.449)	5,71 (.225)	3,04 (.120)	1,52 (.060)	3,35 (.132)
C	Front	60,73 (2.391)	30,37 (1.196)	63,50 (2.500)	31,75 (1.250)	13,03 (.513)	6,52 (.257)	3,04 (.120)	1,52 (.060)	2,10 (.083)
C	Rear	59,08 (2.326)	29,54 (1.163)	63,50 (2.500)	31,75 (1.250)	11,40 (.449)	5,71 (.225)	3,04 (.120)	1,52 (.060)	3,35 (.132)
D	Front	58,34 (2.297)	29,18 (1.149)	61,11 (2.406)	30,55 (1.203)	15,82 (.623)	7,92 (.312)	3,04 (.120)	1,52 (.060)	2,10 (.083)
D	Rear	56,33 (2.218)	28,16 (1.109)	61,11 (2.406)	30,55 (1.203)	14,09 (.555)	7,06 (.278)	3,04 (.120)	1,52 (.060)	3,35 (.132)

#### Dual Float Mount Shell

Shell Size mm (inch)	Mounting Method	A ± 0,13 (.005)	B ± 0,13 (.005)	C ± 0,13 (.005)	D ± 0,13 (.005)	E ± 0,13 (.005)	F ± 0,13 (.005)	G ± 0,05 (.002)	H ± 0,05 (.002)	J ± 0,05 (.002)
E	Front	23,01 (.906)	11,50 (.453)	24,99 (.984)	12,49 (.492)	13,84 (.545)	6,93 (.273)	2,23 (.088)	1,11 (.044)	2,10 (.083)
E	Rear	21,28 (.838)	10,64 (.419)	24,99 (.984)	12,49 (.492)	12,21 (.481)	6,12 (.241)	2,23 (.088)	1,11 (.044)	3,35 (.132)
A	Front	31,34 (1.234)	15,67 (.617)	33,32 (1.312)	16,66 (.656)	13,84 (.545)	6,93 (.273)	2,23 (.088)	1,11 (.044)	2,10 (.083)
A	Rear	29,61 (1.166)	14,80 (.583)	33,32 (1.312)	16,66 (.656)	12,21 (.481)	6,12 (.241)	2,23 (.088)	1,11 (.044)	3,35 (.132)
B	Front	45,08 (1.775)	22,55 (.888)	47,04 (1.852)	23,52 (.926)	13,84 (.545)	6,93 (.273)	2,23 (.088)	1,11 (.044)	2,10 (.083)
B	Rear	43,33 (1.706)	21,66 (.853)	47,04 (1.852)	23,52 (.926)	12,21 (.481)	6,12 (.241)	2,23 (.088)	1,11 (.044)	3,35 (.132)
C	Front	61,54 (2.423)	30,78 (1.212)	63,50 (2.500)	31,75 (1.250)	13,84 (.545)	6,93 (.273)	2,23 (.088)	1,11 (.044)	2,10 (.083)
C	Rear	59,79 (2.354)	29,89 (1.177)	63,50 (2.500)	31,75 (1.250)	12,21 (.481)	6,12 (.241)	2,23 (.088)	1,11 (.044)	3,35 (.132)
D	Front	59,15 (2.329)	29,59 (1.165)	61,11 (2.406)	30,55 (1.203)	16,63 (.655)	8,33 (.328)	2,23 (.088)	1,11 (.044)	2,10 (.083)
D	Rear	57,15 (2.250)	28,57 (1.125)	61,11 (2.406)	30,55 (1.203)	14,90 (.587)	7,46 (.294)	2,23 (.088)	1,11 (.044)	3,35 (.132)



Dimensions shown in: mm (inch)  
Specifications and dimensions subject to change



# MIL 24308 Class M Series

## D\*M – D\*MA connectors and crimp contacts

### Mounting Conditions

Mounting Conditions defined the dimension in which mating is sufficient to reach electrical data collection.

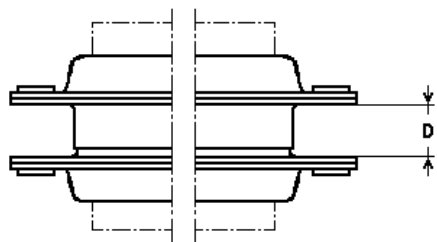

Front Panel Mounting

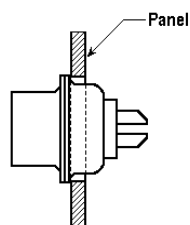

Standard Shell

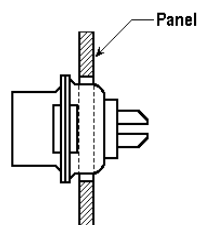

Dual Float Mount Shell

Rear Panel Mounting

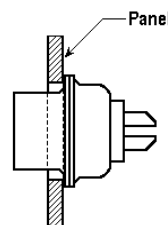

Standard Shell

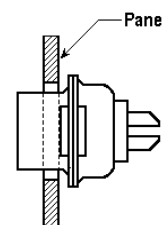

Dual Float Mount Shell

Shell Size	D min	D max
E	6,35 (.250)	7,11 (.280)
A	6,35 (.250)	7,11 (.280)
B	6,12 (.241)	6,88 (.271)
C	6,12 (.241)	6,88 (.271)
D	6,12 (.241)	6,88 (.271)

### Fixing Options

Through Hole (Eyelet)  
Or central swaging

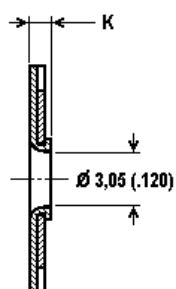

Dimension K - Plug

Shell Size	$\pm 0,33 (.013)$	$\pm 0,25 (.010)$
E	1,21 (.048)	
A	1,21 (.048)	
B		1,52 (.060)
C		1,52 (.060)
D		1,52 (.060)

Dual Float Mount (Y) or Tab version.

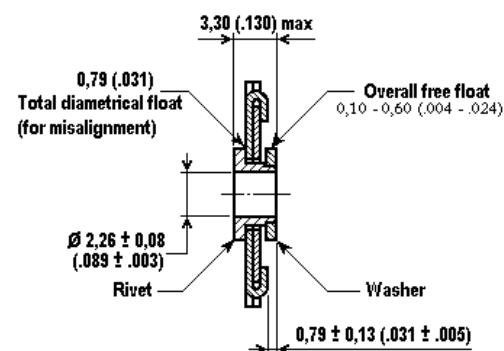

Dimension K – Receptacle

Shell Size	$\pm 0,318 (.013)$
E	1,21 (.048)
A	1,21 (.048)
B	1,21 (.048)
C	1,21 (.048)
D	1,21 (.048)

# MIL 24308 Class M Series

## D\*M – D\*MA connectors and crimp contacts

### D\*M Standard density – Solder bucket dimensions

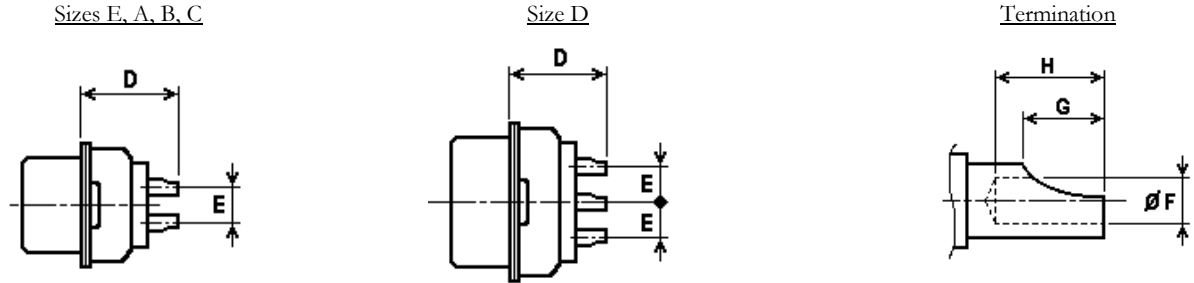

Contacts	Shell Size	D ± 0,60 (.024)	E Typical	F + 0,05 (.002) / 0	G ± 0,55 (.022)	H min	Pitch between contacts
Male	E	9,60 (.378)	2,84 (.112)	1,10 (.043)	1,95 (.077)	2,40 (.094)	2,74 (.108)
	A	9,60 (.378)	2,84 (.112)	1,10 (.043)	1,95 (.077)	2,40 (.094)	2,74 (.108)
	B	9,80 (.386)	2,84 (.112)	1,10 (.043)	1,95 (.077)	2,40 (.094)	2,76 (.109)
	C	9,80 (.386)	2,84 (.112)	1,10 (.043)	1,95 (.077)	2,40 (.094)	2,76 (.109)
	D	9,80 (.386)	2,84 (.112)	1,10 (.043)	1,95 (.077)	2,40 (.094)	2,76 (.109)
Female	E	9,60 (.378)	2,84 (.112)	1,10 (.043)	1,95 (.077)	2,40 (.094)	2,74 (.108)
	A	9,60 (.378)	2,84 (.112)	1,10 (.043)	1,95 (.077)	2,40 (.094)	2,74 (.108)
	B	9,60 (.378)	2,84 (.112)	1,10 (.043)	1,95 (.077)	2,40 (.094)	2,76 (.109)
	C	9,60 (.378)	2,84 (.112)	1,10 (.043)	1,95 (.077)	2,40 (.094)	2,76 (.109)
	D	9,60 (.378)	2,84 (.112)	1,10 (.043)	1,95 (.077)	2,40 (.094)	2,76 (.109)

#### Weights

	Shell Size	Male Contact	Female Contact
Max Weight (grams) per contact		0.19	0.22
Max Weight (grams) of all contacts per size	E	1.71	1.98
	A	2.85	3.30
	B	4.75	5.50
	C	7.03	8.14
	D	9.50	11.00

#### Recommended instruction for wire stripping :

Cut wires to length and strip insulation per above illustration. Check for broken or frayed wires

Accepted Wires Sizes : insulated AWG 20, AWG 22, AWG 24.

Recommended wire trim length

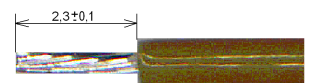

# MIL 24308 Class M Series

## D\*M – D\*MA connectors and crimp contacts

D\*M Standard density – Termination modifier : D , L , S.  
 (90° Bent PCB with monobloc plastic brackets. US Fo otprint)  
 D : Plug versions available.  
 L and S : Plug and Receptacle versions available.

Sizes E, A, B, C

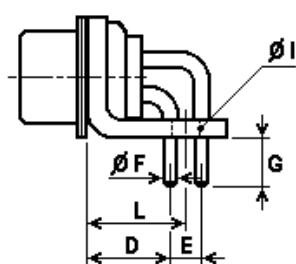

Size D

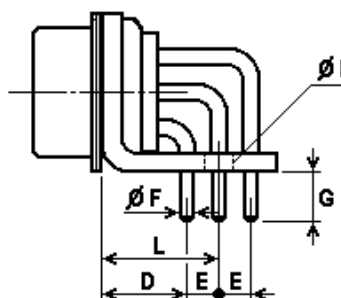

Termination Modifier	F ± 0,05 (.002)	G ± 0,69 (.027)
D	0,76 (.030)	3,21 (.126)
L	0,76 (.030)	4,01 (.158)
S	0,76 (.030)	4,65 (.183)

1 piece plastic bracket  
 Hole Ø I : 3,05 (.120) ± 0,13 (.005)

Contacts	Shell Size	D min	D max	E Typical	L ± 0,25 (.010)	Pitch between contacts
Male	E	6,93 (.273)	7,43 (.293)	2,84 (.112)	8,60 (.339)	2,74 (.108)
	A	6,93 (.273)	7,43 (.293)	2,84 (.112)	8,60 (.339)	2,74 (.108)
	B	6,93 (.273)	7,43 (.293)	2,84 (.112)	8,60 (.339)	2,76 (.109)
	C	6,93 (.273)	7,43 (.293)	2,84 (.112)	8,60 (.339)	2,76 (.109)
	D	6,93 (.273)	7,43 (.293)	2,84 (.112)	1,02 (.394)	2,76 (.109)
Female	E	6,93 (.273)	7,43 (.293)	2,84 (.112)	8,60 (.339)	2,74 (.108)
	A	6,93 (.273)	7,43 (.293)	2,84 (.112)	8,60 (.339)	2,74 (.108)
	B	6,93 (.273)	7,43 (.293)	2,84 (.112)	8,60 (.339)	2,76 (.109)
	C	6,93 (.273)	7,43 (.293)	2,84 (.112)	8,60 (.339)	2,76 (.109)
	D	6,93 (.273)	7,43 (.293)	2,84 (.112)	1,02 (.394)	2,76 (.109)

### Weights

	Shell Size	Male Contact	Female Contact	Plastic Bracket
Max Weight (grams) per contact		0.24 / 0.28 / 0.32	0.29 / 0.34 / 0.37	
Max Weight (grams) of all contacts per size	E	2.36	2.86	1.49
	A	3.92	4.75	1.72
	B	6.52	7.90	2.05
	C	9.64	11.68	2.41
	D	14.00	16.66	3.22



Dimensions shown in: mm (inch)  
 Specifications and dimensions subject to change

# MIL 24308 Class M Series

## D\*M – D\*MA connectors and crimp contacts

### D\*M Standard density – Termination modifier : D , L , S. PCB Hole Pattern

#### Face view, pin insert

Size E  
9 contacts

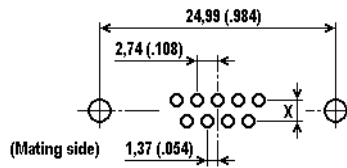

Size A  
15 contacts

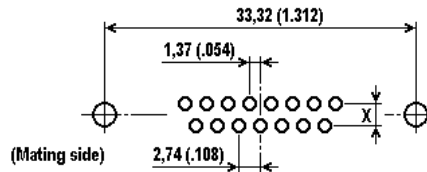

Size B  
25 contacts

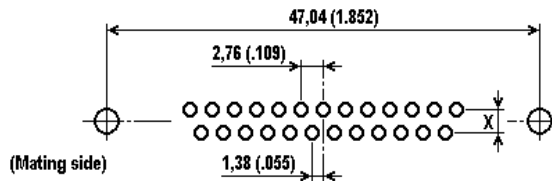

Size C  
37 contacts

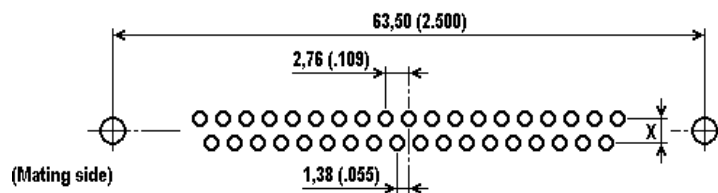

Size D  
50 contacts

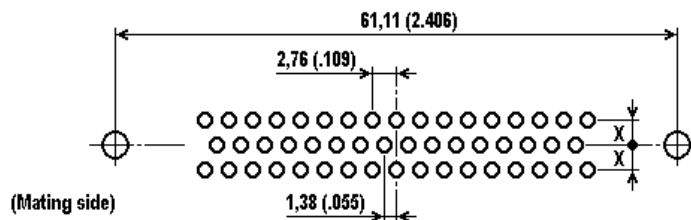

Dimension X

◆ 2,84 (.112) for "90° bent PCB U.S. Footprint"

Recommended PCB hole for signal contacts



Dimensions shown in: mm (inch)  
Specifications and dimensions subject to change

# MIL 24308 Class M Series

## D\*M – D\*MA connectors and crimp contacts

◆  $\varnothing$  1,15 (.045) min for terminations  $\varnothing$  0,76 (.030)

### D\*MA Standard and High density – Specific dimensions

Connectors equipped with contacts size 20/20 or 22/22

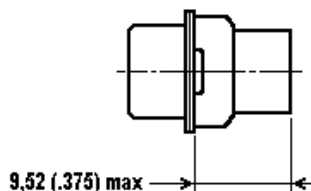

**Male connector**

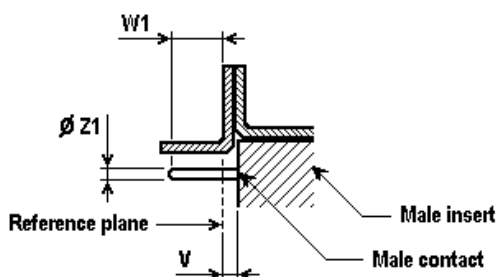

**Female connector**

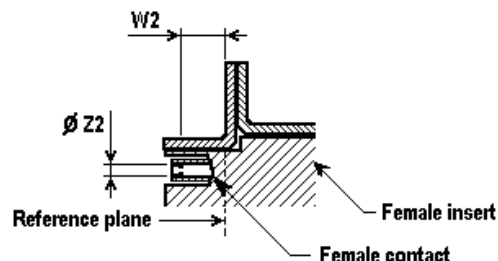

Shell Size	V max	W1 min (Full pin diameter)		W1 max (Full pin diameter)		W2 min (Square ended pin)	
		S.D. (# 20)	H.D. (# 22)	S.D. (# 20)	H.D. (# 22)	S.D. (# 20)	H.D. (# 22)
E	0,40 (.016)	4,36 (.172)	4,43 (.174)	5,48 (.216)	5,45 (.215)	3,77 (.148)	3,63 (.143)
A	0,40 (.016)	4,36 (.172)	4,43 (.174)	5,48 (.216)	5,45 (.215)	3,77 (.148)	3,63 (.143)
B	0,60 (.024)	4,26 (.168)	4,33 (.170)	5,38 (.212)	5,45 (.215)	3,77 (.148)	3,63 (.143)
C	0,60 (.024)	4,26 (.168)	4,33 (.170)	5,38 (.212)	5,45 (.215)	3,77 (.148)	3,63 (.143)
D	0,60 (.024)	4,26 (.168)	4,33 (.170)	5,38 (.212)	5,45 (.215)	3,77 (.148)	3,63 (.143)

$\varnothing$  Z1 : 0,99 (.039) / 1,04 (.041) S.D. (# 20), or 0,75 (.0295) / 0,77 (.0305) H.D. (# 22)

$\varnothing$  Z2 : to accommodate a 1,02 (.040) diameter pin S.D. (# 20), or a 0,76 (.030) diameter pin H.D. (# 22)

### Weights

Max Weight (grams) without contacts and without accessories **	Shell Size	Standard Density	High Density
	E	6.0	6.0
	A	8.3	8.0
	B	13.6	12.0
	C	18.9	17.0
	D	22.3	20.0

\*\* For contacts weight, refer to next page

For dual float mount (Y), weight if applicable, added 0,60 grams



Dimensions shown in: mm (inch)  
Specifications and dimensions subject to change

## X-ON Electronics

Largest Supplier of Electrical and Electronic Components

*Click to view similar products for [D-Sub MIL Spec Connectors](#) category:*

*Click to view products by [C&K](#) manufacturer:*

Other Similar products are found below :

[M24308/4-13Z](#) [M8351307-B](#) [D38999/20FJ43HN](#) [D38999/24WG11PB-LC](#) [D38999/24WG41HN](#) [MDM-15PH041P](#) [MDM-21PH041P](#) [MDM-21SH003B-K139](#) [850-056-0812](#) [1218697-4](#) [DBMM25S](#) [MS27467T21F41S](#) [17D25HV](#) [1996840-1](#) [243082-15](#) [1663962-1](#) [1757682-1](#) [17D-E51218-1](#) [17SDA15S](#) [1883533-1](#) [1883886-1](#) [1883889-1](#) [192900-0377](#) [308-CP6P0441-024H](#) [M24308/2-3Z](#) [M24308/4-3Z](#) [M24308/4-4F](#) [M24308/4-4Z](#) [M24308/8-347](#) [M83513/03-E09C](#) [M83723/75W2212N L/C](#) [D38999/24FJ29PN-LC](#) [D38999/24WG11SB-LC](#) [MDM-21PH046P](#) [5-1218949-1](#) [550-031NF1R6K](#) [550E001NF1R3J0L](#) [550T001NF1R6K0L](#) [557T283NF5B08](#) [C115368-1612B](#) [C115370-1717B](#) [DC121073157](#) [443869-3](#) [443869-4](#) [443869-5](#) [550S004NF1R1B0F03](#) [550-031NF1R2E](#) [550E003M2R9J0F04](#) [550E003M3R9J0F05](#) [550E024M104R9J0](#)