

# Military/Aerospace/Hi-REL MIL-S-83731 Toggle Switches

## Features/Benefits

- Qualified to MIL-S-83731 Cage Code 63HW9
- 50  $\mu$  inch selective gold contact plating
- Epoxy sealed terminals for process compatibility
- Rated for logic level to 5 amp resistive loads and 2 amp inductive loads
- Flame retardant housing material
- RoHS compliant and compatible

Test Requirement	MIL-S-83731/9, 10, 13, 14, 15, 16
1. Strength of Terminal	1 lb. – solder lug
2. Strength of Actuating Lever Pivot and Stop	10 lbs. & 8 lbs. throughout range
3. Strength of Mounting Means	15 lbs. in. torque on bushing
4. Dielectric (Sea Level) Indication	1000 VAC Group B, 750 VAC after electrical endurance. 500 $\mu$ A max. leakage
5. Contact Voltage Drop	2.5 millivolt initial, 5.0 millivolt after mechanical endurance @ 2-6 VDC 0.1 amp
6. Temperature Rise	50° C rise max. @ rated resistive load after endurance test
7. Short Circuit	10 operations carry 100 amps resistive load @ lowest DC volts
8. Mechanical Life	20K operations at specified high and low temperatures
9. Electrical Endurance	10K operations at specified high and low temperatures
10. Overload	50 operations @ 150% of rated resistive load
11. Electrical Endurance at Sea Level	10K operations resistive load @ room temperature 10K operations inductive load @ room temperature 10K operations lamp load @ room temperature Performed on different test samples
12. Vibration	Method 204 of MIL-STD-202, test condition A .06 D. A. or 10 G's 10-500 Hz, 10 usec. max. chatter
13. Shock	Fuse-method 213 or MIL-STD-202, 10 usec. max. chatter
14. Salt Spray Test Upon Completion	48 hours – method 101 of MIL-STD-202, test condition B 10 operations resistive load (toggle sealed switches only)
15. Moisture Resistance Test Upon Completion	Method 106 of MIL-STD-202 100 VDC potential between current carrying parts and panel
16. Sand & Dust	Method 110 of MIL-STD-202, test condition B 6 hours @ 23°C 2.5K operations mechanical life (toggle sealed switches only)
17. Explosion	MIL-STD-202 method 109, maximum rated DC inductive load (toggle sealed switches only)
18. Sealing	Toggle seal – 5 operations under 0.5 inches of H <sub>2</sub> O above top of bushing
19. A.) Toggle Seal B.) Bushing Seal	(Toggle sealed switches only) (Panel sealed switches only)
20. Temperature Operation	Mechanical life, –25°C to +71°C
21. Life Low Cur. Level	No requirement
22. Fungus	No requirement
23. Intermediate Current	20K operations, 35/40 milliamps @ 5 VDC resistive load @ +71°C
24. Thermal Shock	Method 107 of MIL-STD-202 test condition A; 5 cycles @ –55°C/+85°C

## RATINGS

### CURRENT RATINGS – HIGH LEVEL

Current Capacity in Amperes – Per Pole		
28V dc	115V ac, 400 Hz	125V ac, 60 Hz
Lamp Load		
1	1	1
Resistive Load		
5	5	5
Inductive Load		
2	2	2

### CURRENT RATINGS – LOGIC LEVEL

0.5 Volt – Amp (VA) Max. @ 28 V Max. (AC or DC)
---

## MATERIALS

CASE: Diallyl phthalate (DAP) (UL 94 V-0).  
 BUSHING: Brass, nickel plated.  
 HOUSING: Stainless steel.  
 ACTUATOR: Brass, chrome plated.  
 SWITCH SUPPORT: Brass, tin plated.  
 TERMINALS: Gold over nickel over copper alloy.  
 TERMINAL SEAL: Epoxy.  
 CONTACTS: Gold over nickel over silver over brass.  
 PANEL SEAL: Silicone rubber.  
 MOUNTING HARDWARE: Two hexagon nut, brass with nickel plating; one lockwasher, steel with nickel plating; one locking ring, brass with nickel plating.

**HOW TO ORDER:** Complete part numbers for MIL-S-83731 TOGGLE SWITCHES are shown on pages F–18 through F–21.



F

Toggle



# Military/Aerospace/Hi-REL MIL-S-83731 Toggle Switches



NO. POLES	MODEL NO.	SWITCH FUNCTION			CONNECTED TERMINALS			SCHEMATIC
		POS. 1	POS. 2	POS. 3	POS. 1	POS. 2	POS. 3	
SP	M83731/9-212	ON	OFF	ON	2-3	OPEN	2-1	
	M83731/9-232	ON	NONE	ON		N/A		
	M83731/9-262	ON	NONE	MOM.				
	M83731/9-272	MOM.	OFF	MOM.		OPEN		
	M83731/9-312	ON	OFF	MOM.				
M83731/9-342	NONE	ON	MOM.	N/A	2-3	2-1		

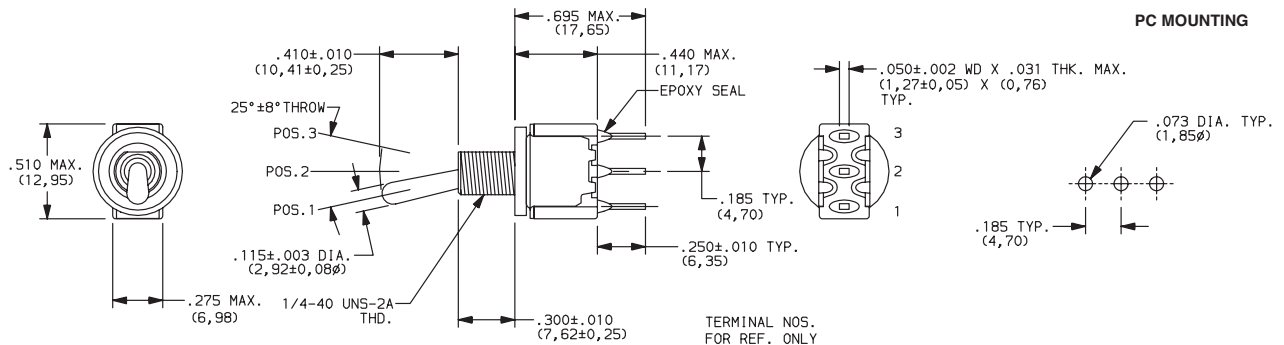

SPDT



NO. POLES	MODEL NO.	SWITCH FUNCTION			CONNECTED TERMINALS			SCHEMATIC		
		POS. 1	POS. 2	POS. 3	POS. 1	POS. 2	POS. 3			
DP	M83731/10-212	ON	OFF	ON	2-3,5-6	OPEN	2-1,5-4			
	M83731/10-232	ON	NONE	ON		N/A				
	M83731/10-262	ON	NONE	MOM.						
	M83731/10-272	MOM.	OFF	MOM.		OPEN				
	M83731/10-312	ON	OFF	MOM.						
	M83731/10-322	ON	ON	ON		2-3,5-6			2-3,5-4	2-1,5-4
	M83731/10-332	ON	ON	MOM.						
	M83731/10-342	NONE	ON	MOM.		N/A			2-3,5-6	2-1,5-4
M83731/10-352	MOM.	ON	MOM.	2-3,5-6	2-3,5-4	2-1,5-4				

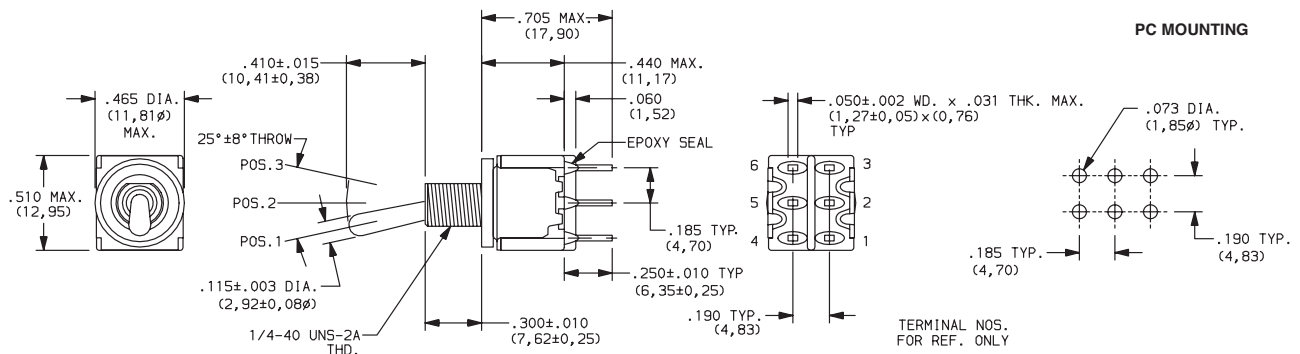

DPDT



# Military/Aerospace/HI-REL MIL-S-83731 Toggle Switches

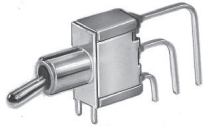

NO. POLES	MODEL NO.	SWITCH FUNCTION			CONNECTED TERMINALS			SCHEMATIC
		POS. 1	POS. 2	POS. 3	POS. 1	POS. 2	POS. 3	
SP	M83731/13-211	ON	OFF	ON	2-3	OPEN	2-1	 SPDT
	M83731/13-231	ON	NONE	ON		N/A		
	M83731/13-261	ON	NONE	MOM.				
	M83731/13-271	MOM.	OFF	MOM.				
	M83731/13-311	ON	OFF	MOM.				
	M83731/13-341	NONE	ON	MOM.		N/A		

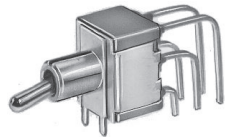
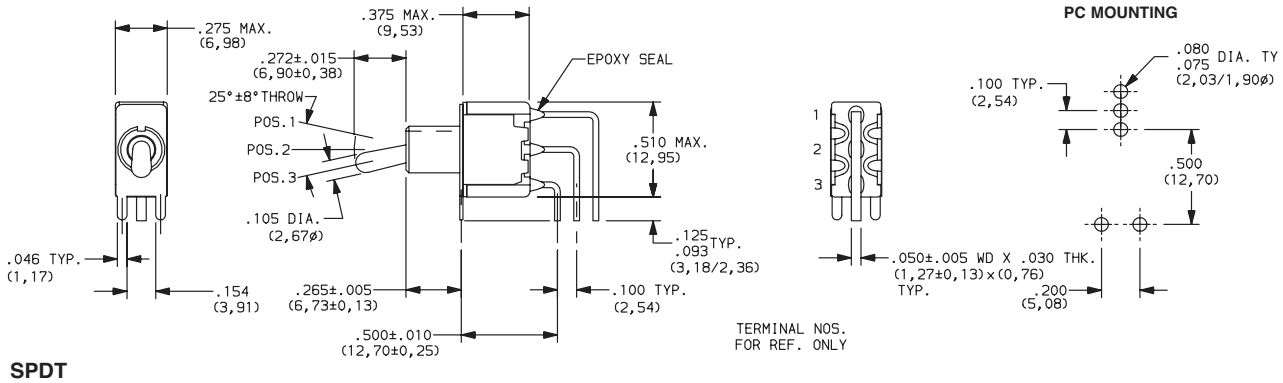

NO. POLES	MODEL NO.	SWITCH FUNCTION			CONNECTED TERMINALS			SCHEMATIC		
		POS. 1	POS. 2	POS. 3	POS. 1	POS. 2	POS. 3			
DP	M83731/14-211	ON	OFF	ON	2-3,5-6	OPEN	2-1,5-4	 DPDT		
	M83731/14-231	ON	NONE	ON		N/A				
	M83731/14-261	ON	NONE	MOM.						
	M83731/14-271	MOM.	OFF	MOM.						
	M83731/14-311	ON	OFF	MOM.						
	M83731/14-321	ON	ON	ON						
	M83731/14-331	ON	ON	MOM.		2-3,5-6			2-3,5-4	2-1,5-4
	M83731/14-341	NONE	ON	MOM.		N/A			2-3,5-6	2-1,5-4
M83731/14-351	MOM.	ON	MOM.	2-3,5-6	2-3,5-4	2-1,5-4				

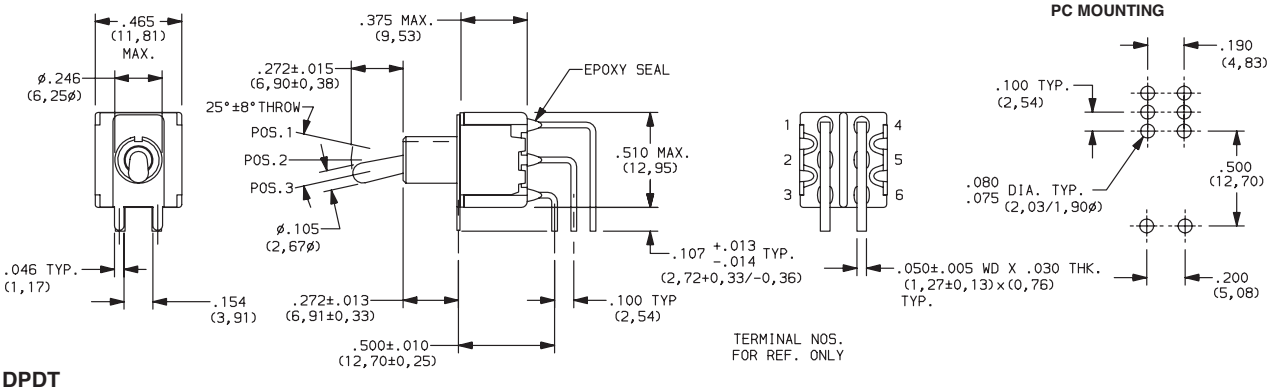

Toggle F

# Military/Aerospace/Hi-REL MIL-S-83731 Toggle Switches



NO. POLES	MODEL NO.	SWITCH FUNCTION			CONNECTED TERMINALS			SCHEMATIC
		POS. 1	POS. 2	POS. 3	POS. 1	POS. 2	POS. 3	
SP	M83731/15-211	ON	OFF	ON	2-3	OPEN	2-1	 SPDT
	M83731/15-231	ON	NONE	ON				
	M83731/15-261	ON	NONE	MOM.				
	M83731/15-271	MOM.	OFF	MOM.				
	M83731/15-311	ON	OFF	MOM.				
	M83731/15-341	NONE	ON	MOM.		N/A		

### PC MOUNTING

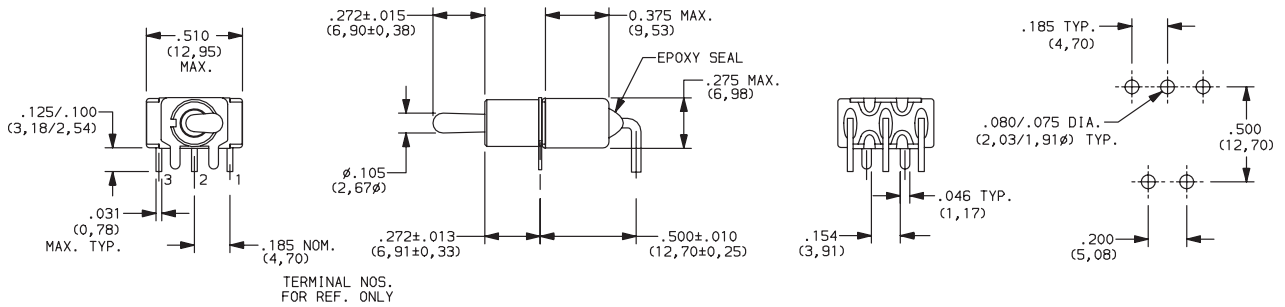

### SPDT



NO. POLES	MODEL NO.	SWITCH FUNCTION			CONNECTED TERMINALS			SCHEMATIC		
		POS. 1	POS. 2	POS. 3	POS. 1	POS. 2	POS. 3			
DP	M83731/16-211	ON	OFF	ON	2-3,5-6	OPEN	2-1,5-4	 DPDT		
	M83731/16-231	ON	NONE	ON						
	M83731/16-261	ON	NONE	MOM.						
	M83731/16-271	MOM.	OFF	MOM.						
	M83731/16-311	ON	OFF	MOM.						
	M83731/16-321	ON	ON	ON						
	M83731/16-331	ON	ON	MOM.		2-3,5-6			2-3,5-4	2-1,5-4
	M83731/16-341	NONE	ON	MOM.		N/A			2-3,5-6	2-1,5-4
M83731/16-351	MOM.	ON	MOM.	2-3,5-6	2-3,5-4	2-1,5-4				

### PC MOUNTING

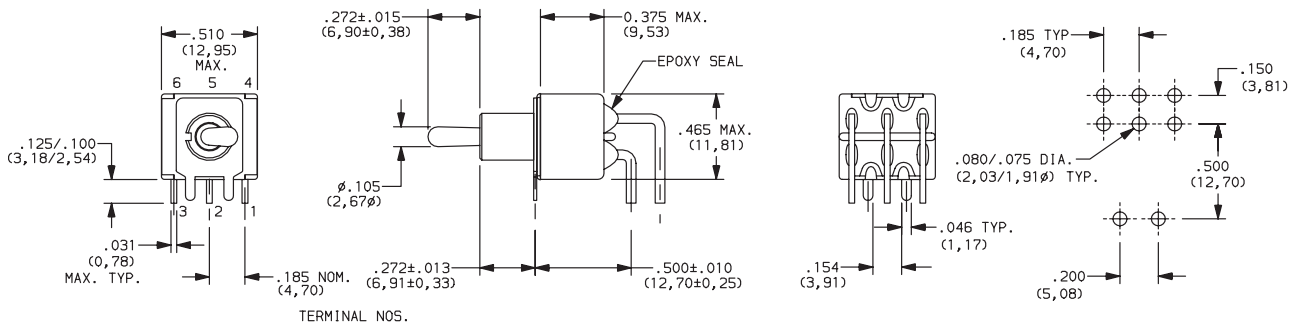

### DPDT



F

Toggle

## X-ON Electronics

Largest Supplier of Electrical and Electronic Components

*Click to view similar products for [Toggle Switches](#) category:*

*Click to view products by [C&K](#) manufacturer:*

Other Similar products are found below :

[8928K478](#) [8A1-C-222](#) [020017-13](#) [60012L](#) [6006L](#) [CS115W](#) [CS120W](#) [6663](#) [7101SPDV30BE](#) [7103SDV30BE](#) [7105D](#) [7108P3YAV2BE](#)  
[71YY50282](#) [7300K36](#) [7301K38](#) [7306K36](#) [7310K36](#) [7506K4](#) [7592K6](#) [7660K12](#) [7691K14](#) [7700K1](#) [8391K108](#) [8396K108](#) [8811K17](#)  
[8812K14](#) [8824K14](#) [8828K13](#) [8835K3](#) [8858K44](#) [PS83-121G](#) [1-1825192-0](#) [A201SCWZB04](#) [A207SYCB04](#) [A208J61ZQ0004](#) [A221T1TCQ](#)  
[A323S1CWZQ](#) [A423S1CWZG-M8](#) [1201W](#) [12156AX408](#) [12147AGKX679](#) [12246X778](#) [12TW49-3D](#) [130312](#) [13037L](#) [13001X](#)  
[AE101MD1W4B04](#) [AE208SD1W4B04](#) [MS24659-22D](#) [MS27407-5](#)