

# MM Series Subminiature Precision Snap-acting Switches

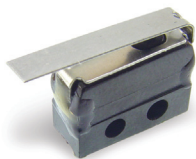

## Features/Benefits

- Low level and power switching
- Long electrical and mechanical life
- Increased overtravel
- Reliable snap-acting mechanism

## Typical Applications

- Limited space constraints
- Communication devices

## Specifications

CONTACT RATING: From low level\* to 7 AMPS @ 250 V AC.  
 ELECTRICAL LIFE: 100,000 cycles at full rated load.  
 INSULATION RESISTANCE: 1,000 ohm min.  
 DIELECTRIC STRENGTH: 1,000 V RMS min. @ sea level.  
 OPERATING TEMPERATURE: -67 F to 275 F (-55 C to 135 C).  
 OPERATING FORCE: 5 oz. (142 grams) max. at actuator button.  
 MOUNTING: 2-56 screws, torque 2 in/lbs max.

\*Low Level=conditions where no arcing occurs during switching, i.e., 0.4 VA max. @ 20 V AC or DC max.

**NOTE:** Specifications and materials listed above are for switches with standard options. For information on specific and custom switches, consult Customer Service center.

## Materials

SWITCH HOUSING: Heat resistant phenolic (UL 94V-0).  
 ACTUATOR BUTTON: Heat resistant phenolic (UL 94V-0).  
 SPRING: Beryllium copper CDA alloy C17200.  
 PIVOT: Brass CDA alloy 260.  
 MOVABLE CONTACTS: Fine silver for ratings greater than 1 AMP @ 125 V AC. 24K gold for 1 AMP @ 125 V AC or less.  
 STATIONARY CONTACTS: Fine silver inlay on copper CDA alloy C10200 for ratings greater than 1 AMP @ 125 V AC. 24K gold on copper CDA alloy C10200 for 1 AMP @ 125 V AC or less.  
 TERMINALS: Copper CDA alloy C18700.



Snap-acting

## Build-A-Switch

To order, simply select desired option from each category and place in the appropriate box. Available options are shown and described on pages J-44 through J-49. For additional options not shown in catalog, consult Customer Service Center.

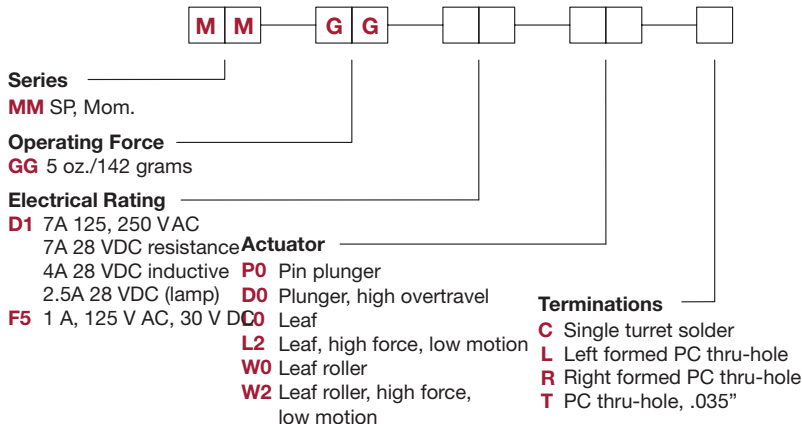

# MM Series Subminiature Precision Snap-acting Switches

## SWITCH WITH STANDARD OPTIONS

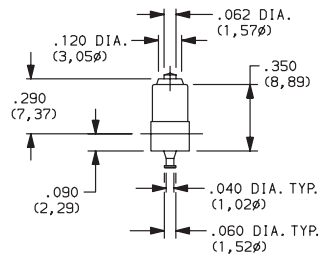
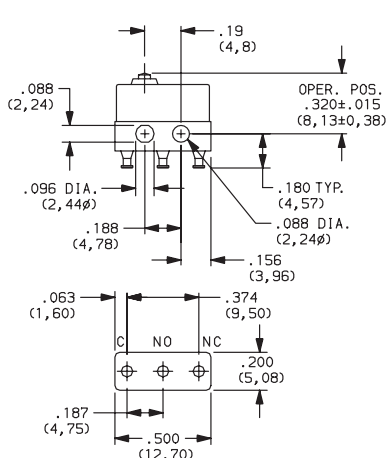

PART NUMBER	BASIC OPERATING FORCE (OZ./GRAMS)	ELECTRICAL RATING
<b>MMGGD1P0C</b>	5 142	7 AMPS @ 250 V AC.

### SERIES ■■■■■■

**MM** SPDT MOMENTARY

### OPERATING FORCE ■■■■■■

OPTION CODE	BASIC SWITCH OPERATING FORCE
<b>GG</b>	5 oz. (142 grams) maximum for basic switch with pin plunger actuator (*'PO' actuator option).

NOTE : Operating force varies with actuator option, see ACTUATOR option section.

### ELECTRICAL RATING ■■■■■■

OPTION CODE	RoHS COMPLIANT*	RoHS COMPATIBLE*	CONTACT MATERIAL		ELECTRICAL RATING
			MOVABLE CONTACT	STATIONARY CONTACT	
<b>D1</b>	Yes	Yes	Fine silver.	Fine silver inlay on copper alloy.	7A 125, 250 VAC; 7A 28 VDC resistance 4A 28 VDC inductive; 2.5A 28 VDC (lamp)
<b>F5</b>	Yes	Yes	24K Gold.	24K Gold on copper alloy.	From low level* to 1 AMP @ 125 V AC, 30 V DC.

Note: See Technical Data section of this catalog for RoHS compliant and compatible definition and specifications.

All models with all options.

Consult Customer Service Center for availability and delivery of nonstandard ratings.

\* Low Level=conditions where no arcing occurs during switching, i.e., 0.4 VA max. @ 20 V AC or DC max.

### ACTUATOR ■■■■■■

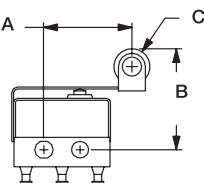
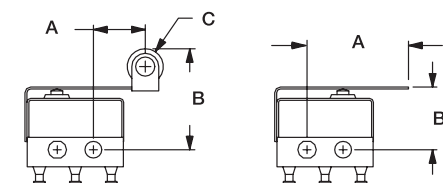
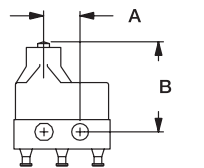
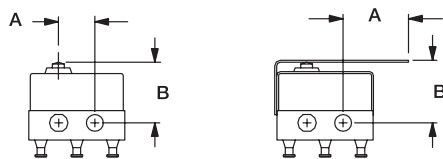

OPTION CODE	FIG.	DIM. A	DIM. B	DIM. C
<b>P0</b>	1	.19 (4,8)	.320 ± .015 (8,13 ± 0,38)	—
<b>D0</b>	3	.19 (4,8)	.475 ± .031 (12,07 ± 0,79)	—
<b>L0</b>	2	.34 (8,6)	.330 ± .015 (8,38 ± 0,38)	—
<b>L2</b>	5	.53 (13,5)	.330 ± .015 (8,38 ± 0,38)	—
<b>W0</b>	4	.27 (6,9)	.532 ± .025 (13,51 ± 0,64)	.188 dia. (4,78φ)
<b>W2</b>	6	.46 (11,7)	.532 ± .025 (13,51 ± 0,64)	.188 dia. (4,78φ)

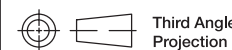

Dimensions are shown: Inches (mm)  
Specifications and dimensions subject to change



Snap-acting

# MM Series Subminiature Precision Snap-acting Switches

## ACTUATOR ■ ■ ■ ■ ■ ■ ■ ■

### SWITCH CHARACTERISTICS

OPTION CODE	MAXIMUM OPERATING FORCE (OZ./GRAMS)	MINIMUM RELEASE FORCE (OZ./GRAMS)	MAXIMUM DIFFERENTIAL TRAVEL	MAXIMUM PRETRAVEL	MINIMUM OVERTRAVEL
D0	5 142	.7 20	.004 (0,10)	.030 (0,76)	.040 (1,02)
L0	4 115	.7 20	.025 (0,64)	.090 (2,29)	.045 (1,14)
L2	6 170	.7 20	.012 (0,30)	.075 (1,90)	.015 (0,38)
P0	5 142	1 28	.002 (0,05)	.020 (0,51)	.004 (0,10)
W0	4 115	.7 20	.025 (0,64)	.090 (2,29)	.045 (1,14)
W2	6 170	.7 20	.012 (0,30)	.075 (1,90)	.015 (0,38)

NOTE : For basic switch operating forces, see page J-44

## TERMINATIONS ■ ■ ■ ■ ■ ■ ■ ■

### C SINGLE TURRET SOLDER

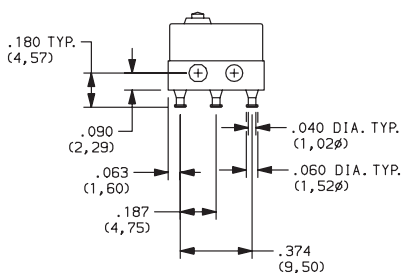

### L LEFT FORMED PC THRU-HOLE

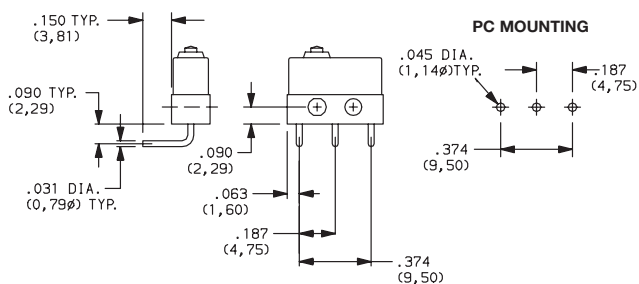

### T PC THRU-HOLE, .035"

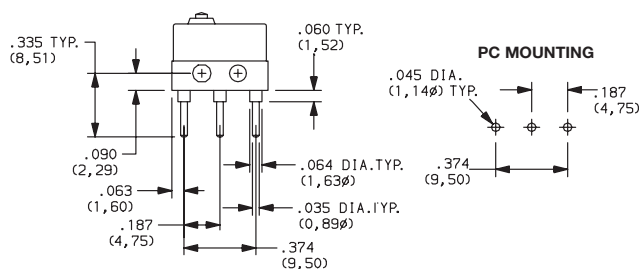

### R RIGHT FORMED PC THRU-HOLE

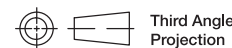
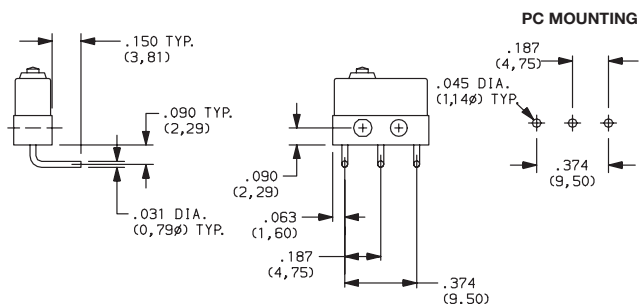

Third Angle  
Projection

Dimensions are shown: Inch (mm)  
Specifications and dimensions subject to change

## X-ON Electronics

Largest Supplier of Electrical and Electronic Components

*Click to view similar products for [Basic / Snap Action Switches](#) category:*

*Click to view products by [C&K](#) manufacturer:*

Other Similar products are found below :

[83228001](#) [01.098.1358.1](#) [602EN1-6B](#) [602EN532](#) [602EN535-RB](#) [602HE5-RB1](#) [604HE162](#) [604HE223-6B](#) [624HE17-RB](#) [6HM89](#) [6PA78-JM](#)  
[6SE1](#) [6SX1-H58](#) [70500840](#) [MBD5B1](#) [MBH2731](#) [73-316-0012](#) [79211759](#) [79211923](#) [79218589](#) [7AS12](#) [ML-1155](#) [ML-1376](#) [831010C3.0](#)  
[831060C3.TL](#) [831090C2.EL](#) [83131904](#) [84212012](#) [8AS239](#) [8HM73-3](#) [903VB1-PG](#) [914CE1-6G](#) [PL-100](#) [11SM1077-H4](#) [11SM1077-H58](#)  
[11SM1-TN107](#) [11SM405](#) [11SM703-T](#) [11SM8423-H2](#) [11SX37-T](#) [11SX48-H58](#) [11SX55-H58](#) [11SM2442-T](#) [11SM76-T](#) [11SM77-H58](#)  
[11SM77-T](#) [11SM863-T](#) [11SM866](#) [11SX47-H58](#) [A7CN-1M-1-LEFT](#)