

NanoT Series

The Most Compact Nano Size Tact Switch

Features

- Ultra Compact Size
- SMT or PIP versions
- IP67
- Integrated Actuator
- High life cycles

Typical Applications

- Hearing Aids
- Headsets
- Sports watch
- IoT portable device



B

Tactile Switches

| Part Number | Style | Force (gf) | Life (Cycles) |
|--------------|-------------------------------------|-------------|---------------|
| NanoT 100 AS | Top Actuated with SMT termination | 100 +40/-30 | 200,000 |
| NanoT 160 AS | Top Actuated with SMT termination | 160 +/- 50 | 300,000 |
| NanoT 240 AS | Top Actuated with SMT termination | 240 +/- 60 | 200,000 |
| NanoT 160 BP | Side actuated with PIP* termination | 160 +/- 50 | 300,000 |
| NanoT 240 BP | Side actuated with PIP* termination | 240 +/- 60 | 200,000 |

*PIP: Pin in Paste also called Pin Through Paste

Specifications

TRAVEL: 0.1 mm +/- 0.05 mm
 OPERATING TEMPERATURE: -40 ~ +85°C
 OPERATING TEMPERATURE: -40 ~ +85°C
 RATING: 15V D.C. / 20mA
 INSULATION RESISTANCE: 100 MΩ Min.
 WITHSTAND VOLTAGE: 250V A.C. (50~60Hz 2mA) for 1 min.
 BOUNCE: ON/OFF 10 ms Max.
 CONTACT RESISTANCE: 500mΩ Max.

Packaging

In reels of 7,500 pieces for the Side actuated
 In reels of 8,000 pieces for the Top actuated
 Dimensions of reels according to EIA RS481 or IEC 2863. External diameter 330 mm ± 2 mm.

How To Order

Our easy build-a-switch concept allows you to mix and match options to create the switch you need. To order, select desired option from each category and place it in the appropriate box.

For any part number different from those listed above, please consult your local representative.

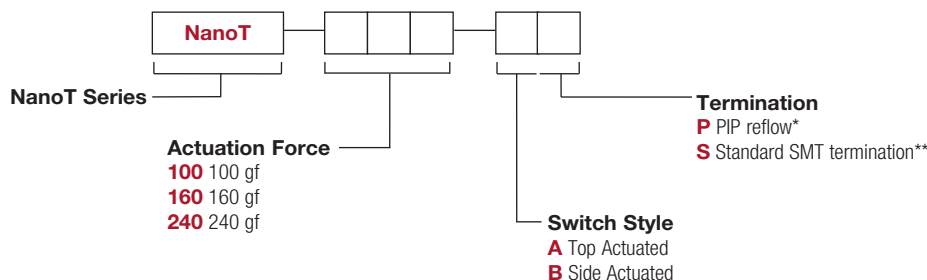

* P termination for side version only
 ** S termination for top version only

NanoT Series

The Most Compact Nano Size Tact Switch

TOP ACTUATED

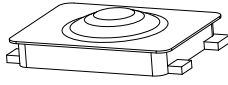
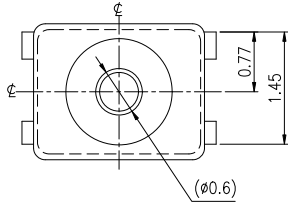

SCHEMATIC

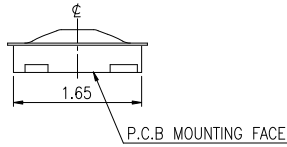
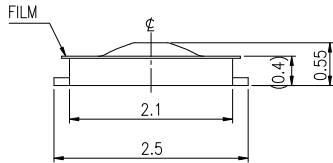
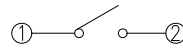

P.C.B LAYOUT

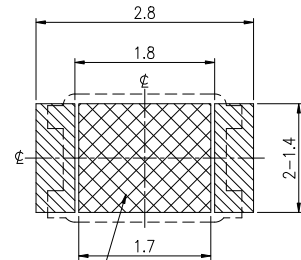

Any land pattern or vias should be prevented at area.

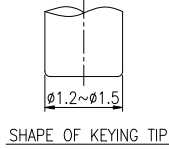
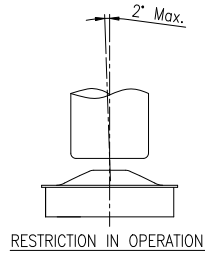
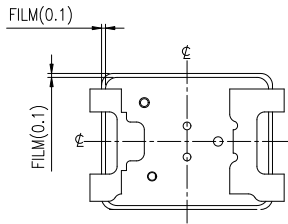

SIDE ACTUATED PIP

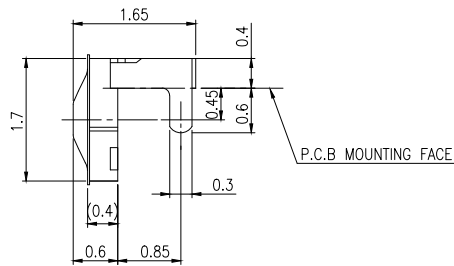
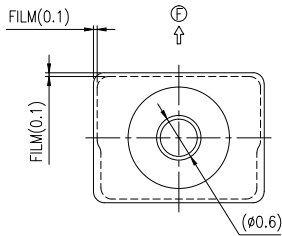
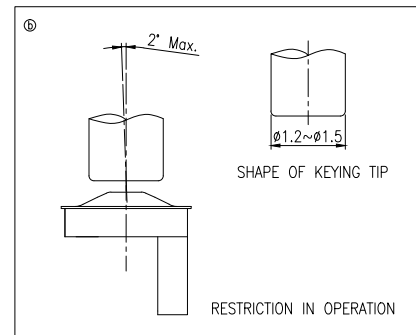
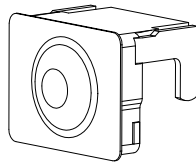
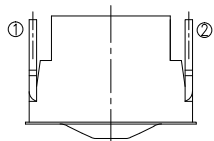

P.C.B MOUNTING FACE

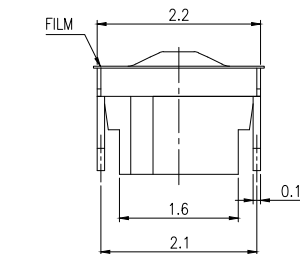
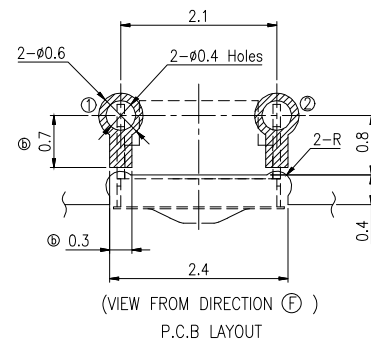
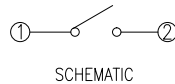

X-ON Electronics

Largest Supplier of Electrical and Electronic Components

Click to view similar products for [Tactile Switches](#) category:

Click to view products by [C&K](#) manufacturer:

Other Similar products are found below :

[6407-250V-25273P](#) [ADTSA62NV](#) [B3F-3123](#) [1977177-8](#) [1977266-1](#) [ADTSA63NV](#) [ADTSM21NSVTR](#) [ADTSM25RVTR](#) [ADTSM32NVTR](#)
[ADTSMW64RV](#) [1977120-6](#) [FSMRA4JHA04](#) [GS4.70F300QP](#) [KSC241J SP DELTA LFS](#) [3FTL600RAS](#) [3FTL640RAS](#) [6407-250V-25343P](#)
[ADTSM31NVTR](#) [2-1977120-7](#) [TSJW-5.2-260-TR](#) [Y651050400P](#) [KMT011MNGJLHS](#) [70-201.0](#) [ADTSG648NV](#) [ADTSM62KSVTR](#)
[ADTSM648NV](#) [95C06E3RAT](#) [3ATH9Q](#) [FSMRA8JHA04](#) [HARS0073](#) [Y33R411N9FPLFT](#) [Y33R51139FPLFT](#) [Y31C01402FPLFS](#)
[PTS645SK50SMTR92](#) [ADTSM32NVB](#) [KMS233GPWTLFG](#) [Y78B64124FP](#) [Y31CJ244KFP LFS](#) [Y33A812C5FP LFT](#) [Y56B2D120FP LFS](#)
[Y31C5144KFP LFS](#) [PTS645 DVM83-BN125-2 LFS](#) [B3W 1000G](#) [KSC621G OL LFS](#) [B3F 1002C](#) [B3F 0047H](#) [B3W 1002C](#) [B3F 5001G](#)
[B3W 1100C](#) [1-1571563-4](#)