

# OS Series Miniature Slide Switches

## Features/Benefits

- Variety of actuators & terminations
- PC and panel mounting
- Shorting or non-shorting contacts
- RoHS compliant
- Halogen free material

## Typical Applications

- Test & measurement equipment
- Computer peripherals & network products
- Consumer products

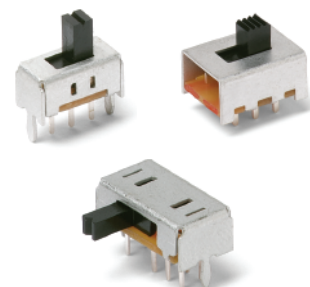

## Specifications

CONTACT RATING: See individual parts.  
 MECHANICAL & ELECTRICAL LIFE: 10,000 cycles.  
 CONTACT RESISTANCE: 20 mΩ or less.  
 INSULATION RESISTANCE: 100 MΩ min. at 500 VDC.  
 DIELECTRIC STRENGTH: 500 VAC for 1 minute.  
 OPERATING TEMPERATURE: -30°C to +70°C.  
 PACKAGING: Bulk

\* For RoHS compatible switches contact customer service.

## Materials

BASE: Phenolic resin.  
 ACTUATOR: Standard: POM, Black.  
 High Temperature Option: PA46, Black.  
 HOUSING PLATE: Non-compatible; SPCC Sn plated.  
 Compatible; SPCC Ni plated.  
 MOVABLE CONTACT: Copper alloy, silver plated.  
 STATIONARY CONTACTS: Brass, silver plated.  
 TERMINALS: Brass, silver plated.  
 TERMINAL SEALED.

**NOTE:** Specifications and materials listed above are for switches with standard options. For information on specific and custom switches, consult Customer Service Center.

## How To Order

Complete part numbers for OS Series Slide Switches are shown on pages I-37 through I-43.

PART NUMBER			SWITCH FUNCTION	
	RoHS Compliant	RoHS Compatible	POS.1	POS.2
OS102011MS2QN1 (non-shorting)	YES	NO	ON	ON
OS102011MS2QN1C* (non-shorting)	YES	YES	ON	ON
OS102011MS2QS1 (shorting)	YES	NO	ON	ON
OS102011MS2QS1C* (shorting)	YES	YES	ON	ON
CONN. TERMINALS			1-2	2-3
SCHMATIC				
SPDT				

CONTACT RATING: 0.1A @ 12 VDC

\* "C" option at the end of part number designates high temperature actuators

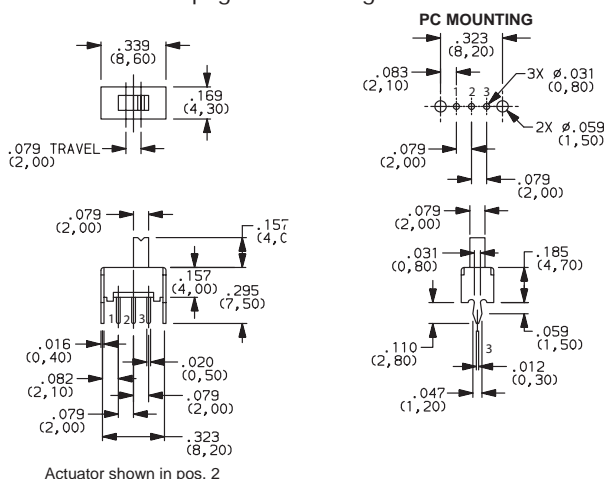

Actuator shown in pos. 2

OS102011MS2QN1  
SPDT

PART NUMBER			SWITCH FUNCTION		
	ROHS Compliant	ROHS Compatible	POS.1	POS.2	POS.3
OS103011MS8QP1 (Non-specified)	YES	NO	ON	ON	ON
OS103011MS8QP1C* (Non-specified)	YES	YES	ON	ON	ON
CONN. TERMINALS			1-2	2-3	2-4
SCHMATIC					
SP3T					

CONTACT RATING: 0.1A @ 12 VDC

\* "C" option at the end of part number designates high temperature actuators

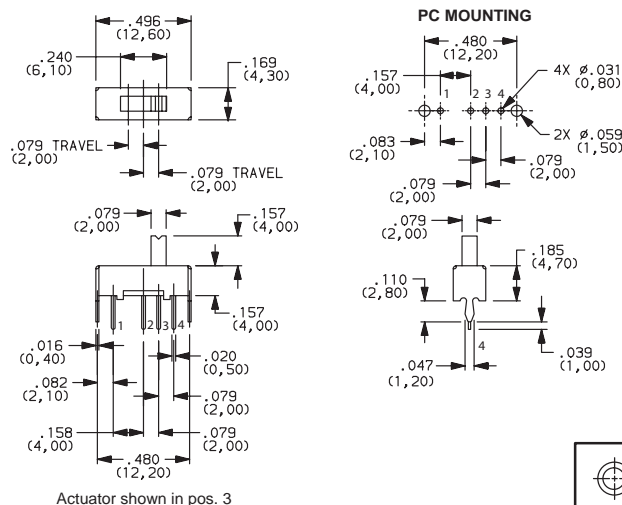

Actuator shown in pos. 3

OS103011MS8QP1  
SP3T



Dimensions are shown: Inches (mm)

Specifications and dimensions subject to change



8 aug 17

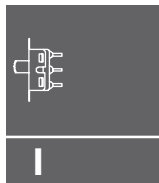

Slide

# OS Series Miniature Slide Switches

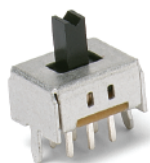

OS202011MS2QS1  
DPDT

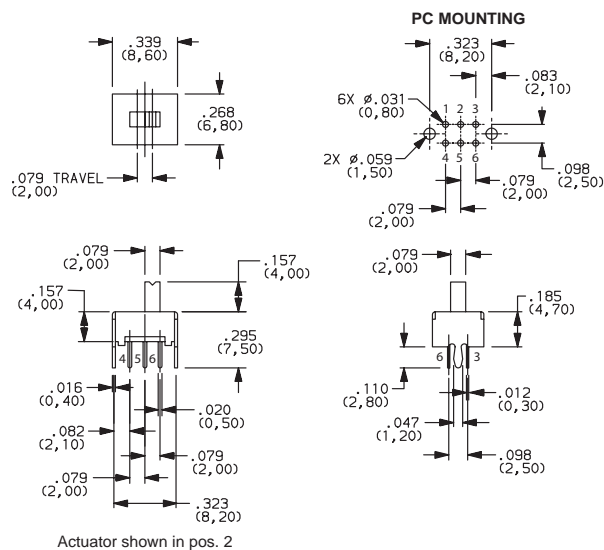

PART NUMBER	RoHS Compliant	RoHS Compatible	SWITCH FUNCTION	
			POS.1	POS.2
OS202011MS2QS1 (Shorting)	YES	NO	ON	ON
OS202011MS2QN1 (Non-shorting)	YES	NO	ON	ON
CONN. TERMINALS			1-2, 4-5	2-3, 5-6
SCHEMATIC				
DPDT				

CONTACT RATING: 0.1A @ 12 VDC

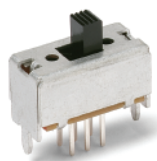

OS203011MS1QP1  
DP3T

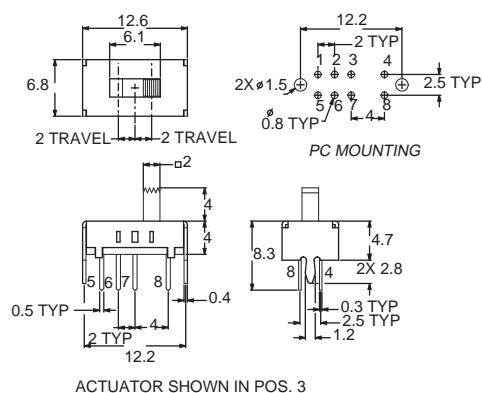

PART NUMBER	ROHS Compliant	ROHS Compatible	SWITCH FUNCTION		
			POS.1	POS.2	POS.3
OS203011MS1QP1 (Non-specified)	YES	NO	ON	ON	ON
CONN. TERMINALS			1-3, 5-7	2-3, 6-7	3-4, 7-8
SCHEMATIC					
DP3T					

CONTACT RATING: 0.3A @ 30 VDC

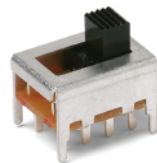

OS202013MT5QN1  
DPDT

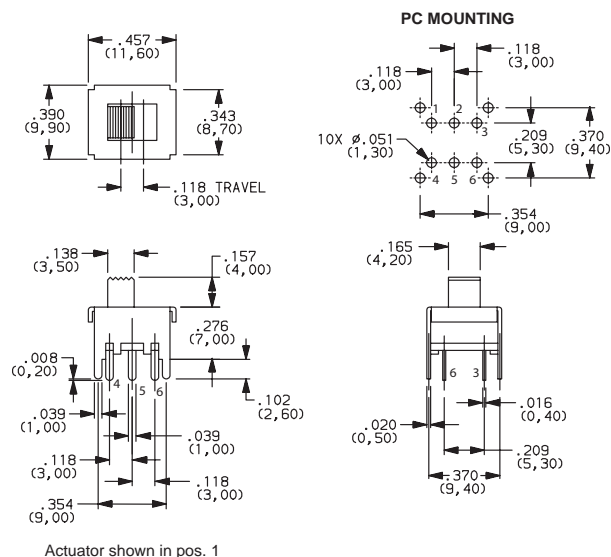

PART NUMBER	RoHS Compliant	RoHS Compatible	SWITCH FUNCTION	
			POS.1	POS.2
OS202013MT5QN1 (Non-shorting)	YES	NO	ON	ON
CONN. TERMINALS			1-2, 4-5	2-3, 5-6
SCHEMATIC				
DPDT				

CONTACT RATING: 0.3A @ 30 VDC



Third Angle Projection

Dimensions are shown: Inch (mm)  
Specifications and dimensions subject to change



# OS Series Miniature Slide Switches

PART NUMBER	ROHS		SWITCH FUNCTION		
	Compliant	Compatible	POS.1	POS.2	POS.3
<b>OS203013MT7QN1</b> (Non-shorting)	YES	NO	ON	OFF	ON
CONN. TERMINALS			1-2, 4-5		2-3, 5-6
SCHEMATIC					
DP3T					

CONTACT RATING: 0.3A @ 30 VDC

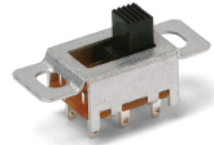
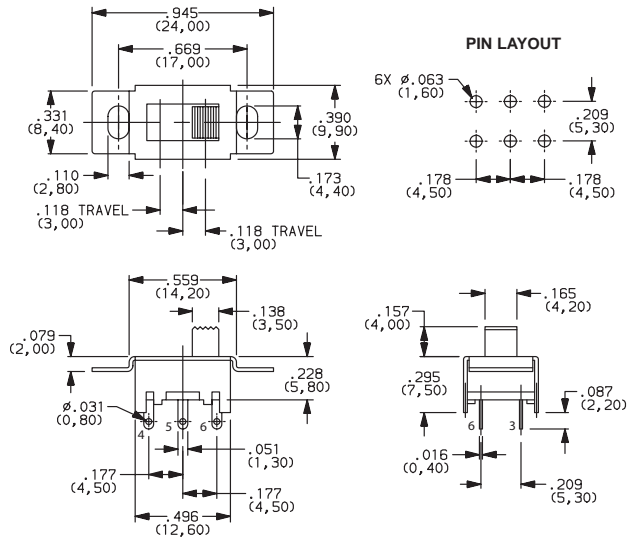

OS203013MT7QN1  
DP3T



PART NUMBER	ROHS		SWITCH FUNCTION	
	Compliant	Compatible	POS.1	POS.2
<b>OS202013MT8QN1</b> (Non-shorting)	YES	NO	ON	ON
CONN. TERMINALS			1-2, 4-5	2-3, 5-6
SCHEMATIC				
DPDT				

CONTACT RATING: 0.3A @ 30 VDC

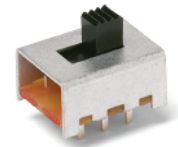
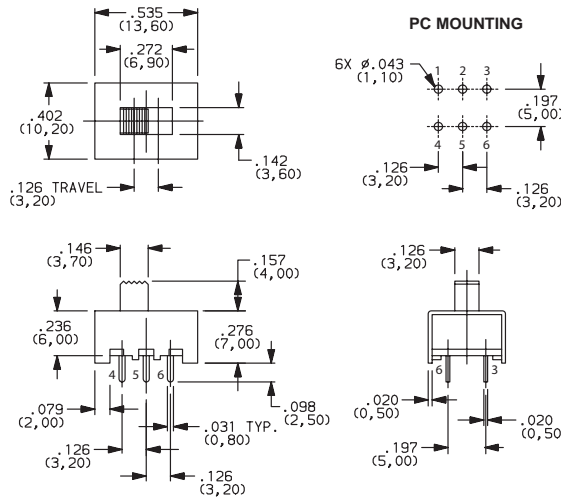

OS202013MT8QN1  
DPDT

PART NUMBER	ROHS		SWITCH FUNCTION		
	Compliant	Compatible	POS.1	POS.2	POS.3
<b>OS203013MT8QN1</b> (Non-shorting)	YES	NO	ON	ON	ON
CONN. TERMINALS			1-2, 5-6	2-3, 6-7	3-4, 7-8
SCHEMATIC					
DP3T					

CONTACT RATING: 0.3A @ 30 VDC

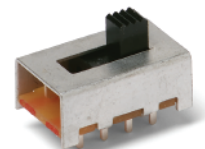
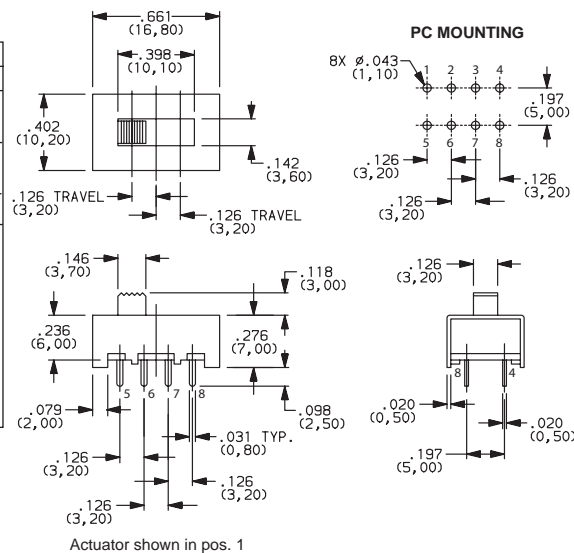

OS203013MT8QN1  
DP3T

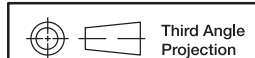

Third Angle Projection

Dimensions are shown: Inches (mm)

Specifications and dimensions subject to change

www.ck-components.com



8 aug 17

# OS Series Miniature Slide Switches

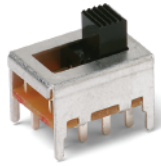

OS203013MT6QN1  
DP3T

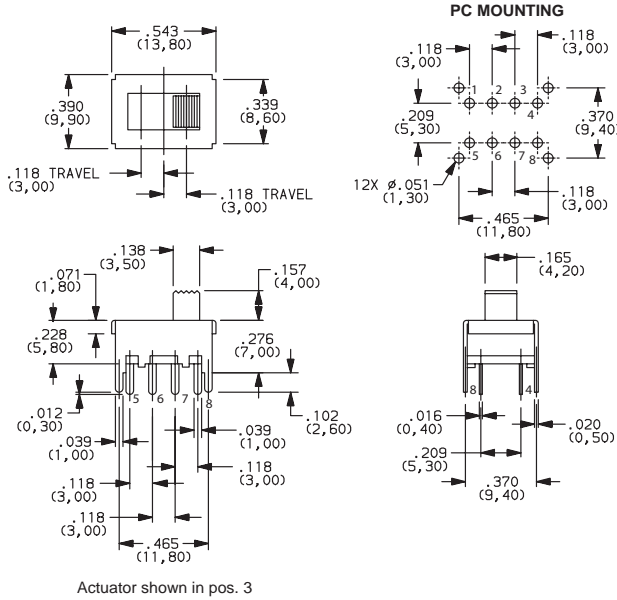

Actuator shown in pos. 3

PART NUMBER	ROHS Compliant	ROHS Compatible	SWITCH FUNCTION		
			POS.1	POS.2	POS.3
OS203013MT6QN1 (Non-shorting)	YES	NO	ON	ON	ON
CONN. TERMINALS			1-2, 5-6	2-3, 6-7	3-4, 7-8
SCHEMATIC					
DP3T					

CONTACT RATING: 0.2A @ 30 VDC

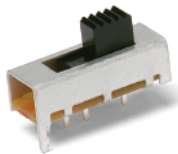

OS103012MU1QP1  
SP3T

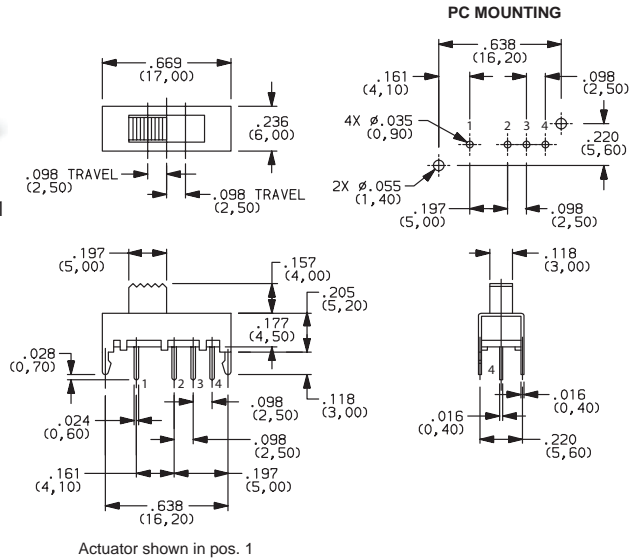

Actuator shown in pos. 1

PART NUMBER	ROHS Compliant	ROHS Compatible	SWITCH FUNCTION		
			POS.1	POS.2	POS.3
OS103012MU1QP1 (Non-shorting)	YES	NO	ON	ON	ON
CONN. TERMINALS			1-2	2-3	2-4
SCHEMATIC					
SP3T					

CONTACT RATING: 0.2A @ 30 VDC

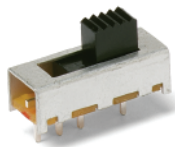

OS103012MU2QP1  
SP3T

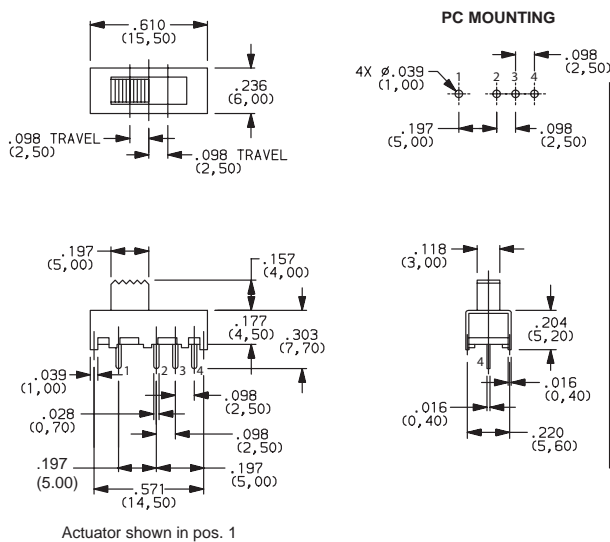

Actuator shown in pos. 1

PART NUMBER	ROHS Compliant	ROHS Compatible	SWITCH FUNCTION		
			POS.1	POS.2	POS.3
OS103012MU2QP1 (Non-shorting)	YES	NO	ON	ON	ON
CONN. TERMINALS			1-2	2-3	2-4
SCHEMATIC					
SP3T					

CONTACT RATING: 0.2A @ 30 VDC

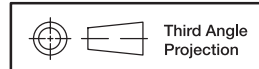

Third Angle Projection

Dimensions are shown: Inch (mm)  
Specifications and dimensions subject to change



Slide

# OS Series Miniature Slide Switches

PART NUMBER	ROHS Compliant	ROHS Compatible	SWITCH FUNCTION		
			POS.1	POS.2	POS.3
<b>OS203012MU5QP1</b> (Non-specified)	YES	NO	ON	ON	ON
CONN. TERMINALS			1-2, 5-6	2-3, 6-7	2-4, 6-8
SCHEMATIC					
DP3T					

CONTACT RATING: 0.1A @ 30 VDC

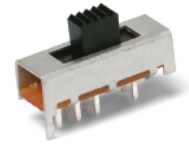
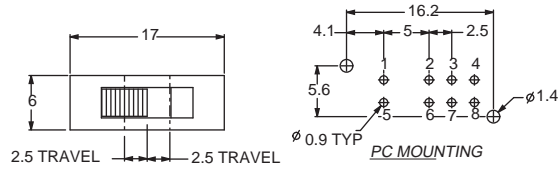

OS203012MU5QP1  
DP3T

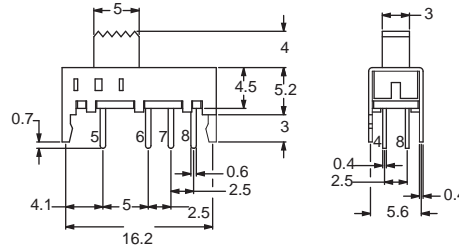

ACTUATOR SHOWN IN POS. 1

PART NUMBER	RoHS Compliant	RoHS Compatible	SWITCH FUNCTION	
			POS.1	POS.2
<b>OS202011MV4QN1</b> (Non-shorting)	YES	NO	ON	ON
<b>OS202011MV4QS1</b> (Shorting)	YES	NO	ON	ON
CONN. TERMINALS			1-2, 4-5	2-3, 5-6
SCHEMATIC				
DPDT				

CONTACT RATING: 0.1A @ 30 VDC

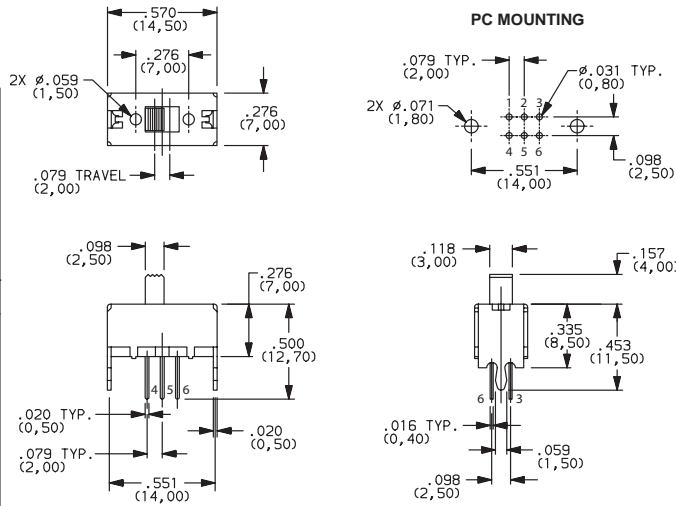

Actuator shown in pos. 1

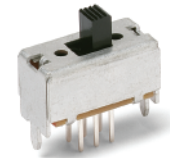

OS202011MV4QN1  
DPDT

PART NUMBER	ROHS Compliant	ROHS Compatible	SWITCH FUNCTION		
			POS.1	POS.2	POS.3
<b>OS203011MV9QS1</b> (Shorting)	YES	NO	ON	ON	ON
<b>OS203011MV9QN1</b> (Non-Shorting)	YES	NO	ON	ON	ON
CONN. TERMINALS			1-2-5 6-7-10	1-3-5 6-8-10	1-4-5 6-9-10
SCHEMATIC					
DP3T					

CONTACT RATING: 0.1A @ 30 VDC

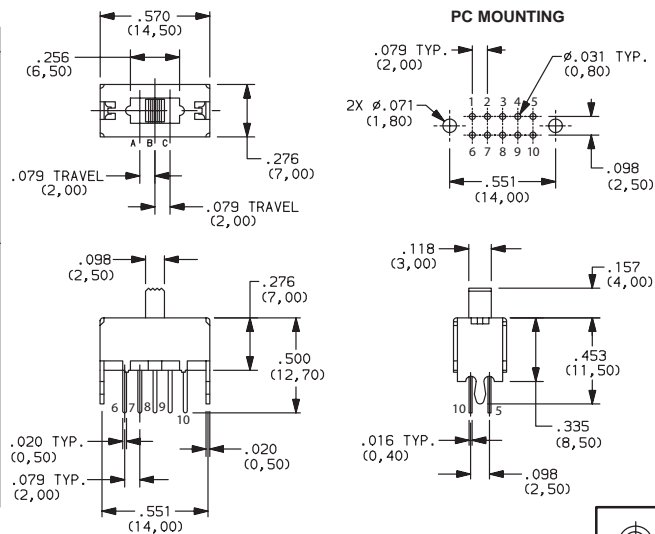

Actuator shown in pos. 2(A)

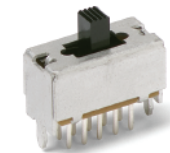

OS203011MV9QS1  
DP3T



Third Angle Projection

Dimensions are shown: Inches (mm)

Specifications and dimensions subject to change

www.ck-components.com



8 aug 17



# OS Series Miniature Slide Switches

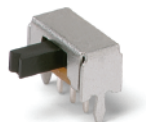

OS102011MA1QN1  
SPDT

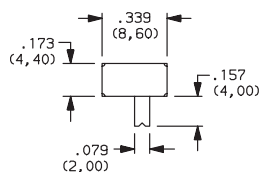

PC MOUNTING

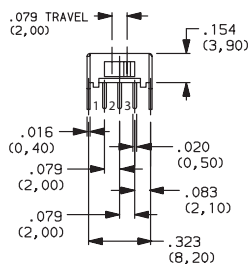
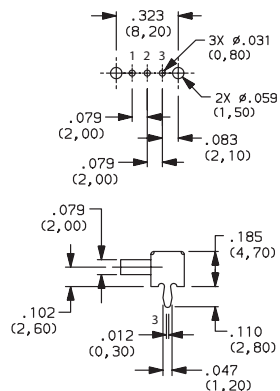

Actuator shown in pos. 2

PART NUMBER	SWITCH FUNCTION		POS.1	POS.2
	RoHS Compliant	RoHS Compatible		
OS102011MA1QN1 (Non-shorting)	YES	NO	ON	ON
OS102011MA1QN1C* (Non-shorting)	YES	YES	ON	ON
OS102011MA1QS1 (Shorting)	YES	NO	ON	ON
OS102011MA1QS1C* (Shorting)	YES	YES	ON	ON
CONN. TERMINALS			1-2	2-3
SCHEMATIC				
<p>SPDT</p>				

CONTACT RATING: 0.1A @ 12 VDC

\* "C" option at the end of part number designates high temperature actuators



OS103011MA7QP1  
SP3T

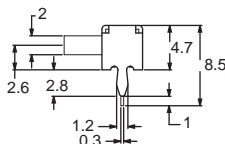
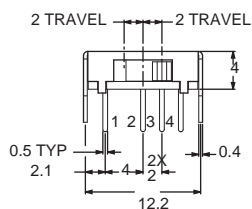
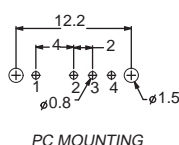
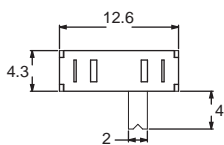

PART NUMBER	SWITCH FUNCTION				
	ROHS Compliant	ROHS Compatible	POS.1	POS.2	POS.3
OS103011MA7QP1 (Non-specified)	YES	NO	ON	ON	ON
OS103011MA7QP1C* (Non-specified)	YES	YES	ON	ON	ON
CONN. TERMINALS			1-2	2-3	2-4
SCHEMATIC					
<p>SP3T</p>					

CONTACT RATING: 0.1A @ 12 VDC

\* "C" option at the end of part number designates high temperature actuators



OS203011MA2QP1  
DP3T

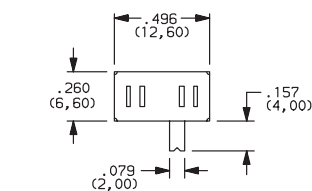

PC MOUNTING

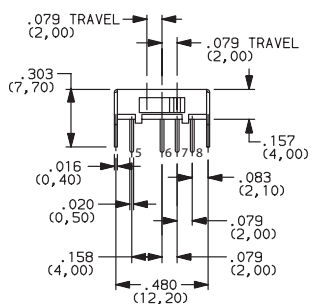
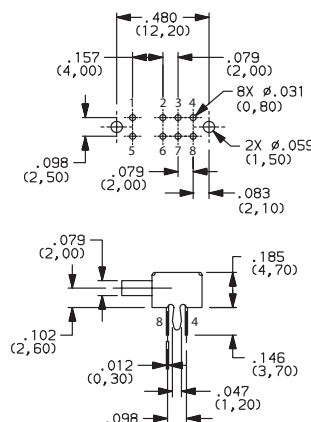

Actuator shown in pos. 3

PART NUMBER	SWITCH FUNCTION				
	ROHS Compliant	ROHS Compatible	POS.1	POS.2	POS.3
OS203011MA2QP1 (Non-specified)	YES	NO	ON	ON	ON
CONN. TERMINALS			1-2, 5-6	2-3, 6-7	2-4, 6-8
SCHEMATIC					
<p>DP3T</p>					

CONTACT RATING: 0.1A @ 12 VDC



Dimensions are shown: Inch (mm)  
Specifications and dimensions subject to change



# OS Series Miniature Slide Switches

PART NUMBER	RoHS Compliant	RoHS Compatible	SWITCH FUNCTION	
			POS.1	POS.2
<b>OS202011MA0QN1</b> (Non-shorting)	YES	NO	ON	ON
<b>OS202011MA0QS1</b> (Shorting)	YES	NO	ON	ON
CONN. TERMINALS			1-2, 4-5	2-3, 5-6
SCHEMATIC				
DPDT				

CONTACT RATING: 0.1A @ 12 VDC

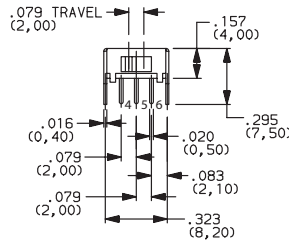
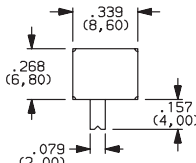

Actuator shown in pos. 1

## PC MOUNTING

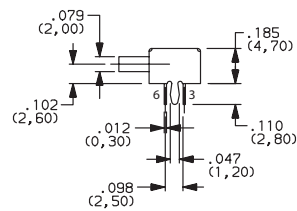
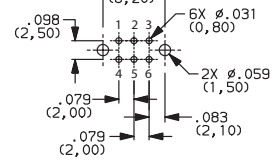

OS202011MA0QN1  
DPDT

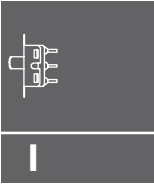

Slide

## X-ON Electronics

Largest Supplier of Electrical and Electronic Components

*Click to view similar products for [Toggle Switches](#) category:*

*Click to view products by [C&K](#) manufacturer:*

Other Similar products are found below :

[8A1-C-222](#) [60012L](#) [6006L](#) [6663](#) [7101MD9V30GE](#) [7101SPDV30BE](#) [7103SDV30BE](#) [7105D](#) [7108P3YAV2BE](#) [71YY50282](#)  
[7201MD9AVBE](#) [7301K38](#) [7306K36](#) [7310K36](#) [7314K36](#) [7506K4](#) [7592K6](#) [7691K14](#) [7700K1](#) [8396K108](#) [8824K14](#) [8828K13](#) [G2VX](#) [G3VX](#)  
[PS83-121G](#) [A101MD9AB04](#) [A101SD9AB04](#) [A101SDCQ04](#) [A103SD9AQ04](#) [A107TZB04](#) [A123P32YZQ](#) [A123S1YZG](#) [A127S1YCQ](#) [1-](#)  
[1825192-0](#) [A131S1YZQ](#) [A201SCWZB04](#) [A207SYCB04](#) [A208J61ZQ0004](#) [A221K12KAG](#) [A221S1YZQ](#) [A221T1TCQ](#) [A232K12KZQ](#)  
[A232M1YCQ](#) [A323S1CWZQ](#) [A423S1CWZG-M8](#) [A423S1YZQ](#) [12149A-3V](#) [12156AX408](#) [12147AGKX679](#) [12149AD2G0383VX408](#)