



PLP16 Series Panel Mount LED Sealed Pushbutton Switch

NEW

Pushbutton
A

Features/Benefits

- Illuminated & non-illuminated type
- Momentary or lock version
- IP65 or IP40 sealed
- 1,000,000 life cycle
- Choices of colors on LED illumination
- Various actuator sizes and styles
- Withstand high shock and vibration application

Typical Applications

- Industrial control panel
- Off-road transportation
- Machine and equipment
- Production control indicator



Specifications

FUNCTION: SPDT or DPDT
CONTACT ARRANGEMENT: N.O. AND N.C.
MOUNTING TYPE: Threaded front panel mount

Mechanical

OPERATING LIFE: Momentary 1,000,000 cycles
Lock 100,000 cycles
TOTAL TRAVEL: 1.2 ± 0.3 mm
OPERATING FORCE: 3.0 max.

Electrical

CONTACT RATING: 1th 5A / 250 VAC
3A / 250 VAC
1A / 30 VDC
OPERATING LIFE: Momentary 100,000 cycles
Lock 50,000 cycles
DIELECTRIC STRENGTH: 2,000 V RMS @ sea level
INSULATION RESISTANCE: 100 MΩ min. @ 500 VDC
INITIAL CONTACT RESISTANCE : 50 mΩ max. initial value

Materials

BUSHING: PEI
BASE / LED holder: PBT
ACTUATOR: PC
INTERNAL ASSEMBLY: POM / PC
SPRING: Steel (SUS304)
SEALING / O-ring: Silicone
TERMINALS / CONTACT: Brass (C2680) / Phosphorus Bronze, Silver or Gold over Silver plated

Operating Environment

OPERATING TEMPERATURE: -25°C to 55°C
SEALING / PROTECTION: IP65 or IP40

NOTE: Specifications and materials listed above are for switches with standard options. For information on specific and custom switches, please contact Customer Service.

Build-A-Switch

To order, simply select desired option from each category and place in the appropriate box.



Switch Type

Illuminated PB / Pilot light (Apply voltage)	Non-illuminated PB (CAP options)
00 Without LED	C1 Solid color
06 6 VAC/DC	C2 Transparent
12 12 VAC/DC	
24 24 VAC/DC	

Actuator Style *

- RD** Round
- SQ** Square
- TA** Rectangular
- RV** Round oversize
- SV** Square oversize
- TV** Rectangular oversize
- TG** Rectangular guard

Actuator Color

- 2** White
- 3** Red
- 4** Black **
- 5** Yellow
- 6** Green
- 7** Blue
- 8** Orange ***

IP Rating

- 4** IP40
- 6** IP65

Mechanical Function

- A** Momentary
- E** Lock
- N** Pilot light

Contact Arrangement

- S** SPDT
- D** DPDT
- P** Pilot light

* Pilot light & C2 CAP available on RD, SQ, or TA actuator style only

** For C1 CAP only

*** Not available on C1 CAP



NEW

PLP16 Series Panel Mount LED Sealed Pushbutton Switch



A

Pushbutton

STANDARD VIEW / SWITCH TYPE

ILLUMINATED Ø 5/8" (16 MM)

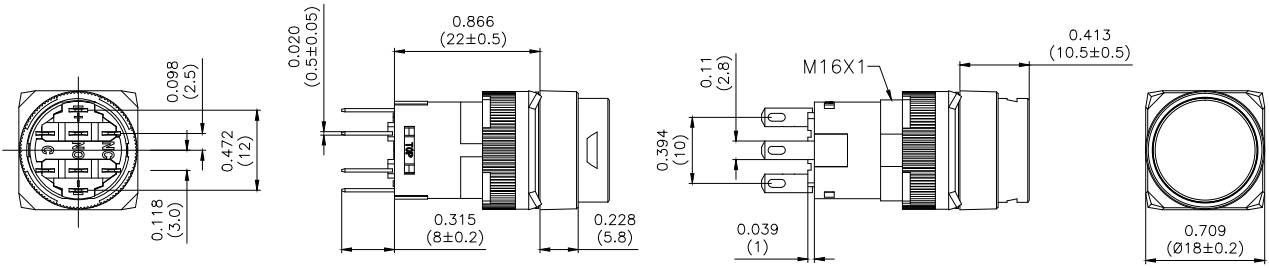

PUSHBUTTON Ø 5/8" (16 MM)

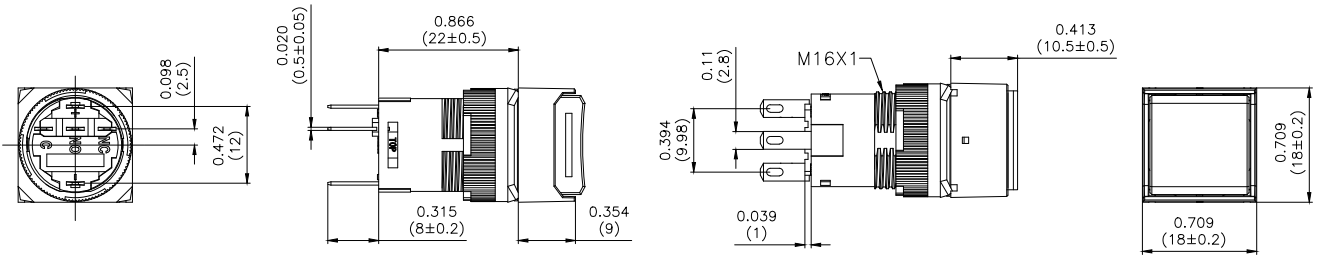

PILOT LAMP Ø 5/8" (16 MM)

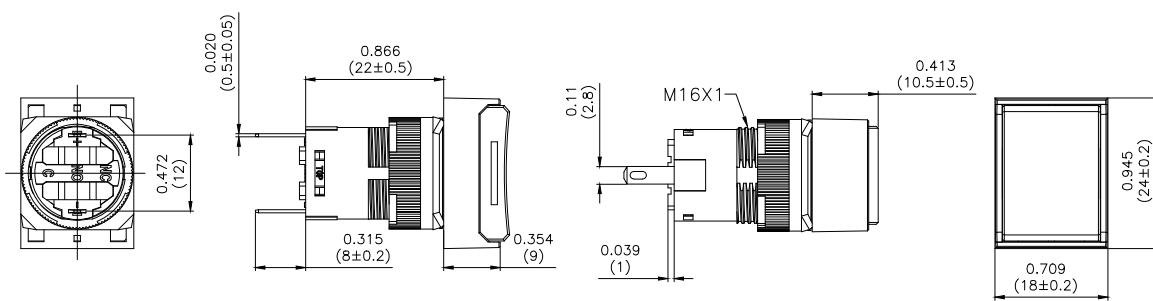

ACTUATOR STYLE / CAP SIZE

RD ROUND

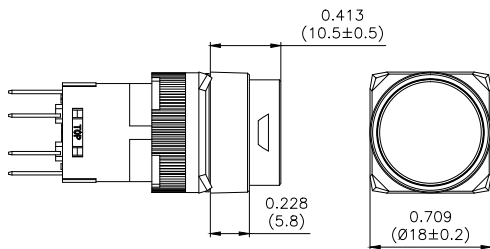

SQ SQUARE

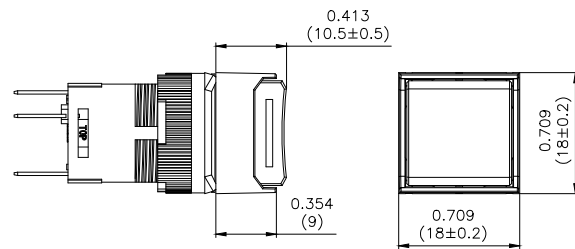

TA RECTANGULAR

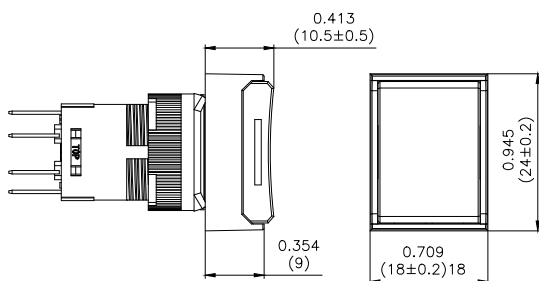

RV ROUND OVERSIZE

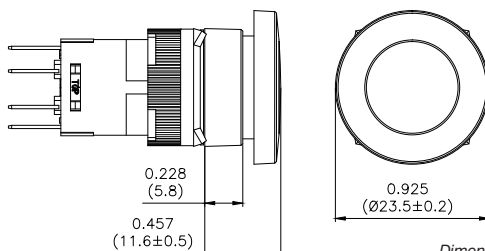

Dimensions are shown: mm (inches)
Specifications and dimensions subject to change

NEW

PLP16 Series Panel Mount LED Sealed Pushbutton Switch



A

Pushbutton

ACTUATOR STYLE / CAP SIZE

SV SQUARE OVERSIZE

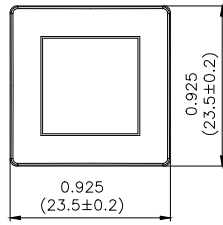
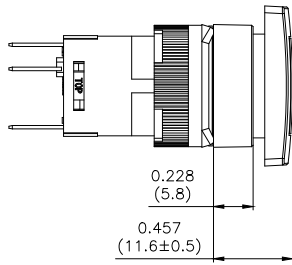

TV RECTANGULAR OVERSIZE

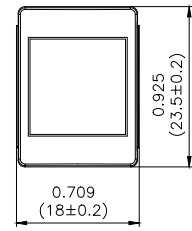
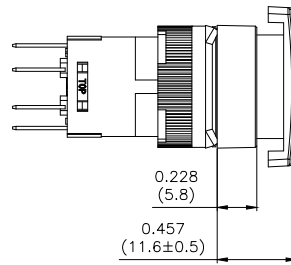

TG RECTANGULAR WITH GUARD

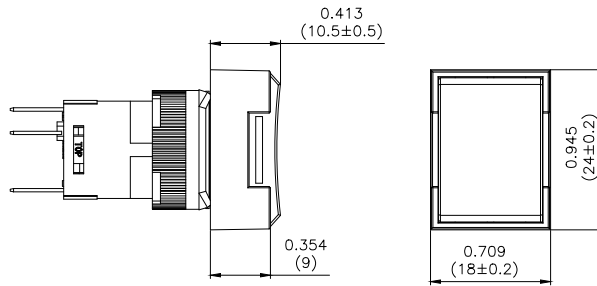

CONTACT ARRANGEMENT

S SPDT



D DPDT

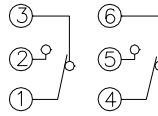

P PILOT LIGHT

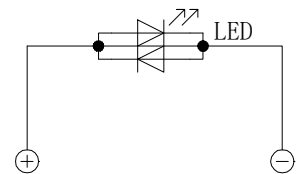

PUSHBUTTON

ILLUMINATED

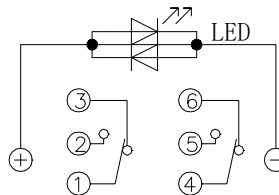
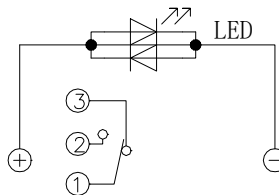

MOUNTING HOLES LAYOUT

ROUND / SQUARE

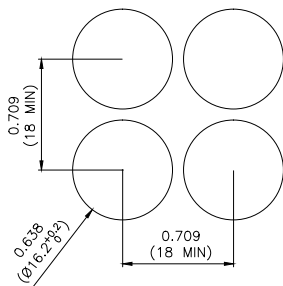

**RECTANGULAR
(PLUS FULL GUARD & OVERSIZE)**

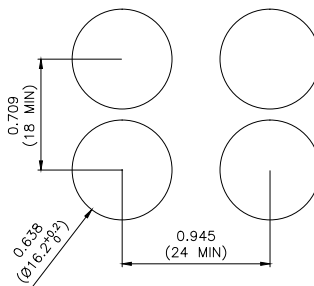

OVERSIZE ROUND & SQUARE

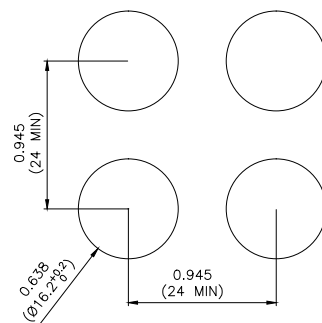

Mounting panel thickness reference dia: 0.5-0.6 mm

Dimensions are shown: mm (inches)
Specifications and dimensions subject to change

NEW

PLP16 Series Panel Mount LED Sealed Pushbutton Switch

**A**
Pushbutton

LED - LAMP RATING

Voltage Range		6V AC/DC \pm 5%	12V AC/DC \pm 10%	24V AC/DC \pm 10%
Rated Voltage		6V AC/DC	12V AC/DC	24V AC/DC
Current Draw	DC	8 mA	8 mA	8 mA
	AC	9 mA	9 mA	9 mA
Lamp Base Color / Lamp Body Resin Color		Illumination color / Porcelain white		
Life (reference value)		50,000 hours (brightness of LED lamp will half of the initial value when using DC only)		

ACCESSORY ORDERING INFORMATION

LED LAMP

	Rated Voltage	Ordering Code
	6V AC/DC	PL06X *
	12V AC/DC	PL12X *
	24V AC/DC	PL24X *

* X = choice of LED color

X	Color
2	White
3	Red
5	Yellow
6	Green
7	Blue
8	Orange

SWITCH PROTECTIVE GUARD FOR IP65 (180° SPRING RETURN COVER)#

**ROUND
PCS651****SQUARE
PCS652****RECTANGULAR
PCS653**

SWITCH PROTECTIVE GUARD FOR IP40 & IP65

Rated	Cover Opening	For Actuator Type	Ordering Code	Rated	Cover Opening	For Actuator Type	Ordering Code
	90°	Round / Square	PC401		90°	Round / Square	PC654
		Rectangular	PC402			Rectangular	PC655
	180°	Round / Square	PC403		180°	Round / Square	PC656
		Rectangular	PC404			Rectangular	PC657

Refer to spec for panel cutout dimensions and mounting instruction

X-ON Electronics

Largest Supplier of Electrical and Electronic Components

Click to view similar products for [Pushbutton Switches](#) category:

Click to view products by [C&K](#) manufacturer:

Other Similar products are found below :

[8940K2012](#) [8971K1133](#) [LW1L-M1C10V-A](#) [LW1L-M1C70-A](#) [LW2L-A1C20M-GD](#) [LW2L-M1C20M-A](#) [60324L](#) [M22-D-R-GB0/K11](#) [M7E-HRN2](#) [67021K512](#) [67081K512X](#) [701PB580](#) [7199K101](#) [810K12910](#) [810KSV30B](#) [MML21EA2ADK](#) [MML21KA3ABK](#)
[MML23KA3AC05K-001](#) [MML23KW3AA01W](#) [8418K2](#) [8442K3](#) [8450K1](#) [860K11911T01A](#) [861901](#) [861K11911T01A07](#)
[861K13810T00A14](#) [861K13911](#) [8646AB6X718UL](#) [8646ABUL](#) [9001KXRK](#) [907AYY100](#) [PMHD155A1](#) [9533CD4+U574+U4922](#) [95-414.000](#) [99-450.837](#) [99-453.837](#) [PV3H2B0NN-341](#) [1203MRA](#) [A22NZBGANGA](#) [A22NZBNANGA](#) [A22NZMPATRA](#) [A2PMA1X03EC56](#)
[A3A-5123-02](#) [A3A-7140](#) [A3A-7310](#) [A3A-7340](#) [A3U-TMW-A2C-5M](#) [A595](#) [12037A2ULCSA](#) [ABD122N-B](#)