

# PN Series Alternate & Momentary Action Pushbutton Switches



## Features/Benefits

- Momentary or locking action
- Different actuation forces for customized feel
- Low cost, reliable contact design
- Single and double pole options
- RoHS compliant

## Typical Applications

- Computers and peripherals
- Instrumentation and measurement equipment
- Non-power, on-off switch applications



## Specifications

CONTACT RATING: 0.2 AMP @ 30 V DC max.  
 ELECTRICAL LIFE: 10,000 make-and-break cycles at full load.  
 MECHANICAL LIFE: 10,000 on/off cycles.  
 CONTACT RESISTANCE: 30 mΩ max. initial  
 INSULATION RESISTANCE: 100 MΩ min.  
 DIELECTRIC STRENGTH: 500 V AC min.  
 OPERATING/STORAGE TEMPERATURES: -10°C to 60°C.  
 PACKAGING: Switches are supplied in anti-static trays.

## Materials

FRAME: Tin plated steel.  
 ACTUATOR: PA 66 black.  
 BASE: Phenolic resin.  
 TERMINALS: Silver plated brass.  
 MOVABLE CONTACTS: Silver plated phosphor bronze.  
 RETURN SPRING: SWC  
 DETENT SPRING: Phosphor bronze.  
 DETENT SPRING PLATE: Phosphor bronze.  
 RETURN SPRING RETAINER RING: Nickel plated steel.  
 TERMINAL SEAL: Epoxy.

## Build-A-Switch

To order, simply select desired option from each category and place in the appropriate box. For additional options not shown in catalog, consult Customer Service Center.

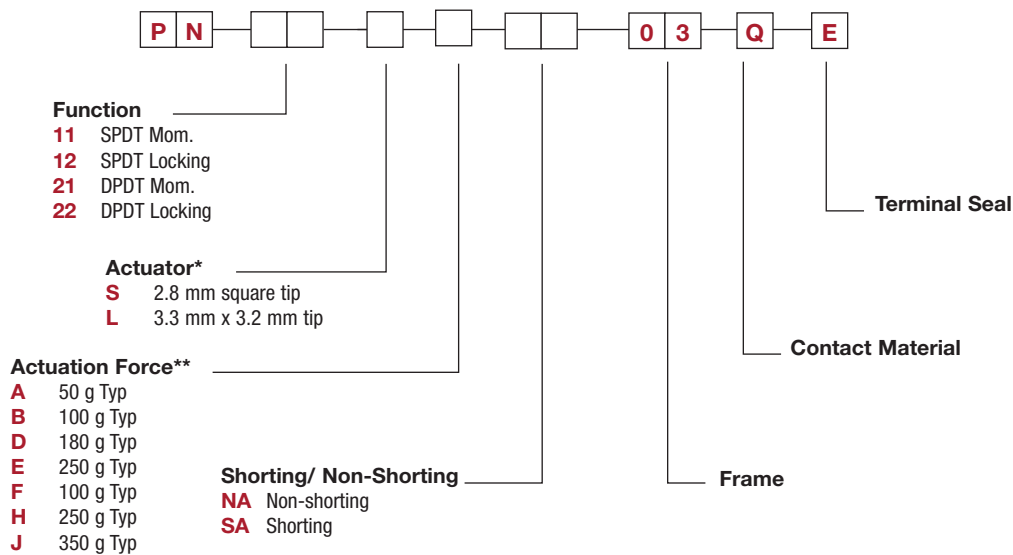

\* Note - The switch body style dimensions differ for each of these 3 groupings

"S" actuator available for PN 11 & PN 12 options

"S" actuator available for PN 21 & PN 22 options

"L" actuator available for PN 21 & PN 22 options

\*\* Actuation Force "A" only available with PN11 with "S" actuator

PN 11 & PN 21 available with Actuation Force "B", "D", "E", "F", "H", "J"

PN 12 & PN 22 available with Actuation Force "D", "E", "H", "J"

Full travel



# PN Series Alternate & Momentary Action Pushbutton Switches

Pushbutton

A

**PN 11** SPDT Mom.  
**PN 12** SPDT Locking

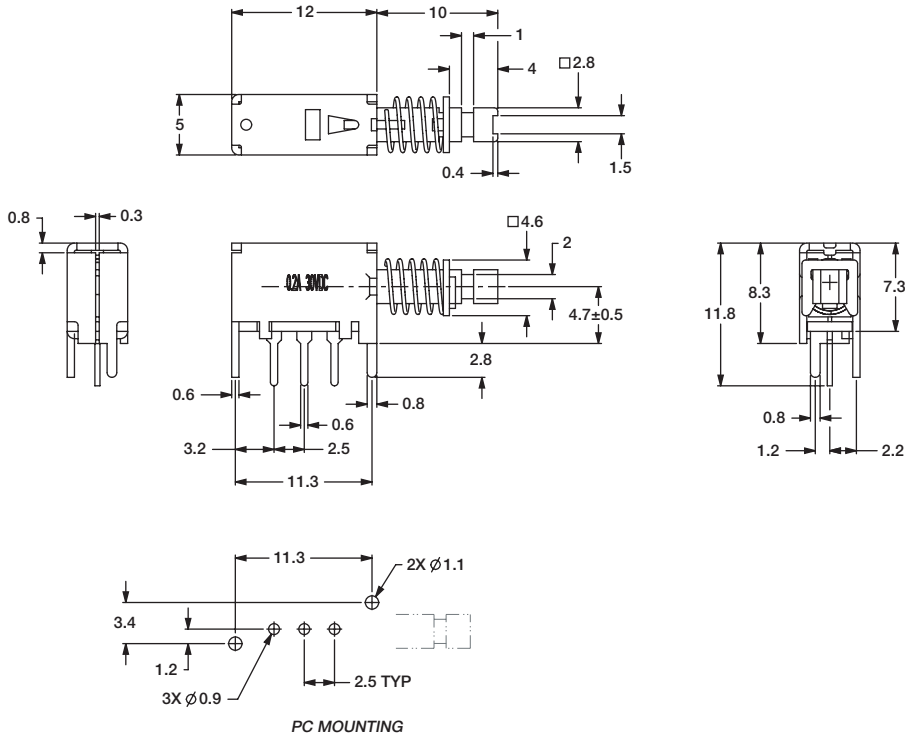

**PN 21** DPDT Mom. with "S" Actuator  
**PN 22** DPDT Locking with "S" Actuator

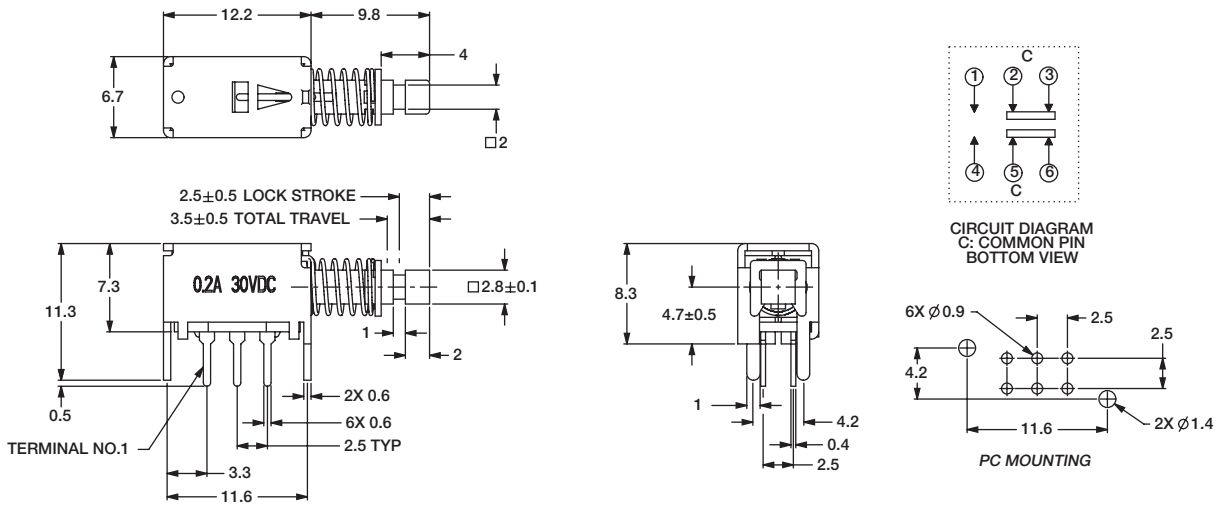

Dimensions are shown: mm  
Specifications and dimensions subject to change



# PN Series Alternate & Momentary Action Pushbutton Switches



A  
Pushbutton

**PN 21** DPDT Mom. with "L" Actuator  
**PN 22** DPDT Locking with "L" Actuator

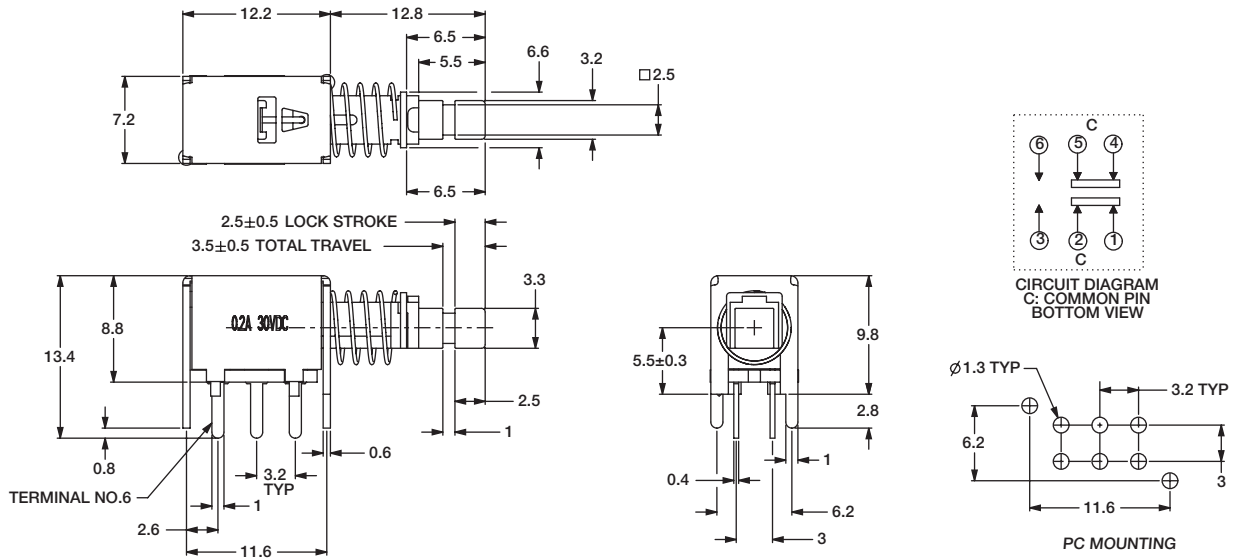

**BUTTONS MUST BE ORDERED SEPARATELY. SHIPPED IN BULK.**

## PE

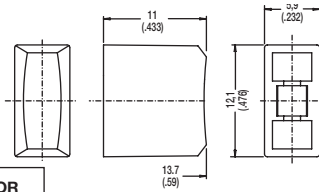

| OPTION CODE | COLOR |
|-------------|-------|
| <b>RD</b>   | Red   |
| <b>GY</b>   | Gray  |
| <b>BK</b>   | Black |
| <b>WH</b>   | White |

PE and PV buttons fit "L" actuators

## PV

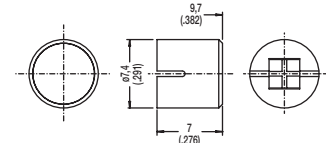

## Indexed

- G001A** Black
- G001G** Gray
- G001I** Ivory
- G001R** Red

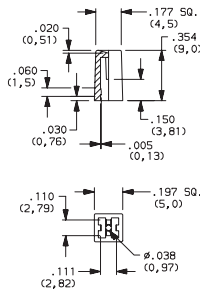
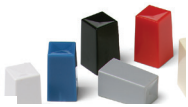

## Rectangular

- G002A** Black
- G002G** Gray
- G002I** Ivory
- G002R** Red

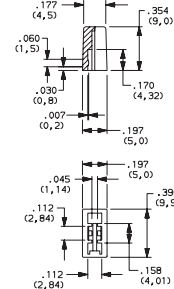

## Round

- G003A** Black
- G003G** Gray
- G003I** Ivory
- G003R** Red



G001, G002, G003 and G004 buttons fit "S" actuators

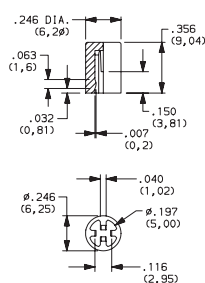

## Square

- G004A** Black
- G004G** Gray
- G004I** Ivory
- G004R** Red

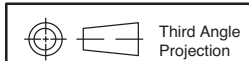
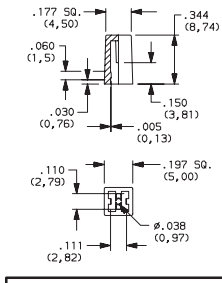

Dimensions are shown: Inches (mm)  
 Specifications and dimensions subject to change

## X-ON Electronics

Largest Supplier of Electrical and Electronic Components

*Click to view similar products for [Pushbutton Switches](#) category:*

*Click to view products by [C&K](#) manufacturer:*

Other Similar products are found below :

[LW1L-M1C10V-A](#) [LW2L-A1C20M-GD](#) [LW2L-M1C20M-A](#) [60324L](#) [M7E-HRN2](#) [67021K512](#) [67081K512X](#) [701PB580](#) [719-5504-000](#)  
[MDPSSGLFS](#) [810KSV30B](#) [FLT 2U EE 01A](#) [MML21KA3ABK](#) [MML23KA3AC05K-001](#) [MML23KW3AA01W](#) [8418K2](#) [8646AB6X718UL](#)  
[8646ABUL](#) [FSDWH](#) [9001KXRK](#) [9001T8BK](#) [9533CD4+U574+U4922](#) [1203MRA](#) [A22EM01S](#) [A595](#) [12037A2ULCSA](#) [1203A2UL](#)  
[ABD122N-B](#) [1211390004](#) [ABN111-Y](#) [ABN400-R](#) [1211500044](#) [1211580012](#) [1212MRA](#) [1232A6NF](#) [1241.1183.7047](#) [1241.2511](#) [1241.3428](#)  
[1223A2ULCSA](#) [1223MRA](#) [1232AX2119](#) [1241.1183.8000](#) [1241.1183.8029](#) [1241.2506](#) [1241.2606](#) [12MA6](#) [1301940184](#)  
[RELBARF6X10\(PLASTIC\)](#) [13435AG](#) [13440AD2G25X822+U4546](#)