

PTS645 Series 6 mm Tact Switches



Features/Benefits

- Compact size 6 x 6 mm
- Variety of actuator lengths
- Choice of actuation force
- RoHS compliant and compatible

Typical Applications

- Consumer products
- Instrumentation
- Computer products
- Industrial

Tactile Switches

B

Specification

FUNCTION: Momentary action
CONTACT ARRANGEMENT: SPST, N.O.
TERMINALS: PC pins

Mechanical

ACTUATION FORCE: 130 grams, 160 grams, 200 grams, 260 grams
LIFE EXPECTANCY: 100,000 operations.

Electrical

CONTACT RATING: 50 mA @ 12 V DC.
DIELECTRIC STRENGTH: 250 V AC min.
CONTACT RESISTANCE: 100 mΩ max. initial.
INSULATION RESISTANCE: 10¹¹ Ω min.

Environmental

OPERATING TEMPERATURE:
- Thru-hole and SMT with J actuator shape: -20°C to 70°C
- SMT (except for J actuator shape): -20°C to 85°C

Process

SOLDERING: Preheating to 100°C for 45 sec. max. Keep flux flush with top surface of PCB; do not apply to component side of PCB and area where terminals are located. Soldering to 255°C for 5 sec. max. Clean by brushing on solder surface. Do not clean switch with solvents.

Packaging

Bulk packaging.

Tape & reel for the SMT type:

Reels of 1,000 pieces for 4.3 and 5.0 mm height
Reels of 700 pieces for 7.0 mm height
Reels of 700 pieces for 7.3 mm height
Reels of 500 pieces for 9.5 mm height
Reels of 400 pieces for 13.0 mm height

NOTE: Specifications listed above are for switches with standard options.
For information on specific and custom switches, consult Customer Service Center.

How To Order

Our easy build-a-switch concept allows you to mix and match options to create the switch you need. To order, select desired option from each category and place it in the appropriate box.

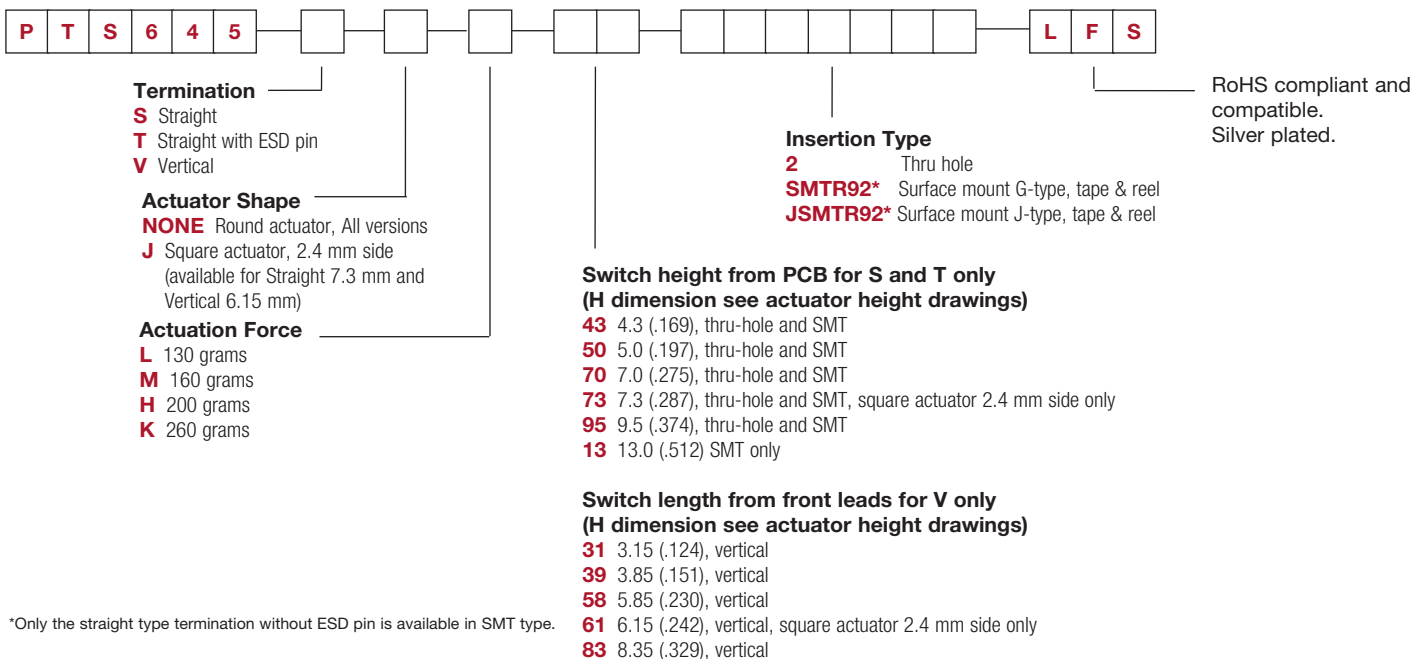

*Only the straight type termination without ESD pin is available in SMT type.



TERMINATION

S STRAIGHT

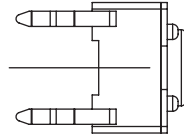

SCHEMATIC

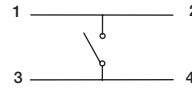

PCB LAYOUT



T STRAIGHT WITH ESD PIN

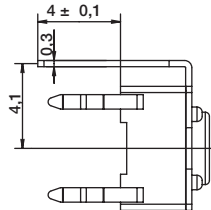
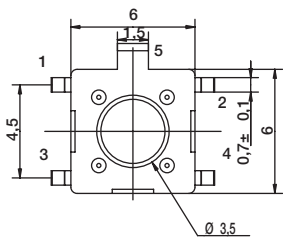
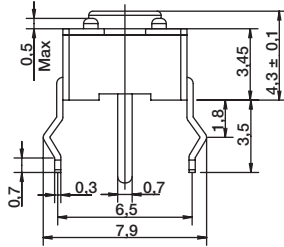

SCHEMATIC

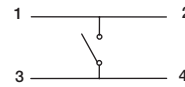

PCB LAYOUT

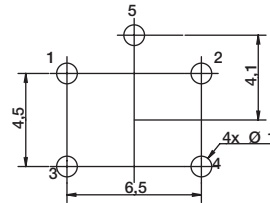

V VERTICAL

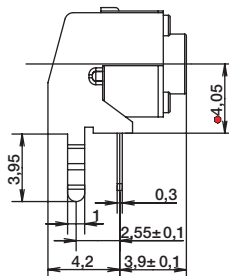

SCHEMATIC

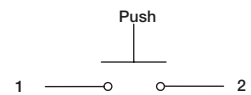

PCB LAYOUT

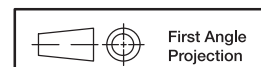

Dimensions are shown: mm
Specifications and dimensions subject to change

PTS645 Series 6 mm Tact Switches

TERMINATION

SMT G Type

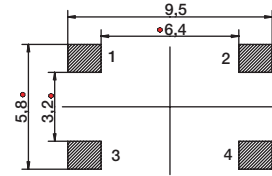
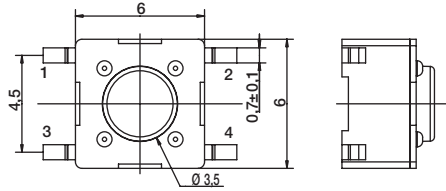
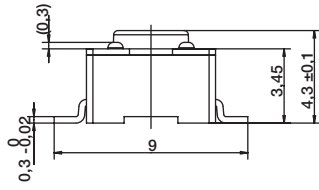

PCB LAYOUT

SMT J Type

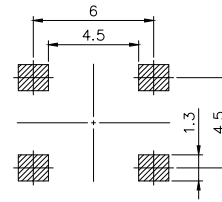
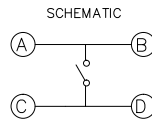
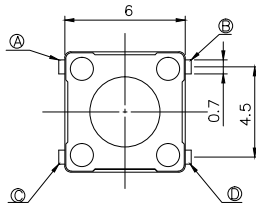

PCB LAYOUT

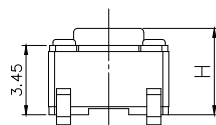
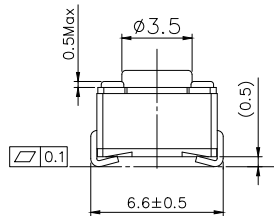

Dimensions are shown: mm
Specifications and dimensions subject to change

ACTUATOR SHAPE

J SQUARE ACTUATOR

VERTICAL THT - FOR 6.15MM LENGTH ONLY

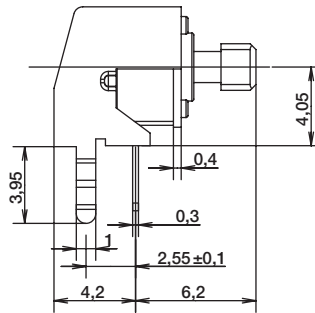
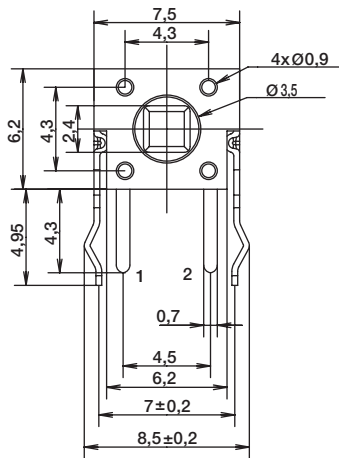
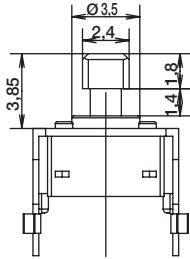

SCHEMATIC

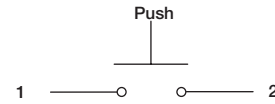

RECOMMENDED PCB LAYOUT

VERTICAL THT - FOR 7.3MM HEIGHT ONLY

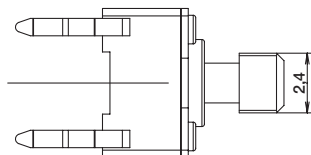
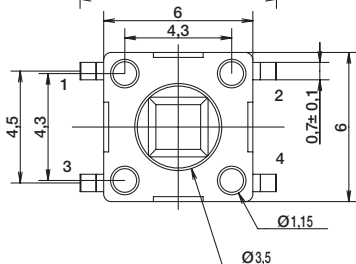
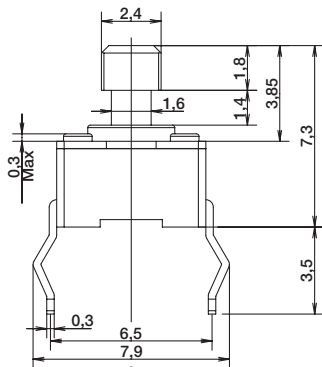

SCHEMATIC



RECOMMENDED PCB LAYOUT

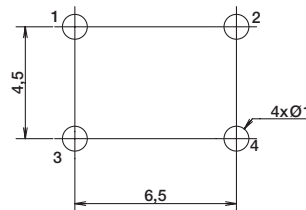

First Angle
Projection

PTS645 Series 6 mm Tact Switches

ACTUATOR SHAPE

STRAIGHT SMT G TYPE - FOR 7.3MM HEIGHT ONLY

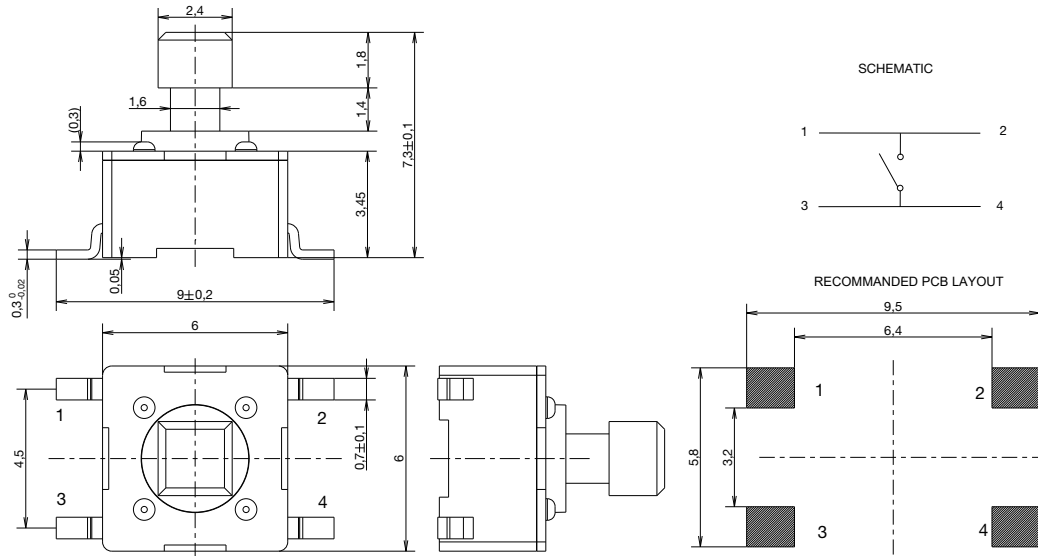

STRAIGHT SMT J TYPE - FOR 7.3MM HEIGHT ONLY

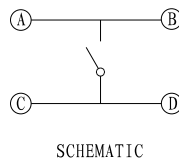
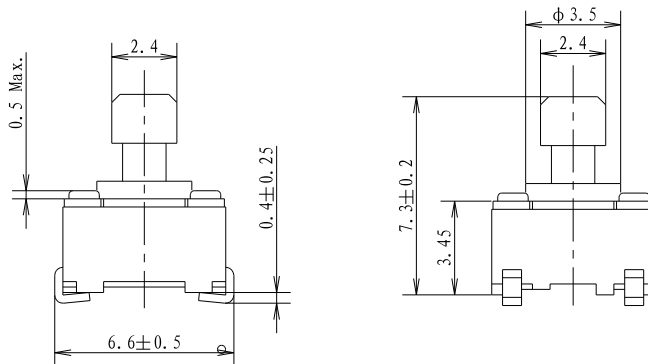
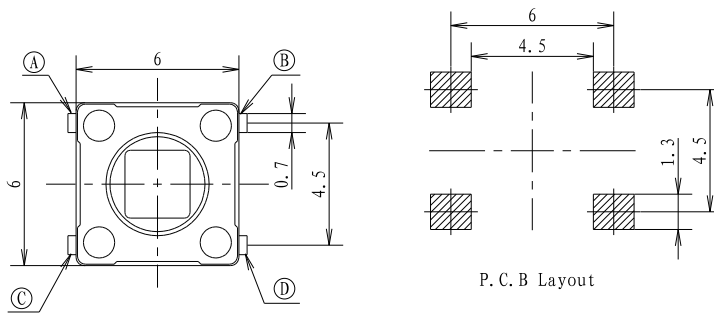

Dimensions are shown: mm
Specifications and dimensions subject to change

ACTUATOR SHAPE

VERTICAL THT - FOR 7.3MM HEIGHT ONLY



SCHEMATIC

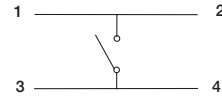

RECOMMENDED PCB LAYOUT

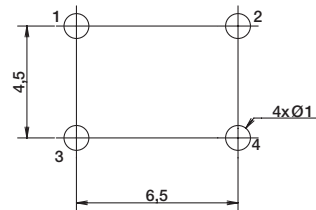

STRAIGHT SMT - FOR 7.3MM HEIGHT ONLY

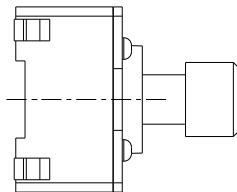

SCHEMATIC



RECOMMENDED PCB LAYOUT

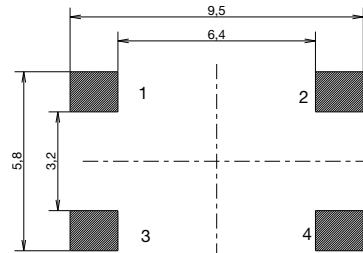

First Angle
Projection

PTS645 Series 6 mm Tact Switches

ACTUATION FORCE

OPTION CODE	FORCE
L	130 grams Black
M	160 grams Blue
H	200 grams Gray
K	260 grams Red

Tactile Switches

ACTUATOR HEIGHT

Switch height from PCB for S and T only

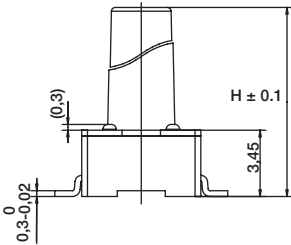

OPTION CODE	DIMENSION H	TERMINATION	SCHEMATIC	
			Without EMC pin	With EMC pin
43	4,3 (.169)	Thru-hole and SMT		
50	5,0 (.197)	Thru-hole and SMT		
70	7,0 (.275)	Thru-hole and SMT		
95	9,5 (.374)	Thru-hole and SMT		
13	13,0 (.512)	SMT		

Switch length from front leads for V only

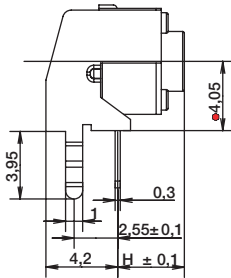

OPTION CODE	DIMENSION H	TERMINATION	SCHEMATIC	
			Without EMC pin	With EMC pin
31	3,15 (.124)	Vertical		
39	3,85 (.151)	Vertical		
58	5,85 (.230)	Vertical		
83	8,35 (.329)	Vertical		

TAPE & REEL FOR SMT G TYPE VERSIONS

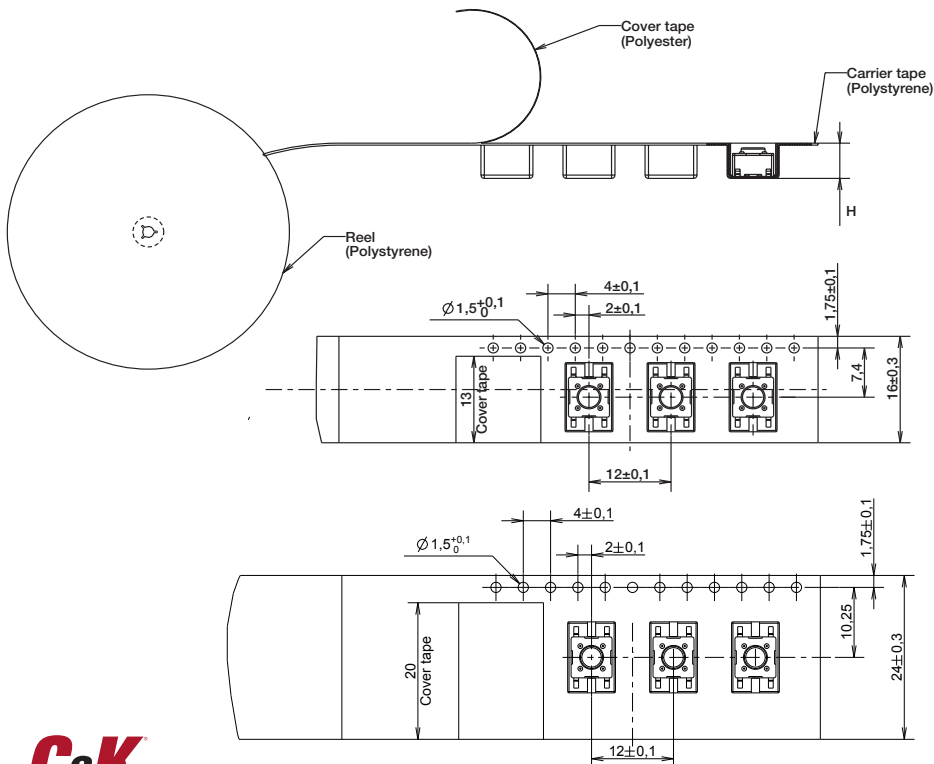

OPTION CODE	WIDTH TAPE	POCKET HEIGHT
43	16 ± 0.3	5.3
50	16 ± 0.3	5.3
70	16 ± 0.3	7.3
73	16 ± 0.3	7.6
95	24 ± 0.3	10.3
13	24 ± 0.3	13.3



Dimensions are shown: mm

Specifications and dimensions subject to change



14 Apr 20

TAPE & REEL FOR SMT J TYPE VERSIONS

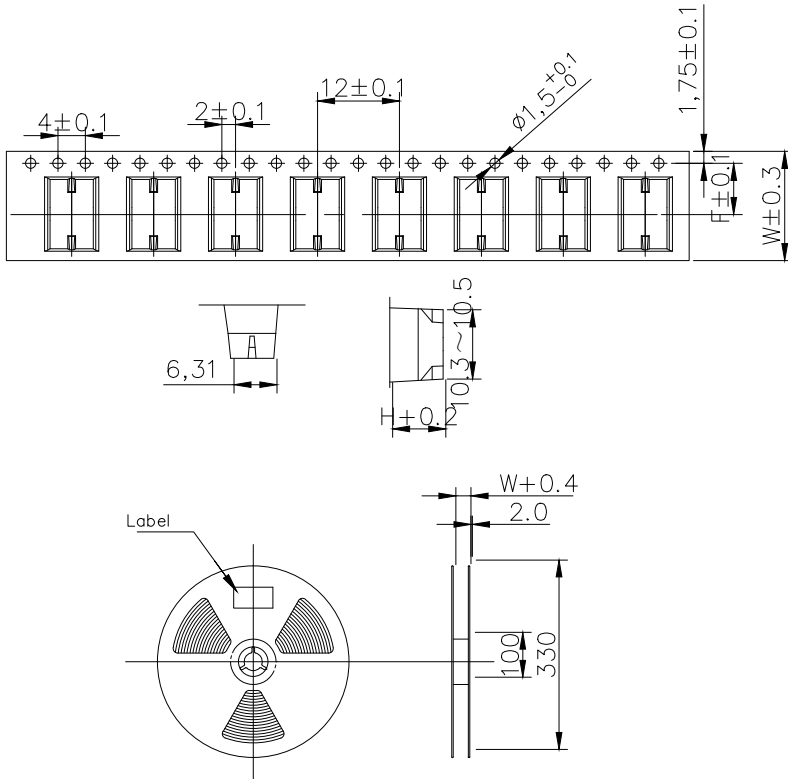

Tape specifications

Product height (H)mm	Carrier tape width (W)mm	Center distance of carrier tape (F)mm	pcs/reel
4.3	16	7.5	1000
5.0	16	7.5	1000
7.0	16	7.5	700
7.3	16	7.5	700
9.5	24	11.5	500
11	24	11.5	500
13	24	11.5	500

Note: The disc rotates counterclockwise. According to the packing shown in the figure, the braid must not be twisted to prevent product deformation;

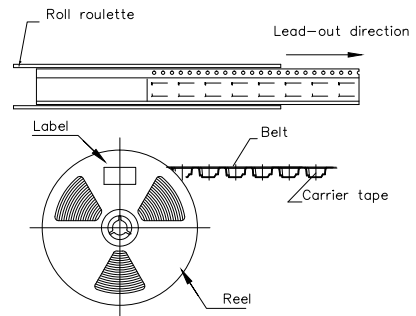

Tactile Switches

X-ON Electronics

Largest Supplier of Electrical and Electronic Components

Click to view similar products for C&K manufacturer:

Other Similar products are found below :

[ESMK1215NCL130](#) [QS1 KQS1 BK S C 773302263](#) [473202000](#) [479603000](#) [4151](#) [SERU AU BRAUN](#) [7101J50V5QE2](#) [7101K2CWZBE](#)
[7101MD9ABE2](#) [7101SDV7QE](#) [7101SDZBE2](#) [7103T1CWV3GE](#) [7105K2CWZQE](#) [7105TCWZBES](#) [7108J2ZQE1](#) [7201TCWCBE](#)
[7203MCWCQE](#) [7203T1ZQE](#) [7207SYCBE](#) [7208L41YZQE](#) [7211SPY3AV2SE2](#) [7215J1AV2BE2](#) [7215JBV6BE](#) [7215L3YZQE](#)
[ET05LD1AGE](#) [ET05MD1AVBE](#) [7401J3ZQE3](#) [7411J3ZQE1](#) [752708000](#) [FA0115RN02Q](#) [8161LHZ3QE22](#) [8161LHZQE2](#) [FLT 2U EE 01A](#)
[MMGGF5L0T](#) [MP01R133CBE](#) [GT11MV3BE](#) [A10403RNZQE](#) [1.20123.0050000](#) [A11205RNZQ](#) [A20303RNCG](#) [A30415RSCG](#) [12TL402](#)
[ADPFF3J04AW](#) [1.30070.0011002](#) [1.30073.6200200](#) [DM22J11S205PQ](#) [DT450T](#) [E101J3V31QE2](#) [E101JAAV2QE](#)